

THIS DOCUMENT IS THE PROPERTY OF
KEYSTONE ELECTRONICS CORP. AND
SHALL NOT BE REPRODUCED, DISTRIBUTED
OR USED AS A BASIS FOR MANUFACTURE
WITHOUT PRIOR WRITTEN PERMISSION
FROM KEYSTONE ELECTRONICS CORP.

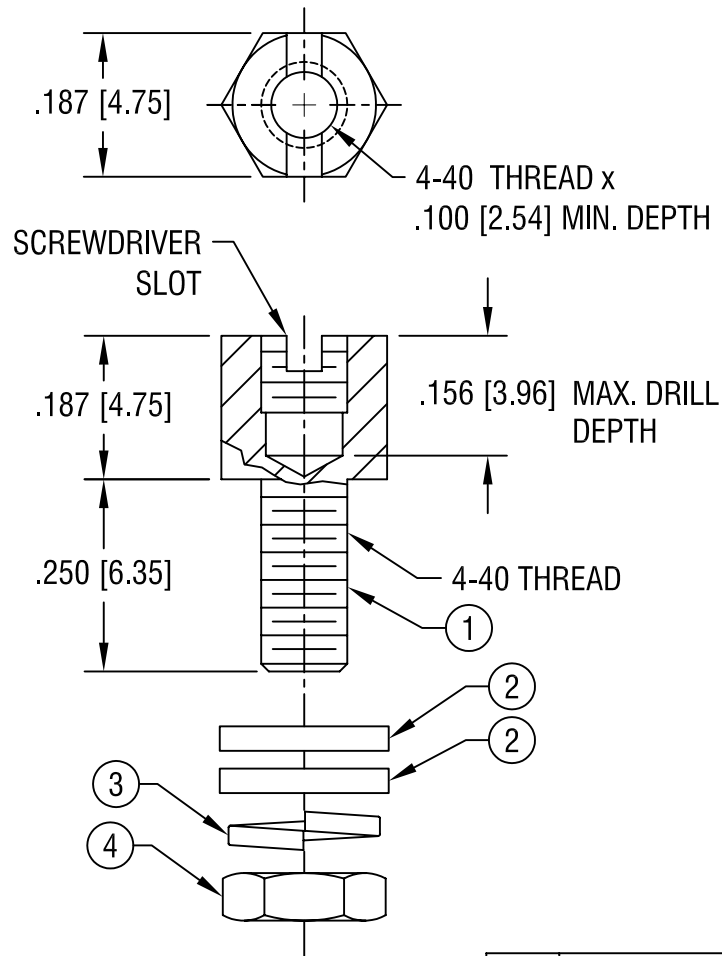

NO.	PART NO.	DESCRIPTION	QTY
1	7270	JACK SCREW	1
2	7230-1	FLAT WASHER	2
3	7230-2	LOCKWASHER	1
4	7230-3	NUT	1

NOTE:

1. FINISH: ZINC PLATE, TRIVALENT
AND YELLOW DIE.

KEYSTONE ELECTRONICS CORP.

ASTORIA, N.Y. 11105-2017

PART NAME

JACK SCREW W/ SLOT & HARDWARE

MATERIAL

STEEL

FINISH

AS NOTED

DRN BY

BOONE

DATE

3.10.06

APP'D

LN

SCALE

4X

TOLERANCES

INCH [MM]

DECIMAL $\pm .005$ [± 0.15]

ANGULAR $\pm 1^\circ$
UNLESS OTHERWISE SPECIFIED

CODE

C/M

DWG NO.

7290

DATE

DESCRIPTION

REV.