

THIS DRAWING IS UNPUBLISHED.

RELEASED FOR PUBLICATION

20

© COPYRIGHT 20 BY -

ALL RIGHTS RESERVED.

| LOC | DIST |
|-----|------|
| - | - |

| REVISIONS | | | | | |
|-----------|-----|--|-----------|-----|------|
| P | LTR | DESCRIPTION | DATE | DWN | APVD |
| | D | RELEASED AS PER ECR-11-012557 | 17JUN2011 | MZ | GT |
| | D1 | PARTS -2 -3 1-2 and 1-3 RELEASED FOR PRODUCTION | 27JUN2013 | KR | JC |
| | E | UPDATED DRAWING | 19DEC2014 | KR | MZ |

NOTES:

- 1 MATERIAL: POLYAMIDE GLASS FILLED COLOUR NATURAL
- 2 MATERIAL: POLYAMIDE GLASS FILLED COLOUR BLACK
- 3) PACKAGING: SEE TE PACKAGING SPECIFICATION 107-20294
- 4 TE LOGO
- 5 N CODE
- 6 L CODE
- 7 PE CODE
- 8 RATED VOLTAGE
- 9 WIRE SIZE & RATED CURRENT
- 10 AREA FOR AGENCY APPROVAL LOGO
- 11 IP CODE
- 12) SOCKET CAP P/N 293596-1 (SEE DRAWING 293596 FOR REFERENCE) HAS TO BE ASSEMBLED TO GUARANTEE IP40 DEGREE OF PROTECTION WHEN CONNECTOR HOUSING IS NOT MATTED WITH COUNTERPART
- 13 NOT YET RELEASED FOR PRODUCTION
- 14 DATA CODE

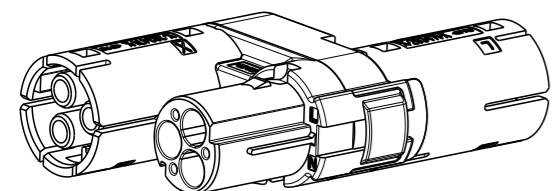
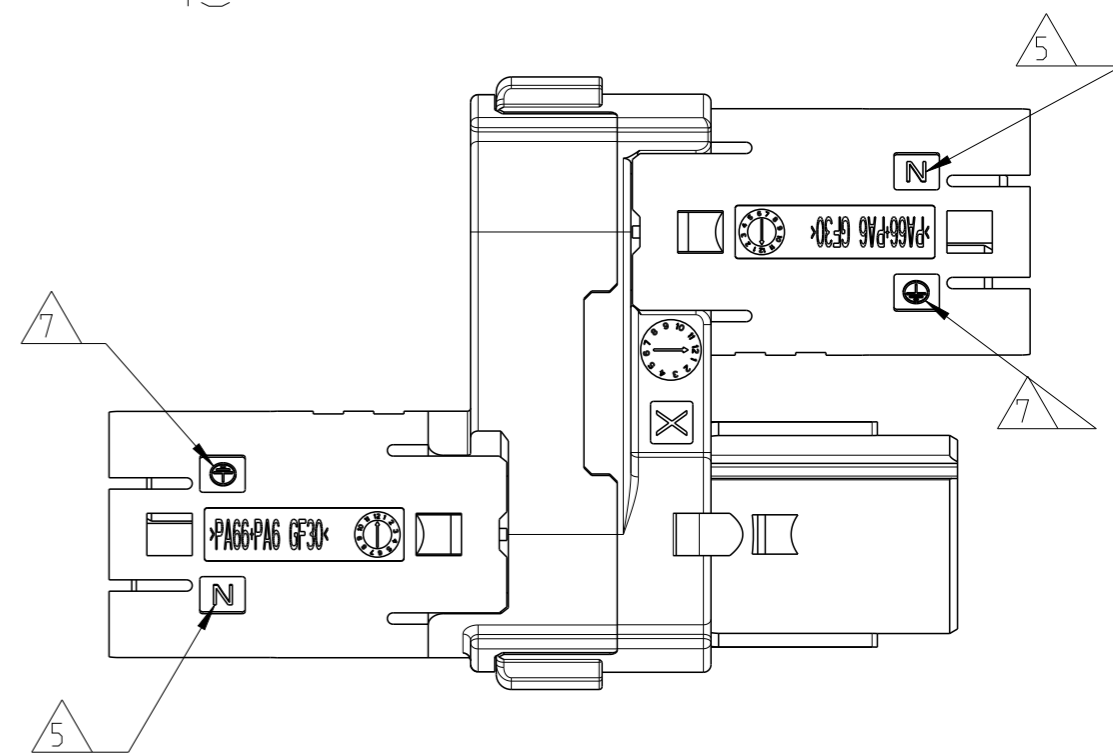
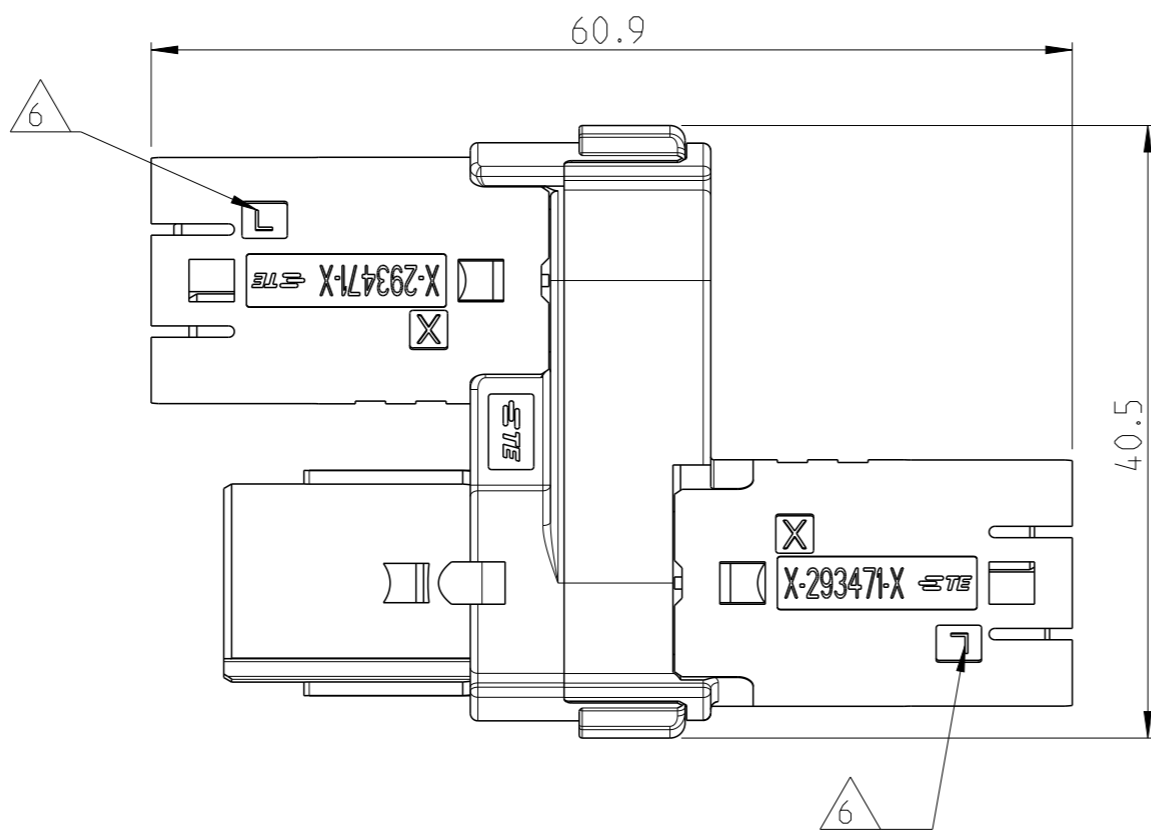
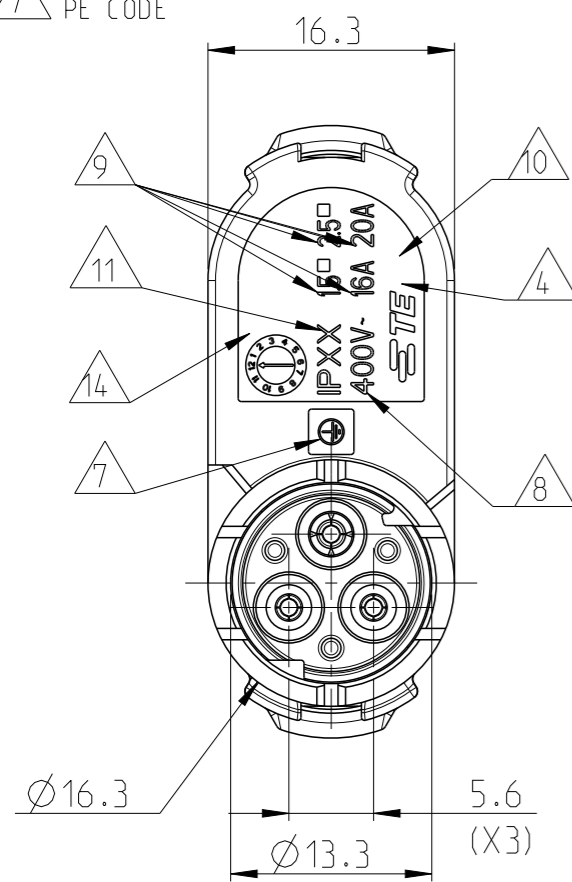
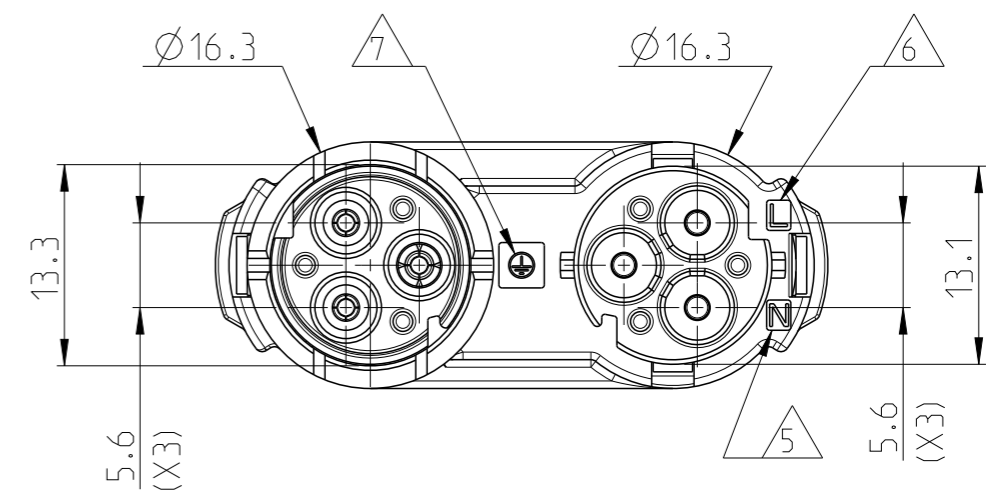

SCALE 1:1

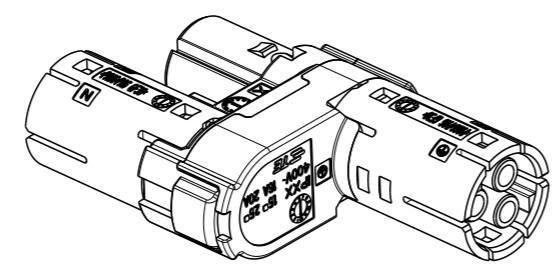

THIS DRAWING IS A CONTROLLED DOCUMENT.

| | |
|-------------|--|
| DIMENSIONS: | TOLERANCES UNLESS OTHERWISE SPECIFIED: |
| mm | |
| | 0 PLC ± |
| | 1 PLC ±0.3 |
| | 2 PLC ±0.20 |
| | 3 PLC ± |
| | 4 PLC ± |
| | ANGLES ±3° |
| MATERIAL | FINISH |
| - | - |

| | | |
|------------------|----------|-----------|
| DWN | M. ZUCCA | 06OCT2009 |
| CHK | U. AIME | 06OCT2009 |
| APVD | G. TURCO | 06OCT2009 |
| PRODUCT SPEC | - | - |
| APPLICATION SPEC | - | - |
| WEIGHT | - | - |

| | | | |
|--|-----------|------------|---------------|
| STE TE Connectivity | | | |
| NAME T-SPLITTER CONNECTOR* M-LINE 3 POLES UNSEALED VERSION | | | |
| SIZE | CAGE CODE | DRAWING NO | RESTRICTED TO |
| A3 | 00779 | C-293611 | - |

| | | | |
|------------------|-----------|--------------|-------|
| Customer Drawing | SCALE 2:1 | SHEET 1 OF 2 | REV E |
|------------------|-----------|--------------|-------|

THIS DRAWING IS UNPUBLISHED.

RELEASED FOR PUBLICATION

20









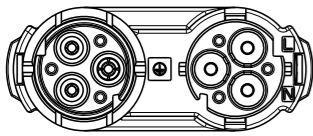
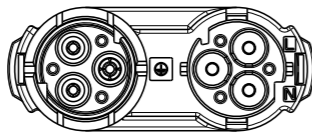
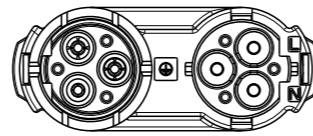
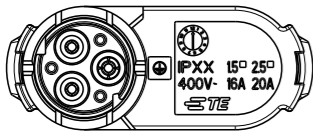
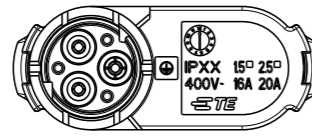
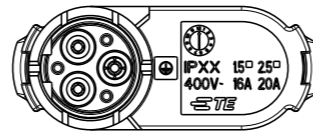
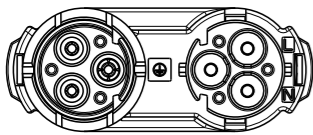
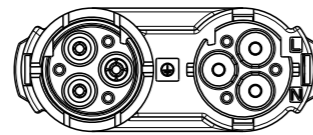
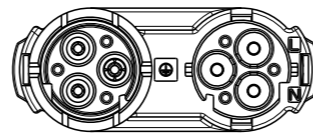
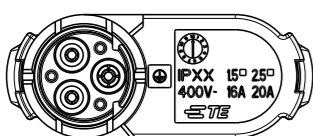
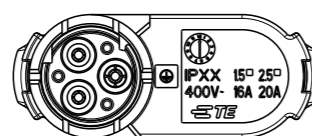
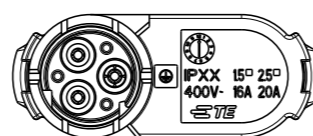

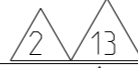
© COPYRIGHT 20 BY -

ALL RIGHTS RESERVED.

| LOC | DIST | REVISIONS | | | | | |
|-----|------|-----------|-----|-------------|------|-----|------|
| | | P | LTR | DESCRIPTION | DATE | DWN | APVD |
| - | - | - | - | SEE SHEET 1 | - | - | - |
| | | | | | | | |
| | | | | | | | |

POLARIZATION TYPES SCALE 1:1

| TYPE "A" | TYPE "B" | TYPE "C" |
|---|---|--|
|  |  |  |
|  |  |  |
| P/Ns: 293611-1, 1-293611-1 | P/Ns: 293611-2, 1-293611-2 | P/Ns: 293611-3, 1-293611-3 |
| TYPE "D" | TYPE "E" | TYPE "F" |
|  |  |  |
|  |  |  |
| P/Ns: 293611-4, 1-293611-4 | P/Ns: 293611-5, 1-293611-5 | P/Ns: 293611-6, 1-293611-6 |

| | | | | | | |
|---|----------|-------------|---------|------------------------------|------|-------------|
|  | UNSEALED | F | BLACK | T-SPLITTER CONNECTOR* M-LINE | D | 1-293611-6 |
|  | UNSEALED | E | BLACK | T-SPLITTER CONNECTOR* M-LINE | D | 1-293611-5 |
|  | UNSEALED | D | BLACK | T-SPLITTER CONNECTOR* M-LINE | D | 1-293611-4 |
|  | UNSEALED | C | BLACK | T-SPLITTER CONNECTOR* M-LINE | E | 1-293611-3 |
|  | UNSEALED | B | BLACK | T-SPLITTER CONNECTOR* M-LINE | E | 1-293611-2 |
|  | UNSEALED | A | BLACK | T-SPLITTER CONNECTOR* M-LINE | E | 1-293611-1 |
|  | UNSEALED | F | NATURAL | T-SPLITTER CONNECTOR* M-LINE | D | 293611-6 |
|  | UNSEALED | E | NATURAL | T-SPLITTER CONNECTOR* M-LINE | D | 293611-5 |
|  | UNSEALED | D | NATURAL | T-SPLITTER CONNECTOR* M-LINE | D | 293611-4 |
|  | UNSEALED | C | NATURAL | T-SPLITTER CONNECTOR* M-LINE | E | 293611-3 |
|  | UNSEALED | B | NATURAL | T-SPLITTER CONNECTOR* M-LINE | E | 293611-2 |
|  | UNSEALED | A | NATURAL | T-SPLITTER CONNECTOR* M-LINE | E | 293611-1 |
| NOTE | VERSION | POL. KEYING | COLOUR | DESCRIPTION | REV. | PART NUMBER |

THIS DRAWING IS A CONTROLLED DOCUMENT.

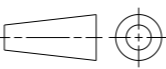
| DIMENSIONS: | TOLERANCES UNLESS OTHERWISE SPECIFIED: |
|---|--|
| mm | |
|  | 0 PLC ± |
| | 1 PLC ±0.3 |
| | 2 PLC ±0.20 |
| | 3 PLC ± |
| | 4 PLC ± |
| | ANGLES ±3° |
| MATERIAL - | FINISH - |

| | | |
|------------------|----------|-----------|
| DWN | M. ZUCCA | 06OCT2009 |
| CHK | U. AIME | 06OCT2009 |
| APVD | G. TURCO | 06OCT2009 |
| PRODUCT SPEC | - | - |
| APPLICATION SPEC | - | - |
| WEIGHT | - | - |

STE TE Connectivity

NAME: T-SPLITTER CONNECTOR* M-LINE 3 POLES UNSEALED VERSION

| | | | |
|------|-----------|------------|---------------|
| SIZE | CAGE CODE | DRAWING NO | RESTRICTED TO |
| A3 | 00779 | ©=293611 | - |

Customer Drawing SCALE 1:1 SHEET 2 OF 2 REV E