

# ISL85403EVAL2Z Evaluation Board User Guide

## Description

The ISL85403EVAL2Z board allows quick evaluation of the ISL85403 in the noninverting buck-boost configuration. It is a cost effective solution for the low-power, wide input voltage range point-of-load application where both stepping up and stepping down voltage capabilities are required.

## Specifications

The design specifications of the ISL85403EVAL2Z are shown in [Table 1](#).

**TABLE 1. SPECIFICATIONS**

| PARAMETERS                     | VALUES           |
|--------------------------------|------------------|
| Input Voltage ( $V_{IN}$ )     | 8V to 40V        |
| Output Voltage ( $V_{OUT}$ )   | 12.0V            |
| Max. Output Current (IOUT_MAX) | 1A               |
| Switching Frequency            | 500kHz           |
| Output Ripple                  | 360mV at 1A Load |

## Key Features

- Small, compact design
- $V_{IN}$  range of 8V to 40V
- Convenient power connection

## References

[ISL85403](#) Datasheet

## Ordering Information

| PART NUMBER    | DESCRIPTION  |
|----------------|--|
| ISL85403EVAL2Z | ISL85403 Evaluation Board, buck-boost configuration 12V output |

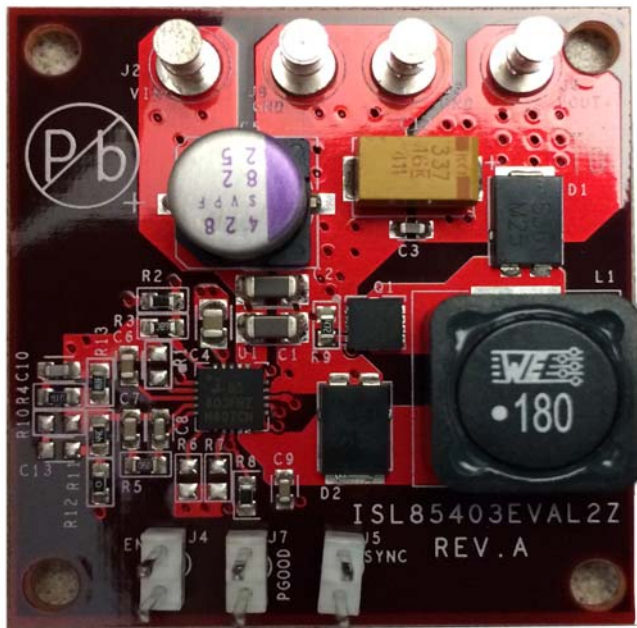

**FIGURE 1. TOP VIEW**



**FIGURE 2. BOTTOM VIEW**

## Functional Description

The ISL85403 is a flexible switching regulator with an integrated 127mΩ high-side MOSFET. It can be used as a synchronous buck converter, a 2-stage boost-buck converter, or a noninverting buck-boost converter.

The ISL85403EVAL2Z board demonstrates the operations of the ISL85403 in the noninverting buck-boost configuration. The ISL85403EVAL2Z board is shown in [Figures 1](#) and [2](#).

The schematic is shown on [page 4](#), bill of materials on [page 4](#), and PCB layers for reference start on [page 7](#). [Figures 4](#) through [15](#) show performance data taken from the evaluation board.

## Operating Range

The board input voltage range is 8V to 40V. The output voltage is set to 12V and can be changed by voltage feedback resistors R<sub>11</sub> and R<sub>13</sub>, as shown in [Equation 1](#):

$$R_{13} = R_{11} \cdot \frac{V_{ref}}{V_{OUT} - V_{ref}} \quad (EQ. 1)$$

Note: In order to change to a higher output voltage, the output capacitors have to be changed for the higher voltage rating.

The board is set to a default frequency of 500kHz (FS pin/R<sub>1</sub> is open). The switching frequency can be programmed to other values by a resistor at R<sub>1</sub>. Refer to the [ISL85403](#) datasheet for the resistor value and the switching frequency. The switching frequency can also be synchronized to external clock by connecting the external clock to the SYNC terminal (J5).

## Inductor Current

In the noninverting buck-boost configuration, the inductor current (I<sub>L</sub>) can be expressed as:

$$I_L = I_{OUT} \cdot \frac{V_{OUT} + V_{IN}}{V_{IN}} \quad (EQ. 2)$$

The maximum inductor current happens at the condition of the minimum input voltage and the maximum output current. The inductor used in this noninverting buck-boost configuration should have saturation current higher than the maximum inductor current.

$$I_{L, sat} > I_{OUT, max} \cdot \frac{V_{OUT} + V_{IN, min}}{V_{IN, min}} \quad (EQ. 3)$$

## PCB Layout Guidelines

1. Place the input ceramic capacitors as closely as possible to the IC VIN pin and power ground connecting to the power diode. Keep this loop (input ceramic capacitor, IC VIN pin and diode) as small as possible to minimize the voltage spikes induced by the trace parasitic inductance. A bulk capacitor, C5 (as shown in the [“ISL85403EVAL2Z Circuit Schematic”](#) on [page 3](#)), is included to support long wire connections from power supplies to the evaluation board.
2. Keep the phase node copper area small but large enough to handle the load current.
3. On the output side, place the output ceramic capacitors as closely as possible to the cathode of the power diode and the

source of the MOSFET. Keep this loop (output ceramic capacitor, MOSFET and diode) as small as possible to minimize the voltage spikes induced by the trace parasitic inductance.

4. Place the output ceramic and aluminum capacitors close to the power stage components as well.
5. Place vias (at least 9) in the bottom pad of the IC. The bottom pad should be placed in ground copper plane with an area as large as possible in multiple layers to effectively reduce the thermal impedance.
6. Place the 4.7μF ceramic decoupling capacitor (C4 as shown in the [“ISL85403EVAL2Z Circuit Schematic”](#) on [page 3](#)) as close as possible to the IC's VCC pin. Put multiple vias close to the ground pad of this capacitor.
7. Keep the bootstrap capacitor close to the IC.
8. Keep the LGATE drive trace as short as possible and try to avoid using vias in the LGATE drive path to achieve the lowest impedance.
9. Place the output voltage sense trace close to the place that is to be strictly regulated.
10. Place all the peripheral control components close to the IC.

## Quick Test Setup

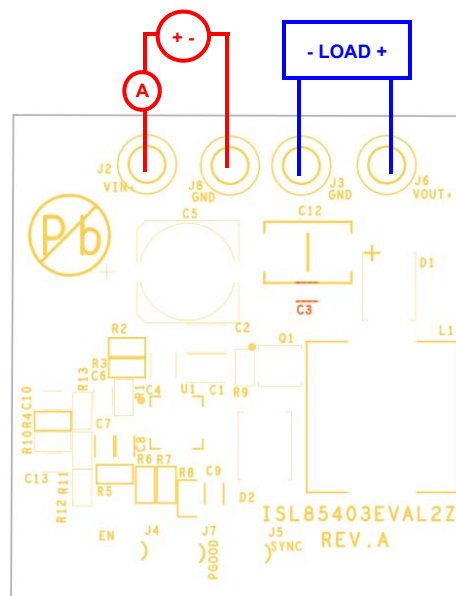

FIGURE 3. ISL85403EVAL2Z BOARD SETUP

1. Connect the power supply to the input terminals VIN (J2) and GND (J8). Connect the load terminals to the output VOUT (J6) and GND (J3). Make sure the setup is correct prior to applying any power or load to the board.
2. Adjust the power supply to 8V to 40V and turn it on.
3. Verify the output voltage is 12V and use oscilloscope to monitor the phase node waveforms.



## User Guide 010

### Bill of Materials

| REF DES                    | PART NUMBER        | QTY | DESCRIPTION  | MANUFACTURER     |
|----------------------------|--------------------|-----|--|------------------|
| C5                         | HHXA630ARA330MHA0G | 1   | Aluminum Electrolytic Capacitor, SMD, 8x10, 33μF, 63V, 20%, 40mΩ, ROHS | UNITED CHEMI-CON |
| C6                         | VARIOUS            | 1   | CAP, SMD, 0603, 0.1μF, 50V, 10%, X7R, ROHS                             | VARIOUS          |
| C3                         | VARIOUS            | 1   | CAP, SMD, 0603, 1μF, 16V, 10%, X5R, ROHS                               | VARIOUS          |
| C9                         | VARIOUS            | 1   | CAP, SMD, 0603, 0.22μF, 25V, 10%, X7R, ROHS                            | VARIOUS          |
| C10                        | VARIOUS            | 1   | CAP, SMD, 0603, 470pF, 50V, 5%, NPO, ROHS                              | VARIOUS          |
| C7                         | VARIOUS            | 1   | CAP, SMD, 0603, 4700pF, 50V, 10%, X7R, ROHS                            | VARIOUS          |
| C8                         | VARIOUS            | 1   | CAP, SMD, 0603, 68pF, 50V, 10%, NPO, ROHS                              | VARIOUS          |
| C1, C2                     | VARIOUS            | 2   | CAP, SMD, 1206, 4.7μF, 50V, 10%, X5R, ROHS                             | VARIOUS          |
| C12                        | T521X337M016ATE025 | 1   | CAP-TANT, LOW-ESR, SMD, 7.3x4.3x4, 330μF, 16V, 20%, 25mΩ, ROHS         | KEMET            |
| D1, D2                     | SS6P3LHM3/86A      | 2   | DIODE-SCHOTTKY RECTIFIER, SMD, SMPC, 60V, 3A, ROHS                     | VISHAY           |
| L1                         | 744770118          | 1   | COIL-PWR INDUCTOR, SMD, 12mm, 18μH, 20%, 4.2A, 0.032Ω, ROHS            | WURTH            |
| U1                         | ISL85403IRZ        | 1   | IC-SWITCHING REGULATOR, 20P, QFN, 4X4, ROHS                            | INTERSIL         |
| Q1                         | BSZ100N06LS3G      | 1   | TRANSIST-MOS, N-CHANNEL, 8P, PG-TSDSON-8, 60V, 20A, ROHS               | INFINEON         |
| R2                         | VARIOUS            | 1   | RES, SMD, 0603, 348k, 1/10W, 1%, TF, ROHS                              | VARIOUS          |
| R3                         | VARIOUS            | 1   | RES, SMD, 0603, 49.9k, 1/10W, 1%, TF, ROHS                             | VARIOUS          |
| R4                         | VARIOUS            | 1   | RES, SMD, 0603, 100Ω, 1/10W, 1%, TF, ROHS                              | VARIOUS          |
| R5                         | VARIOUS            | 1   | RES, SMD, 0603, 113k, 1/10W, 1%, TF, ROHS                              | VARIOUS          |
| R8                         | VARIOUS            | 1   | RES, SMD, 0603, 200k, 1/10W, 1%, TF, ROHS                              | VARIOUS          |
| R9                         | VARIOUS            | 1   | RES, SMD, 0603, 4.7k, 1/10W, 1%, TF, ROHS                              | VARIOUS          |
| R11                        | VARIOUS            | 1   | RES, SMD, 0603, 28k, 1/10W, 1%, TF, ROHS                               | VARIOUS          |
| R12                        | VARIOUS            | 1   | RES, SMD, 0603, 0Ω, 1/10W, 1%, TF, ROHS                                | VARIOUS          |
| R13                        | VARIOUS            | 1   | RES, SMD, 0603, 2k, 1/10W, 1%, TF, ROHS                                | VARIOUS          |
| R1, R6,<br>R7, R10,<br>C13 | N/A                | 0   | Do not populate  | N/A              |

Intersil Corporation reserves the right to make changes in circuit design, software and/or specifications at any time without notice. Accordingly, the reader is cautioned to verify that the Application Note or Technical Brief is current before proceeding.

For information regarding Intersil Corporation and its products, see [www.intersil.com](http://www.intersil.com)

## Typical Performance Curves

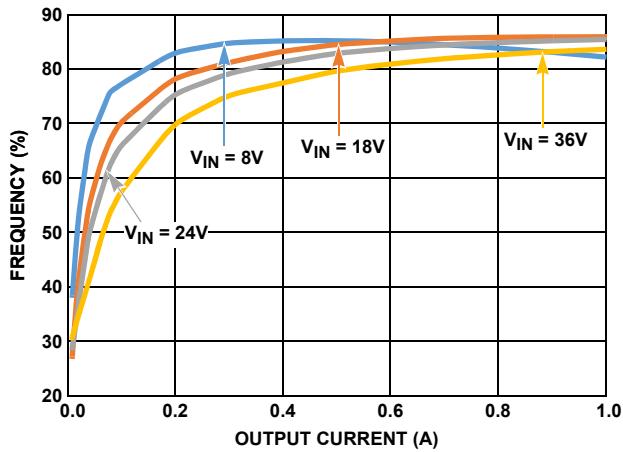

FIGURE 4. EFFICIENCY vs LOAD

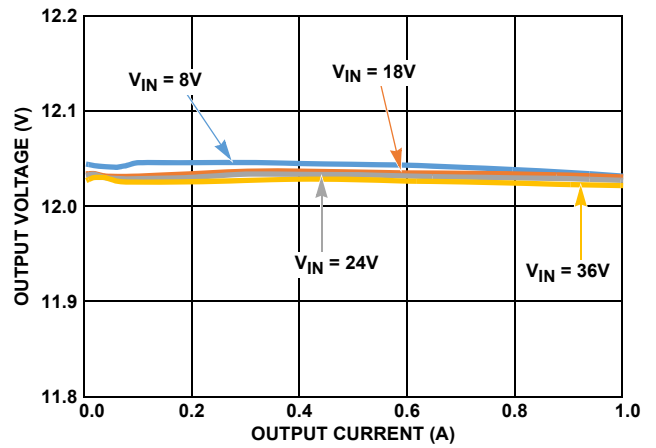

FIGURE 5. LOAD REGULATION

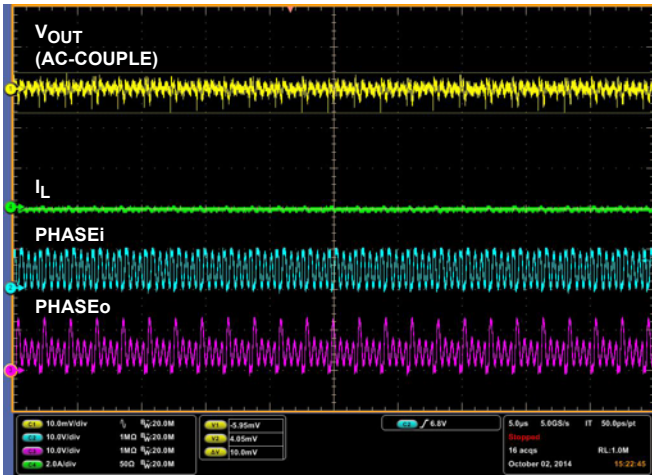

FIGURE 6. OUTPUT RIPPLE AT 0A LOAD ( $V_{IN} = 8V$ )



FIGURE 7. OUTPUT RIPPLE AT 1A LOAD ( $V_{IN} = 8V$ )

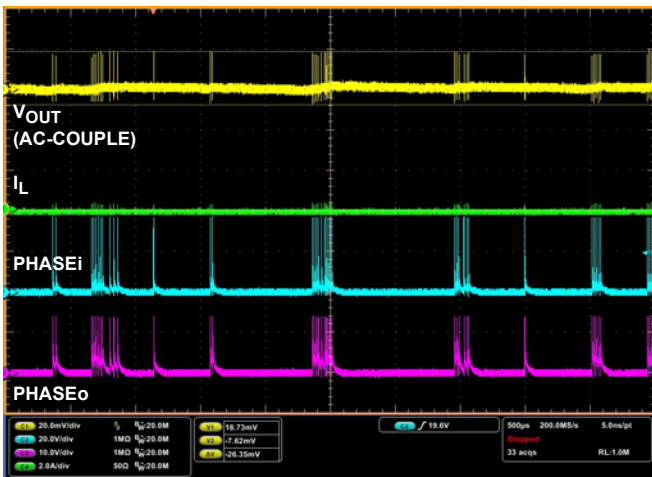

FIGURE 8. OUTPUT RIPPLE AT 0A LOAD ( $V_{IN} = 36V$ )

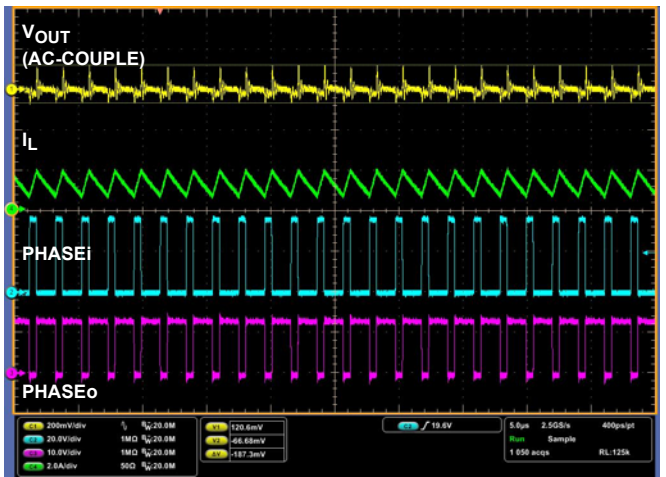

FIGURE 9. OUTPUT RIPPLE AT 1A LOAD ( $V_{IN} = 36V$ )

Typical Performance Curves (Continued)

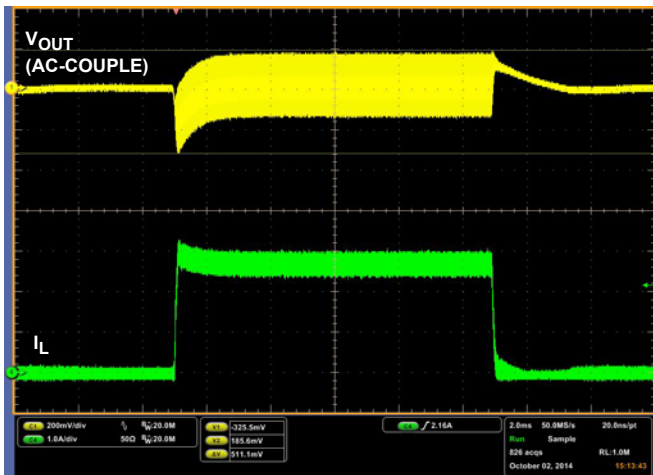

FIGURE 10. LOAD TRANSIENT RESPONSE 0A->1A,  $V_{IN} = 8V$



FIGURE 11. LOAD TRANSIENT RESPONSE 0A->1A,  $V_{IN} = 36V$

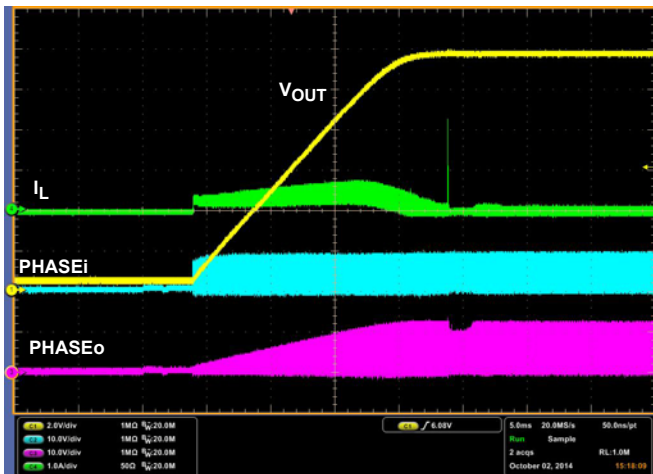

FIGURE 12. SOFT-START AT 0A LOAD ( $V_{IN} = 8V$ )

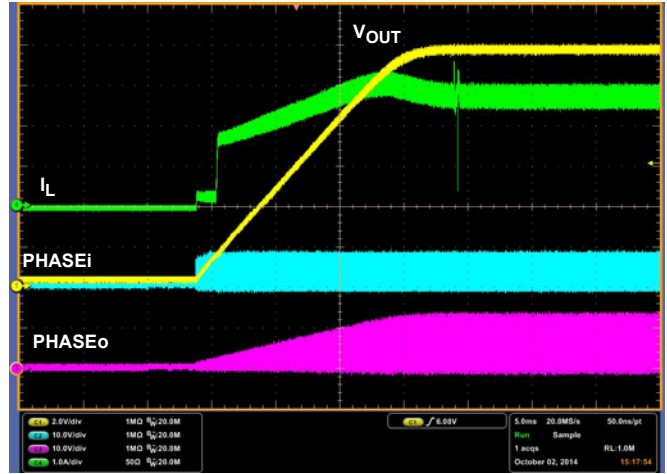

FIGURE 13. SOFT-START AT 1A LOAD ( $V_{IN} = 8V$ )

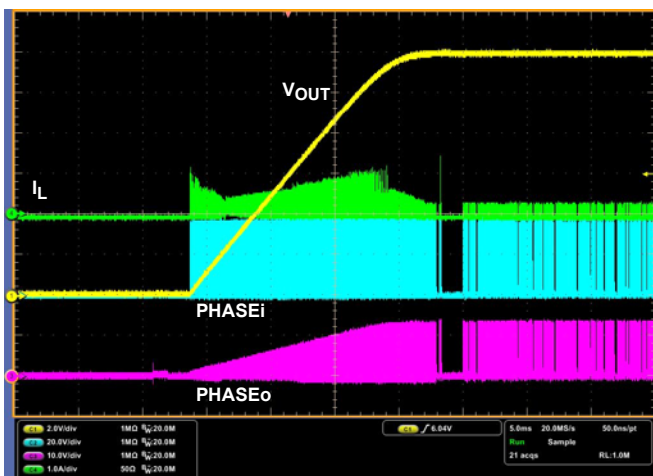

FIGURE 14. SOFT-START AT 0A LOAD ( $V_{IN} = 36V$ )

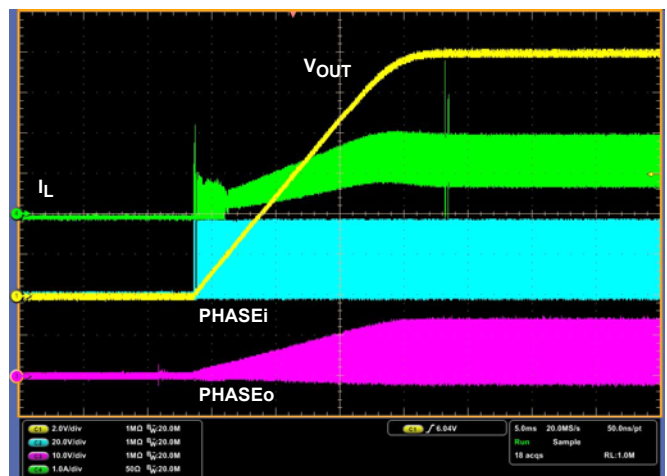

FIGURE 15. SOFT-START AT 1A LOAD ( $V_{IN} = 36V$ )

## Board Layout

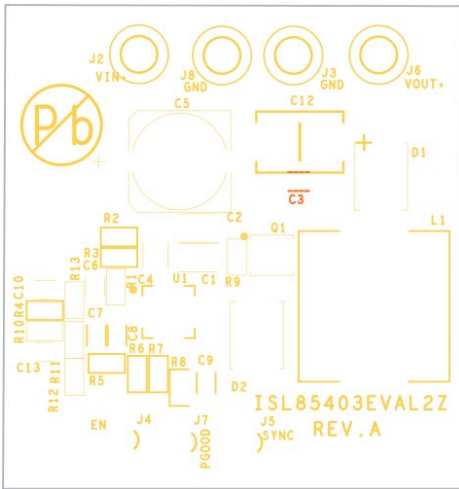

FIGURE 16. SILKSCREEN TOP

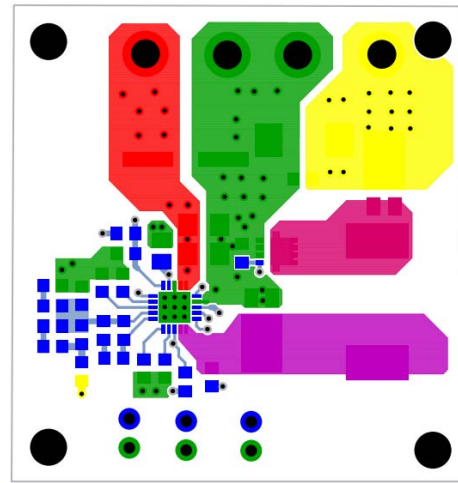

FIGURE 17. TOP LAYER

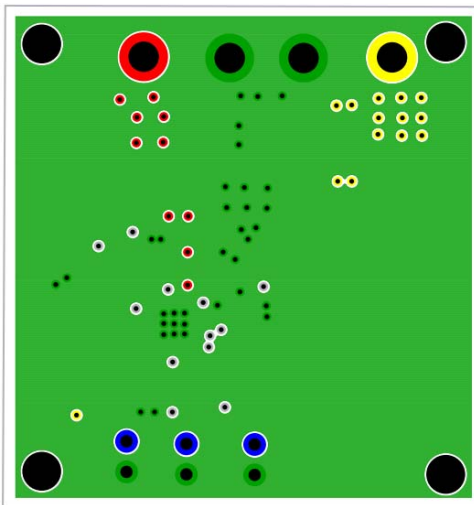

FIGURE 18. LAYER 2

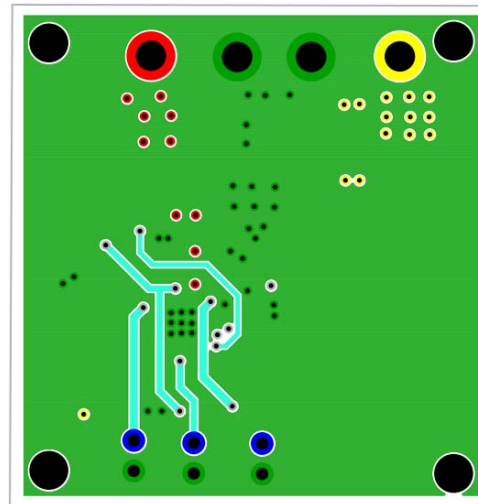

FIGURE 19. LAYER 3

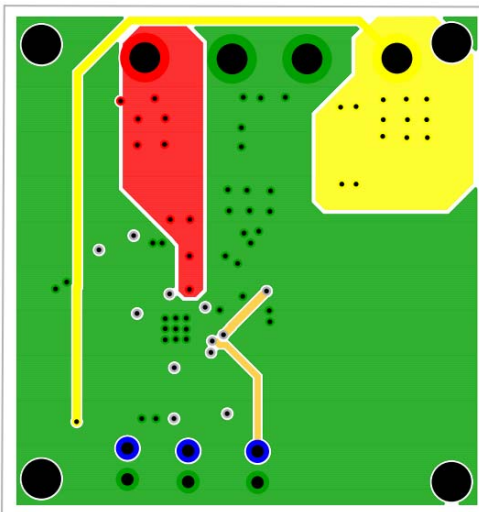

FIGURE 20. BOTTOM LAYER



FIGURE 21. SILKSCREEN BOTTOM