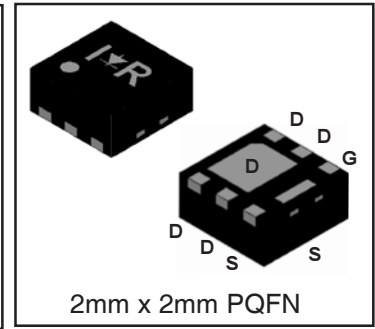
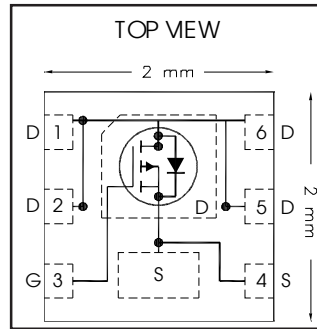


V_{DS}	-30	V
$V_{GS\ max}$	±20	V
$R_{DS(on)\ max}$ (@ $V_{GS} = -10V$)	37	mΩ
Q_g (typical)	13	nC
I_D (@ $T_C = 25^\circ C$)	-8.5 ②	A



Applications

- Charge and Discharge Switch for Battery Application
- System/load switch

Features and Benefits

Features

Low $R_{DS(on)}$ ($\leq 37m\Omega$)
Low Thermal Resistance to PCB ($\leq 13^\circ C/W$)
Low Profile ($\leq 1.0\ mm$)
Compatible with Existing Surface Mount Techniques
RoHS Compliant Containing no Lead, no Bromide and no Halogen
MSL1, Industrial Qualification

results in

Benefits

Lower Conduction Losses
Enable better thermal dissipation
Increased Power Density
Easier Manufacturing
Environmentally Friendlier
Increased Reliability

Orderable part number	Package Type	Standard Pack		Note
		Form	Quantity	
IRFHS9301TRPBF	PQFN 2mm x 2mm	Tape and Reel	4000	
IRFHS9301TR2PBF	PQFN 2mm x 2mm	Tape and Reel	400	EOL notice # 259

Absolute Maximum Ratings

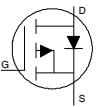
	Parameter	Max.	Units
V_{DS}	Drain-to-Source Voltage	-30	V
V_{GS}	Gate-to-Source Voltage	± 20	
$I_D @ T_A = 25^\circ C$	Continuous Drain Current, $V_{GS} @ -10V$	-6.0	A
$I_D @ T_A = 70^\circ C$	Continuous Drain Current, $V_{GS} @ -10V$	-4.8	
$I_D @ T_C = 25^\circ C$	Continuous Drain Current, $V_{GS} @ -10V$	-13②	
$I_D @ T_C = 70^\circ C$	Continuous Drain Current, $V_{GS} @ -10V$	-10②	
$I_D @ T_C = 25^\circ C$	Continuous Drain Current, $V_{GS} @ 10V$ (Package Limited)	-8.5②	
I_{DM}	Pulsed Drain Current ①	-52	
$P_D @ T_A = 25^\circ C$	Power Dissipation ④	2.1	W
$P_D @ T_A = 70^\circ C$	Power Dissipation ④	1.3	
	Linear Derating Factor	0.02	W/°C
T_J	Operating Junction and	-55 to + 150	°C
T_{STG}	Storage Temperature Range		

Notes ① through ⑤ are on page 2

Static @ T_J = 25°C (unless otherwise specified)

	Parameter	Min.	Typ.	Max.	Units	Conditions
BV _{DSS}	Drain-to-Source Breakdown Voltage	-30	—	—	V	V _{GS} = 0V, I _D = -250μA
ΔBV _{DSS} /ΔT _J	Breakdown Voltage Temp. Coefficient	—	0.02	—	V/°C	Reference to 25°C, I _D = -1mA
R _{DS(on)}	Static Drain-to-Source On-Resistance	—	30	37	mΩ	V _{GS} = -10V, I _D = -7.8A ③
		—	52	65		V _{GS} = -4.5V, I _D = -6.2A ③
V _{GS(th)}	Gate Threshold Voltage	-1.3	-1.8	-2.4	V	V _{DS} = V _{GS} , I _D = -25μA
ΔV _{GS(th)}	Gate Threshold Voltage Coefficient	—	-4.8	—	mV/°C	
I _{DSS}	Drain-to-Source Leakage Current	—	—	-1.0	μA	V _{DS} = -24V, V _{GS} = 0V
		—	—	-150		V _{DS} = -24V, V _{GS} = 0V, T _J = 125°C
I _{GSS}	Gate-to-Source Forward Leakage	—	—	-100	nA	V _{GS} = -20V
	Gate-to-Source Reverse Leakage	—	—	100		V _{GS} = 20V
g _{fs}	Forward Transconductance	9.3	—	—	S	V _{DS} = -10V, I _D = -7.8A
Q _g	Total Gate Charge	—	6.9	—	nC	V _{DS} = -15V, V _{GS} = -4.5V, I _D = -7.8A
Q _g	Total Gate Charge	—	13	—	nC	V _{GS} = -10V
Q _{gs}	Gate-to-Source Charge	—	2.1	—		V _{DS} = -15V
Q _{gd}	Gate-to-Drain Charge	—	3.9	—		I _D = -7.8A
R _G	Gate Resistance	—	17	—	Ω	
t _{d(on)}	Turn-On Delay Time	—	12	—	ns	V _{DD} = -15V, V _{GS} = -4.5V ③
t _r	Rise Time	—	80	—		I _D = -7.8A
t _{d(off)}	Turn-Off Delay Time	—	13	—		R _G = 2.0Ω
t _f	Fall Time	—	25	—		See Figs. 19a & 19b
C _{iss}	Input Capacitance	—	580	—	pF	V _{GS} = 0V
C _{oss}	Output Capacitance	—	125	—		V _{DS} = -25V
C _{rss}	Reverse Transfer Capacitance	—	79	—		f = 1.0KHz

Diode Characteristics

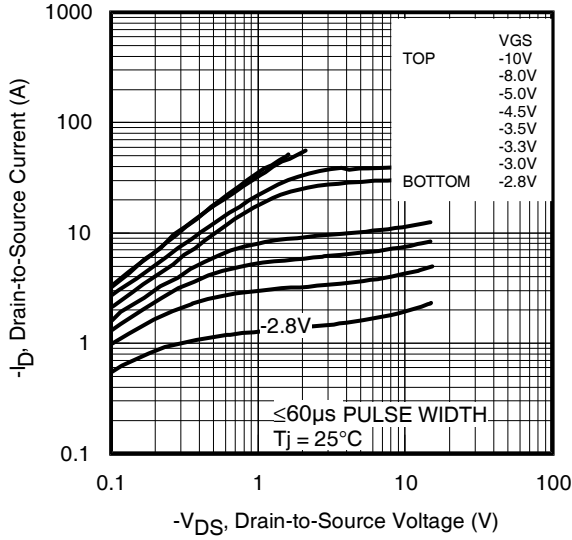
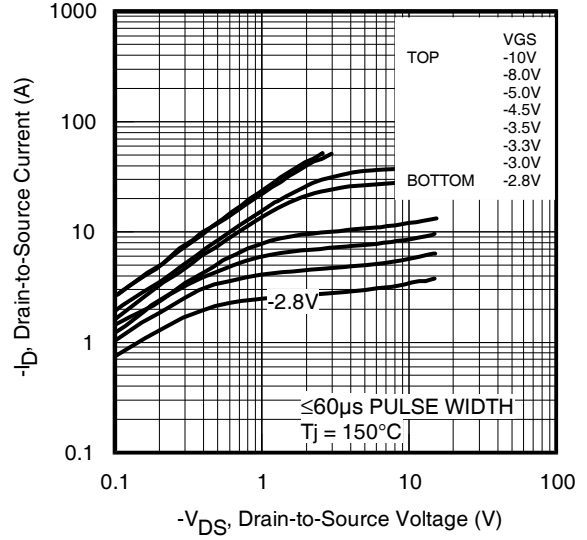
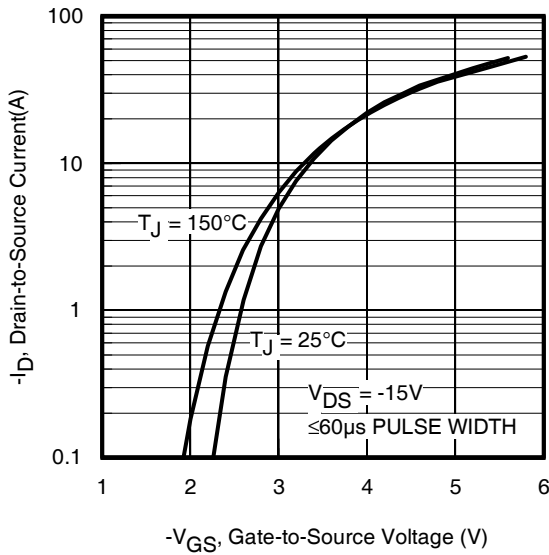
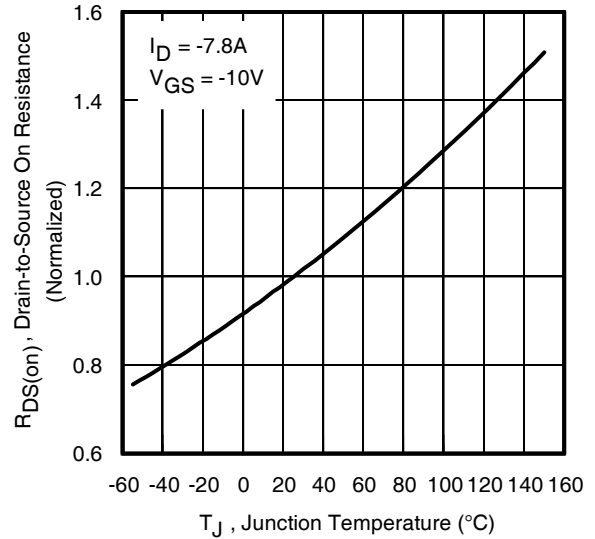
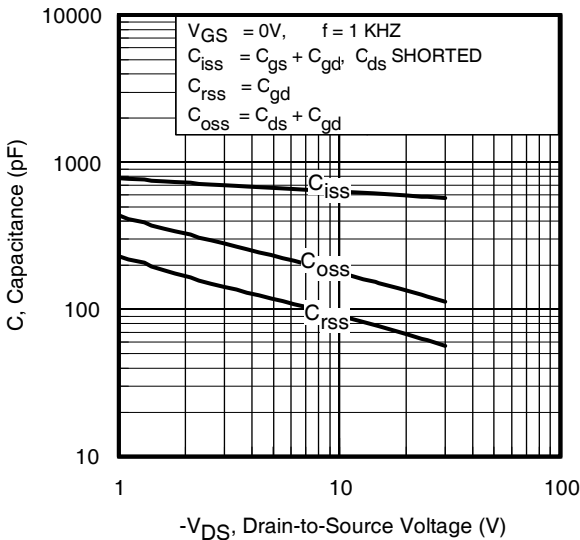
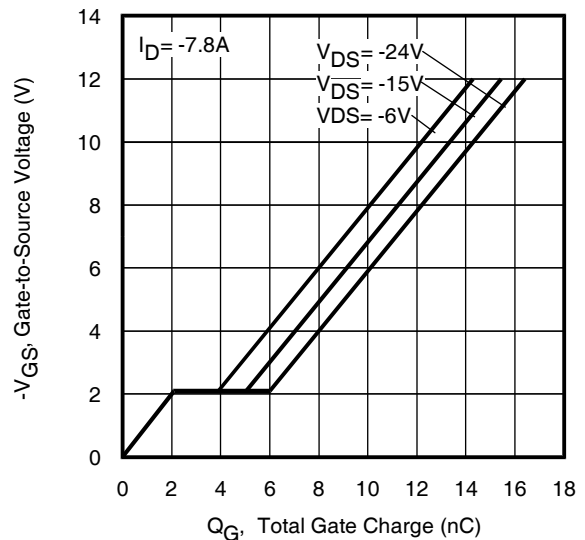
	Parameter	Min.	Typ.	Max.	Units	Conditions
I _S	Continuous Source Current (Body Diode)	—	—	-8.5②	A	MOSFET symbol showing the integral reverse p-n junction diode. 
I _{SM}	Pulsed Source Current (Body Diode) ①	—	—	-52		
V _{SD}	Diode Forward Voltage	—	—	-1.2	V	T _J = 25°C, I _S = -7.8A, V _{GS} = 0V ③
t _{rr}	Reverse Recovery Time	—	30	45	ns	T _J = 25°C, I _F = -7.8A, V _{DD} = -15V
Q _{rr}	Reverse Recovery Charge	—	110	170	nC	di/dt = 280/μs ③

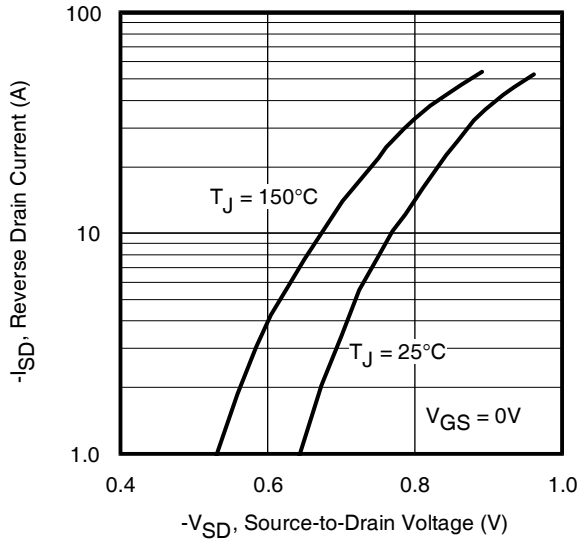
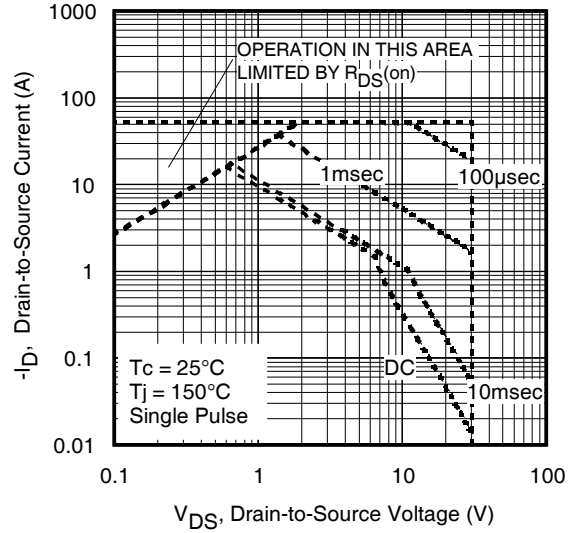
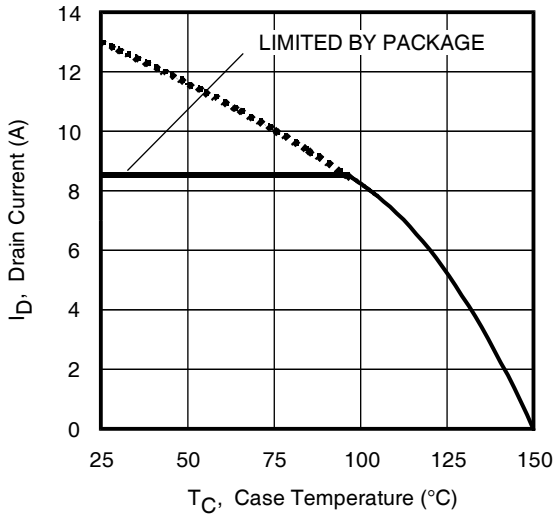
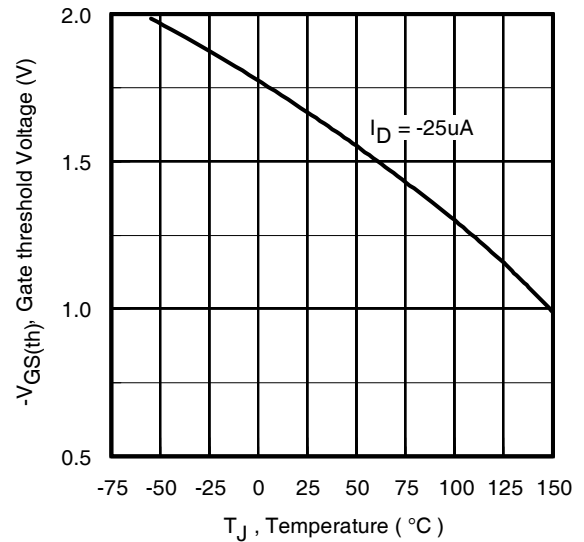
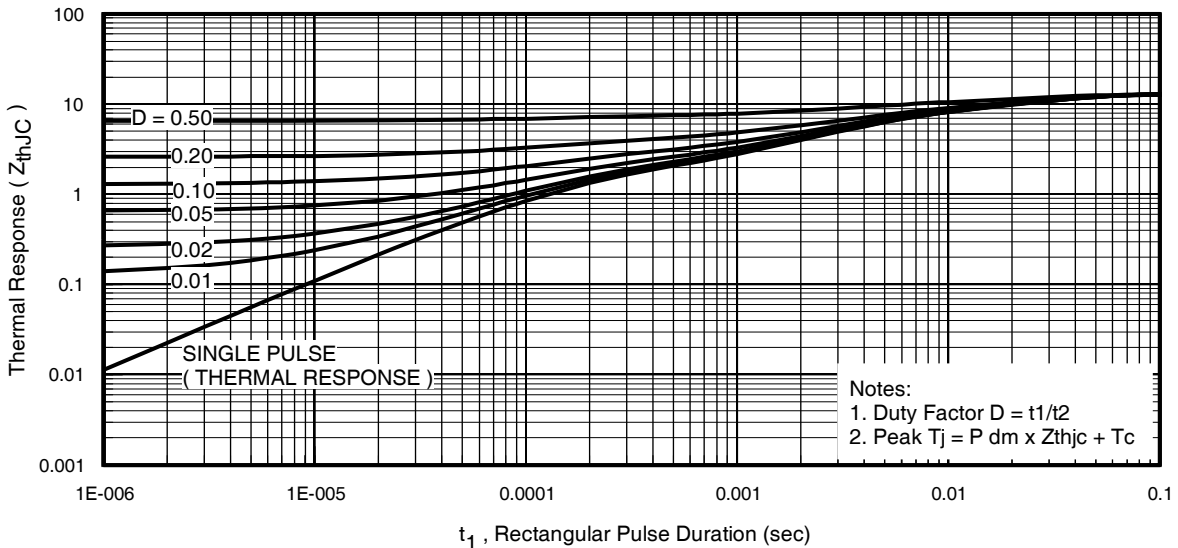
Thermal Resistance

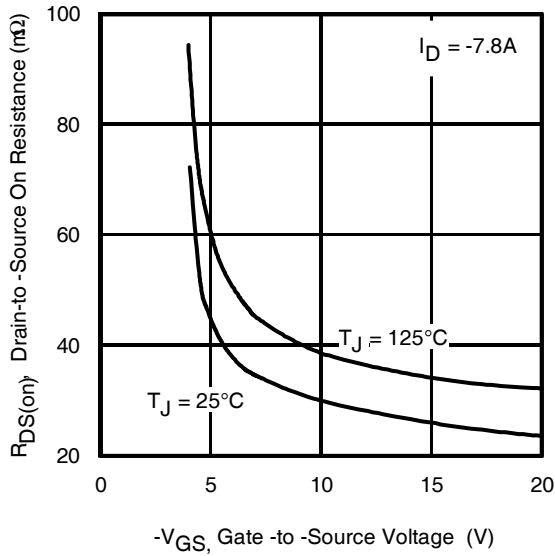
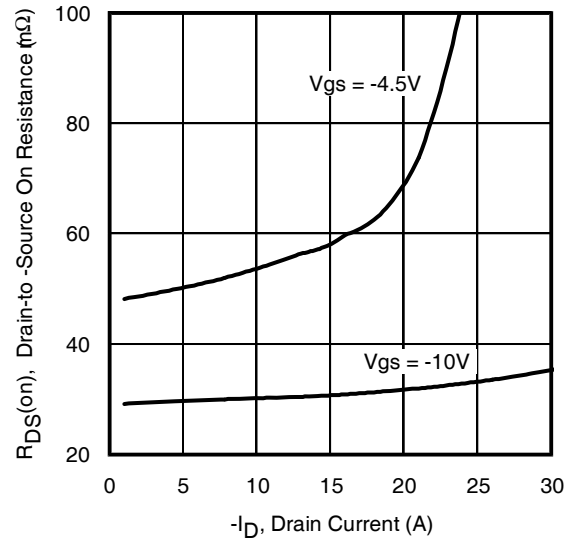
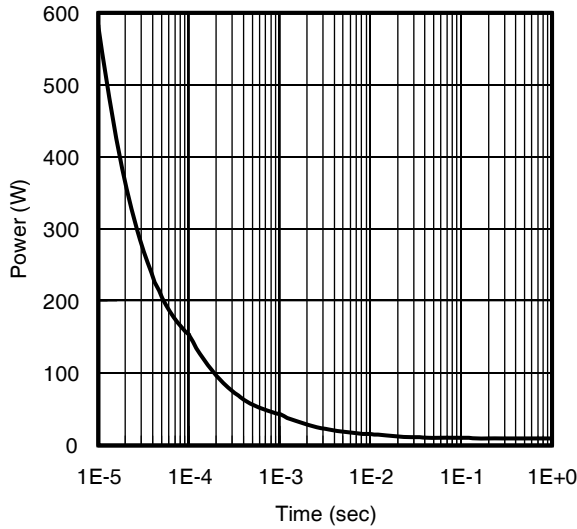
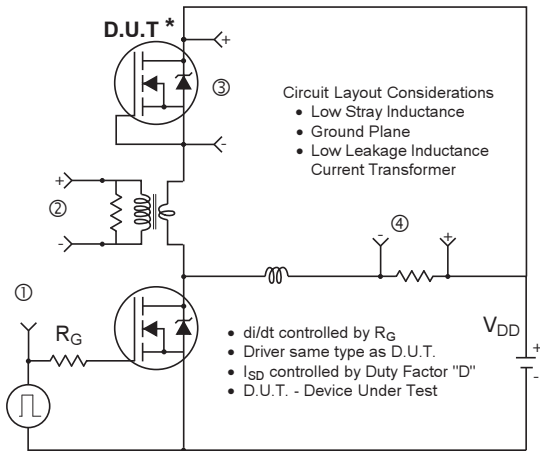
	Parameter	Typ.	Max.	Units
R _{θJC} (Bottom)	Junction-to-Case ⑤	—	13	°C/W
R _{θJC} (Top)	Junction-to-Case ⑤	—	90	
R _{θJA}	Junction-to-Ambient ④	—	60	
R _{θJA}	Junction-to-Ambient (t<10s) ④	—	42	

Notes:

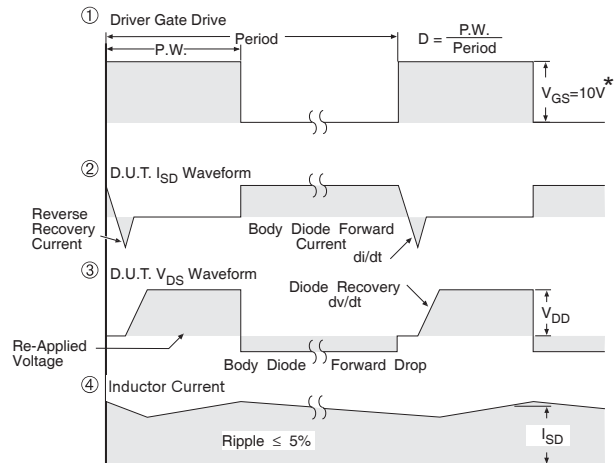
- ① Repetitive rating; pulse width limited by max. junction temperature.
- ② Current limited by package.
- ③ Pulse width ≤ 400μs; duty cycle ≤ 2%.
- ④ When mounted on 1 inch square copper board.
- ⑤ R_θ is measured at T_J of approximately 90°C.

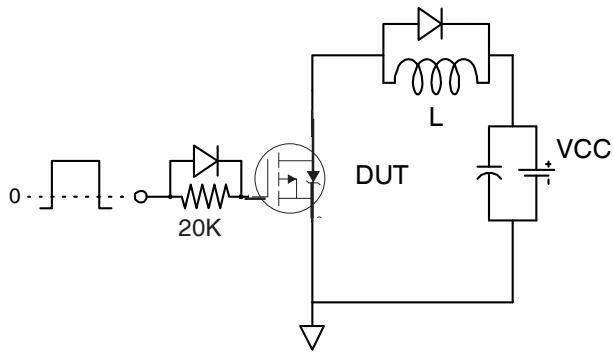
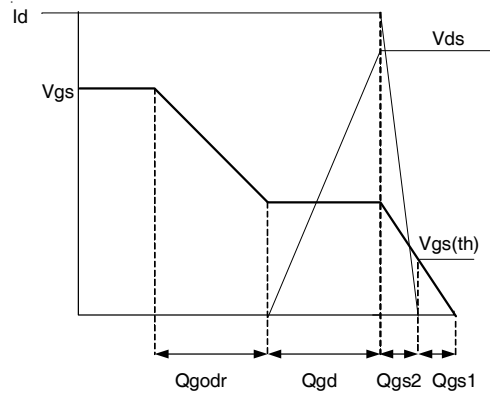
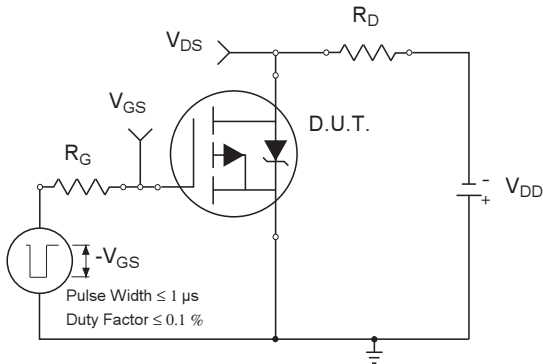
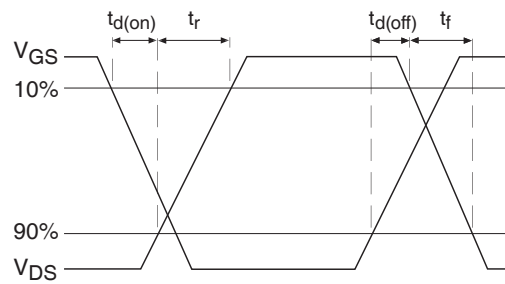

Fig 1. Typical Output Characteristics

Fig 2. Typical Output Characteristics

Fig 3. Typical Transfer Characteristics

Fig 4. Normalized On-Resistance vs. Temperature

Fig 5. Typical Capacitance vs. Drain-to-Source Voltage

Fig 6. Typical Gate Charge vs. Gate-to-Source Voltage


Fig 7. Typical Source-Drain Diode Forward Voltage

Fig 8. Maximum Safe Operating Area

Fig 9. Maximum Drain Current vs. Case Temperature

Fig 10. Threshold Voltage vs. Temperature

Fig 11. Maximum Effective Transient Thermal Impedance, Junction-to-Case

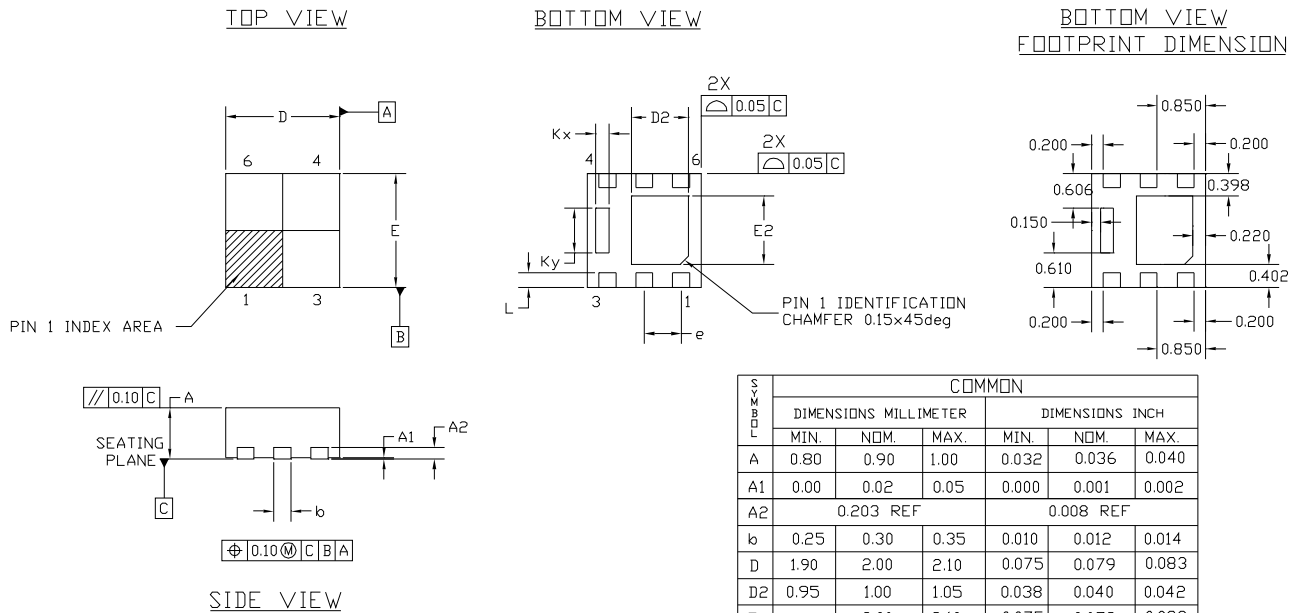

Fig 12. On-Resistance vs. Gate Voltage

Fig 13. Typical On-Resistance vs. Drain Current

Fig 14. Typical Power vs. Time


* Reverse Polarity of D.U.T for P-Channel


Fig 15. Diode Reverse Recovery Test Circuit for P-Channel HEXFET® Power MOSFETs


Fig 16a. Gate Charge Test Circuit

Fig 16b. Gate Charge Waveform

Fig 17a. Switching Time Test Circuit

Fig 17b. Switching Time Waveforms

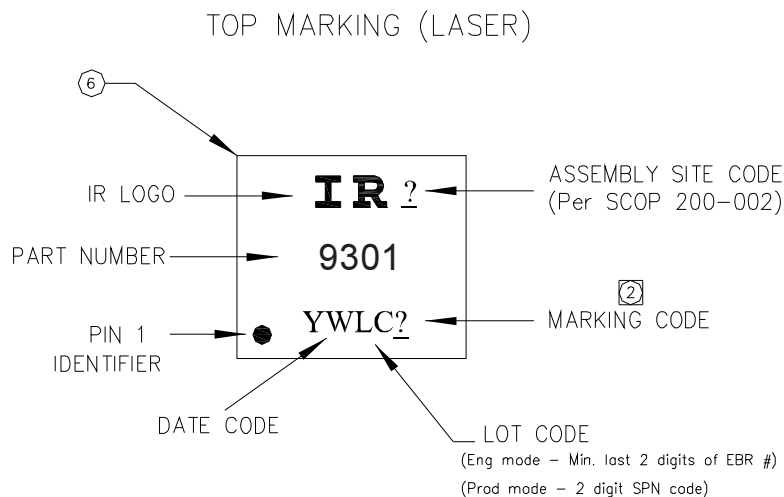
PQFN Package Details



NOTES :

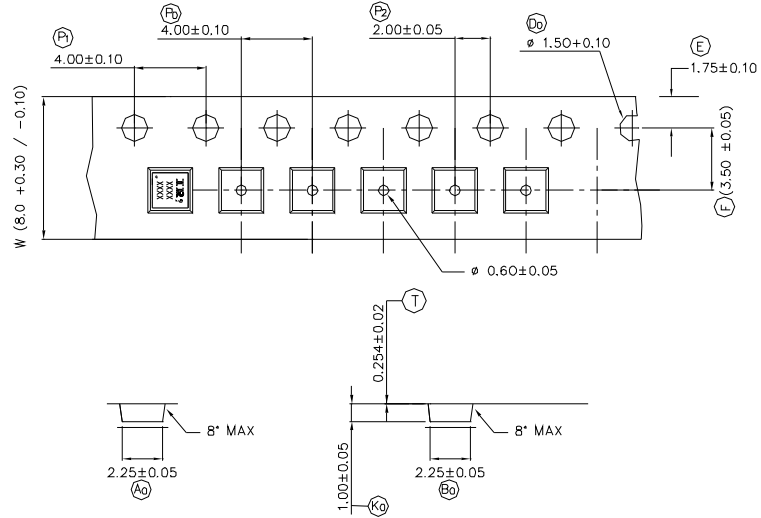
1. DIMENSION AND TOLERANCING CONFORM TO ASME Y14.5M-1994.
2. CONTROLLING DIMENSIONS : MILLIMETER
3. DIMENSION *b* APPLIES TO METALLIZED TERMINAL AND IS MEASURED BETWEEN 0.15 AND 0.30 mm. FROM TERMINAL TIP.

PQFN Part Marking

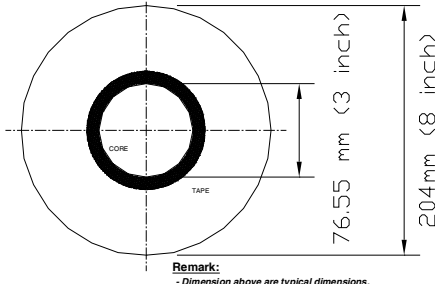
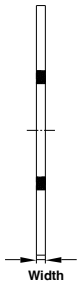


Note: For the most current drawing please refer to IR website at: <http://www.irf.com/package/>

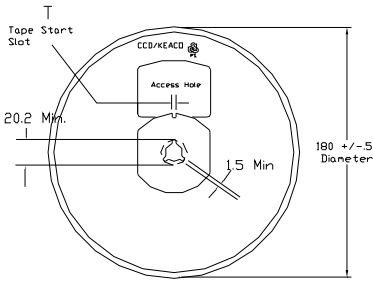
PQFN Tape and Reel



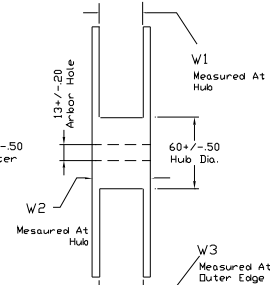
NOTE: The Surface Resistivity is $10^4 - 10^8$ OHM/SQ



Remark:
 - Dimension above are typical dimensions.
 - Cover tape thickness is 0.048mm +/- 0.005mm.
 - Surface resistivity $10E5 < R_s < 10E9$.



FRONT VIEW



SIDE VIEW

COVER TAPE (WIDTH)	TOLERANCE
5.4 mm	+/- 0.1 mm
9.5 mm	+/- 0.1 mm

TAPE WIDTH	T	W1	W2	W3	PART NO
8 MM	3 ± 0.50	84 ^{+1.5} _{-3.0}	14.4 Max	7.50 Min 10.9 Max	91586-1
12 MM	5 ± 0.50	12.4 ^{+2.0} _{-0.0}	18.4 Max	11.9 Min 15.4 Max	91586-2

Note: Surface resistivity is $\geq 1 \times 10^5$ but $< 1 \times 10^{12}$ ohm/sq.

Note: For the most current drawing please refer to IR website at: <http://www.irf.com/package/>

Qualification information[†]

Qualification level	Industrial ^{††} (per JEDEC JESD47F ^{†††} guidelines)	
Moisture Sensitivity Level	PQFN 2mm x 2mm	MSL1 (per IPC/JEDEC J-STD-020D ^{†††})
RoHS compliant	Yes	

† Qualification standards can be found at International Rectifier's web site

<http://www.irf.com/product-info/reliability>

†† Higher qualification ratings may be available should the user have such requirements. Please contact your International Rectifier sales representative for further information:

<http://www.irf.com/whoto-call/salesrep/>

††† Applicable version of JEDEC standard at the time of product release.

Revision History

Date	Comment
5/12/2014	<ul style="list-style-type: none"> • Updated ordering information to reflect the End-Of-life (EOL) of the mini-reel option (EOL notice #259) • Updated data sheet based on corporate template.
5/21/2014	<ul style="list-style-type: none"> • Updated qual level from "Consumer" to "Industrial" on page 1 & 9.