

## Ultra large bandwidth ESD protection

Datasheet - production data

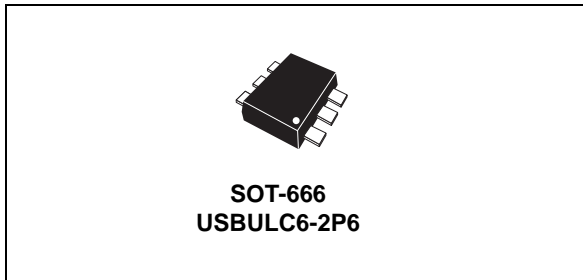

**Figure 1. Functional diagram**

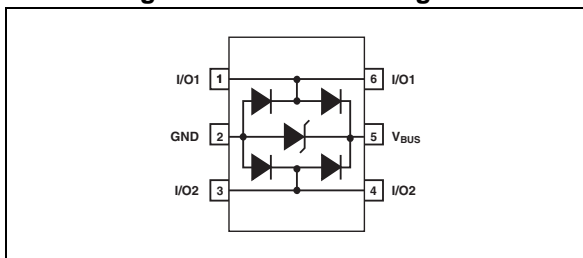

### Features

- 2 data line 15 kV ESD protection (air and contact discharge)
- Protects 5 V  $V_{BUS}$  when applicable
- Ultra low capacitance
- Very low leakage current: 0.5  $\mu$ A max.
- Fast response time compared with varistors
- SOT-666 package
- RoHS compliant

### Benefits

- ESD protection of  $V_{BUS}$  when applicable
- High bandwidth to minimize impact on data signal quality
- Low PCB space occupation
- Low leakage current for longer operation of battery powered devices
- High reliability offered by monolithic integration

### Complies with the following standards

- IEC 61000-4-2 level 4:
  - 15 kV (air discharge)
  - 8 kV (contact discharge)

### Applications

- USB 2.0 ports including high speed USB ports
- Up to 480 Mb/s as well as full and low speed USB ports
- Ethernet port: 10/100/1000 Mb/s
- Video line protection
- Portable electronics

### Description

The USBULC6-2P6 is a monolithic application specific device dedicated to ESD protection of high speed interfaces.

The ultra low line capacitance provides high bandwidth and secures a high level of signal integrity without compromising the protection of downstream sensitive chips against the most stringently characterized ESD strikes.

# 1 Characteristics

**Table 1. Absolute ratings**

Symbol	Parameter		Value	Unit
$V_{PP}$	Peak pulse voltage	IEC 61000-4-2 air discharge IEC 61000-4-2 contact discharge MIL STD883G-Method 3015-7	$\pm 15$ $\pm 15$ $\pm 25$	kV
$T_{stg}$	Storage temperature range		-55 to +150	$^{\circ}C$
$T_j$	Maximum junction temperature		+125	$^{\circ}C$
$T_L$	Lead solder temperature (10 seconds duration)		260	$^{\circ}C$

**Table 2. Electrical characteristics ( $T_{amb} = 25^{\circ}C$ )**

Symbol	Parameter	Test conditions	Value			Unit
			Min.	Typ.	Max.	
$I_{RM}$	Leakage current	$V_{RM} = 5 V$			0.5	$\mu A$
$V_{BR}$	Breakdown voltage between $V_{BUS}$ and GND	$I_R = 1 mA$	6			V
$V_{CL}$	Clamping voltage	$I_{PP} = 1 A, 8/20 \mu s$ Any I/O pin to GND			12	V
		$I_{PP} = 5 A, 8/20 \mu s$ Any I/O pin to GND			17	V
$C_{i/o-GND}$	Capacitance between I/O and GND	$V_R = 0 V, F = 1 MHz$ Any I/O pin to ground		1.0	1.2	pF
		$V_R = 0 V, F = 240 MHz$ Any I/O pin to ground		0.7	0.85	
$\Delta C_{i/o-GND}$	Capacitance variation between I/O and GND	$V_R = 0 V, F = 1 MHz$ Any I/O pin to ground		0.02		
$C_{i/o-i/o}$	Capacitance between I/O	$V_R = 0 V, F = 1 MHz$ Ground not connected		0.47	0.55	
		$V_R = 0 V, F = 240 MHz$ Ground not connected		0.45	0.55	

Figure 2. Relative variation of leakage current versus junction temperature (typical values)

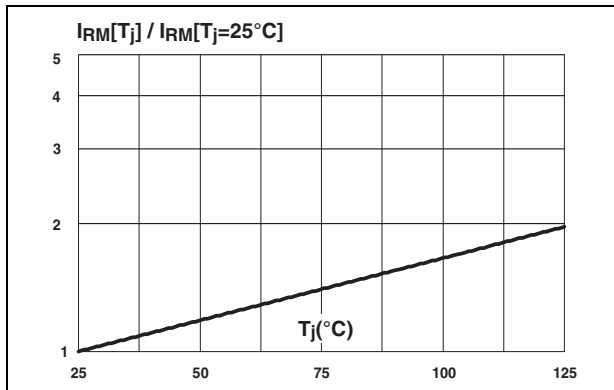

Figure 3. Typical frequency response

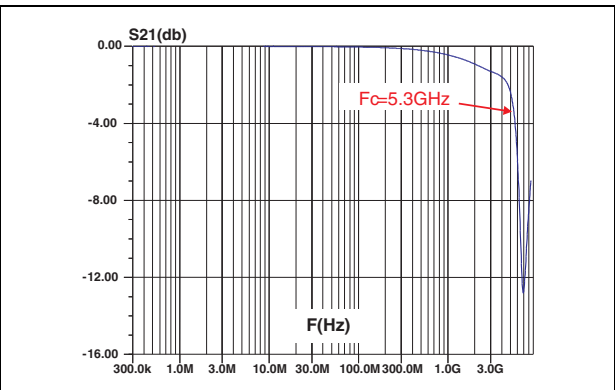

Figure 4. Crosstalk measurement

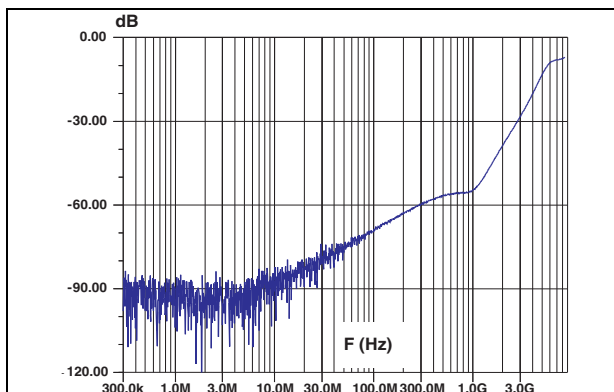

Figure 5. Line capacitance versus frequency (typical values)

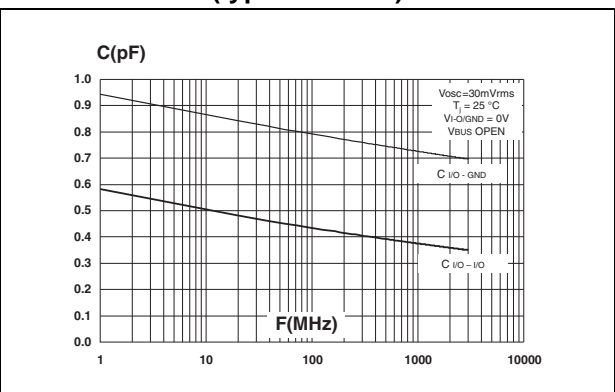

Figure 6. Remaining voltage on I/O1 after USBULC-2P6 during positive ESD surge (+15 kV air discharge)

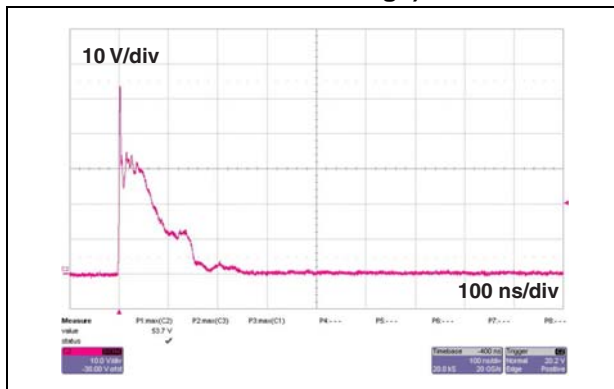

Figure 7. Remaining voltage on I/O2 after USBULC-2P6 during negative ESD surge (-15 kV air discharge)

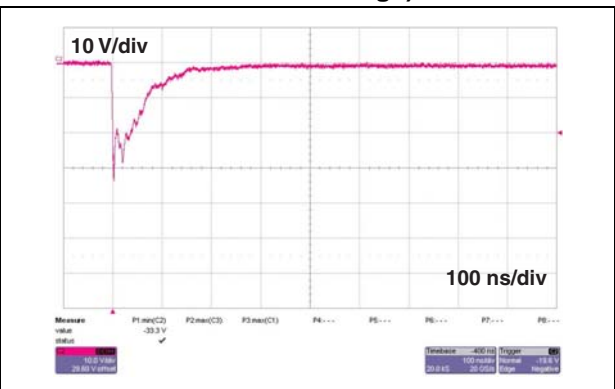

Figure 8. Remaining voltage on  $V_{BUS}$  after USBULC-2P6 during positive ESD surge (+15 kV air discharge)

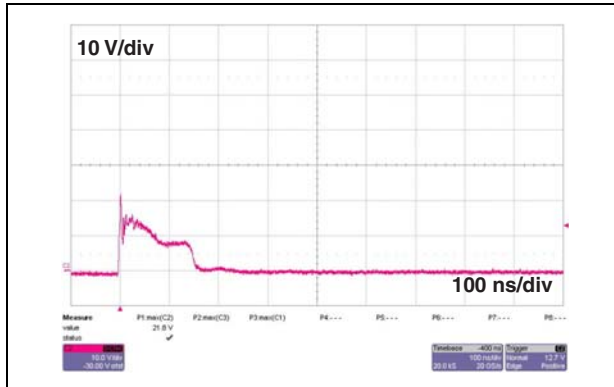

Figure 9. Remaining voltage on  $V_{BUS}$  after USBULC-2P6 during negative ESD surge (-15 kV air discharge)

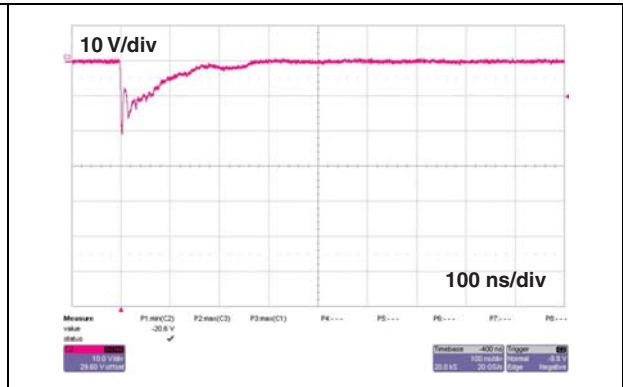

Figure 10. Eye diagram PCB only, 400 mV amplitude,  $F = 480$  Mbps

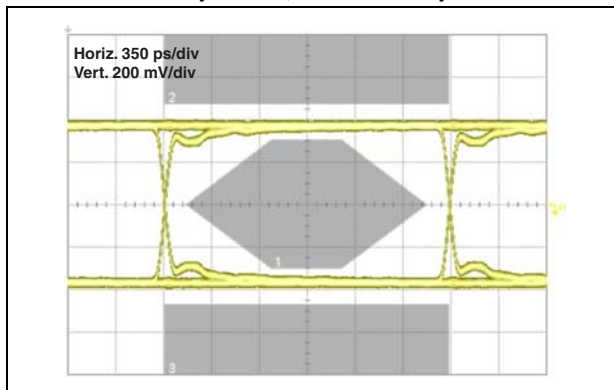

Figure 11. Eye diagram PCB + USBULC6-2P6, 400 mV amplitude,  $F = 480$  Mbps

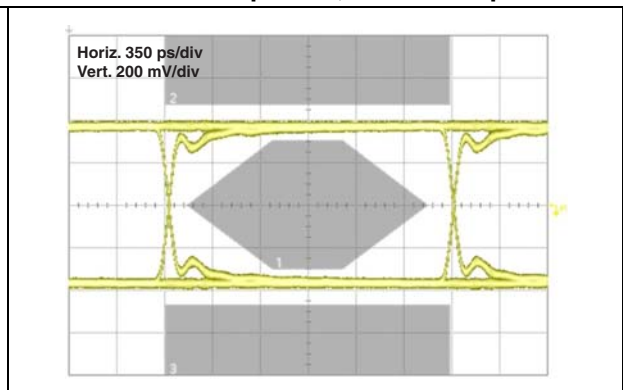
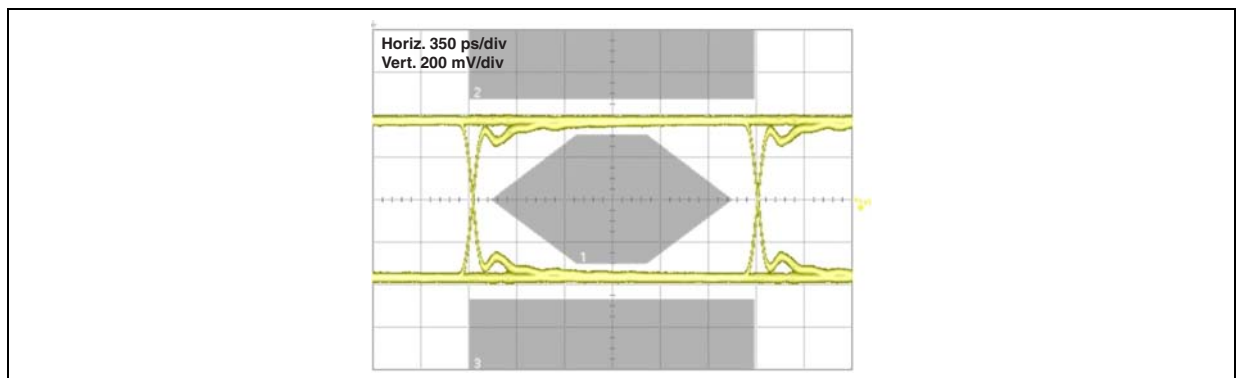
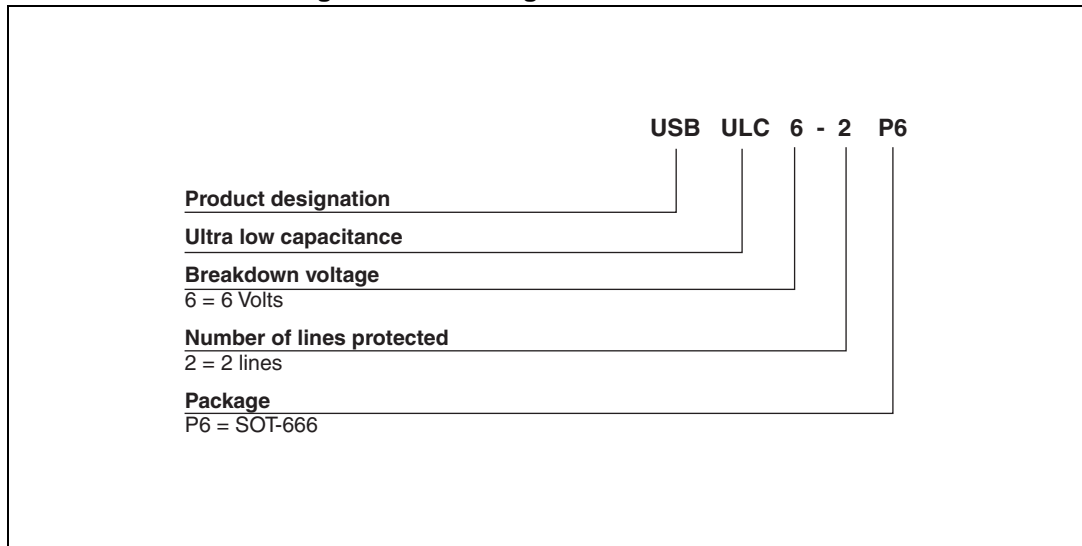

Figure 12. Eye diagram PCB + USBULC6-2P6, +5 V on  $V_{BUS}$ , decoupling capacitor 100 nF, 400 mV amplitude,  $F = 480$  Mbps



## 2 Ordering information scheme

Figure 13. Ordering information scheme



### 3 Package information

- Epoxy meets UL94, V0

In order to meet environmental requirements, ST offers these devices in ECOPACK® packages. These packages have a lead-free second level interconnect. The category of second level interconnect is marked on the package and on the inner box label, in compliance with JEDEC Standard JESD97. The maximum ratings related to soldering conditions are also marked on the inner box label. ECOPACK is an ST trademark. ECOPACK specifications are available at [www.st.com](http://www.st.com).

Table 3. SOT-666 dimensions

Ref.	Dimensions					
	Millimeters			Inches		
	Min.	Typ.	Max.	Min.	Typ.	Max.
A	0.45		0.60	0.018		0.024
A3	0.08		0.18	0.003		0.007
b	0.17		0.34	0.007		0.013
b1	0.19	0.27	0.34	0.007	0.011	0.013
D	1.50		1.70	0.059		0.067
E	1.50		1.70	0.059		0.067
E1	1.10		1.30	0.043		0.051
e		0.50			0.020	
L1		0.19			0.007	
L2	0.10		0.30	0.004		0.012
L3		0.10			0.004	

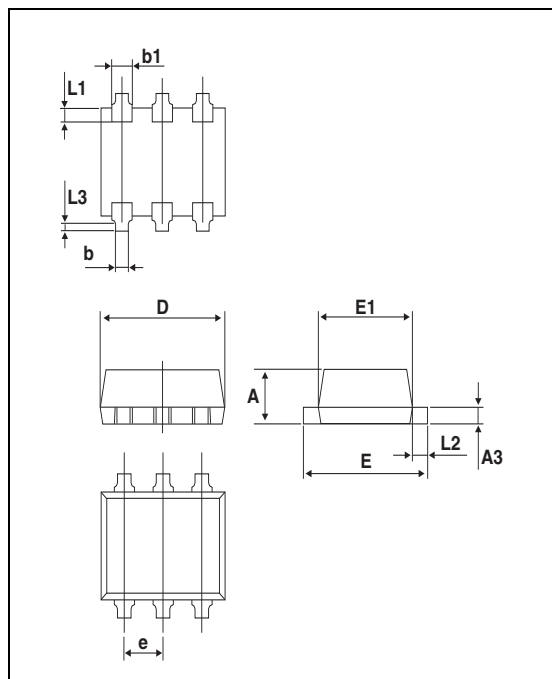

Figure 14. SOT-666 footprint

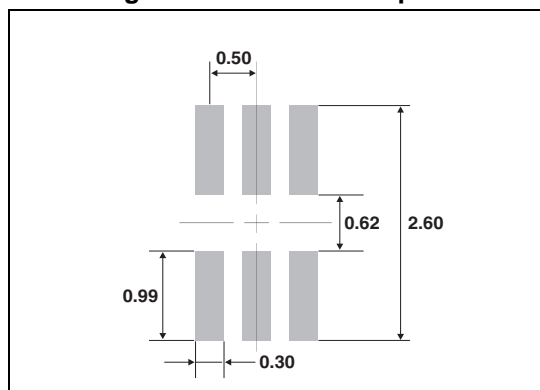
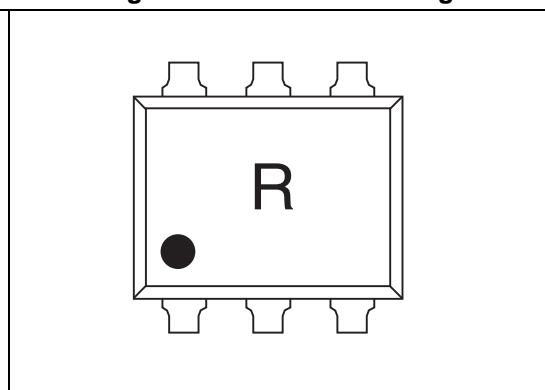

Figure 15. SOT-666 marking



## 4 Ordering information

Table 4. Ordering information

Ordering code	Marking	Package	Weight	Base qty	Delivery mode
USBULC6-2P6	R	SOT-666	2.9 mg	3000	Tape and reel

## 5 Revision history

Table 5. Document revision history

Date	Revision	Description of changes
31-Mar-2014	1	First issue.

**Please Read Carefully:**

Information in this document is provided solely in connection with ST products. STMicroelectronics NV and its subsidiaries ("ST") reserve the right to make changes, corrections, modifications or improvements, to this document, and the products and services described herein at any time, without notice.

All ST products are sold pursuant to ST's terms and conditions of sale.

Purchasers are solely responsible for the choice, selection and use of the ST products and services described herein, and ST assumes no liability whatsoever relating to the choice, selection or use of the ST products and services described herein.

No license, express or implied, by estoppel or otherwise, to any intellectual property rights is granted under this document. If any part of this document refers to any third party products or services it shall not be deemed a license grant by ST for the use of such third party products or services, or any intellectual property contained therein or considered as a warranty covering the use in any manner whatsoever of such third party products or services or any intellectual property contained therein.

**UNLESS OTHERWISE SET FORTH IN ST'S TERMS AND CONDITIONS OF SALE ST DISCLAIMS ANY EXPRESS OR IMPLIED WARRANTY WITH RESPECT TO THE USE AND/OR SALE OF ST PRODUCTS INCLUDING WITHOUT LIMITATION IMPLIED WARRANTIES OF MERCHANTABILITY, FITNESS FOR A PARTICULAR PURPOSE (AND THEIR EQUIVALENTS UNDER THE LAWS OF ANY JURISDICTION), OR INFRINGEMENT OF ANY PATENT, COPYRIGHT OR OTHER INTELLECTUAL PROPERTY RIGHT.**

**ST PRODUCTS ARE NOT DESIGNED OR AUTHORIZED FOR USE IN: (A) SAFETY CRITICAL APPLICATIONS SUCH AS LIFE SUPPORTING, ACTIVE IMPLANTED DEVICES OR SYSTEMS WITH PRODUCT FUNCTIONAL SAFETY REQUIREMENTS; (B) AERONAUTIC APPLICATIONS; (C) AUTOMOTIVE APPLICATIONS OR ENVIRONMENTS, AND/OR (D) AEROSPACE APPLICATIONS OR ENVIRONMENTS. WHERE ST PRODUCTS ARE NOT DESIGNED FOR SUCH USE, THE PURCHASER SHALL USE PRODUCTS AT PURCHASER'S SOLE RISK, EVEN IF ST HAS BEEN INFORMED IN WRITING OF SUCH USAGE, UNLESS A PRODUCT IS EXPRESSLY DESIGNATED BY ST AS BEING INTENDED FOR "AUTOMOTIVE, AUTOMOTIVE SAFETY OR MEDICAL" INDUSTRY DOMAINS ACCORDING TO ST PRODUCT DESIGN SPECIFICATIONS. PRODUCTS FORMALLY ESCC, QML OR JAN QUALIFIED ARE DEEMED SUITABLE FOR USE IN AEROSPACE BY THE CORRESPONDING GOVERNMENTAL AGENCY.**

Resale of ST products with provisions different from the statements and/or technical features set forth in this document shall immediately void any warranty granted by ST for the ST product or service described herein and shall not create or extend in any manner whatsoever, any liability of ST.

ST and the ST logo are trademarks or registered trademarks of ST in various countries.

Information in this document supersedes and replaces all information previously supplied.

The ST logo is a registered trademark of STMicroelectronics. All other names are the property of their respective owners.

© 2014 STMicroelectronics - All rights reserved

STMicroelectronics group of companies

Australia - Belgium - Brazil - Canada - China - Czech Republic - Finland - France - Germany - Hong Kong - India - Israel - Italy - Japan - Malaysia - Malta - Morocco - Philippines - Singapore - Spain - Sweden - Switzerland - United Kingdom - United States of America

[www.st.com](http://www.st.com)