

IS1U621/IS1U621L

Sensors for Remote Control

■ Features

1. Compact

(Volume : About 1/8 compared with **GP1U58X**)

2. High sensitivity (Ultimate distance : MIN. 8 m)

3. B.P.F. (Band Pass Frequency) center frequency : (TYP. 38kHz)

■ Applications

1. Audio equipment

2. Cameras

■ Absolute Maximum Ratings

($T_a=25^{\circ}\text{C}$)

Parameter	Symbol	Rating	Unit
Supply voltage	V_{CC}	0 to 6.0	V
*1 Operating temperature	T_{opr}	- 10 to +60	$^{\circ}\text{C}$
Storage temperature	T_{stg}	- 20 to +70	$^{\circ}\text{C}$
*2 Soldering temperature	T_{sol}	260	$^{\circ}\text{C}$

*1 No dew condensation is allowed.

*2 For 5 seconds at the position of 4.2 mm from the resin edge

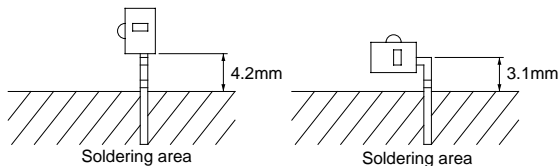

■ Outline Dimensions

(Unit : mm)

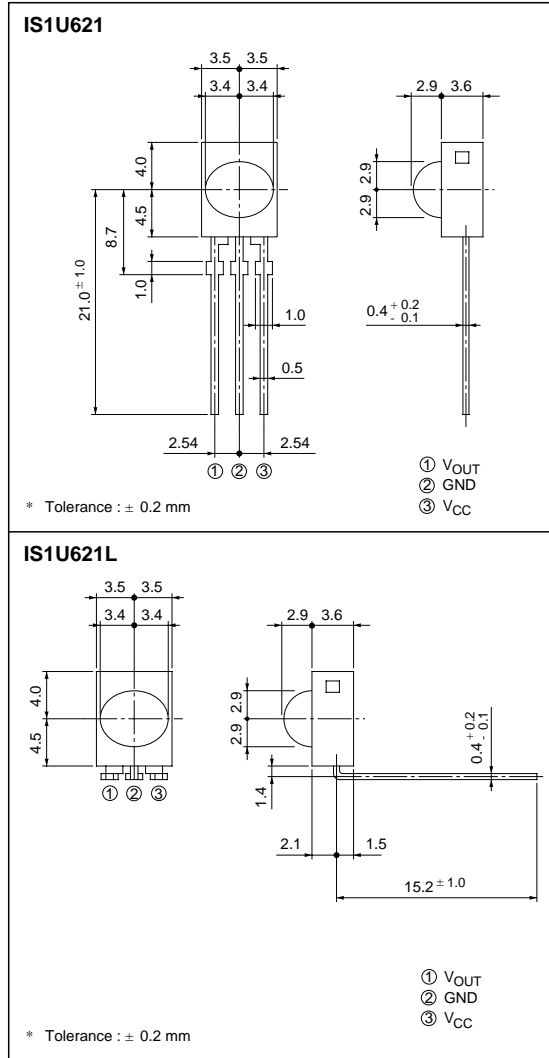

■ Recommended Operating Conditions

Parameter	Symbol	Recommended operating conditions	Unit
Operating supply voltage	V_{CC}	4.7 to 5.3	V

Electrical Characteristics

($T_a=25^{\circ}\text{C}$, $V_{cc} = +5\text{V}$)

Parameter	Symbol	Conditions	MIN.	TYP.	MAX.	Unit
Dissipation current	I_{cc}	No input light, Output terminal OPEN	-	2.8	4.5	mA
High level output voltage	V_{OH}	*3, Output terminal OPEN	$V_{cc} - 0.2$	-	-	V
Low level output voltage	V_{OL}	*3, *4	-	0.45	0.6	V
High level pulse width	T_1	*3	400	-	800	μs
Low level pulse width	T_2		400	-	800	μs
B.P.F. center frequency	f_o	-	-	38	-	kHz
*5 Linear ultimate distance	L	$E_e < 10\text{ lx}$	8.0	-	-	m

*3 The burst wave as shown in the following figure shall be transmitted.

*4 Pull-up resistance : 2.2k Ω

*5 By SHARP transmitter

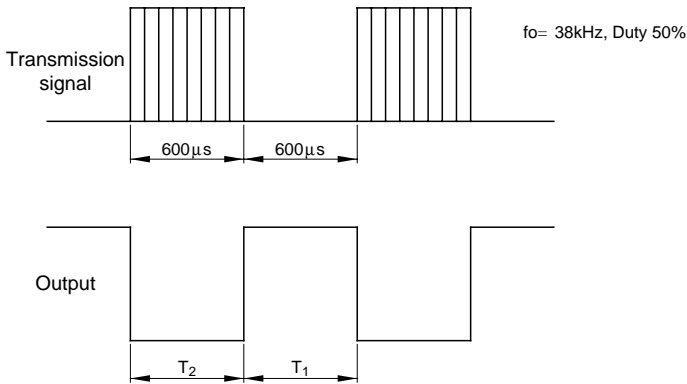

Internal Block Diagram

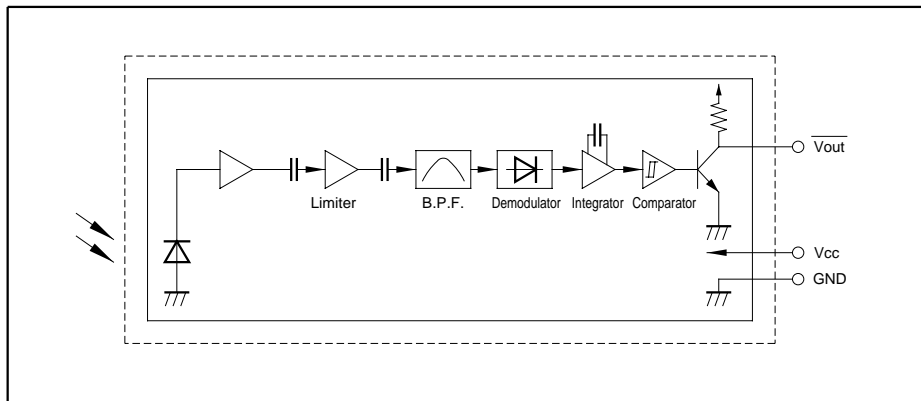

■ Performance

Using the transmitter shown in Fig. 1, the output signal of the light detecting unit is good enough to meet the following items in the standard optical system in Fig. 2.

(1) Linear reception distance characteristics

When $L=0.2$ to 8 m, $E_e < 10$ lx (*6) and $\phi = 0^\circ$ in Fig. 2, the output signal shall meet the electrical characteristics in the attached list.

(2) Sensitivity angle reception distance characteristics

When $L=0.2$ to 5 m, $E_e < 10$ lx (*6) and $\phi \leq 30^\circ$ in the direction X and $\theta = 0^\circ$ in the direction Y in Fig. 2, the output signal shall meet the electrical characteristics in the attached list. Further, the electrical characteristics shall be met when $L=0.2$ to 5 m, $E_e < 10$ lx (*6) and $\phi = 0^\circ$ in the direction X and $\theta \leq 15^\circ$ in the direction Y.

*6 It refers to detector face illuminance.

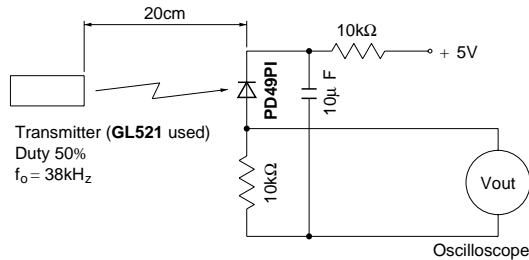

Fig. 1 Transmitter

In the above figure, the transmitter should be set so that the output V_{out} can be $40mV_{p-p}$.

However, the **PD49PI** to be used here should be of the short-circuit current $I_{SC} = 2.6 \mu A$ at $E_v = 100$ lx.

(E_v is an illuminance by CIE standard light source A (tungsten lamp).)

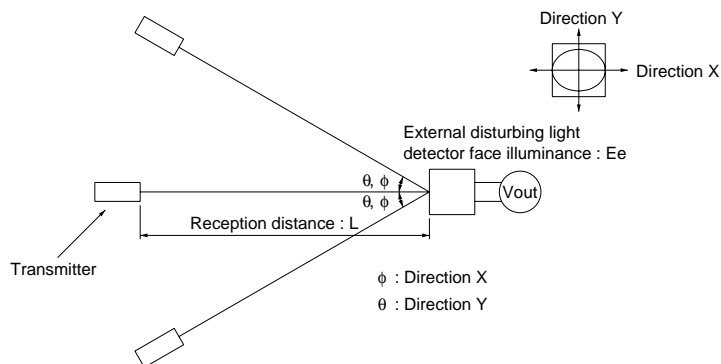

Fig. 2 Standard optical system

Fig. 1 B.P.F. Frequency Characteristics (TYP.)

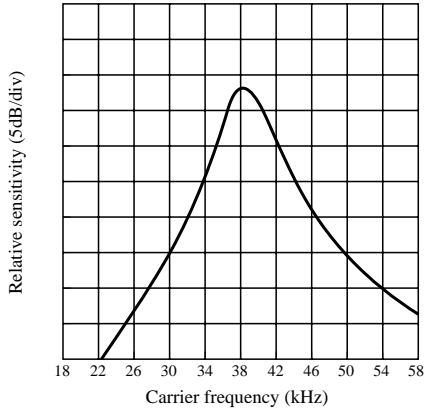

Fig. 2 Sensitivity Angle (Direction X) Characteristics (TYP.) for Reference

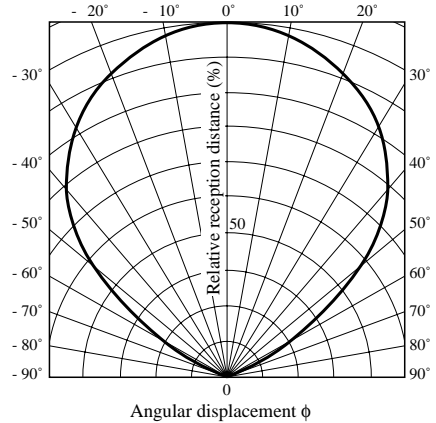

Fig. 3 Sensitivity Angle (Direction Y) Characteristics (TYP.) for Reference

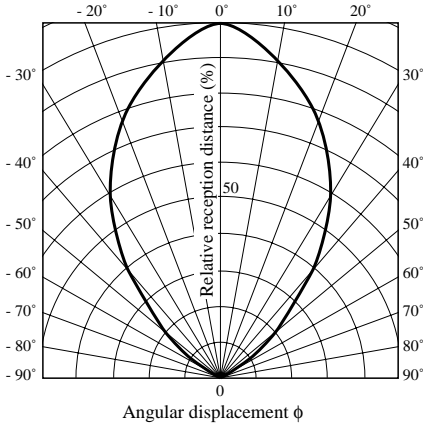

Fig. 4 Relative Reception Distance vs. Ambient Temperature (TYP.) for Reference

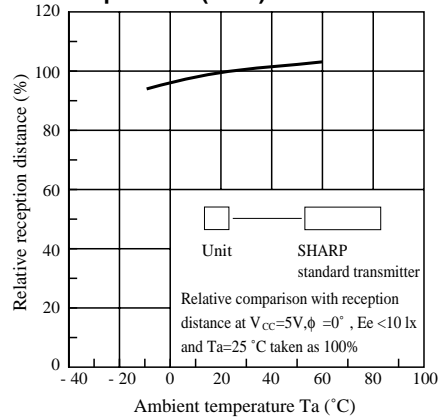
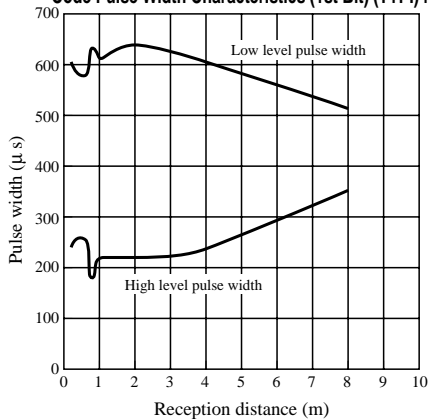

Fig. 5 AEHA (Japan Association of Electrical Home Appliances) Code Pulse Width Characteristics (1st Bit) (TYP.) for Reference



(Conditions)

Unit AEHA code generating transmitter

$V_{CC}=5V, T_a=RT, \phi = 0^\circ, E_e < 10 \text{ lx}$

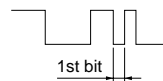

$T = 430\mu\text{s}$

Fig. 6 Spectral Sensitivity for Reference

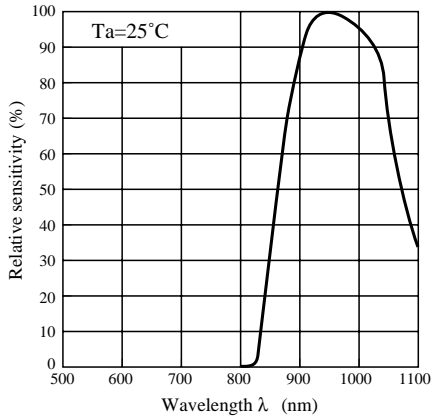

■ Precautions for Operation

(1) Use the light emitting unit (remote control transmitter), in consideration of performance, characteristics, operating conditions of light emitting device and the characteristics of the light detecting unit.

(2) Pay attention to a malfunction of the light detecting unit when the surface is stained with dust and refuse.

Care must be taken not to touch the light detector surface.

- Conduct cleaning as follows.

(3) Cleaning

Solvent dip cleaning : Solvent temperature of 45 °C max., dipping time : Within 3 minutes

Ultrasonic cleaning : Elements are affected differently depending on the size of cleaning bath, ultrasonic output, time, size of PWB and mounting method of elements.

Conduct trial cleaning on actual operating conditions in advance to make sure that no problem results.

- Use the following solvents only.

Solvents: Ethyl alcohol, methyl alcohol or isopropyl alcohol

(4) To avoid the electrostatic breakdown of IC, handle the unit under the condition of grounding with human body, soldering iron, etc.

(5) Do not apply unnecessary force to the terminal.

(6) Example of recommended external circuit (mount outer mounting parts near the sensor as much as possible.)

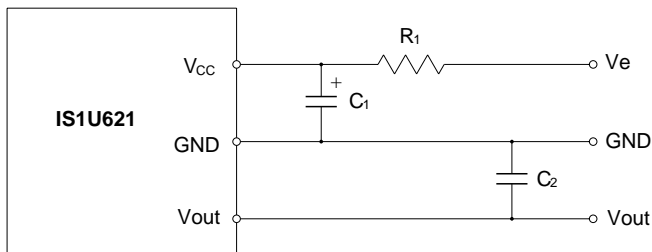

(Circuit constant)

$R_1 = 47 \Omega \pm 5\%$

$C_1 = 47 \mu F$

$C_2 = 1\ 000 pF$

Connect capacitor C_2 between Vout and GND terminals as shown above

NOTICE

- The circuit application examples in this publication are provided to explain representative applications of SHARP devices and are not intended to guarantee any circuit design or license any intellectual property rights. SHARP takes no responsibility for any problems related to any intellectual property right of a third party resulting from the use of SHARP's devices.
- Contact SHARP in order to obtain the latest device specification sheets before using any SHARP device. SHARP reserves the right to make changes in the specifications, characteristics, data, materials, structure, and other contents described herein at any time without notice in order to improve design or reliability. Manufacturing locations are also subject to change without notice.
- Observe the following points when using any devices in this publication. SHARP takes no responsibility for damage caused by improper use of the devices which does not meet the conditions and absolute maximum ratings to be used specified in the relevant specification sheet nor meet the following conditions:
 - (i) The devices in this publication are designed for use in general electronic equipment designs such as:
 - Personal computers
 - Office automation equipment
 - Telecommunication equipment [terminal]
 - Test and measurement equipment
 - Industrial control
 - Audio visual equipment
 - Consumer electronics
 - (ii) Measures such as fail-safe function and redundant design should be taken to ensure reliability and safety when SHARP devices are used for or in connection with equipment that requires higher reliability such as:
 - Transportation control and safety equipment (i.e., aircraft, trains, automobiles, etc.)
 - Traffic signals
 - Gas leakage sensor breakers
 - Alarm equipment
 - Various safety devices, etc.
 - (iii) SHARP devices shall not be used for or in connection with equipment that requires an extremely high level of reliability and safety such as:
 - Space applications
 - Telecommunication equipment [trunk lines]
 - Nuclear power control equipment
 - Medical and other life support equipment (e.g., scuba).
- Contact a SHARP representative in advance when intending to use SHARP devices for any "specific" applications other than those recommended by SHARP or when it is unclear which category mentioned above controls the intended use.
- If the SHARP devices listed in this publication fall within the scope of strategic products described in the Foreign Exchange and Foreign Trade Control Law of Japan, it is necessary to obtain approval to export such SHARP devices.
- This publication is the proprietary product of SHARP and is copyrighted, with all rights reserved. Under the copyright laws, no part of this publication may be reproduced or transmitted in any form or by any means, electronic or mechanical, for any purpose, in whole or in part, without the express written permission of SHARP. Express written permission is also required before any use of this publication may be made by a third party.
- Contact and consult with a SHARP representative if there are any questions about the contents of this publication.