

HC-M-KV-M20(9-13)

Order No.: 1690561

The illustration shows version HC-M-KV-M20

<http://eshop.phoenixcontact.de/phoenix/treeViewClick.do?UID=1690561>

Metal screw connection up to 5 bar, thread length: 6 mm, cable diameter: 9 - 13 mm, WAF 22, screw connection: M20

Commercial data

GTIN (EAN)	 4 017918 822620
sales group	D290
Pack	25 pcs.
Customs tariff	74199990
Catalog page information	Page 521 (PC-2009)

Product notes

WEEE/RoHS-compliant since:
02/16/2006

<http://www.download.phoenixcontact.com>
Please note that the data given here has been taken from the online catalog. For comprehensive information and data, please refer to the user documentation. The General Terms and Conditions of Use apply to Internet downloads.

Technical data

General data

Type of the screw connection	M20
Cable gland material	Nickel-plated brass
Seal material	Neoprene
Cable seal material	Neoprene
Material, O-ring	NBR

Wrench size, union nut	22 mm
Wrench size, support	22 mm
Thread type connection side 1	M20
Length of the connecting thread	6.00 mm
External cable diameter	9 mm ... 13 mm
Conductor sealing range	9.00 mm ... 13.00 mm
Tightening torque, union nut	7.50 Nm
Degree of protection	IP68, to 5 bar
Ambient temperature (operation)	-20 °C ... 100 °C

Certificates / Approvals



Certification

GOST

Diagrams/Drawings

Dimensioned drawing

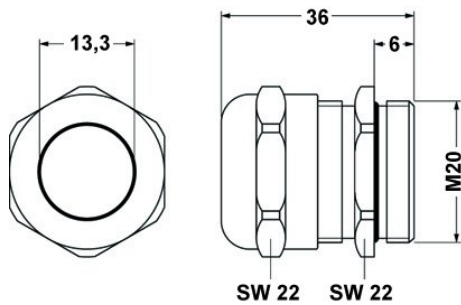

Address

PHOENIX CONTACT Deutschland GmbH
Flachmarktstr. 8
32825 Blomberg, Germany
Phone +49 5235 3 12000
Fax +49 5235 3 41200
<http://www.phoenixcontact.de>



© 2010 Phoenix Contact
Technical modifications reserved;