

Aug.1.2018 Copyright 2018 HIROSE ELECTRIC CO., LTD. All Rights Reserved.
 In case that the application demands a high level of reliability, such as automotive,
 please contact a company representative for further information.

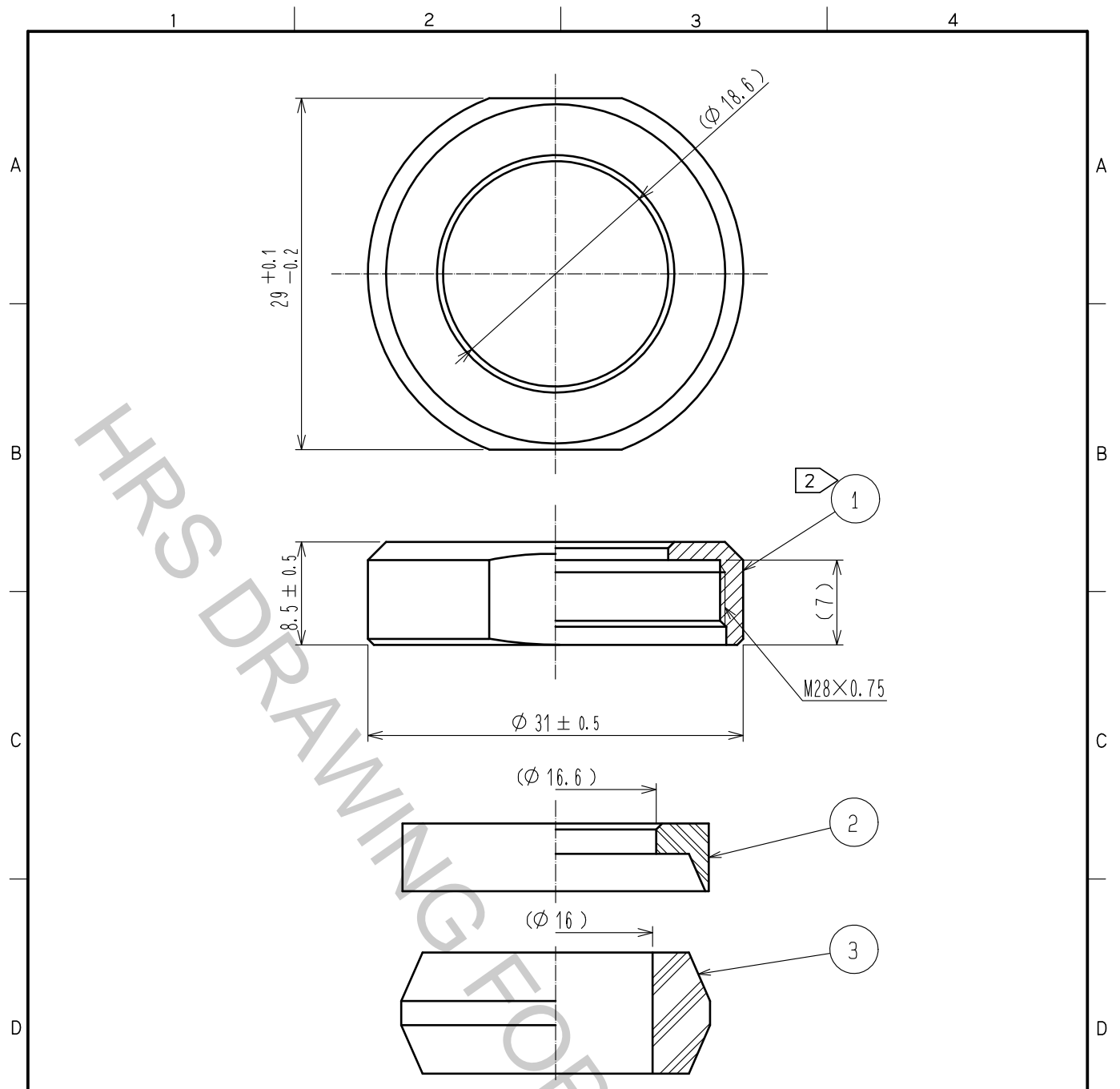

- Notes
- This product is delivered disassembled.
 - The recommended clamp torque of ref. No. ① : 5 to 5.5 N·m .
 LOCTITE 263, HENKEL JAPAN or equivalent is recommended to prevent
 ref. No. ① from loosening.
 - The cable pull and twisting strength, waterproof tightness and other characteristics
 may differ, depending on the cable structure. Please confirm before the use.

2	PPS	(Black) UL94V-0						
1	Brass	Black chrome plating	3	Acrylonitrile butadiene rubber	(Gray)			
NO.	MATERIAL	FINISH .	REMARKS	NO.	MATERIAL	FINISH .	REMARKS	
UNITS mm		SCALE 2 : 1	COUNT 	DESCRIPTION OF REVISIONS		DESIGNED	CHECKED	DATE
HIROSE ELECTRIC CO., LTD.	APPROVED	·HY. KOBAYASHI	18.02.26	DRAWING NO.	EDC-110633-31-00			
	CHECKED	·HY. KOBAYASHI	18.02.26	PART NO.	JR25WCCA-16(31)			
	DESIGNED	·TH. KAMEYA	18.02.24	CODE NO.	CL114-2091-8-31			
	DRAWN	·MK. INOUE	18.02.14		1/1			