

MUN2130, MMUN2130L, MUN5130, DTA113EE, DTA113EM3, NSBA113EF3

Digital Transistors (BRT) R1 = 1 kΩ, R2 = 1 kΩ

PNP Transistors with Monolithic Bias Resistor Network

This series of digital transistors is designed to replace a single device and its external resistor bias network. The Bias Resistor Transistor (BRT) contains a single transistor with a monolithic bias network consisting of two resistors; a series base resistor and a base-emitter resistor. The BRT eliminates these individual components by integrating them into a single device. The use of a BRT can reduce both system cost and board space.

Features

- Simplifies Circuit Design
- Reduces Board Space
- Reduces Component Count
- S and NSV Prefix for Automotive and Other Applications Requiring Unique Site and Control Change Requirements; AEC-Q101 Qualified and PPAP Capable
- These Devices are Pb-Free, Halogen Free/BFR Free and are RoHS Compliant

MAXIMUM RATINGS (T_A = 25°C)

| Rating | Symbol | Max | Unit |
|--------------------------------|----------------------|-----|------|
| Collector-Base Voltage | V _{CBO} | 50 | Vdc |
| Collector-Emitter Voltage | V _{CEO} | 50 | Vdc |
| Collector Current - Continuous | I _C | 100 | mAdc |
| Input Forward Voltage | V _{IN(fwd)} | 10 | Vdc |
| Input Reverse Voltage | V _{IN(rev)} | 10 | Vdc |

Stresses exceeding those listed in the Maximum Ratings table may damage the device. If any of these limits are exceeded, device functionality should not be assumed, damage may occur and reliability may be affected.



ON Semiconductor®

www.onsemi.com

PIN CONNECTIONS



MARKING DIAGRAMS

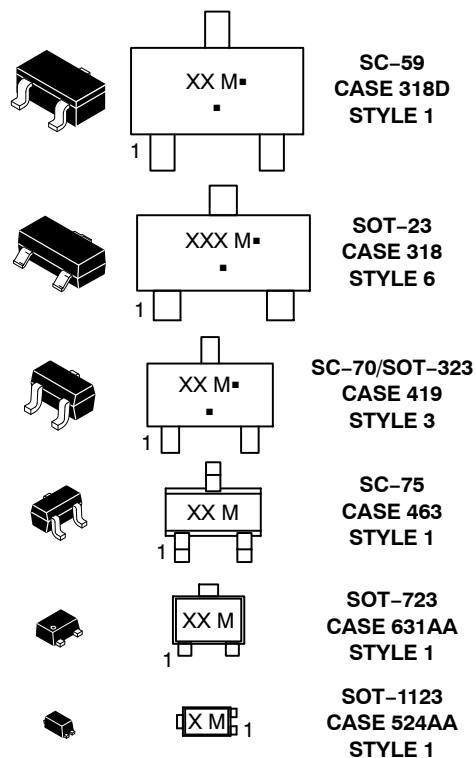

XXX = Specific Device Code
M = Date Code*
■ = Pb-Free Package

(Note: Microdot may be in either location)

*Date Code orientation may vary depending upon manufacturing location.

ORDERING INFORMATION

See detailed ordering, marking, and shipping information on page 2 of this data sheet.

MUN2130, MMUN2130L, MUN5130, DTA113EE, DTA113EM3, NSBA113EF3

Table 1. ORDERING INFORMATION

| Device | Part Marking | Package | Shipping† |
|--------------------------------|--------------|----------------------------|--------------------|
| MUN2130T1G | 6G | SC-59 (Pb-Free) | 3000 / Tape & Reel |
| MMUN2130LT1G | A6G | SOT-23 (Pb-Free) | 3000 / Tape & Reel |
| MUN5130T1G | 6G | SC-70/SOT-323 (Pb-Free) | 3000 / Tape & Reel |
| DTA113EET1G | 6G | SC-75 (Pb-Free) | 3000 / Tape & Reel |
| DTA113EM3T5G, NSVDTA113EM3T5G* | 7E | SOT-723 (Pb-Free) | 8000 / Tape & Reel |
| NSBA113EF3T5G | L (180°)** | SOT-1123 (Pb-Free) | 8000 / Tape & Reel |

†For information on tape and reel specifications, including part orientation and tape sizes, please refer to our Tape and Reel Packaging Specifications Brochure, BRD8011/D.

** (xx°) = Degree rotation in the clockwise direction.

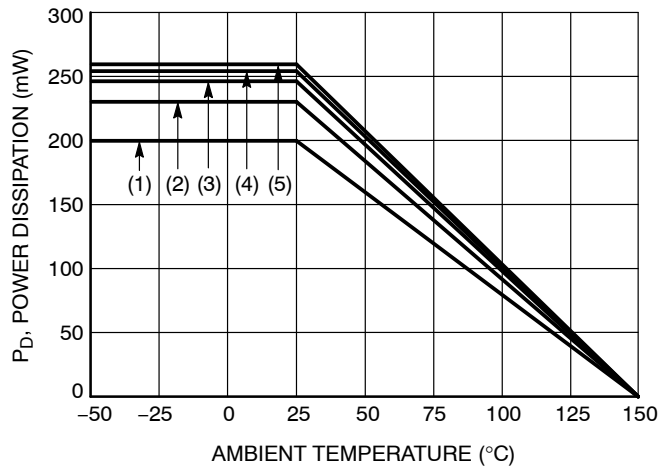

- (1) SC-75 and SC-70/SOT323; Minimum Pad
- (2) SC-59; Minimum Pad
- (3) SOT-23; Minimum Pad
- (4) SOT-1123; 100 mm², 1 oz. copper trace
- (5) SOT-723; Minimum Pad

Figure 1. Derating Curve

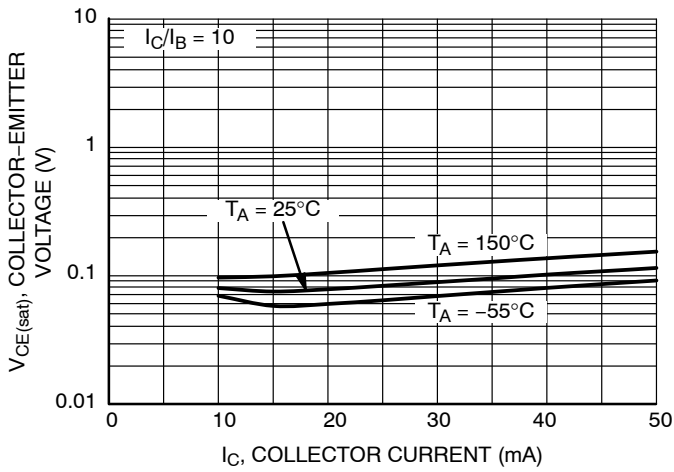

Figure 2. $V_{CE(sat)}$ vs. I_C

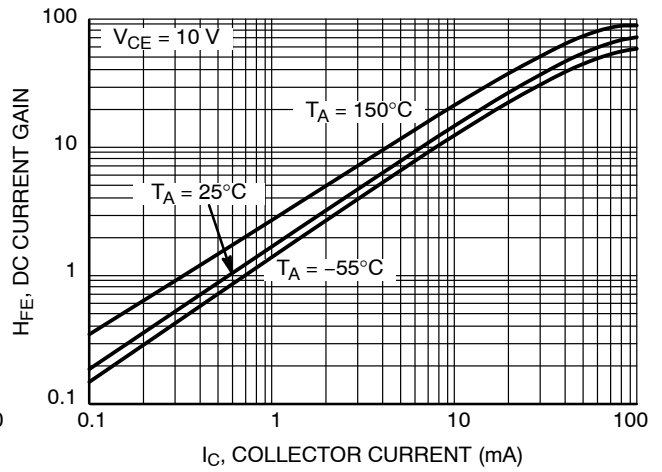

Figure 3. DC Current Gain

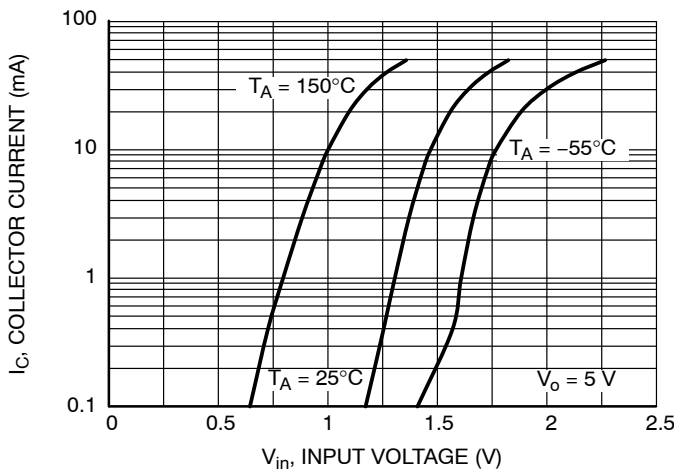

Figure 4. Output Current vs. Input Voltage

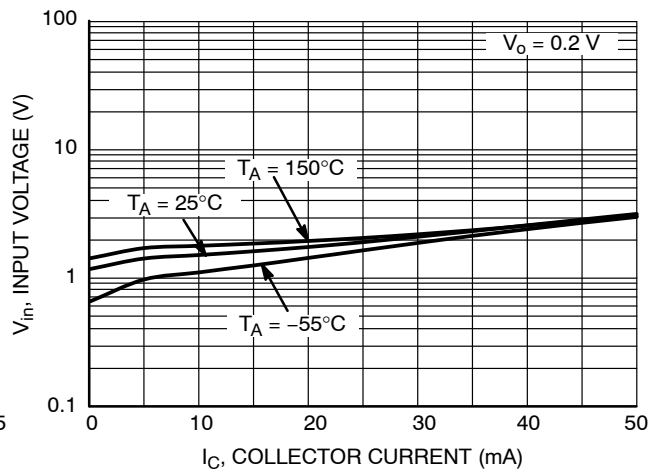

Figure 5. Input Voltage vs. Output Current

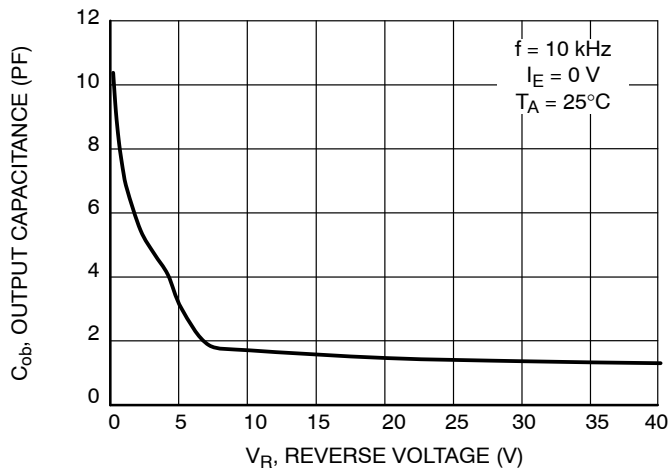

Figure 6. Output Capacitance

MUN2130, MMUN2130L, MUN5130, DTA113EE, DTA113EM3, NSBA113EF3

Table 2. THERMAL CHARACTERISTICS

| Characteristic | Symbol | Max | Unit |
|---|--|-----------------------------------|----------------------------|
| THERMAL CHARACTERISTICS (SC-59) (MUN2130) | | | |
| Total Device Dissipation $T_A = 25^\circ\text{C}$ Derate above 25°C | (Note 1) (Note 2) (Note 1) (Note 2) | P_D 230 338 1.8 2.7 | mW mW/ $^\circ\text{C}$ |
| Thermal Resistance, Junction to Ambient | (Note 1) (Note 2) | $R_{\theta JA}$ 540 370 | $^\circ\text{C/W}$ |
| Thermal Resistance, Junction to Lead | (Note 1) (Note 2) | $R_{\theta JL}$ 264 287 | $^\circ\text{C/W}$ |
| Junction and Storage Temperature Range | T_J, T_{stg} | -55 to +150 | $^\circ\text{C}$ |
| THERMAL CHARACTERISTICS (SOT-23) (MMUN2130L) | | | |
| Total Device Dissipation $T_A = 25^\circ\text{C}$ Derate above 25°C | (Note 1) (Note 2) (Note 1) (Note 2) | P_D 246 400 2.0 3.2 | mW mW/ $^\circ\text{C}$ |
| Thermal Resistance, Junction to Ambient | (Note 1) (Note 2) | $R_{\theta JA}$ 508 311 | $^\circ\text{C/W}$ |
| Thermal Resistance, Junction to Lead | (Note 1) (Note 2) | $R_{\theta JL}$ 174 208 | $^\circ\text{C/W}$ |
| Junction and Storage Temperature Range | T_J, T_{stg} | -55 to +150 | $^\circ\text{C}$ |
| THERMAL CHARACTERISTICS (SC-70/SOT-323) (MUN5130) | | | |
| Total Device Dissipation $T_A = 25^\circ\text{C}$ Derate above 25°C | (Note 1) (Note 2) (Note 1) (Note 2) | P_D 202 310 1.6 2.5 | mW mW/ $^\circ\text{C}$ |
| Thermal Resistance, Junction to Ambient | (Note 1) (Note 2) | $R_{\theta JA}$ 618 403 | $^\circ\text{C/W}$ |
| Thermal Resistance, Junction to Lead | (Note 1) (Note 2) | $R_{\theta JL}$ 280 332 | $^\circ\text{C/W}$ |
| Junction and Storage Temperature Range | T_J, T_{stg} | -55 to +150 | $^\circ\text{C}$ |
| THERMAL CHARACTERISTICS (SC-75) (DTA113EE) | | | |
| Total Device Dissipation $T_A = 25^\circ\text{C}$ Derate above 25°C | (Note 1) (Note 2) (Note 1) (Note 2) | P_D 200 300 1.6 2.4 | mW mW/ $^\circ\text{C}$ |
| Thermal Resistance, Junction to Ambient | (Note 1) (Note 2) | $R_{\theta JA}$ 600 400 | $^\circ\text{C/W}$ |
| Junction and Storage Temperature Range | T_J, T_{stg} | -55 to +150 | $^\circ\text{C}$ |
| THERMAL CHARACTERISTICS (SOT-723) (DTA113EM3) | | | |
| Total Device Dissipation $T_A = 25^\circ\text{C}$ Derate above 25°C | (Note 1) (Note 2) (Note 1) (Note 2) | P_D 260 600 2.0 4.8 | mW mW/ $^\circ\text{C}$ |
| Thermal Resistance, Junction to Ambient | (Note 1) (Note 2) | $R_{\theta JA}$ 480 205 | $^\circ\text{C/W}$ |
| Junction and Storage Temperature Range | T_J, T_{stg} | -55 to +150 | $^\circ\text{C}$ |

- FR-4 @ Minimum Pad.
- FR-4 @ 1.0 x 1.0 Inch Pad.
- FR-4 @ 100 mm², 1 oz. copper traces, still air.
- FR-4 @ 500 mm², 1 oz. copper traces, still air.

MUN2130, MMUN2130L, MUN5130, DTA113EE, DTA113EM3, NSBA113EF3

Table 2. THERMAL CHARACTERISTICS

| Characteristic | Symbol | Max | Unit |
|--|-----------------|-------------|---------------------------|
| THERMAL CHARACTERISTICS (SOT-1123) (NSBA113EF3) | | | |
| Total Device Dissipation $T_A = 25^\circ\text{C}$ | P_D | 254 297 | mW |
| Derate above 25°C | | 2.0 2.4 | mW/ $^\circ\text{C}$ |
| Thermal Resistance, Junction to Ambient | $R_{\theta JA}$ | 493 421 | $^\circ\text{C}/\text{W}$ |
| Thermal Resistance, Junction to Lead | $R_{\theta JL}$ | 193 | $^\circ\text{C}/\text{W}$ |
| Junction and Storage Temperature Range | T_J, T_{stg} | -55 to +150 | $^\circ\text{C}$ |

- FR-4 @ Minimum Pad.
- FR-4 @ 1.0 x 1.0 Inch Pad.
- FR-4 @ 100 mm², 1 oz. copper traces, still air.
- FR-4 @ 500 mm², 1 oz. copper traces, still air.

Table 3. ELECTRICAL CHARACTERISTICS ($T_A = 25^\circ\text{C}$, unless otherwise noted)

| Characteristic | Symbol | Min | Typ | Max | Unit |
|--|---------------|-----|-----|------|------------|
| OFF CHARACTERISTICS | | | | | |
| Collector-Base Cutoff Current ($V_{CB} = 50\text{ V}, I_E = 0$) | I_{CBO} | - | - | 100 | nAdc |
| Collector-Emitter Cutoff Current ($V_{CE} = 50\text{ V}, I_B = 0$) | I_{CEO} | - | - | 500 | nAdc |
| Emitter-Base Cutoff Current ($V_{EB} = 6.0\text{ V}, I_C = 0$) | I_{EBO} | - | - | 4.3 | mAdc |
| Collector-Base Breakdown Voltage ($I_C = 10\ \mu\text{A}, I_E = 0$) | $V_{(BR)CBO}$ | 50 | - | - | Vdc |
| Collector-Emitter Breakdown Voltage (Note 5) ($I_C = 2.0\text{ mA}, I_B = 0$) | $V_{(BR)CEO}$ | 50 | - | - | Vdc |
| ON CHARACTERISTICS | | | | | |
| DC Current Gain (Note 5) ($I_C = 5.0\text{ mA}, V_{CE} = 10\text{ V}$) | h_{FE} | 3.0 | 5.0 | - | |
| Collector-Emitter Saturation Voltage (Note 5) ($I_C = 10\text{ mA}, I_B = 5.0\text{ mA}$) | $V_{CE(sat)}$ | - | - | 0.25 | Vdc |
| Input Voltage (off) ($V_{CE} = 5.0\text{ V}, I_C = 100\ \mu\text{A}$) | $V_{i(off)}$ | - | 1.2 | 0.5 | Vdc |
| Input Voltage (on) ($V_{CE} = 0.3\text{ V}, I_C = 20\text{ mA}$) | $V_{i(on)}$ | 2.0 | 1.6 | - | Vdc |
| Output Voltage (on) ($V_{CC} = 5.0\text{ V}, V_B = 2.5\text{ V}, R_L = 1.0\text{ k}\Omega$) | V_{OL} | - | - | 0.2 | Vdc |
| Output Voltage (off) ($V_{CC} = 5.0\text{ V}, V_B = 0.05\text{ V}, R_L = 1.0\text{ k}\Omega$) | V_{OH} | 4.9 | - | - | Vdc |
| Input Resistor | R_1 | 0.7 | 1.0 | 1.3 | k Ω |
| Resistor Ratio | R_1/R_2 | 0.8 | 1.0 | 1.2 | |

Product parametric performance is indicated in the Electrical Characteristics for the listed test conditions, unless otherwise noted. Product performance may not be indicated by the Electrical Characteristics if operated under different conditions.

- Pulsed Condition: Pulse Width = 300 msec, Duty Cycle $\leq 2\%$.

PACKAGE DIMENSIONS

SC-59
CASE 318D-04
ISSUE H

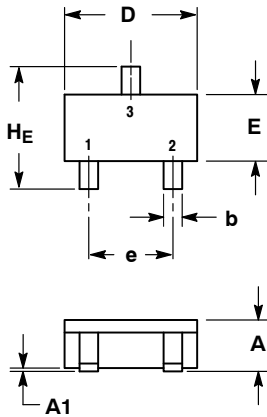

- NOTES:
1. DIMENSIONING AND TOLERANCING PER ANSI Y14.5M, 1982.
2. CONTROLLING DIMENSION: MILLIMETER.

| DIM | MILLIMETERS | | | INCHES | | |
|-----|-------------|------|------|--------|-------|-------|
| | MIN | NOM | MAX | MIN | NOM | MAX |
| A | 1.00 | 1.15 | 1.30 | 0.039 | 0.045 | 0.051 |
| A1 | 0.01 | 0.06 | 0.10 | 0.001 | 0.002 | 0.004 |
| b | 0.35 | 0.43 | 0.50 | 0.014 | 0.017 | 0.020 |
| c | 0.09 | 0.14 | 0.18 | 0.003 | 0.005 | 0.007 |
| D | 2.70 | 2.90 | 3.10 | 0.106 | 0.114 | 0.122 |
| E | 1.30 | 1.50 | 1.70 | 0.051 | 0.059 | 0.067 |
| e | 1.70 | 1.90 | 2.10 | 0.067 | 0.075 | 0.083 |
| L | 0.20 | 0.40 | 0.60 | 0.008 | 0.016 | 0.024 |
| HE | 2.50 | 2.80 | 3.00 | 0.099 | 0.110 | 0.118 |

- STYLE 1:
PIN 1. BASE
2. EMITTER
3. COLLECTOR

SOLDERING FOOTPRINT*

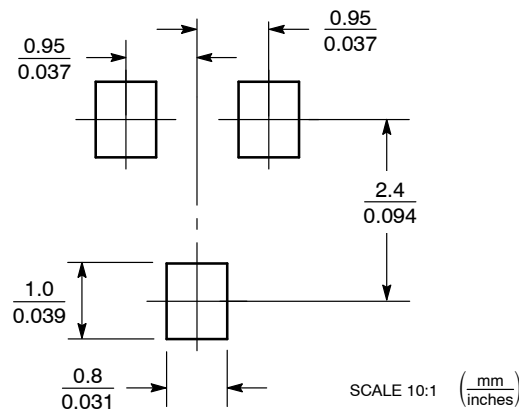

*For additional information on our Pb-Free strategy and soldering details, please download the ON Semiconductor Soldering and Mounting Techniques Reference Manual, SOLDERRM/D.

PACKAGE DIMENSIONS

SOT-23 (TO-236)
CASE 318-08
ISSUE AR

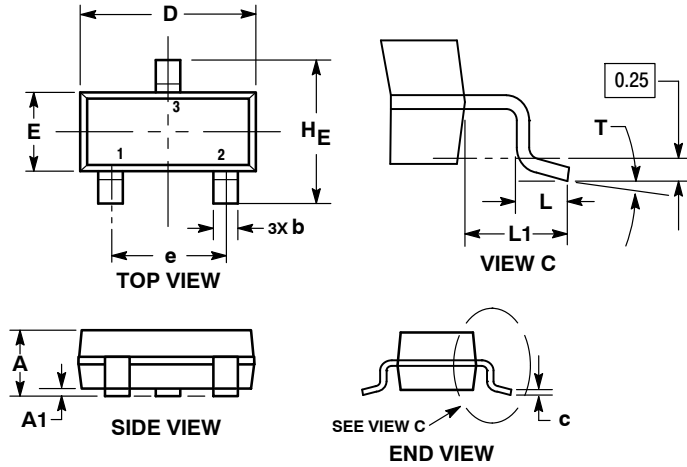

NOTES:

1. DIMENSIONING AND TOLERANCING PER ASME Y14.5M, 1994.
2. CONTROLLING DIMENSION: MILLIMETERS.
3. MAXIMUM LEAD THICKNESS INCLUDES LEAD FINISH. MINIMUM LEAD THICKNESS IS THE MINIMUM THICKNESS OF THE BASE MATERIAL.
4. DIMENSIONS D AND E DO NOT INCLUDE MOLD FLASH, PROTRUSIONS, OR GATE BURRS.

| DIM | MILLIMETERS | | | INCHES | | |
|-----|-------------|------|------|--------|-------|-------|
| | MIN | NOM | MAX | MIN | NOM | MAX |
| A | 0.89 | 1.00 | 1.11 | 0.035 | 0.039 | 0.044 |
| A1 | 0.01 | 0.06 | 0.10 | 0.000 | 0.002 | 0.004 |
| b | 0.37 | 0.44 | 0.50 | 0.015 | 0.017 | 0.020 |
| c | 0.08 | 0.14 | 0.20 | 0.003 | 0.006 | 0.008 |
| D | 2.80 | 2.90 | 3.04 | 0.110 | 0.114 | 0.120 |
| E | 1.20 | 1.30 | 1.40 | 0.047 | 0.051 | 0.055 |
| e | 1.78 | 1.90 | 2.04 | 0.070 | 0.075 | 0.080 |
| L | 0.30 | 0.43 | 0.55 | 0.012 | 0.017 | 0.022 |
| L1 | 0.35 | 0.54 | 0.69 | 0.014 | 0.021 | 0.027 |
| HE | 2.10 | 2.40 | 2.64 | 0.083 | 0.094 | 0.104 |
| T | 0° | --- | 10° | 0° | --- | 10° |

STYLE 6:

1. BASE
2. EMITTER
3. COLLECTOR

RECOMMENDED
SOLDERING FOOTPRINT*

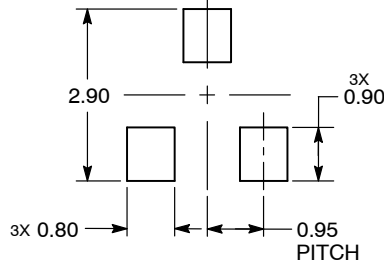

DIMENSIONS: MILLIMETERS

*For additional information on our Pb-Free strategy and soldering details, please download the ON Semiconductor Soldering and Mounting Techniques Reference Manual, SOLDERRM/D.

PACKAGE DIMENSIONS

SC-70 (SOT-323)
CASE 419-04
ISSUE N

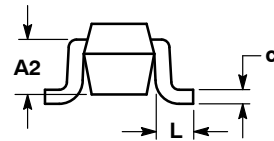
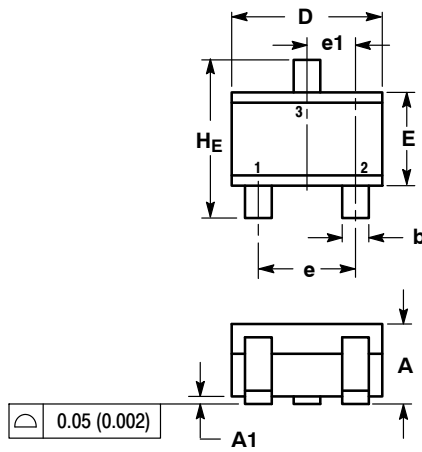

NOTES:

1. DIMENSIONING AND TOLERANCING PER ANSI Y14.5M, 1982.
2. CONTROLLING DIMENSION: INCH.

| DIM | MILLIMETERS | | | INCHES | | |
|-----|-------------|------|------|-----------|-------|-------|
| | MIN | NOM | MAX | MIN | NOM | MAX |
| A | 0.80 | 0.90 | 1.00 | 0.032 | 0.035 | 0.040 |
| A1 | 0.00 | 0.05 | 0.10 | 0.000 | 0.002 | 0.004 |
| A2 | 0.70 REF | | | 0.028 REF | | |
| b | 0.30 | 0.35 | 0.40 | 0.012 | 0.014 | 0.016 |
| c | 0.10 | 0.18 | 0.25 | 0.004 | 0.007 | 0.010 |
| D | 1.80 | 2.10 | 2.20 | 0.071 | 0.083 | 0.087 |
| E | 1.15 | 1.24 | 1.35 | 0.045 | 0.049 | 0.053 |
| e | 1.20 | 1.30 | 1.40 | 0.047 | 0.051 | 0.055 |
| e1 | 0.65 BSC | | | 0.026 BSC | | |
| L | 0.20 | 0.38 | 0.56 | 0.008 | 0.015 | 0.022 |
| HE | 2.00 | 2.10 | 2.40 | 0.079 | 0.083 | 0.095 |

STYLE 3:
PIN 1. BASE
2. EMITTER
3. COLLECTOR

SOLDERING FOOTPRINT*

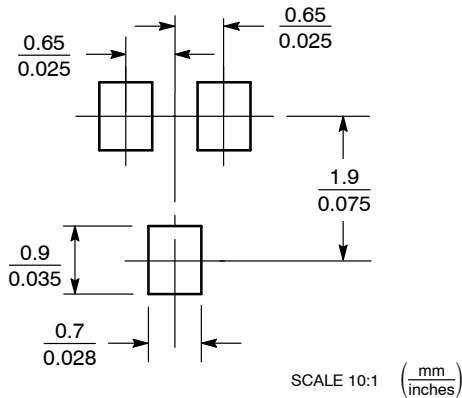

*For additional information on our Pb-Free strategy and soldering details, please download the ON Semiconductor Soldering and Mounting Techniques Reference Manual, SOLDERRM/D.

PACKAGE DIMENSIONS

SC-75/SOT-416
CASE 463
ISSUE G

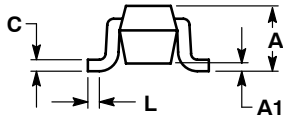
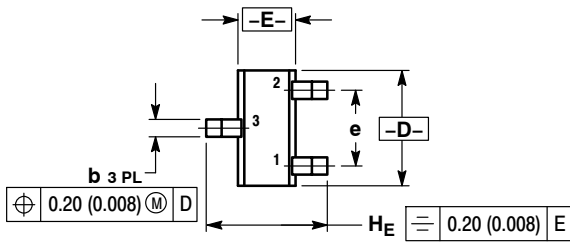

- NOTES:
1. DIMENSIONING AND TOLERANCING PER ANSI Y14.5M, 1982.
2. CONTROLLING DIMENSION: MILLIMETER.

| DIM | MILLIMETERS | | | INCHES | | |
|----------------|-------------|------|------|----------|-------|-------|
| | MIN | NOM | MAX | MIN | NOM | MAX |
| A | 0.70 | 0.80 | 0.90 | 0.027 | 0.031 | 0.035 |
| A1 | 0.00 | 0.05 | 0.10 | 0.000 | 0.002 | 0.004 |
| b | 0.15 | 0.20 | 0.30 | 0.006 | 0.008 | 0.012 |
| C | 0.10 | 0.15 | 0.25 | 0.004 | 0.006 | 0.010 |
| D | 1.55 | 1.60 | 1.65 | 0.059 | 0.063 | 0.067 |
| E | 0.70 | 0.80 | 0.90 | 0.027 | 0.031 | 0.035 |
| e | 1.00 BSC | | | 0.04 BSC | | |
| L | 0.10 | 0.15 | 0.20 | 0.004 | 0.006 | 0.008 |
| H _E | 1.50 | 1.60 | 1.70 | 0.061 | 0.063 | 0.065 |

- STYLE 1:
PIN 1. BASE
2. EMITTER
3. COLLECTOR

SOLDERING FOOTPRINT*

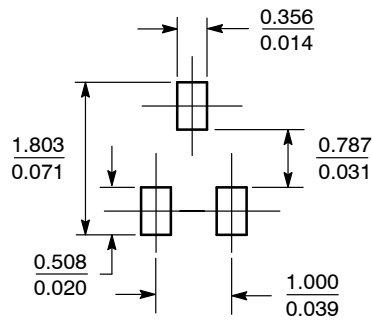

SCALE 10:1 (mm/inches)

*For additional information on our Pb-Free strategy and soldering details, please download the ON Semiconductor Soldering and Mounting Techniques Reference Manual, SOLDERRM/D.

PACKAGE DIMENSIONS

SOT-723
CASE 631AA
ISSUE D

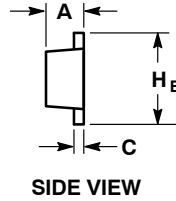
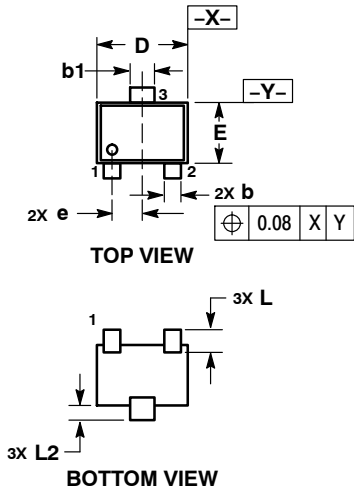

NOTES:

1. DIMENSIONING AND TOLERANCING PER ASME Y14.5M, 1994.
2. CONTROLLING DIMENSION: MILLIMETERS.
3. MAXIMUM LEAD THICKNESS INCLUDES LEAD FINISH. MINIMUM LEAD THICKNESS IS THE MINIMUM THICKNESS OF BASE MATERIAL.
4. DIMENSIONS D AND E DO NOT INCLUDE MOLD FLASH, PROTRUSIONS OR GATE BURRS.

| DIM | MILLIMETERS | | |
|-----|-------------|------|------|
| | MIN | NOM | MAX |
| A | 0.45 | 0.50 | 0.55 |
| b | 0.15 | 0.21 | 0.27 |
| b1 | 0.25 | 0.31 | 0.37 |
| C | 0.07 | 0.12 | 0.17 |
| D | 1.15 | 1.20 | 1.25 |
| E | 0.75 | 0.80 | 0.85 |
| e | 0.40 BSC | | |
| H E | 1.15 | 1.20 | 1.25 |
| L | 0.29 REF | | |
| L2 | 0.15 | 0.20 | 0.25 |

STYLE 1:

1. BASE
2. EMITTER
3. COLLECTOR

RECOMMENDED
SOLDERING FOOTPRINT*

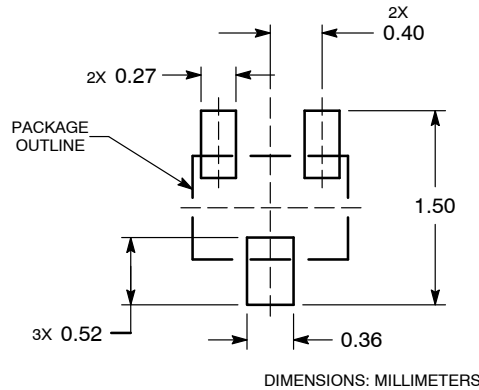

*For additional information on our Pb-Free strategy and soldering details, please download the ON Semiconductor Soldering and Mounting Techniques Reference Manual, SOLDERRM/D.

PACKAGE DIMENSIONS

SOT-1123
CASE 524AA
ISSUE C

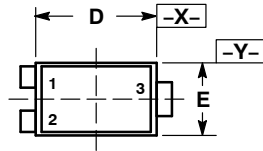

TOP VIEW

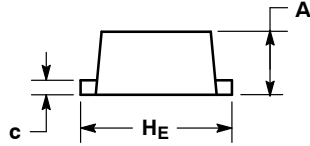

SIDE VIEW

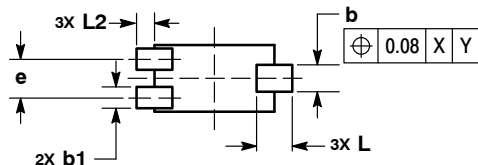

BOTTOM VIEW

NOTES:

1. DIMENSIONING AND TOLERANCING PER ASME Y14.5M, 1994.
2. CONTROLLING DIMENSION: MILLIMETERS.
3. MAXIMUM LEAD THICKNESS INCLUDES LEAD FINISH. MINIMUM LEAD THICKNESS IS THE MINIMUM THICKNESS OF BASE MATERIAL.
4. DIMENSIONS D AND E DO NOT INCLUDE MOLD FLASH, PROTRUSIONS, OR GATE BURRS.

| MILLIMETERS | | |
|----------------|-------|------|
| DIM | MIN | MAX |
| A | 0.34 | 0.40 |
| b | 0.15 | 0.28 |
| b1 | 0.10 | 0.20 |
| c | 0.07 | 0.17 |
| D | 0.75 | 0.85 |
| E | 0.55 | 0.65 |
| e | 0.35 | 0.40 |
| H _E | 0.95 | 1.05 |
| L | 0.185 | REF |
| L2 | 0.05 | 0.15 |

STYLE 1:

1. BASE
2. EMITTER
3. COLLECTOR

SOLDERING FOOTPRINT*

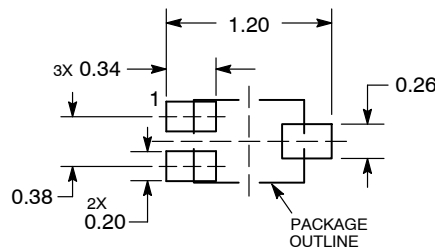

DIMENSIONS: MILLIMETERS

*For additional information on our Pb-Free strategy and soldering details, please download the ON Semiconductor Soldering and Mounting Techniques Reference Manual, SOLDERRM/D.

ON Semiconductor and are trademarks of Semiconductor Components Industries, LLC dba ON Semiconductor or its subsidiaries in the United States and/or other countries. ON Semiconductor owns the rights to a number of patents, trademarks, copyrights, trade secrets, and other intellectual property. A listing of ON Semiconductor's product/patent coverage may be accessed at www.onsemi.com/site/pdf/Patent-Marking.pdf. ON Semiconductor reserves the right to make changes without further notice to any products herein. ON Semiconductor makes no warranty, representation or guarantee regarding the suitability of its products for any particular purpose, nor does ON Semiconductor assume any liability arising out of the application or use of any product or circuit, and specifically disclaims any and all liability, including without limitation special, consequential or incidental damages. Buyer is responsible for its products and applications using ON Semiconductor products, including compliance with all laws, regulations and safety requirements or standards, regardless of any support or applications information provided by ON Semiconductor. "Typical" parameters which may be provided in ON Semiconductor data sheets and/or specifications can and do vary in different applications and actual performance may vary over time. All operating parameters, including "Typicals" must be validated for each customer application by customer's technical experts. ON Semiconductor does not convey any license under its patent rights nor the rights of others. ON Semiconductor products are not designed, intended, or authorized for use as a critical component in life support systems or any FDA Class 3 medical devices or medical devices with a same or similar classification in a foreign jurisdiction or any devices intended for implantation in the human body. Should Buyer purchase or use ON Semiconductor products for any such unintended or unauthorized application, Buyer shall indemnify and hold ON Semiconductor and its officers, employees, subsidiaries, affiliates, and distributors harmless against all claims, costs, damages, and expenses, and reasonable attorney fees arising out of, directly or indirectly, any claim of personal injury or death associated with such unintended or unauthorized use, even if such claim alleges that ON Semiconductor was negligent regarding the design or manufacture of the part. ON Semiconductor is an Equal Opportunity/Affirmative Action Employer. This literature is subject to all applicable copyright laws and is not for resale in any manner.

PUBLICATION ORDERING INFORMATION

LITERATURE FULFILLMENT:
Literature Distribution Center for ON Semiconductor
19521 E. 32nd Pkwy, Aurora, Colorado 80011 USA
Phone: 303-675-2175 or 800-344-3860 Toll Free USA/Canada
Fax: 303-675-2176 or 800-344-3867 Toll Free USA/Canada
Email: orderlit@onsemi.com

N. American Technical Support: 800-282-9855 Toll Free
USA/Canada
Europe, Middle East and Africa Technical Support:
Phone: 421 33 790 2910
Japan Customer Focus Center
Phone: 81-3-5817-1050

ON Semiconductor Website: www.onsemi.com
Order Literature: <http://www.onsemi.com/orderlit>
For additional information, please contact your local Sales Representative