

APREPARED BY : DATE	SHARP DISPLAY DEVICE BUSINESS GROUP SHARP CORPORATION SPECIFICATION	SPEC No. LD-24701A
APPROVED BY : DATE		FILE No.
		ISSUE : Aug. 27, 2012
		PAGE : 19 pages
		APPLICABLE GROUP DISPLAY DEVICE BUSINESS GROUP

DEVICE SPECIFICATION FOR
TFT-LCD Module
 MODEL No.
LQ090Y3DG01

CUSTOMER'S APPROVAL

DATE _____

BY _____

PRESENTED

BY *J. Kawanishi*

J. KAWANISHI
 Department General Manager
 Development Dept. I
 DISPLAY DEVICE DIVISION II
 DISPLAY DEVICE BUSINESS GROUP
 SHARP CORPORATION

Table of contents

1. Application	1
2. Overview	2
3. Mechanical Specifications	2
4. Input Terminals	3
4-1. TFT-LCD panel driving	3
4-2 Interface block diagram	4
5. Absolute Maximum Ratings.	4
6. Electrical Characteristics	5
6-1.TFT-LCD panel driving.	5
6-2.Backlight driving	7
7. Timing Characteristics of Input Signals.	8
7-1. Timing characteristics.	8
7-2. Input data signals and display position on the screen	8
8. Input Signals, Basic Display Colors and Gray Scale of Each Color	9
9. Optical Characteristics	10
10. Handling Precautions	12
11. Packing form	13
12. Reliability test items	14
13. Others.	14
14. Storage conditions	15
Fig.1 Outline Dimensions	16
Fig.2 Packing form.	17

1. Application

This specification applies to a color TFT-LCD module, LQ090Y3DG01

These specification sheets are the proprietary product of SHARP CORPORATION ("SHARP") and include materials protected under copyright of SHARP. Do not reproduce or cause any third party to reproduce them in any form or by any means, electronic or mechanical, for any purpose, in whole or in part, without the express written permission of SHARP.

In case of using the device for applications such as control and safety equipment for transportation (aircraft, trains, automobiles, etc.), rescue and security equipment and various safety related equipment which require higher reliability and safety, take into consideration that appropriate measures such as fail-safe functions and redundant system design should be taken.

Do not use the device for equipment that requires an extreme level of reliability, such as aerospace applications, telecommunication equipment (trunk lines), nuclear power control equipment and medical or other equipment for life support.

SHARP assumes no responsibility for any damage resulting from the use of the device, which does not comply with the instructions, and the precautions specified in these specification sheets.

Contact and consult with a SHARP sales representative for any questions about this device.

2. Overview

This module is a color active matrix LCD module incorporating amorphous silicon TFT (Thin Film Transistor). It is composed of a color TFT-LCD panel, driver ICs, and a backlight unit.

Graphics and texts can be displayed on an 800×RGB×480 dots panel with 16,777,216 colors by using 24bit digital signal interface (RGB×8bit) and DC supply voltage for TFT-LCD panel driving and supply voltage for backlight.

In this TFT-LCD panel, low reflection / color filters of excellent color performance and backlights of high brightness are incorporated to realize brighter and clearer pictures, making this model optimum for use in multi-media applications.

6 o'clock direction: Large contrast direction.

12 o'clock direction: Hard to gray scale inversion.

Backlight-driving DC/DC converter is built in this module.

3. Mechanical Specifications

Parameter	Specifications	Unit
Display size	22.9 (9.0") Diagonal	cm
Active area	198.0 (H)×111.7 (V)	mm
Pixel format	800 (H)×480 (V)	pixel
	(1 pixel = R+G+B dots)	
Aspect ratio (Dimension)	16:9	
Pixel pitch	0.2475 (H)×0.2327 (V)	mm
Pixel configuration	R,G,B Vertical stripe	
Display mode	Normally white	
Unit outline dimensions [Note 1]	211.1(W) x 128.4(H) x 6.6(D)	mm
Mass (Typ.)	255	g
Surface treatment	Anti Glare and hard-coating 3H	

[Note 1] Outline dimensions is shown in Fig.1

4. Input Terminals

4-1. TFT-LCD panel driving

Using connector: 089H50-000000-G2-R (Starconn)

Pin No.	Symbol	Function	Remark
1	GND	Ground	
2	GND	Ground	
3	VDD	LCD Power Supply	
4	VDD	LCD Power Supply	
5	U/D	Vertical display mode select signal	[Note 4-3]
6	L/R	Horizontal display mode select signal	[Note 4-3]
7	GND	Ground	
8	R0	Red data input (LSB)	[Note 4-1]
9	R1	Red data input	[Note 4-1]
10	R2	Red data input	
11	R3	Red data input	
12	GND	Ground	
13	R4	Red data input	
14	R5	Red data input	
15	GND	Ground	
16	R6	Red data input	
17	R7	Red data input (MSB)	
18	GND	Ground	
19	G0	Green data input (LSB)	[Note 4-1]
20	G1	Green data input	[Note 4-1]
21	G2	Green data input	
22	G3	Green data input	
23	GND	Ground	
24	G4	Green Data input	
25	G5	Green data input	
26	GND	Ground	
27	G6	Green data input	
28	G7	Green data input (MSB)	
29	GND	Ground	
30	B0	Blue data input (LSB)	[Note 4-1]
31	B1	Blue data input	[Note 4-1]
32	B2	Blue data input	
33	B3	Blue data input	
34	GND	Ground	
35	B4	Blue data input	
36	B5	Blue data input	
37	GND	Ground	
38	B6	Blue data input	
39	B7	Blue data input (MSB)	
40	GND	Ground	
41	DCLK	Clock signal for sampling each data signal	[Note 4-2]
42	GND	Ground	
43	DE	Data Enable Signal	
44	TEST	Please fix "Low".	
45	GND	Ground	
46	GND	Ground	
47	LED_PWM	LED PWM Signal	
48	LED_EN	LED Enable Signal	High Enable
49	VLED	LED Power	
50	VLED	LED Power	

[Note 4-1] When input 18 bits RGB data, this terminals must be "Low" level.

[Note 4-2] Data shall be latch at falling edgh of DCLK.

[Note 4-3]

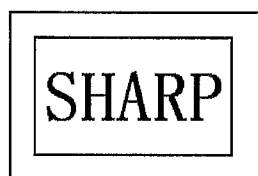

R/L=High, U/D=Low

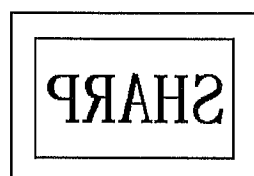

R/L=Low, U/D=Low

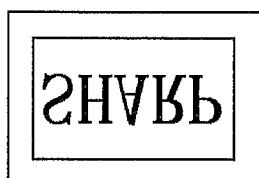

R/L=High, U/D=High

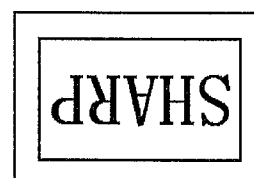

R/L=Low, U/D=Low

4-2 Interface block diagram

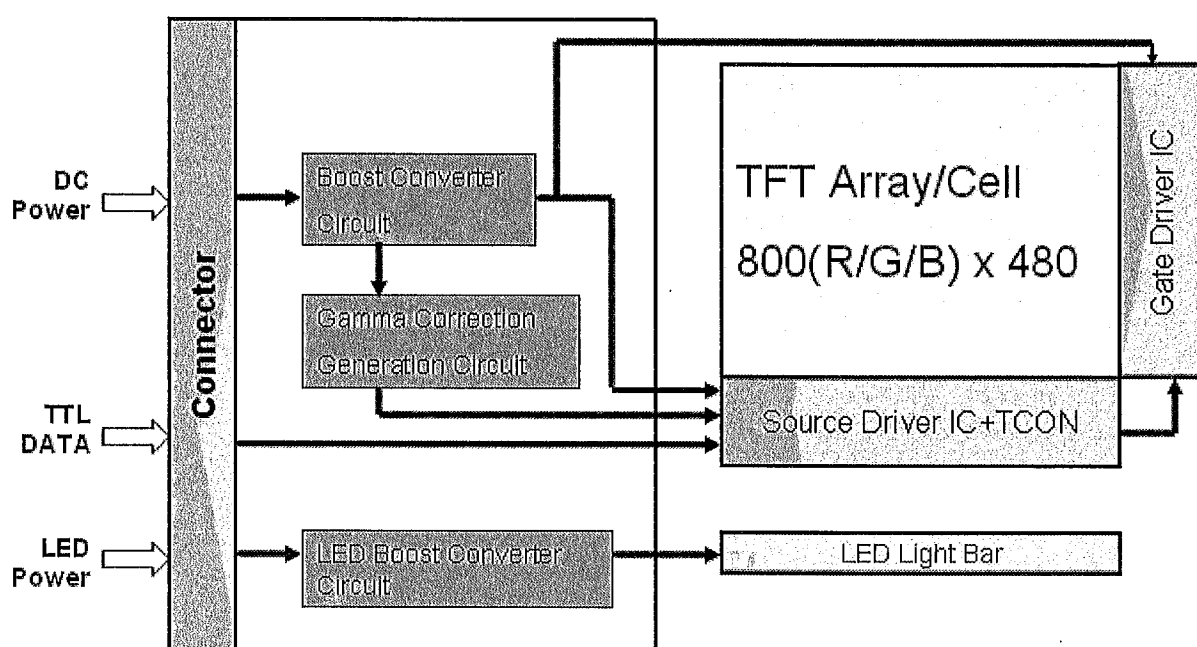

5. Absolute Maximum Ratings

Parameter	Symbol	Condition	Ratings		Unit	Remark
			Min.	Max.		
Input voltage	VDD	Ta=25°C	-0.3	4.0	V	[Note 3]
LED reverse voltage	VLED	Ta=25°C	-0.3	22.0	V	[Note 3]
Input voltage	VI1	Ta=25°C	-0.3	4.0	V	[Note 3,4]
	VI2	Ta=25°C	-0.3	6.0	V	[Note 3,5]
Storage temperature	Tstg	-	-30	+80	°C	[Note 1,2,6]
Operating temperature	Topa	-	-20	+75	°C	[Note 1,2,6]

[Note 1] Humidity: 90%RH Max. (at Ta=<40°C)

Maximum wet-bulb temperature at 39°C or less (at Ta>40°C)

Dew condensation must be avoided as electrical current leaks will occur, causing a degradation of performance specifications.

[Note 2] The operating temperature guarantees only operation of the circuit.

For contrast, response time and other factors related to display quality, judgment is done using the ambient temperature $T_a=+25^{\circ}\text{C}$.

[Note 3] Permanent damage may occur to the LCD module if beyond this specification. Functional operation should be restricted to the conditions described under normal operating conditions.

[Note 4] R0~R7, G0~G7, B0~B7, DCLK, DE, U/D, L/R, Do not use over $V_{DD}+0.3\text{V}$.

[Note 5] LED_PWM, LED_EN, Do not use over $V_{DD}+0.3\text{V}$.

[Note 6] Permanent damage may occur to the LCD module if beyond this specification.

Functional operation and LCD storage should be restricted to the conditions described under normal temperature (LCD outside).

6. Electrical Characteristics

6-1.TFT-LCD panel driving

$T_a=25^{\circ}\text{C}$

Parameter	Symbol	Condition	Min.	Typ.	Max.	Unit	Remark
Supply voltage	V_{DD}		3.0	3.3	3.6	V	[Note 2]
Input voltage range	I_{DD}	$V_{DD}=3.3\text{V}$	—	100	210	mA	Black pattern 60Hz
Power consumption	P_{DD}		—	—	0.7	W	
Rush current	I_{rush}		—	—	1.5	A	[Note 3]
Permissive input ripple voltage	V_{RP}		—	—	100	mV _{P-P}	$V_{DD}=3.3\text{V}$
Input voltage range	V_{IH}	“High”	$0.7V_{DD}$	—	V_{DD}	V	[Note 1]
Input voltage range	V_{IL}	“Low”	0	—	$0.3V_{DD}$	V	
Input leak current	I_{OH}	$V_I=2.4\text{V}$ $V_{DD}=3.3\text{V}$	—	—	400	μA	[Note 1]
Input leak current	I_{OL}	$V_{I2}=0\text{V}$	-10	—	+10	μA	

[Note 1] R0~R7, G0~G7, B0~B7, DE, DCLK, L/R, U/D

[Note 2]

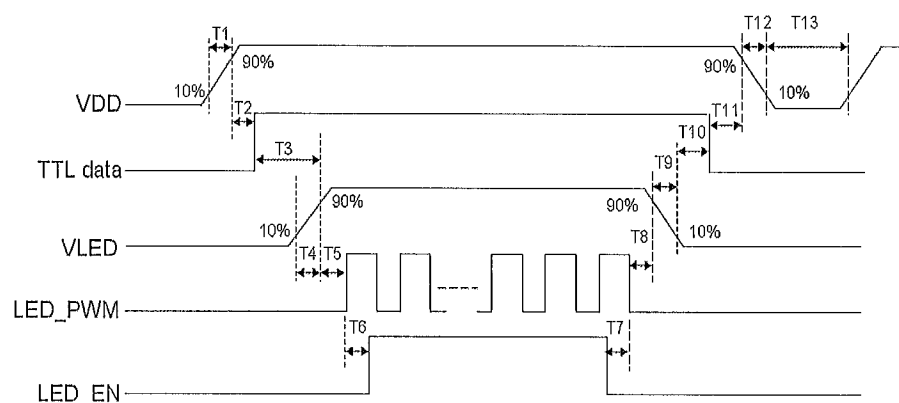

Symbol	Min.	Typ.	Max.	Unit
T1	0.5	-	10	ms
T2	30	-	90	ms
T3	200	-	-	ms
T4	0.5	-	-	ms
T5	10	-	-	ms
T6	10	-	-	ms
T7	0	-	-	ms
T8	10	-	-	ms
T9	-	10	30	ms
T10	200	-	-	ms
T11	0	-	50	ms
T12	-	10	30	ms
T13	500	-	-	ms

*TTL_DATA: R0~R7, G0~G7, B0~B7, DE, DCLK, L/R, U/D

- This LCD is driven only by DE signal. Hsync/Vsync does not need to input.
- As for the power sequence for backlight, it is recommended to apply above mentioned input timing. If the backlight is lit on and off at a timing other than shown above, displaying image may get disturbed.
- Please advise a power supply ON period that an input signal is not set to High-Z or it does not input an unusual signal.

[Note 3] LCD rush current measurement condition

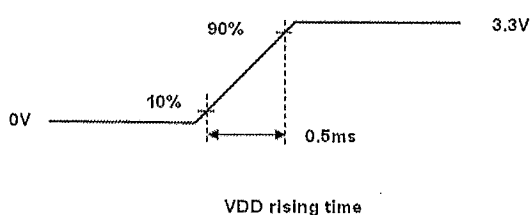

[Note 4] VDD power dip condition

$$1) V_{th} < V_{CC} \leq V_{min}$$

$$t_d \leq 10ms$$

Under above condition, the display image should return to an appropriate figure after Vcc voltage recovers.

$$2) V_{CC} < V_{th}$$

Vcc-dip conditions should also follow the

On-off conditions for supply voltage.

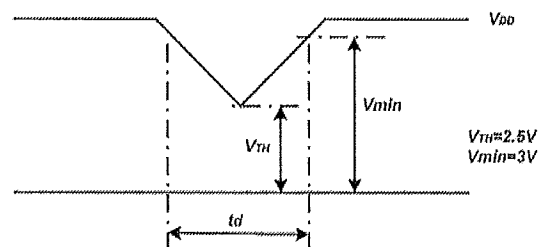

6-2.Backlight driving

It is usually required to measure under the following condition.

$T_a=25^{\circ}\text{C}\pm 2^{\circ}\text{C}$

Parameter		Symbol	Min.	Typ.	Max.	Unit	Remarks	
Supply voltage		V_{DD}	4.5	12.0	21.0	V	[Note2] (see.page 7)	
Power consumption		I_{DD}	-	-	2.1	W		
Permissive input ripple voltage		V_{RP_BL}	-	-	100	mVp-p	$V_L=+12.0\text{V}$	
Rush current		I_{Lrush}	-	-	2.0	A	[Note10]	
Input voltage	High	V_{LIH_BL}	2.5	-	5.5	V	[Note5]	
	Low	V_{LIL_BL}	0	-	0.5	V		
Input leak current	High	I_{LIH_BL}	-	-	800	μA	$V_L=2.5\text{V}$	[Note6]
			+10	μA	$V_L=12\text{V}$	[Note7]		
	Low	I_{LIL_BL}	-10	-	+10	μA	$V_L=0\text{V}$ $V_L=12\text{V}$ [Note5]	
PWM frequency	F_{PWM}	100	-	1,000	Hz	Ddim>=1% [Note8]		
		100	-	5,000	Hz	Ddim>=5% [Note8]		
Life time	LT	20000	-	-	h	Reference value [Note9]		

[Note 5] LED_PWM、LED_EN

[Note 6] LED_PWM

[Note 7] LED_EN

[Note 8] PWM Signal

$$F_{PWM} = 1/t_{15}$$

Duty 1% (at $F_{PWM} \leq 1000\text{Hz}$) : Min. Luminance

Duty 100% : Max. Luminance

Luminance changes in proportion to the duty ratio.

• Please advise PWM terminal is not set to High-Z.

• When the frequency slows, the display fineness might decrease.

[Note 9] Luminance becomes 50% of an initial value. ($T_a=25^{\circ}\text{C}$, PWM=100%)

[Note 10] LED rush current measure condition

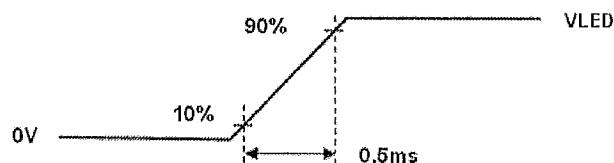
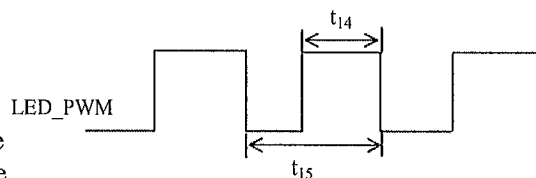

VLED rising time

7. Timing Characteristics of Input Signals

7-1. Timing characteristics

Characteristics		Symbol	Min.	Typ.	Max.	Unit	Remark	
DOTCLK	Frequency	$1/T_C$	28.0	30.0	35.0	MHz		
	High Width	T_{cH}	10	—	—	ns		
	Low Width	T_{cL}	10	—	—	ns		
	Duty ratio	T_{cH}/T_C	40	50	60	%		
DATA	Setup Time	T_{ds}	8	—	—	ns		
	Hold Time	T_{dh}	8	—	—	ns		
ENAB	Horizontal	Period	T_H	908	928	1080	Clock	
		Display Area	T_{HD}	800	800	800	Clock	
		Period	T_V	517	525	704	Line	[Note1]
	Vertical	Display Area	T_{VP}	480	480	480	Line	
		Setup time	T_{ES}	8	-	-	ns	
		Hold time	T_{EH}	8	-	-	ns	

[Note1] In case of lower frequency, the deterioration of display quality, flicker etc., may be occurred.

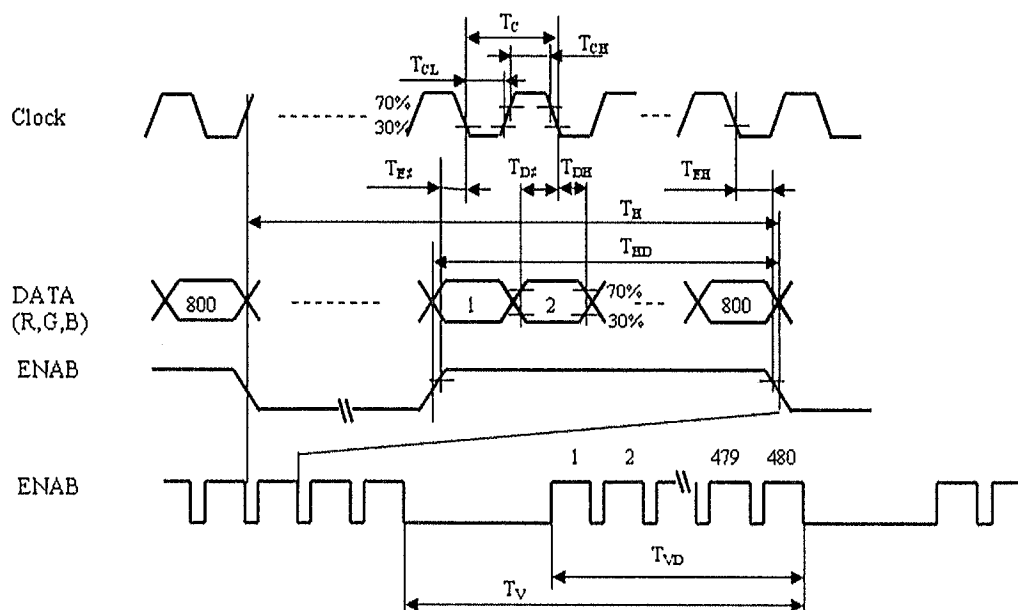

7-2. Input data signals and display position on the screen

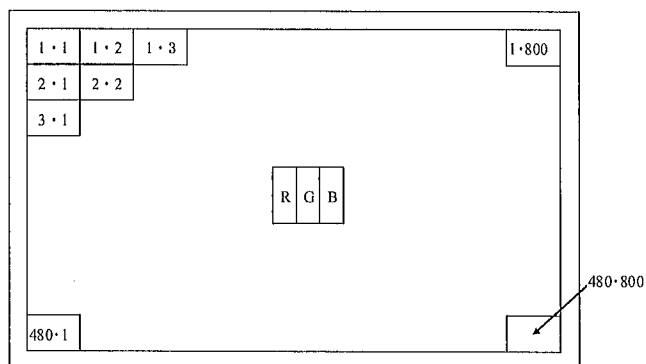

Display position of input data(V · H)

8. Input Signals, Basic Display Colors and Gray Scale of Each Color

	Colors & Gray scale	Data signal																								
		Gray Scale	R0	R1	R2	R3	R4	R5	R6	R7	G0	G1	G2	G3	G4	G5	G6	G7	B0	B1	B2	B3	B4	B5	B6	B7
	Black	—	0	0	0	0	0	0	0	0	0	0	0	0	0	0	0	0	0	0	0	0	0	0	0	0
	Blue	—	0	0	0	0	0	0	0	0	0	0	0	0	0	0	0	0	1	1	1	1	1	1	1	1
	Green	—	0	0	0	0	0	0	0	0	1	1	1	1	1	1	1	1	0	0	0	0	0	0	0	0
	Cyan	—	0	0	0	0	0	0	0	0	1	1	1	1	1	1	1	1	1	1	1	1	1	1	1	1
	Red	—	1	1	1	1	1	1	1	1	0	0	0	0	0	0	0	0	0	0	0	0	0	0	0	0
	Magenta	—	1	1	1	1	1	1	1	1	0	0	0	0	0	0	0	0	1	1	1	1	1	1	1	1
	Yellow	—	1	1	1	1	1	1	1	1	1	1	1	1	1	1	1	1	0	0	0	0	0	0	0	0
	White	—	1	1	1	1	1	1	1	1	1	1	1	1	1	1	1	1	1	1	1	1	1	1	1	1
Gray Scale of Red	Black	GS0	0	0	0	0	0	0	0	0	0	0	0	0	0	0	0	0	0	0	0	0	0	0	0	0
	↑	GS1	1	0	0	0	0	0	0	0	0	0	0	0	0	0	0	0	0	0	0	0	0	0	0	0
	Darker	GS2	0	1	0	0	0	0	0	0	0	0	0	0	0	0	0	0	0	0	0	0	0	0	0	0
	↑	↓					↓							↓								↓				
	↓	↓					↓							↓								↓				
	Brighter	GS253	1	0	1	1	1	1	1	1	0	0	0	0	0	0	0	0	0	0	0	0	0	0	0	0
	↓	GS254	0	1	1	1	1	1	1	1	0	0	0	0	0	0	0	0	0	0	0	0	0	0	0	0
	Red	GS255	1	1	1	1	1	1	1	1	0	0	0	0	0	0	0	0	0	0	0	0	0	0	0	0
Gray Scale of Green	Black	GS0	0	0	0	0	0	0	0	0	0	0	0	0	0	0	0	0	0	0	0	0	0	0	0	0
	↑	GS1	0	0	0	0	0	0	0	0	1	0	0	0	0	0	0	0	0	0	0	0	0	0	0	0
	Darker	GS2	0	0	0	0	0	0	0	0	0	1	0	0	0	0	0	0	0	0	0	0	0	0	0	0
	↑	↓					↓							↓								↓				
	↓	↓					↓							↓								↓				
	Brighter	GS253	0	0	0	0	0	0	0	0	1	0	1	1	1	1	1	1	0	0	0	0	0	0	0	0
	↓	GS254	0	0	0	0	0	0	0	0	0	1	1	1	1	1	1	1	0	0	0	0	0	0	0	0
	Green	GS255	0	0	0	0	0	0	0	0	1	1	1	1	1	1	1	1	0	0	0	0	0	0	0	0
Gray Scale of Blue	Black	GS0	0	0	0	0	0	0	0	0	0	0	0	0	0	0	0	0	0	0	0	0	0	0	0	0
	↑	GS1	0	0	0	0	0	0	0	0	0	0	0	0	0	0	0	0	1	0	0	0	0	0	0	0
	Darker	GS2	0	0	0	0	0	0	0	0	0	0	0	0	0	0	0	0	0	1	0	0	0	0	0	0
	↑	↓					↓							↓								↓				
	↓	↓					↓							↓								↓				
	Brighter	GS253	0	0	0	0	0	0	0	0	0	0	0	0	0	0	0	0	1	0	1	1	1	1	1	1
	↓	GS254	0	0	0	0	0	0	0	0	0	0	0	0	0	0	0	0	0	1	1	1	1	1	1	1
	Blue	GS255	0	0	0	0	0	0	0	0	0	0	0	0	0	0	0	0	1	1	1	1	1	1	1	1

0 : Low level voltage, 1 : High level voltage.

Each basic color can be displayed in 256 gray scales from 8 bit data signals. According to the combination of total 24 bit data signals, the 16 million-color display can be achieved on the screen.

9. Optical Characteristics

Ta=+25°C, Vcc=+3.3V

Parameter		Symbol	Condition	Min.	Typ.	Max.	Unit	Remark
Viewing angle range	Horizontal	$\theta 21, \theta 22$	CR>10	60	70	—	Deg.	[Note 1,4]
	Vertical	$\theta 11$		40	50	—	Deg.	
		$\theta 12$		60	70	—	Deg.	
Contrast ratio		CRn	$\theta = 0^\circ$	400	500	—		[Note 2,4]
Response time		$\tau r + \tau d$		—	25	50	ms	[Note 3,4]
Chromaticity of white		x		0.260	0.310	0.360		[Note 4]
		y		0.280	0.330	0.380		
Luminance of white		Y_{L1}		200	300	—	cd/m ²	
White Uniformity		δw				1.43		[Note 5]

※ The measurement shall be executed 30 minutes after lighting at rating. Condition : Ddim=100%

The optical characteristics shall be measured in a dark room or equivalent.

[Measuring Viewing Angle Range]

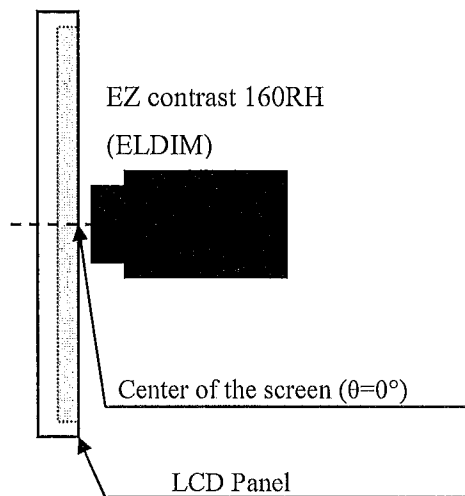

[Other Measurements]

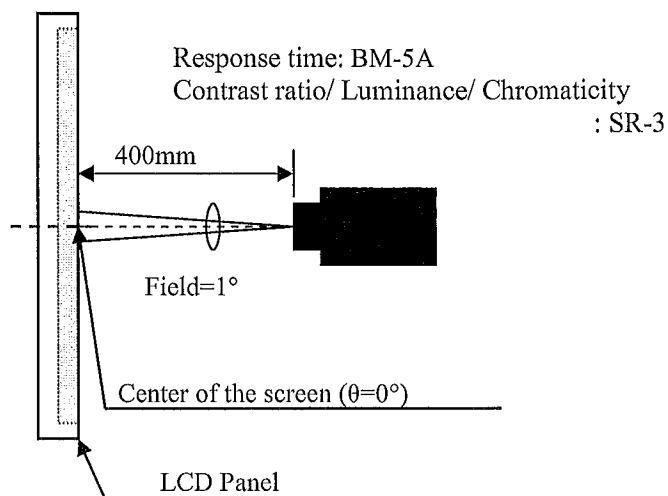

[Note 1] Definitions of viewing angle range:

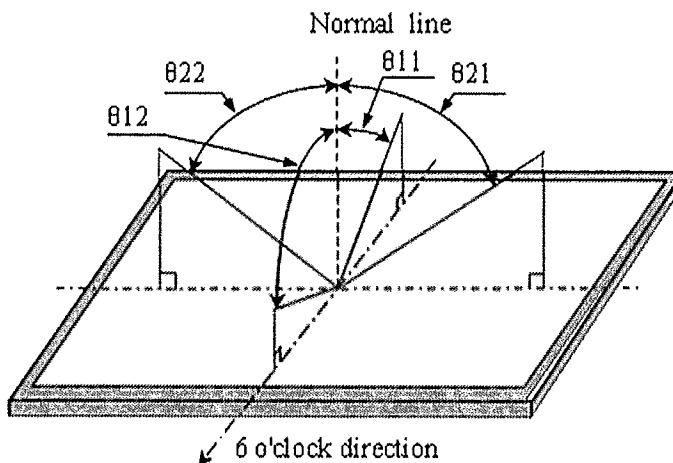

[Note 2] Definition of contrast ratio:

The contrast ratio is defined as the following.

$$\text{Contrast Ratio (CR)} = \frac{\text{Luminance (brightness) with all pixels white}}{\text{Luminance (brightness) with all pixels black}}$$

[Note 3] Definition of response time:

The response time is defined as the following figure and shall be measured by switching the input signal for "black" and "white".

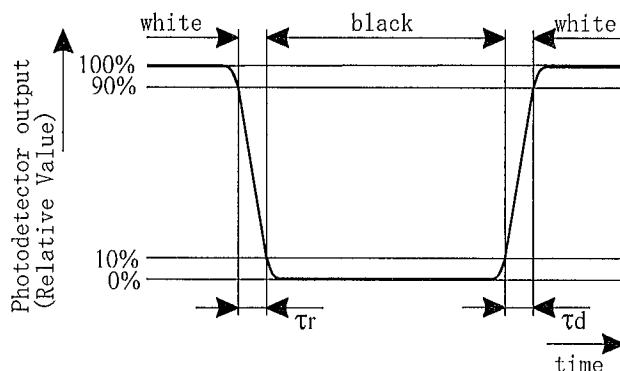

[Note 4] This shall be measured at center of the screen.

[Note 5] Definition of white uniformity

White uniformity is defined as the following with five measurements.

$$\delta_w = \frac{\text{Maximum luminance of 5 points (1-5)}}{\text{Minimum luminance of 5 points (1-5)}}$$

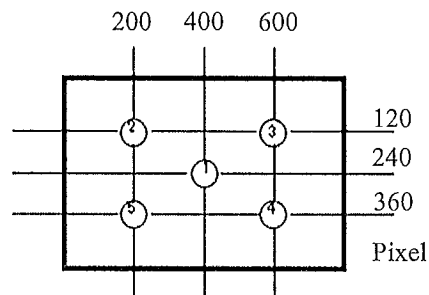

10. Handling Precautions

【Precautions of handling】	
a)	Treat LCD module in dustless surroundings. Metal foreign material stuck to the circuit is possible to cause a short.
b)	Be sure to turn off the power supply when inserting or disconnecting the cable.
c)	Be careful not to give any physical stress onto the circuit and/or the connector of LCD module when you pull/plug a cable. Physical stress will cause a break or worse connection.
d)	Since the front polarizer is easily damaged, pay attention not to scratch it.
e)	Use N2-blower such as an ionized nitrogen has anti-electrostatic when you blow dusts on Polarizer.
f)	Since a long contact with water may cause discoloration or spots, wipe it with absorbent cotton or other soft cloth immediately.
g)	Since CMOS LSI is used in this module, take care of static electricity and injure the human earth when handling. Observe all other precautionary requirements in handling components.
h)	Be careful with the edge parts of the module which is made of metal.
i)	Since the panel is made of glass, it may break or crack if dropped or bumped on hard surface. Handle with care.
j)	When the panel is broken, don't touch the glass. Although the panel is difficult to be scattered, touching the broken part may hurt your hands.
k)	Liquid crystal contained in the panel may leak if the LCD is broken. Rinse it as soon as possible if it gets inside your eye or mouth by mistake.
l)	Don't touch the circuit and the pattern of the board. If you touch it, the circuit may be broken.
m)	Follow the regulations when LCD module is scrapped. The government you stay may have some regulations about it.
n)	After peel off the protection film, do not attach a lamination etc on the polarizer surface. If LCD reattached a lamination film and storage a long terms, the polarizer may discolor.

【Precautions of Set-Design】	
a)	Notice : Never take to pieces the module , because it will cause failure.
b)	Be sure to design the cabinet so that the module can be installed without any extra stress such as warp or twist.
c)	Connect GND to frame of module to stabilize against EMI and external noise.
d)	Since there is a circuit board in the module back, stress is not added at the time of a design assembly. Please make it like. If stress is added, there is a possibility that circuit parts may be damaged.
e)	It causes an irregular display and the defective indication, etc., when always put constant pressure on the back of the module. Please do not make the structure to press the back of the module.
f)	Be careful of a back light FPC not to pull by force at the time of the connecting to FPC processing.
g)	The polarizer surface on the panel is treated with Anti-Glare for low reflection. In case of attaching be sure to design the cabinet so that the module can be installed without any extra stress such as warp or twist.
h)	Don't change the volume of LCD module. It is optimized when the shipping. Any change may not meet the specification.
i)	If a minute particle enters in the module and adheres to an optical material, it may cause display non-uniformity issue, etc. Therefore, fine-pitch filters have to be installed to cooling and inhalation hole if you intend to install a fan.
j)	To avoid a partial temperature change of LCD module, please consider the part arrangement and the design for the heat radiation.
k)	Be sure to follow the absolute maximum rating in the specification. The design should consider the surrounding temperature, the fluctuating input signal, and tolerance of the electronic parts. Exceeding values is possible to cause worse characteristic such as burn and/or broken of the parts on LCD module.
l)	Be sure to use LCD module within the recommended operating conditions. Operating module out of the recommended range is not guaranteed even if it is in the absolute maximum rating.
m)	Follow the power, signal, and supply voltage sequence which the specification indicates, regarding on-off input signal after power on of LCD module.
n)	According to the using application, power circuit protection is recommended at module failure.

【Operation of precautions】	
a)	Do not expose the LCD panel to direct sunlight. Lightproof shade etc. should be attached when LCD panel is used under such environment.
b)	When handling LCD modules and assembling them into cabinets, please avoid that long-terms storage in the environment of oxidization or deoxidization gas and the use of such materials as reagent, solvent, adhesive, resin, etc. which generate these gasses, may cause corrosion and discoloration of the modules. Do not use the LCD module under such environment.
c)	An abnormal display by changing in quality of the polarizing plate might occur regardless of contact or no contact to the polarizing plate, because of epoxy resin (amine system curing agent) that comes out from the material and the packaging material used for the set side, the silicon adhesive (dealcoholization system and oxime system), and the tray blowing agents (azo-compound), etc. Please confirm adaptability with your employed material.
d)	Don't use polychloroprene (CR) with LCD module. It will generate chlorine gas, which will damage the reliability of the connection part on LCD panel.
e)	Be careful when using it for long time with fixed pattern display as it may cause accidental image. Please use a screen saver etc., in order to avoid an afterimage.
f)	The LED (Light Emitting Diode) used in this LCD module is very sensitive to temperature change. If it operates for extremely long time under high temperature, it is possible rapidly to shorten the life time of LED. In case of such a condition, consult with us.
g)	If stored at the temperatures lower than the rated storage temperature, the LC may freeze and it may cause LCD panel damage. If storage temperature exceeds the specified rating, the molecular orientation of the LC may change to that of a liquid, and they may not revert to their original state. Store the module in normal room temperature.
h)	Keep LCD module in the range of the specified temperature conditions at all times. Once out of the range, liquid crystal will lose its characteristics, and it cannot recover.
i)	Nature of dew consideration prevention is necessary when LCD is used for long time under high-temperature and high-humidity.

11. Packing form

Product countries	China
Piling number of cartons	Max. 6 cartons
Package quantity in one carton	50 pcs
Carton size	380mm(W) 313mm(H) 340mm(D)
Total mass of one carton filled with full modules	15.5kg
Packing form is shown	Fig.2

12. Reliability test items

No.	Test item	Conditions	Remark
1	High temperature storage test	Ambient temperature 80°C 240H	【Note1】
2	Low temperature storage test	Ambient temperature -30°C 240H	【Note1】
3	High temperature & high humidity operation test	Ambient temperature 40°C、Humidity 95% RH 240H (No condensation.)	【Note1】
4	High temperature operation test	LCD outside temperature 75°C 240H	【Note1】
5	Low temperature operation test	Ambient temperature -20°C 240H	【Note1】
6	Vibration test (non-operating)	<Sine wave> Frequency : 10~500Hz/Gravity: 14.7m/s ² Test period : 3H(X, Y, Z direction 1H)	【Note1】
7	Shock test (non-operating)	Max. gravity: 2352m/s ² Pulse width: 11ms Direction: ±X, ±Y, ±Z Test period : 1time/1 direction	【Note1】
8	Thermal shock test	-30°C[0.5h]~80°C[0.5h]/50cycles	【Note1】

【Note1】Under the display quality test conditions with normal operation state, these shall be no change which may affect practical display function.

(Normal operation state: Temperature: 15~35°C, Humidity: 45~75%, Atmospheric pressure: 86~106kpa)

13. Others

13-1 Lot No. Label

The label that displays "SHARP" Model No.(LQ090Y3DG01) Lot No. is stuck on the back of the module.

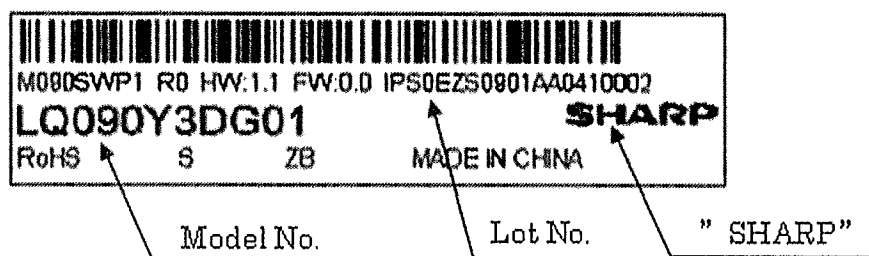

13-2. Packing box Label:

The label that displays ①Model number (LQ090Y3DG01) ②Shipping date ③Quantity of module is stuck on the packing box. Moreover, the display of bar code also applies to this.

社内品番:(4S) LQ090Y3DG01	
Bar code (①)	
Lot No. : (1T) 2012.07.01	* *
Bar code (②)	
Quantity : (Q) 50 pcs	
Bar code (③)	
Carton: *****	
Bar code (④)	
シャープ物流用ラベルです。	

①Model number (LQ090Y3DG01)

②Shipping date

③Quantity of module

④(Our management number)

A right picture is written to the packing box of module for the RoHS restriction.

※ R.C. (RoHs Compliance) means these parts have corresponded with the RoHs directive.

This module corresponds from the first sample to RoHS Directive.



R.C.

The figure below is written under the SHARP logo of the packing box about the production country.

MADE IN CHINA

13-3 The ozone-depleting substances is not used.

13-4. If any problem occurs in relation to the description of this specification , it shall be resolved through discussion with spirit of cooperation.

14. Storage conditions

·Environmental condition range of storage temperature and humidity

Temperature: 0 to 40 degrees Celsius

Relative humidity: 90% and below

【Note】

Please refer below as a mean value of the environmental conditions.

Summer time temperature 20 to 35 degrees Celsius humidity, 85% and below

Winter time temperature 5 to 15 degrees Celsius humidity, 85% and below

Please maintain within 240 hours of accumulated length of storage time, with conditions of 40 degrees Celsius and room humidity of 90%.

·Direct sun light

Please keep the product in a dark room or cover the product to protect from direct sun light.

·Atmospheric condition

Please refrain from keeping the product with possible corrosive gas or volatile flux.

·Prevention of dew

Please store the product carton either on a wooden pallet or a stand / rack to prevent dew.

Do not place directly on the floor. In addition, to obtain moderate ventilation in between the pallet's top and bottom surfaces, pile the cartons up in a single direction and in order.

Please place the product cartons away from the storage wall.

·Storage period

Within above mentioned conditions, maximum storage period should be one year.

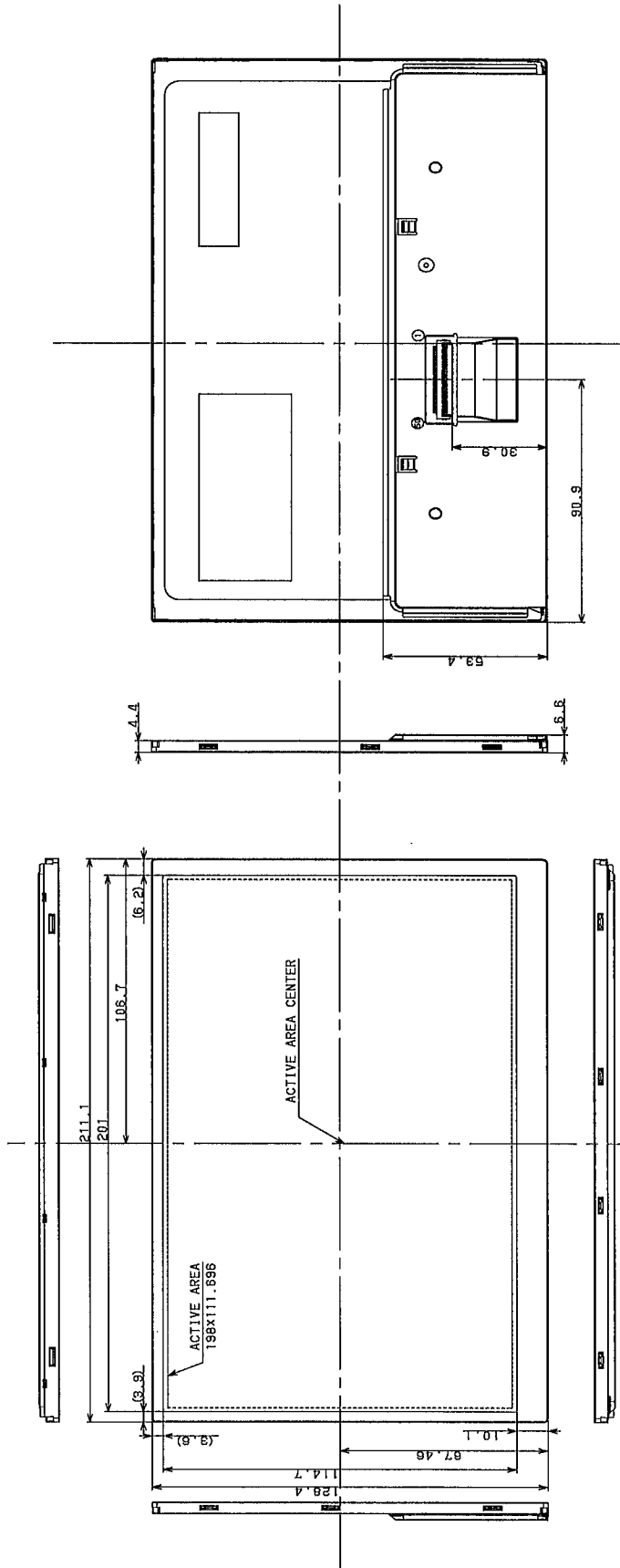

NOTES

- 1) Unspecified tolerance to be ± 0.5
- 2) Take care in set design to hide the scratches and bubbles appered on the polarizer or other flame area which is located outside of active area.
- 3) Please fix the module on the same plane, taking care not to wrap or twist the module.
- 4) Please avoid to press back panel by sharp edged item. And please confirm area pressed or contacted has no scratch/damage after vibration/shock test.

Bezel/Display position

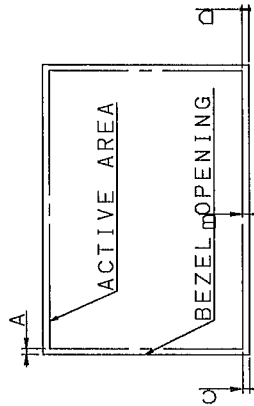

- 2) Tolerance Y direction B: 1.5 ± 0.8
- 2) Tolerance Y direction B: 1.5 ± 0.8
- 3) Obliquity of display area $|C-D| < 0.8$

Fig.1 Outline Dimensions

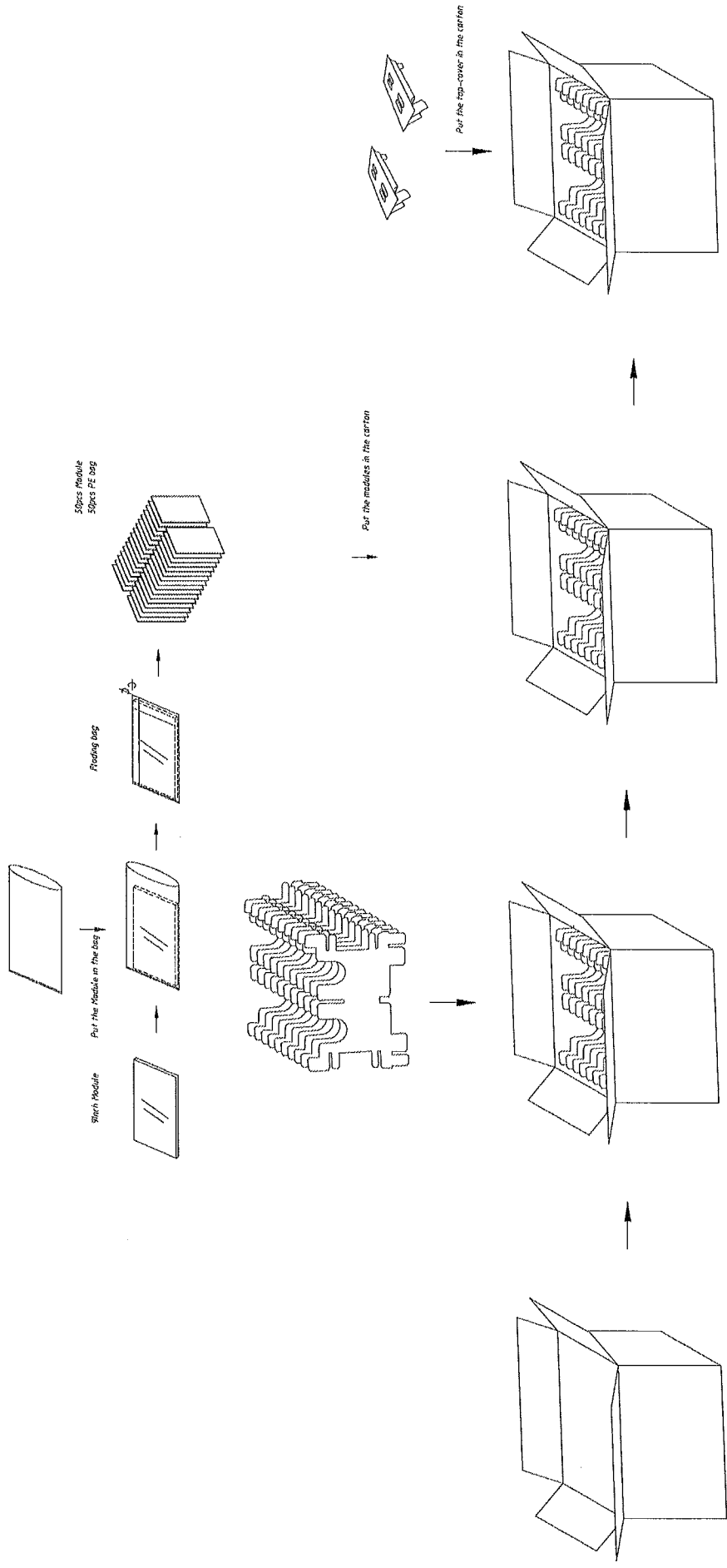

Fig.2 Packing form