

Class-AB Speaker Amplifiers

5W+5W
Stereo Speaker Amplifiers

BA5406,BA5417

No.11077ECT02

●Description

The BA5406/BA5417 is a dual OTL monolithic power IC with two built-in, high output speaker amplifier circuits. High output of 5W×2 can be produced when $V_{CC}=12\text{ V}$ and $R_L=3\Omega$, and 2.8 W×2 when $V_{CC}=9\text{ V}$ and $R_L=3\Omega$. The BA5406, which uses a high allowable power dissipation package, has a simple heatsink design. The BA5417 not only exceeds basic characteristics, but also has a built-in soft clip circuit, thermal shutdown and standby circuits.

●Features

BA5406

- 1) Good low voltage characteristics (Operation from $V_{CC}=5\text{ V}$)
- 2) Ripple filter (6pin) also can be used as muting pin (Make 6pin GND potential)
- 3) Small thermal resistance package and simple heatsink design

BA5417

- 1) Small pop noise when standby switches ON/OFF
- 2) Built-in circuit to prevent ripple addition when motor starts
- 3) Built-in thermal shutdown circuit
- 4) Built-in standby switch circuit
- 5) Built-in soft clip circuit

●Applications

Stereo radio cassette players, mini-audio systems, LCD TVs, etc.

●Line up matrix

Part No.	BA5406	BA5417	Units
Supply voltage	5 ~ 15	6 ~ 15	V
Power dissipation	20	15	W
Quiescent current	40	22	mA
Standby current	—	0	μA
Closed loop voltage gain	46	45	dB
Output noise voltage	0.6	0.3	mVrms
Total harmonic distortion	0.3	0.1	%
Ripple rejection	—	55	dB
Package	SIP-M12	HSIP15	—

● Absolute maximum ratings (Ta=25°C)

Parameter	Symbol	Ratings		Unit
		BA5406	BA5417	
Supply voltage	V _{CC}	18 ^{*1}	20 ^{*1}	V
Power dissipation	P _d	20 ^{*2}	15 ^{*3}	W
Operating temperature	T _{opr}	-20 ~ +75	-20 ~ +75	°C
Storage temperature	T _{stg}	-30 ~ +125	-55 ~ +150	°C

*1 When no signal

*2 Back metal temperature 75°C

*3 Ta=75°C (Using infinite heatsink)

● Operating range (Ta=25°C)

Parameter	Symbol	Ratings		Unit
		BA5406	BA5417	
Supply voltage	V _{CC}	5.0 ~ 15.0	6.0 ~ 15.0	V

● Electrical characteristics (BA5406 : Unless otherwise noted, Ta=25°C, V_{CC}=12V)
(BA5417 : Unless otherwise noted, Ta=25°C, V_{CC}=9V)

Parameter	Symbol	Limits		Unit.	Conditions	
		BA5406	BA5417			
Quiescent current	I _o	40	22	mA	V _{IN} =0Vrms	
Rated output power	P _{OUT}	5.0	5.0	W	THD=10%, V _{CC} =12V, R _L =3Ω	
Closed loop voltage gain	G _{VC}	46	45	dB	—	
Output noise voltage	V _{NO}	0.6	0.3	mVrms	R _g =10kΩ, DIN-Audio	
Total harmonic distortion	THD	0.3	0.1	%	P _{OUT} =0.5W, f=1kHz	
Ripple rejection	RR	—	55	dB	f _{RR} =100Hz, V _{RR} =-10dBm	
Crosstalk	CT	—	65	dB	V _O =0dBm	
Standby current	I _{OFF}	—	0	μA	—	
Standby pin input current	I _{SIN}	—	0.15	mA	V _{STBY} =V _{CC}	
Standby pin control voltage	Activated	V _{STH}	—	3.5 ~ V _{CC}	V	—
	Not Activated	V _{STL}	—	0 ~ 1.2	V	—

* Note: This IC is not designed to be radiation-resistant.

●Block diagram

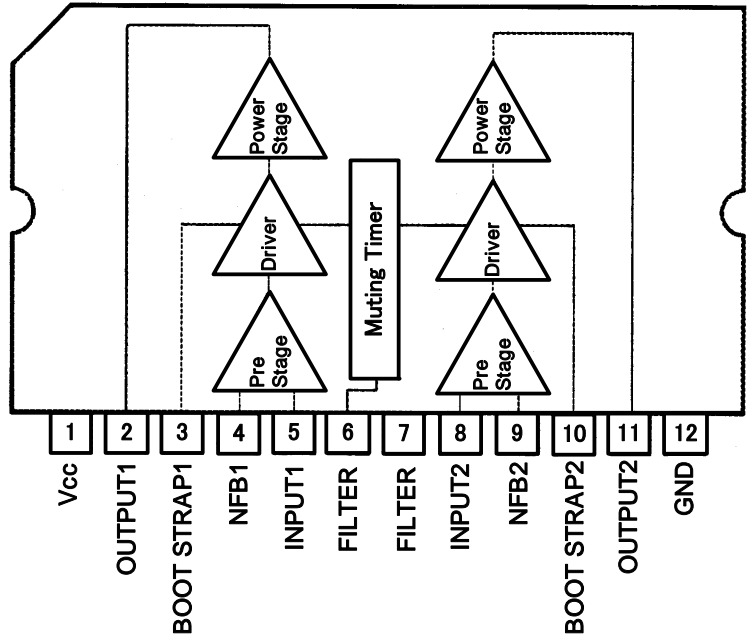

Fig.1 BA5406

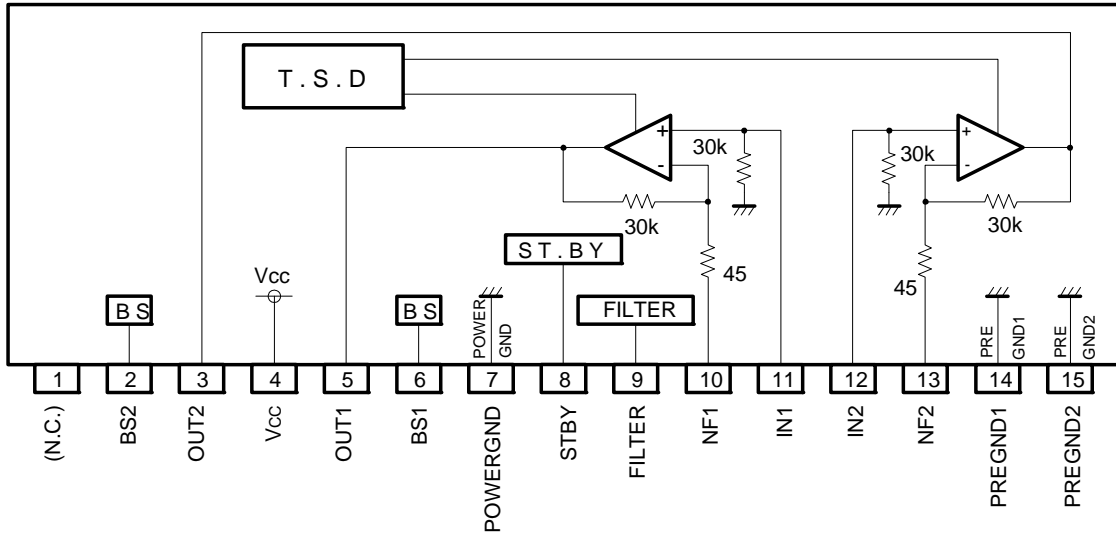

Fig.2 BA5417

● Application circuit
BA5406

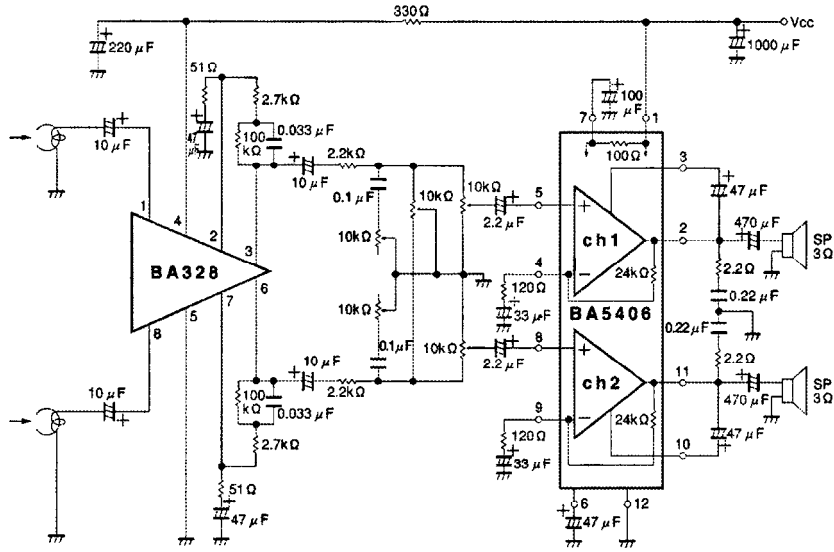

Fig.5

BA5417
OTL mode circuit

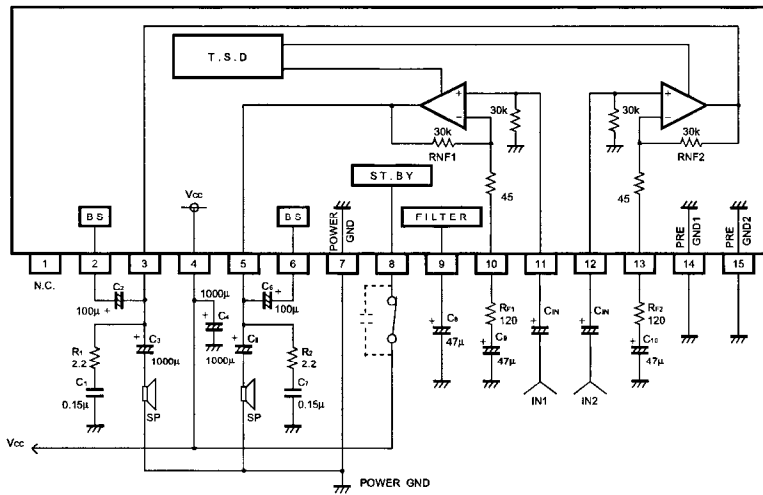

Fig.6

BTL mode circuit

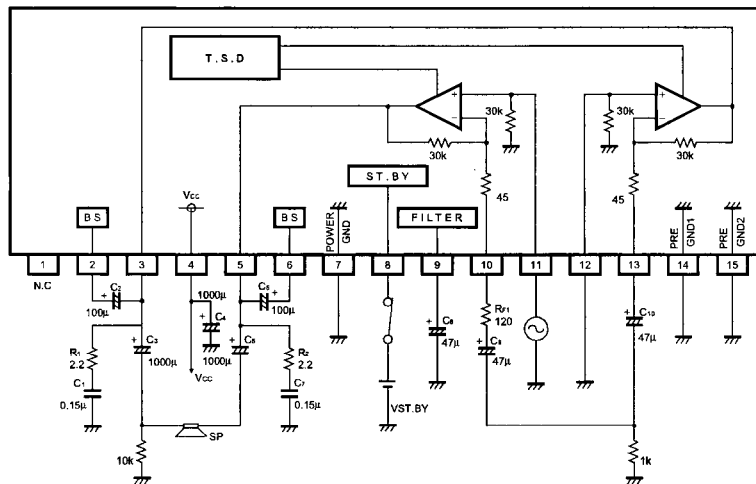

Fig.7

●Reference data

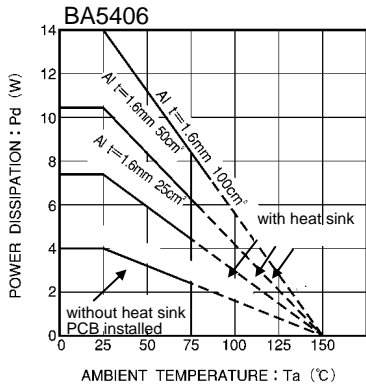

Fig.8 Thermal derating curve

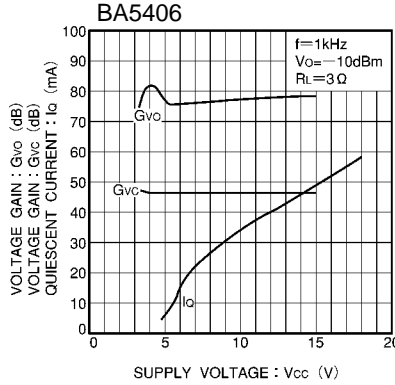

Fig.9 Quiescent current and voltage gain vs Supply voltage

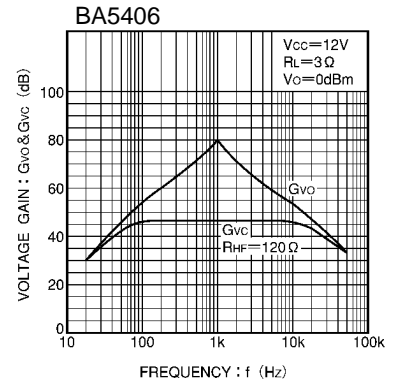

Fig.10 Voltage gain vs frequency

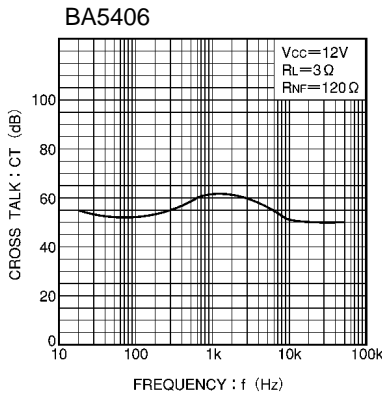

Fig.11 Crosstalk vs frequency

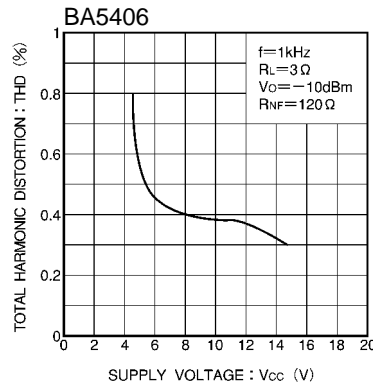

Fig.12 Distortion vs power supply voltage

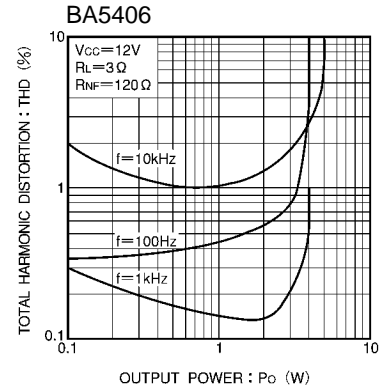

Fig.13 Distortion vs Output power

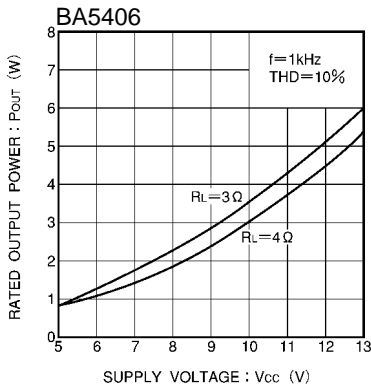

Fig.14 Output power vs power supply voltage

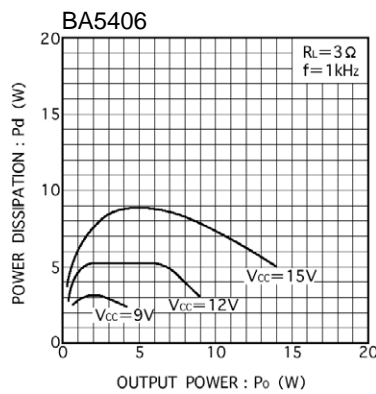

Fig.15 Power dissipation vs Output power(1)

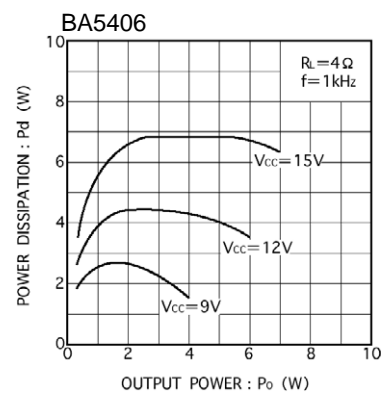

Fig.16 Power dissipation vs Output power(2)

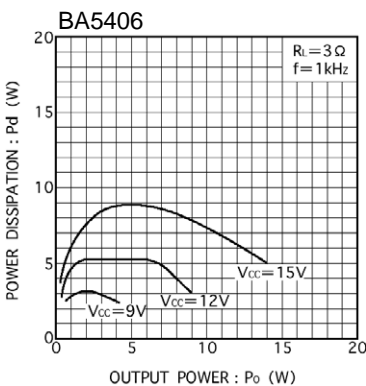

Fig.17 Power dissipation vs Output power(3)

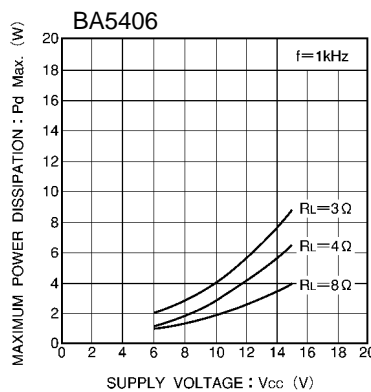

Fig.18 Maximum power dissipation vs Supply voltage

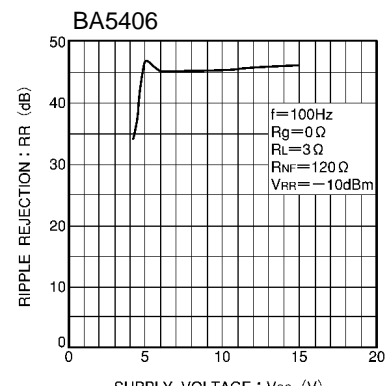

Fig.19 Ripple rejection ratio vs Supply voltage

BA5417 OTL mode

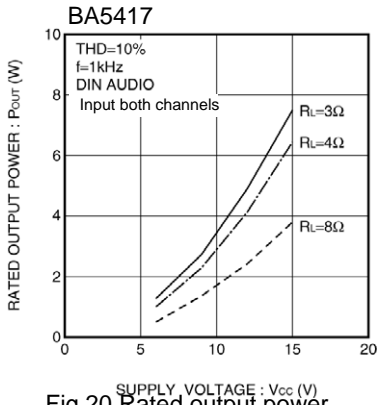

Fig.20 Rated output power vs Supply voltage

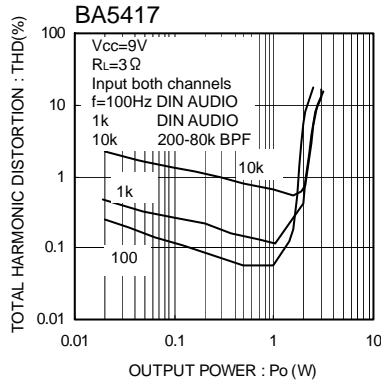

Fig.21 Total harmonic distortion vs Output power

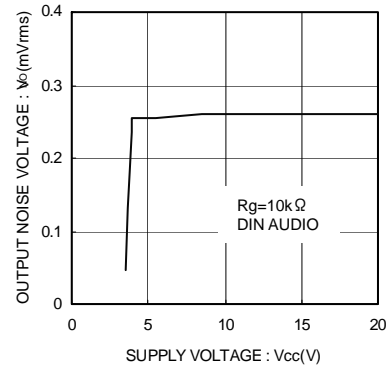

Fig.22 Output noise voltage vs Supply voltage

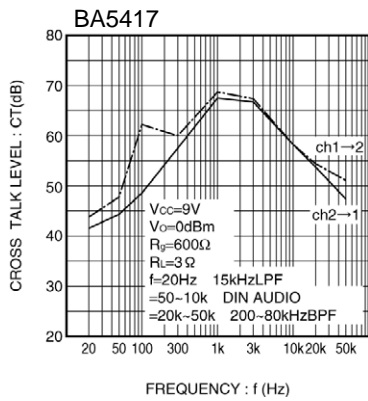

Fig.23 Crosstalk vs. Frequency

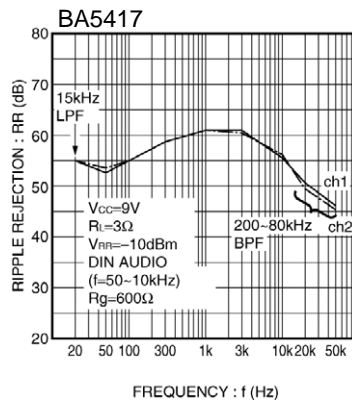

Fig.24 Ripple rejection vs. Frequency

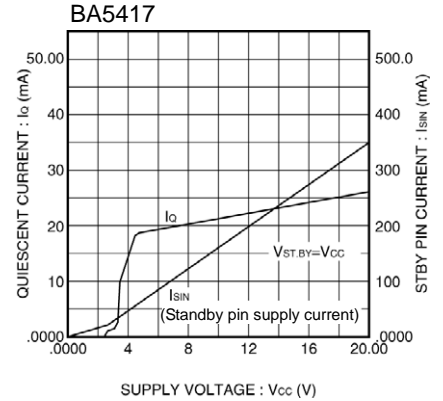

Fig.25 Quiescent, standby pin input current vs. Supply voltage

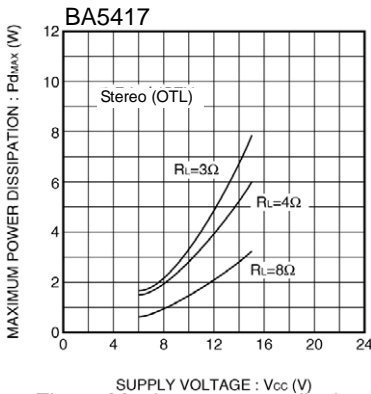

Fig.26 Maximum power dissipation vs. Supply voltage

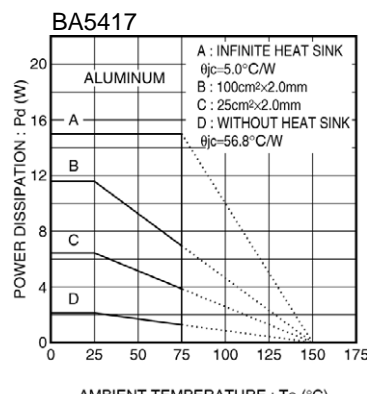

Fig.27 Thermal derating curve

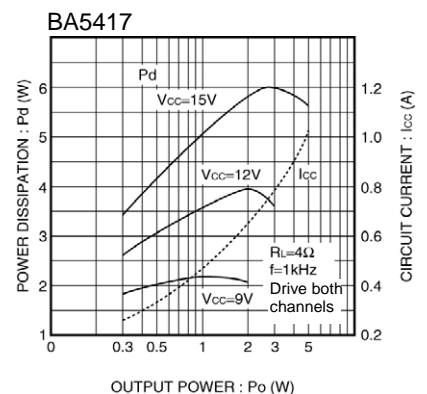

Fig.28 Power dissipation, circuit current vs. Supply Voltage (RL=4Ω)

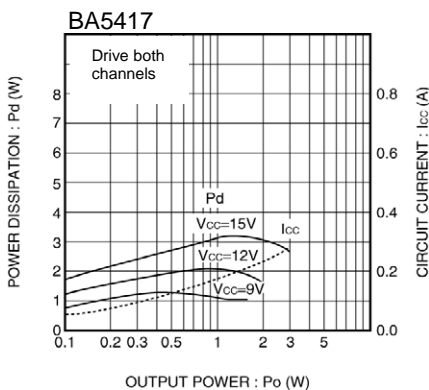

Fig.29 Power dissipation, circuit current vs. Supply Voltage (RL=8Ω)

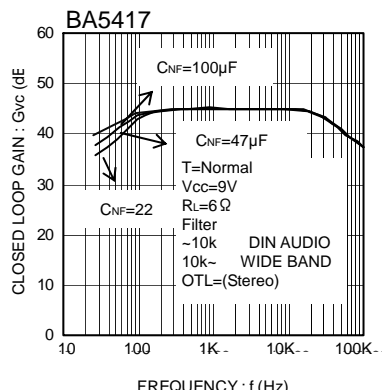

Fig.30 Closed loop gain vs. Frequency

BA5417 BTL mode

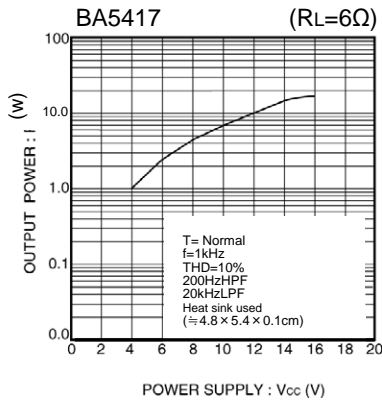

Fig.31 Rated output power vs. Supply Voltage

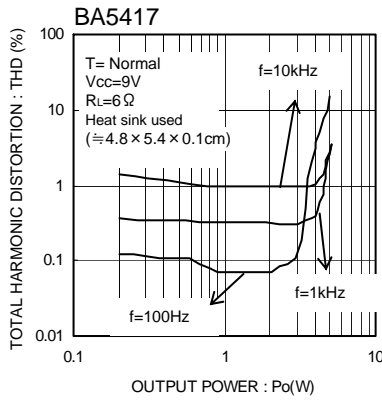

Fig.32 Total harmonic distortion vs. Output power

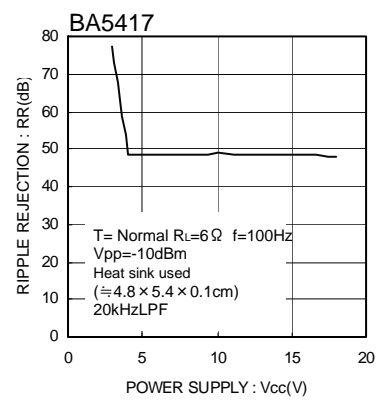

Fig.33 Ripple rejection ratio vs. Supply Voltage

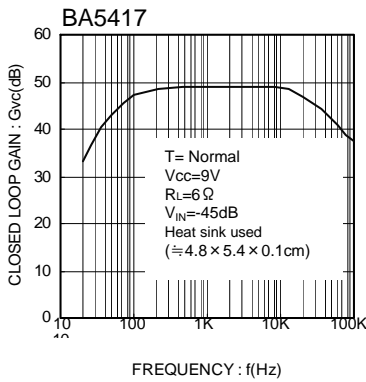

Fig.34 Close loop gain vs. Frequency

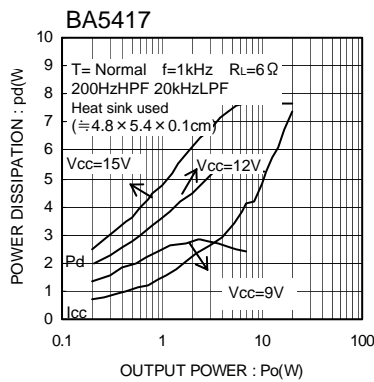

Fig.35 Power dissipation, Supply current vs. Frequency

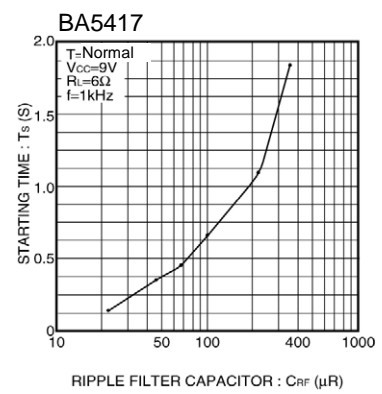

Fig.36 Starting time vs. Ripple filter capacitor

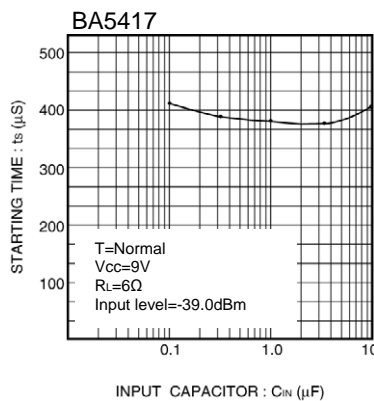

Fig.37 Starting time vs. Input coupling capacitor

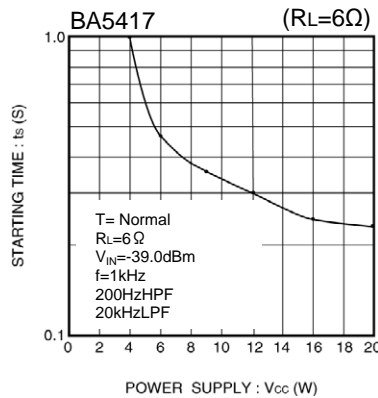

Fig.38 Starting time vs. Supply Voltage

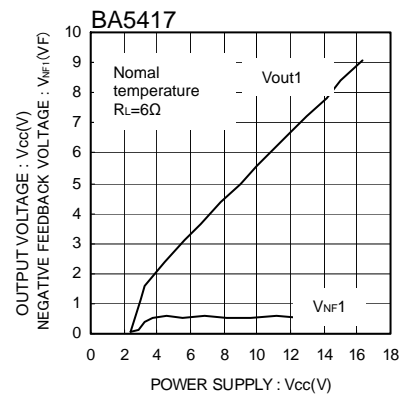

Fig.39 Output voltage, Negative feed back voltage vs. Supply Voltage

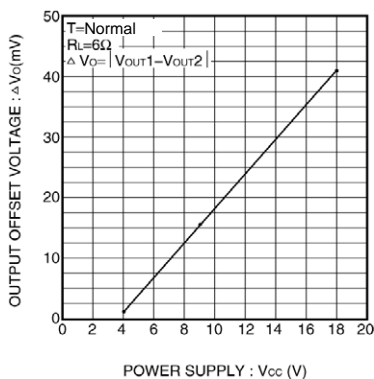

Fig.40 Output offset voltage vs. Supply Voltage

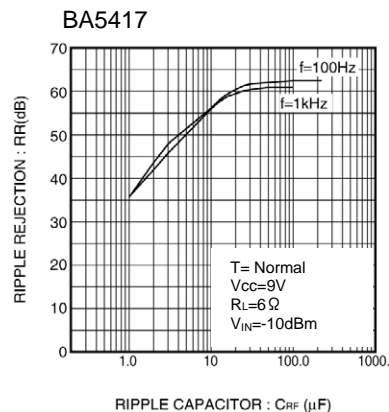

Fig.41 Ripple rejection vs. Ripple filter capacitor

●Notes for use

- 1) Numbers and data in entries are representative design values and are not guaranteed values of the items.
- 2) Although ROHM is confident that the example application circuit reflects the best possible recommendations, be sure to verify circuit characteristics for your particular application. Modification of constants for other externally connected circuits may cause variations in both static and transient characteristics for external components as well as this Rohm IC. Allow for sufficient margins when determining circuit constants.
- 3) Absolute maximum ratings
Use of the IC in excess of absolute maximum ratings, such as the applied voltage or operating temperature range (Topr), may result in IC damage. Assumptions should not be made regarding the state of the IC (short mode or open mode) when such damage is suffered. A physical safety measure, such as a fuse, should be implemented when using the IC at times where the absolute maximum ratings may be exceeded.
- 4) GND potential
Ensure a minimum GND pin potential in all operating conditions. Make sure that no pins are at a voltage below the GND at any time, regardless of whether it is a transient signal or not.
- 5) Thermal design
Perform thermal design, in which there are adequate margins, by taking into account the permissible dissipation (Pd) in actual states of use.
- 6) Short circuit between terminals and erroneous mounting
Pay attention to the assembly direction of the ICs. Wrong mounting direction or shorts between terminals, GND, or other components on the circuits, can damage the IC.
- 7) Operation in strong electromagnetic field
Using the ICs in a strong electromagnetic field can cause operation malfunction.

●Ordering part number

B	A
---	---

Part No.

5	4	0	6
---	---	---	---

Part No.
5406
5417

--	--

Package
None: SIP-M12
HSIP15

--	--

Packaging and forming specification
None: Tube

SIP-M12

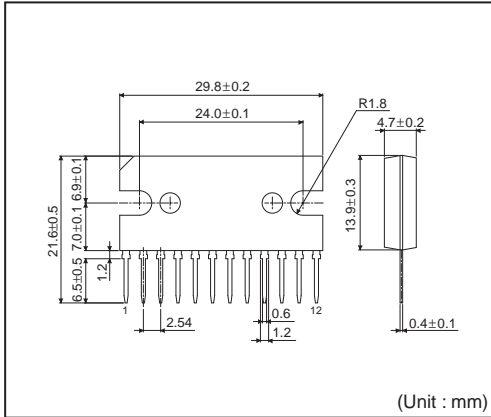

<Tape and Reel information>

Container	Tube
Quantity	300pcs
Direction of feed	Direction of products is fixed in a container tube

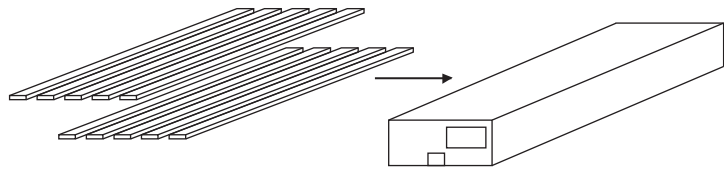

* Order quantity needs to be multiple of the minimum quantity.

HSIP15

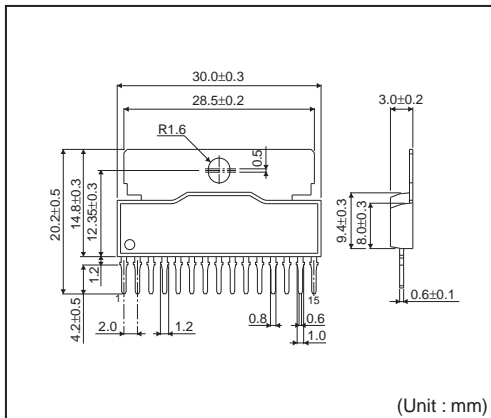

<Tape and Reel information>

Container	Tube
Quantity	300pcs
Direction of feed	Direction of products is fixed in a container tube

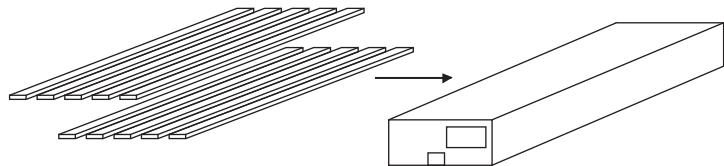

* Order quantity needs to be multiple of the minimum quantity.

Notes

No copying or reproduction of this document, in part or in whole, is permitted without the consent of ROHM Co.,Ltd.

The content specified herein is subject to change for improvement without notice.

The content specified herein is for the purpose of introducing ROHM's products (hereinafter "Products"). If you wish to use any such Product, please be sure to refer to the specifications, which can be obtained from ROHM upon request.

Examples of application circuits, circuit constants and any other information contained herein illustrate the standard usage and operations of the Products. The peripheral conditions must be taken into account when designing circuits for mass production.

Great care was taken in ensuring the accuracy of the information specified in this document. However, should you incur any damage arising from any inaccuracy or misprint of such information, ROHM shall bear no responsibility for such damage.

The technical information specified herein is intended only to show the typical functions of and examples of application circuits for the Products. ROHM does not grant you, explicitly or implicitly, any license to use or exercise intellectual property or other rights held by ROHM and other parties. ROHM shall bear no responsibility whatsoever for any dispute arising from the use of such technical information.

The Products specified in this document are intended to be used with general-use electronic equipment or devices (such as audio visual equipment, office-automation equipment, communication devices, electronic appliances and amusement devices).

The Products specified in this document are not designed to be radiation tolerant.

While ROHM always makes efforts to enhance the quality and reliability of its Products, a Product may fail or malfunction for a variety of reasons.

Please be sure to implement in your equipment using the Products safety measures to guard against the possibility of physical injury, fire or any other damage caused in the event of the failure of any Product, such as derating, redundancy, fire control and fail-safe designs. ROHM shall bear no responsibility whatsoever for your use of any Product outside of the prescribed scope or not in accordance with the instruction manual.

The Products are not designed or manufactured to be used with any equipment, device or system which requires an extremely high level of reliability the failure or malfunction of which may result in a direct threat to human life or create a risk of human injury (such as a medical instrument, transportation equipment, aerospace machinery, nuclear-reactor controller, fuel-controller or other safety device). ROHM shall bear no responsibility in any way for use of any of the Products for the above special purposes. If a Product is intended to be used for any such special purpose, please contact a ROHM sales representative before purchasing.

If you intend to export or ship overseas any Product or technology specified herein that may be controlled under the Foreign Exchange and the Foreign Trade Law, you will be required to obtain a license or permit under the Law.



Thank you for your accessing to ROHM product informations.
More detail product informations and catalogs are available, please contact us.

ROHM Customer Support System

<http://www.rohm.com/contact/>