

rev	ecn no	dr	date
A	V06-1178	LP	2006-12-12
B	V07-0440	LP	2007-07-05
C	V09-0071	PK	2009-02-24

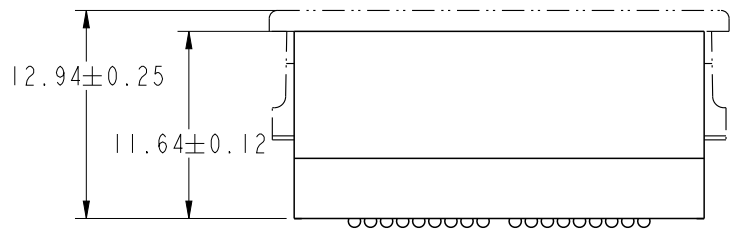
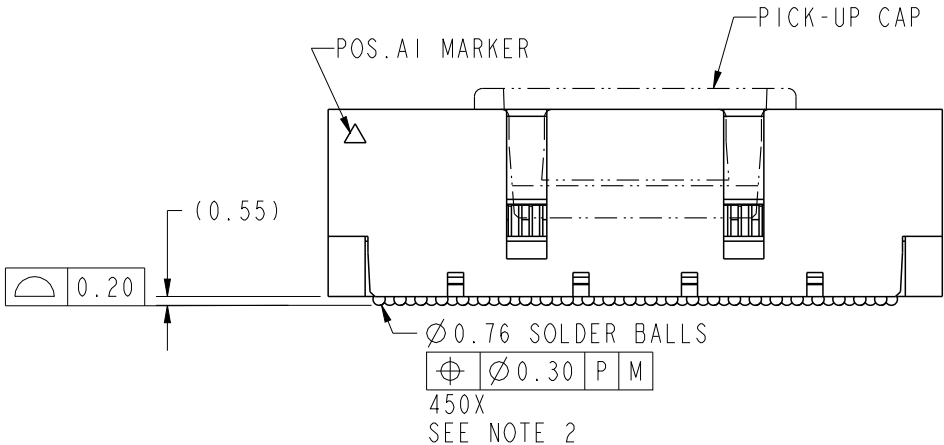
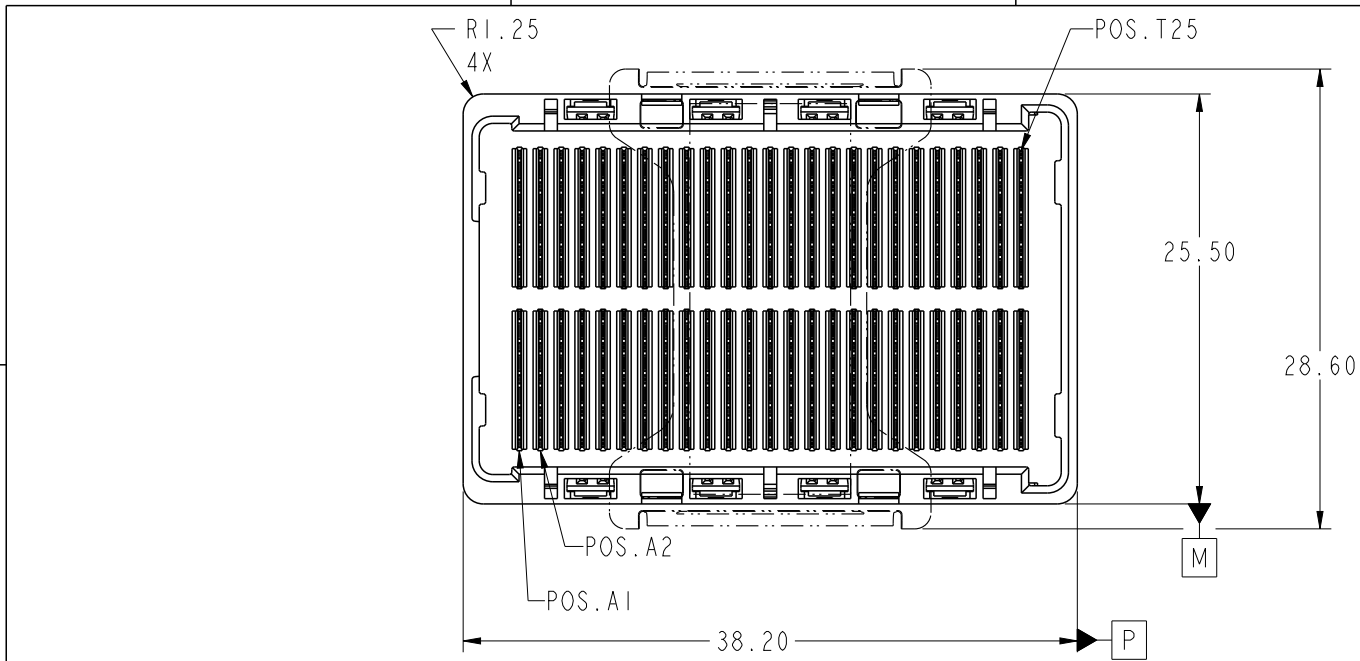

Copyright FCI.

spec ref	-	dr	Bill Lin	2010/02/02	projection 	mm 	size	A4	scale	1:1		
tolerance std	TOLERANCES UNLESS OTHERWISE SPECIFIED	eng	Nickor Zuo	2011/05/26			ecn no	ELX-DG-003943-1				
ASME Y14.5		chr	Alex Cao	2011/06/24				rel level	Released			
surface	✓	appr	Pei-Ming Zheng	2011/06/27	product family	GIG-Array		rev	D			
-	linear	0.X	±0.30	www.fci.com	title	GIG-Array		dwg no	10026802			
		0.XX	±0.10			12mm PLUG ASSY. 200 SIG. POS.			Product - Customer Drw		sheet 1 of 5	
	angular	0°	±2°			cat. no.						

ProjE File - REV C - 2009-06-09



Copyright FCI.

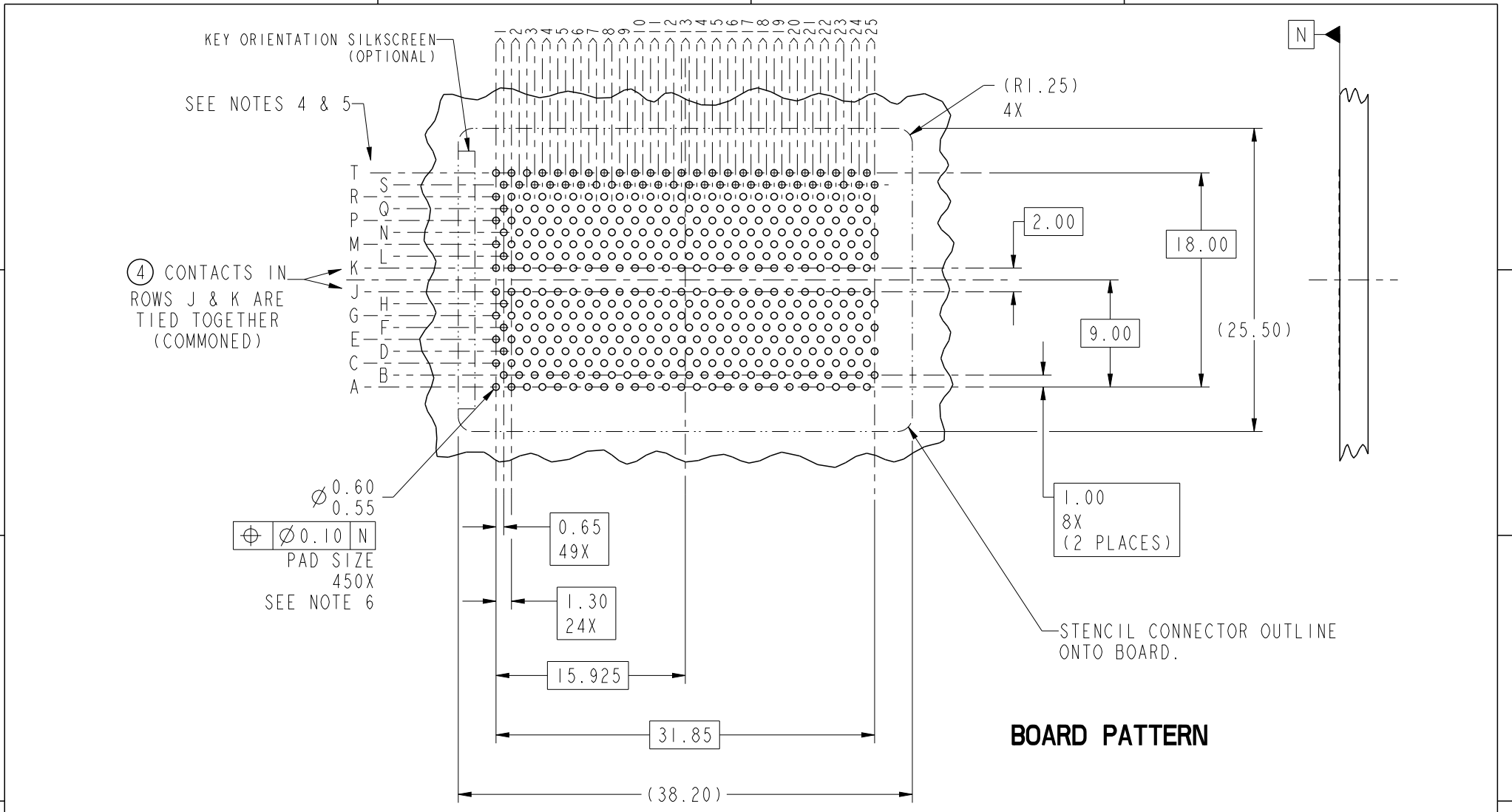

**BOARD PATTERN**

spec ref	-	dr	Bill Lin	2010/02/02	projection	mm	size	A4	scale	1:1
tolerance std	ASME Y14.5	eng	Nickor Zuo	2011/05/26			ecn no		ELX-DG-003943-1	
		chr	Alex Cao	2011/06/24			rel level		Released	
surface	✓	appr	Pei-Ming Zheng	2011/06/27	product family		GIG-Array		rev	
					title		GIG-Array		10026802	
					12mm PLUG ASSY. 200 SIG. POS.		cat. no.		Product - Customer Drw	
					www.fci.com		sheet 2 of 5		D	

PrdE File - REV C - 2009-06-09

1

2

3

4

A

B

C

D

A

B

C

D

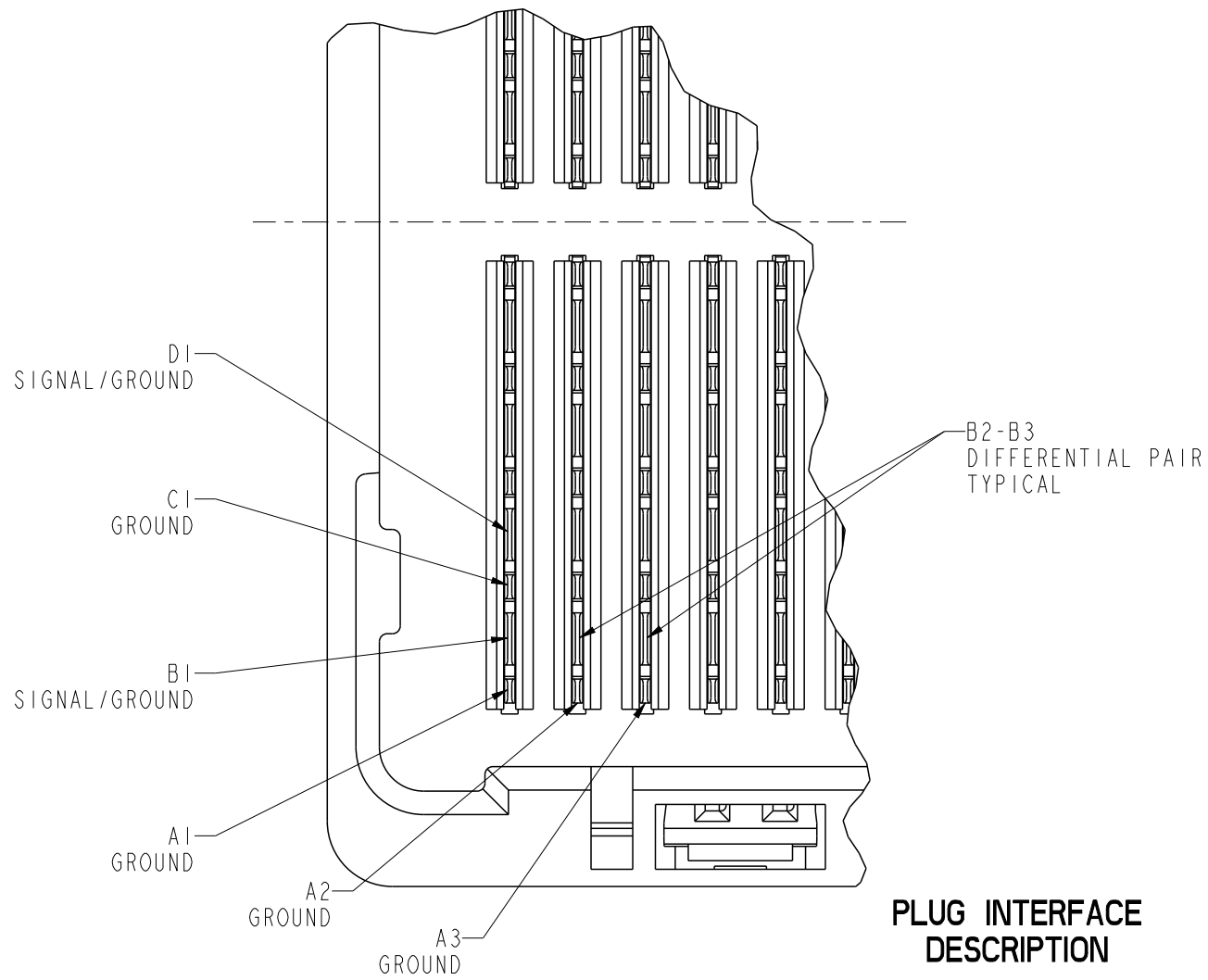

**PLUG INTERFACE DESCRIPTION**



Copyright FCI.

spec ref		-		dr	Bill Lin	2010/02/02	projection 	mm 	size	A4	scale	1:1	
tolerance std	ASME Y14.5	TOLERANCES UNLESS OTHERWISE SPECIFIED				eng			Nickor Zuo	2011/05/26	ecn no	ELX-DG-003943-1	
						chr			Alex Cao	2011/06/24		rel level	Released
surface	✓	linear	0.X	±0.30	 <b>www.fci.com</b>	title GIG-Array 12mm PLUG ASSY. 200 SIG. POS.	product family GIG-Array	dwg no 10026802	rev <b>D</b>	-			
			0.XX	±0.10						cat. no.	Product - Customer Drw	sheet 3 of 5	
			0.XXX	±0.05									-
		angular	0°	±2°	-		-		-				

PreE File - REV C - 2009-06-09

2

3

4

**FLAT AREA  
PICK-UP CAP**

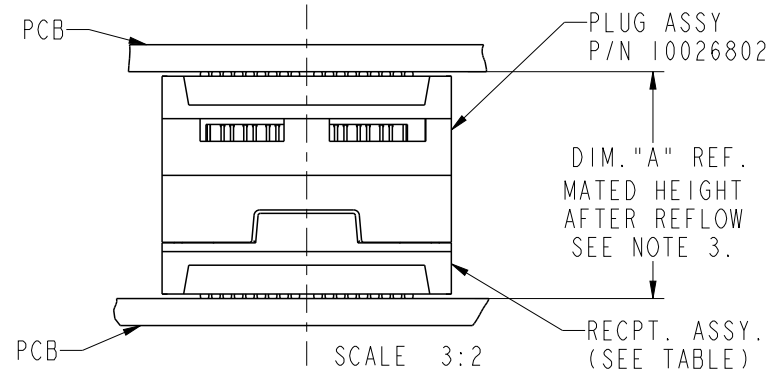
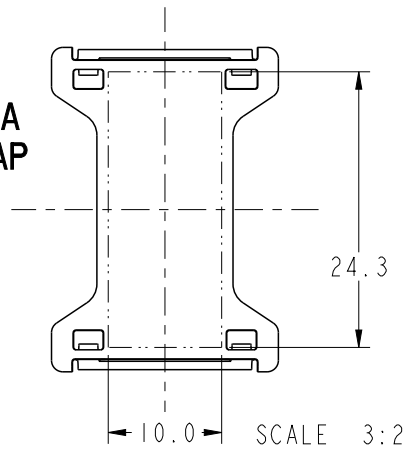

**END VIEW OF MATED CONNECTORS**

DIM. "A"	RECPT. ASSY. P/N
17	55740
22	10026010
27	55741



Copyright FCI.

spec ref		-		dr	Bill Lin	2010/02/02	projection 	mm 	size	A4	scale	1:1				
tolerance std	ASME Y14.5	TOLERANCES UNLESS OTHERWISE SPECIFIED				eng			Nickor Zuo	2011/05/26	ecn no	ELX-DG-003943-1				
						chr			Alex Cao	2011/06/24		product family	GIG-Array		rel level	Released
surface	✓	linear	0.X	±0.30		title	GIG-Array		dwg no	10026802			rev	D		
		0.XX	±0.10	www.fci.com								cat. no.	Product - Customer Drw		sheet 4 of 5	
		0.XXX	±0.05													

PRODUCT NUMBER	SOLDER BALL COMPOSITION	CONTACT PLATING PERFORMANCE LEVEL
10026802-001	STANDARD (EUTECTIC)	PERFORMANCE-BASED PLATING, QUALIFIED TO MEET THE REQUIREMENTS OF FCI PRODUCT SPECIFICATION GS-12-192, INCLUDING TELCORDIA CENTRAL OFFICE
10026802-001LF	LEADFREE	

**NOTES:**

- ① MAT'L:  
HOUSING: LCP  
CONTACT: COPPER ALLOY  
PLATING (CONTACT): Au OVER Ni.  
UL RATING: 94 V-0
- ② SOLDER BALLS WILL NOT BE PERFECT SPHERICAL SHAPE DUE TO REFLOW ATTACHMENT.
- ③ MATED HEIGHT EFFECTED BY CUSTOMERS' PCB PAD SIZE, PLATING, SOLDER REFLOW PROFILE & SOLDER PASTE.
- ④ CONTACTS IN ROWS A,C,E,G,J,K,M,P,R AND T ARE SINGLE BEAM CONTACTS, TYPICALLY USED AS GROUND PINS. (NOTE: CONTACTS IN ROWS J & K ARE TIED TOGETHER [COMMONED])
- ⑤ CONTACTS IN ROWS B,D,F,H,L,N,Q AND S ARE DUAL BEAM CONTACTS, TYPICALLY USED AS SIGNAL PINS.

NOTES CONTINUED

- ⑥ SPECIFIED POSITIONAL TOLERANCE DEFINES PAD TO PAD LOCATION WITHIN LAND PATTERN. POSITIONAL TOLERANCE OF LAND PATTERN TO FUDICIAL MARKS OR PCB DATUMS SHALL BE DEFINED BY CUSTOMER. FOR RECOMMENDED PRODUCT APPLICATION AND PCB DESIGN DETAILS, SEE DOC. NO. GS-20-016.
- ⑦ FOR PROPER APPLICATION FOLLOW FCI APPLICATION SPECIFICATION GS-20-033 LEADFREE SOLDER BALLS WILL NOT SOLDER PROPERLY IN A LEADED SOLDER PROCESS DUE TO A HIGHER REFLOW TEMPERATURE, LEADFREE PRODUCT IS THEREFORE NOT BACKWARDS COMPATIBLE WITH LEADED OR SOME SOLDERING APPLICATIONS. REFERENCE FCI APPLICATION SPECIFICATION.
- ⑧ THIS PRODUCT MEETS THE EUROPEAN UNION DIRECTIVES AND OTHER COUNTRY REGULATIONS AS DESCRIBED IN GS-22-008. PRODUCT MEETING WITH THES DIRECTIVE IS IDENTIFIED IN THE LOT CODE NUMBER MARKED ON EACH PART BY HAVING AN "X" IN THE SEVENTH CHARACTER POSITION.



Copyright FCI.

spec ref	-	dr	Bill Lin	2010/02/02	projection 	mm 	size	A4	scale	1:1	
tolerance std	TOLERANCES UNLESS OTHERWISE SPECIFIED	eng	Nickor Zuo	2011/05/26			product family	GIG-Array	ecn no	ELX-DG-003943-1	
ASME Y14.5		chr	Alex Cao	2011/06/24				rel level	Released		
surface	linear	appr	Pei-Ming Zheng	2011/06/27	title	GIG-Array	dwg no	10026802	rev		
-	angular	www.fci.com		cat. no.						Product - Customer Drw	sheet 5 of 5

Prod File - REV C - 2009-06-09