

# ISL800xxxDEMO1Z Demonstration Boards User Guide

## Description

The ISL800xxxDEMO1Z boards are intended for use by individuals with requirements for point-of-load applications sourcing from 2.7V to 5.5V. The ISL800xxxDEMO1Z boards are used to demonstrate the performance of the [ISL80020](#), [ISL80020A](#), [ISL80015](#), and [ISL80015A](#) low quiescent current mode converter.

These devices are offered in an 8 Ld 2mmx2mm TDFN package with 1mm maximum height. The complete converter occupies less than 64mm<sup>2</sup> area.

## Specifications

These boards have been configured and optimized for the following operating conditions:

- $V_{IN}$  = 2.7V to 5.5V
- $V_{OUT}$  = 1.8V
- $I_{OUT}$  maximum
  - 2A for ISL80020, ISL80020A
  - 1.5A for ISL80015, ISL80015A
- Switching frequency
  - 2MHz for ISL80020A, ISL80015A
  - 1MHz for ISL80020, ISL80015
- Up to 95% peak efficiency

## Key Features

- Small, compact design
- $V_{IN}$  range of 2.7V to 5.5V
- $I_{OUT}$  maximum is 2A or 1.5A
- Switching frequency is 1MHz or 2MHz
- Negative current protection
- Internal soft-start and soft-stop
- Overcurrent and short-circuit protection
- Over-temperature/thermal protection

## Related Literature

- For a full list of related documents, visit our website
  - [ISL80020](#), [ISL80020A](#), [ISL80015](#), and [ISL80015A](#) product pages

## Ordering Information

PART NUMBER	DESCRIPTION
ISL80020DEMO1Z	2A, 1MHz demonstration board
ISL80020ADEMO1Z	2A, 2MHz demonstration board
ISL80015DEMO1Z	1.5A, 1MHz demonstration board
ISL80015ADEMO1Z	1.5A, 2MHz demonstration board

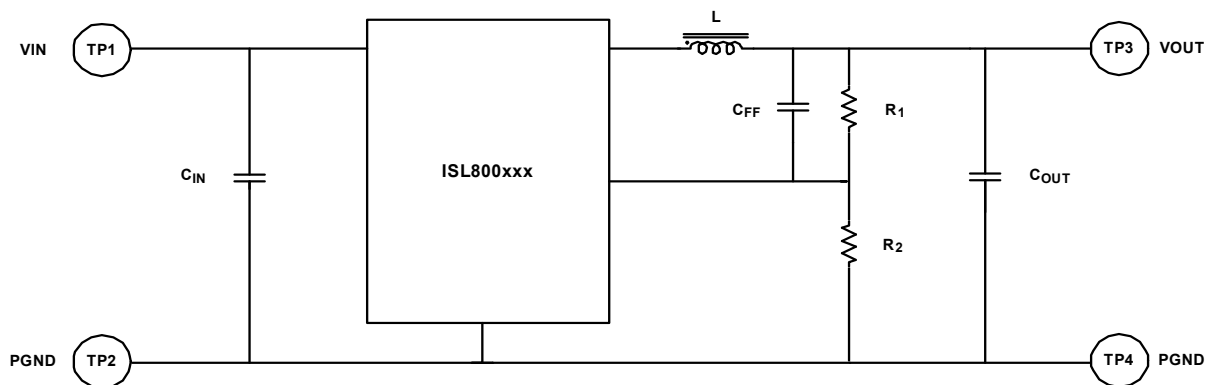

FIGURE 1. BLOCK DIAGRAM

## Test Steps

1. Ensure that the circuit is correctly connected to the supply and loads prior to applying any power.
2. Connect the bias supply to VIN. Plus terminal to VIN (TP1) and negative return to PGND (TP2).
3. Connect the output load to VO (TP3), and the negative return to PGND (TP4).
4. Turn on the power supply.
5. Verify the output voltage is 1.8V for VOUT.

## Functional Description

The ISL800xxxDEM01Z boards provide a simple platform to evaluate performance of the ISL80020, ISL80020A, ISL80015, and ISL80015A.

These devices are highly efficient, monolithic, synchronous step-down DC/DC converters that can deliver up to 1.5A or 2A of continuous output current from a 2.7V to 5.5V input supply. They use peak current mode control architecture to allow very low duty cycle operation. The devices operate at 1MHz or 2MHz switching frequency, thereby providing superior transient response and allowing for the use of a small inductor.

These devices are configured in PWM (Pulse Width Modulation) for fast transient response, which helps reduce the output noise and RF interference.

## PCB Layout Guidelines

The PCB layout is a very important converter design step to make sure the designed converter works well. The power loop is composed of the output inductor L's, the output capacitor  $C_{OUT}$ , the PHASE's pins, and the PGND pin. It is necessary to make the power loop as small as possible and the connecting traces among them should be direct, short, and wide. The switching node of the converter, the PHASE pins, and the traces connected to the node are very noisy. Therefore, keep the voltage feedback trace away from these noisy traces. The input capacitor should be placed as close as possible to the VIN pin and the ground of the input and output capacitors should be connected as closely as possible. The heat of the IC is mainly dissipated through the thermal pad. Maximizing the copper area connected to the thermal pad is preferable. In addition, a solid ground plane is helpful for better EMI performance. It is recommended to add at least four vias to the ground connection within the pad for the best thermal relief.

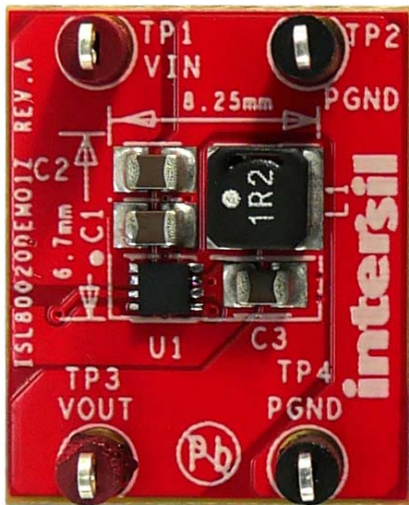
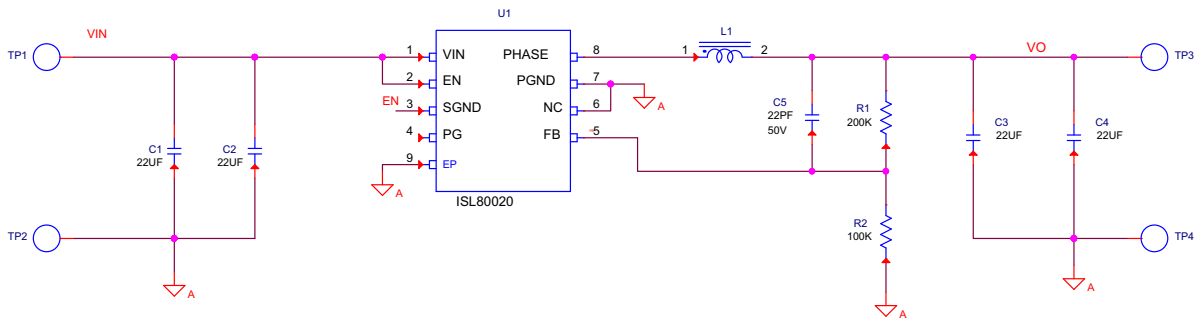

FIGURE 2. ISL80020DEM01Z TOP SIDE



FIGURE 3. ISL80020DEM01Z BOTTOM SIDE

# ISL80020DEMO1Z Schematic



FOR ISL80020 PIN 2 IS EN AND ALWAYS TIE TO VIN. PIN 3 IS SGND POPULATE R8=0OHM TO TIE PIN 3 TO GROUND.

FOR ISL80030 PIN 2 IS VIN. PIN 3 IS EN WILL CONNECT R7=100KOHMS; R8 IS OPEN.

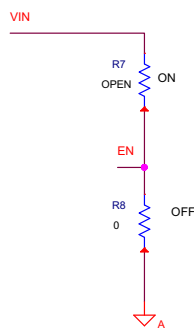

FIGURE 4. ISL80020DEMO1Z SCHEMATIC

## Bill of Materials

MANUFACTURER PART	QTY	UNITS	REFERENCE DESIGNATOR	DESCRIPTION	MANUFACTURER
C2012X5R0J226M	4	ea	C1-C4	CAP, SMD, 0805, 22µF, 6.3V, 20%, X5R, ROHS	TDK
GRM36COG220J050AQ	1	ea	C5	CAP, SMD, 0402, 22pF, 50V, 5%, NP0, ROHS	Murata
74437324012 (ISL80020ADEMO1Z) 74437324022 (ISL80020DEMO1Z) 74437324012 (ISL80015ADEMO1Z) 74437324022 (ISL80015DEMO1Z)	1	ea	L1	COIL-PWR INDUCTOR, WW, SMD, 4mm, ROHS	Würth Electronics
5000	2	ea	TP1, TP3	CONN-MINI TEST PT, VERTICAL, RED, ROHS	Keystone
5001	2	ea	TP2, TP4	CONN-MINI TEST PT, VERTICAL, BLK, ROHS	Keystone
ISL80020AIRZ (ISL80020ADEMO1Z) ISL80020IRZ (ISL80020DEMO1Z) ISL80015IRZ (ISL80015DEMO1Z) ISL80015AIRZ (ISL80015ADEMO1Z)	1	ea	U1	IC-2A, 2MHz BUCK REGULATOR, 8P, TDFN, 2X2, ROHS IC-2A, 1MHz BUCK REGULATOR, 8P, TDFN, 2X2, ROHS IC-1.5A, 1MHz BUCK REGULATOR, 8P, TDFN, 2X2, ROHS IC-1.5A, 2MHz BUCK REGULATOR, 8P, TDFN, 2X2, ROHS	Intersil
ERJ2RKF1003	1	ea	R2	RES, SMD, 0402, 100k, 1/16W, 1%, TF, ROHS	Panasonic
MCR01MZPF2003	1	ea	R1	RES, SMD, 0402, 200k, 1/16W, 1%, TF, ROHS	Rohm
	0	ea	R7	RES, SMD, 0402, DNP, DNP, DNP, TF, ROHS	
ERJ-3GEY0R00V	1	ea	R8	RES, SMD, 0603, 0Ω, 1/16W, TF, ROHS	Panasonic

# Board Layout

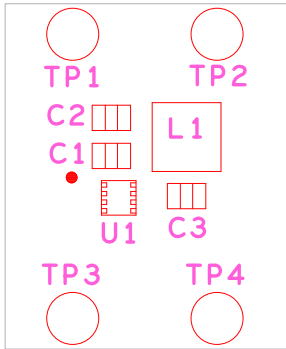

FIGURE 5. SILKSCREEN TOP

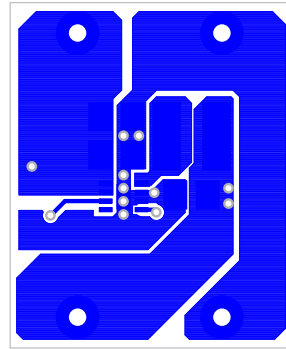

FIGURE 6. LAYER 1

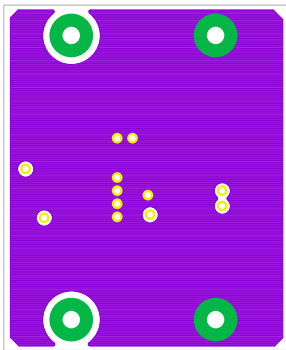

FIGURE 7. LAYER 2

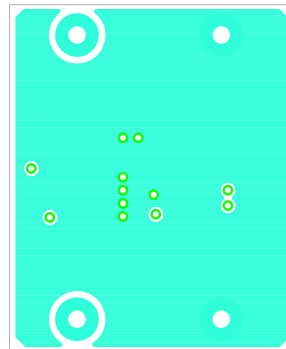

FIGURE 8. LAYER 3

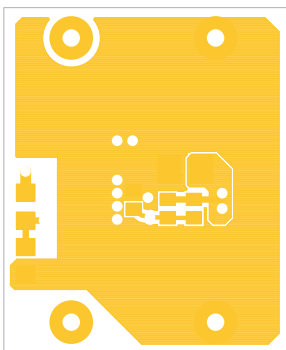

FIGURE 9. LAYER 4

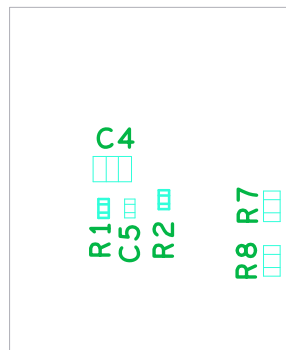

FIGURE 10. SILKSCREEN BOTTOM

## Typical Performance Curves

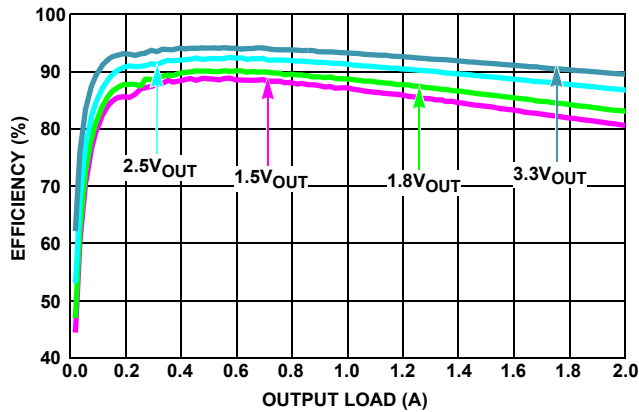

FIGURE 11. EFFICIENCY vs LOAD,  $f_{SW} = 2\text{MHz}$ ,  $V_{IN} = 5\text{V}$ ,  $T_A = +25^\circ\text{C}$

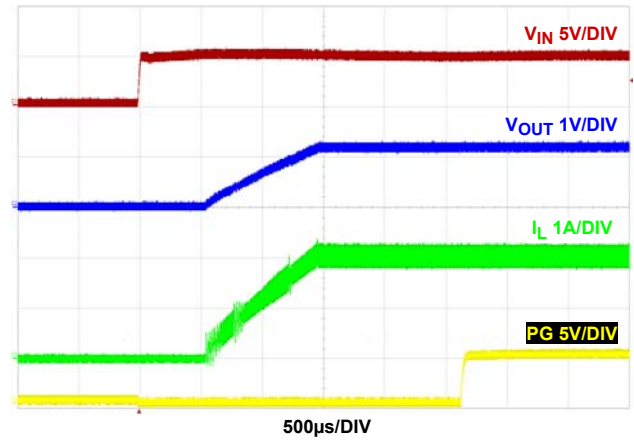

FIGURE 12. START-UP  $V_{IN}$  AT 2A LOAD,  $f_{SW} = 2\text{MHz}$ ,  $V_{IN} = 5\text{V}$ ,  $T_A = +25^\circ\text{C}$

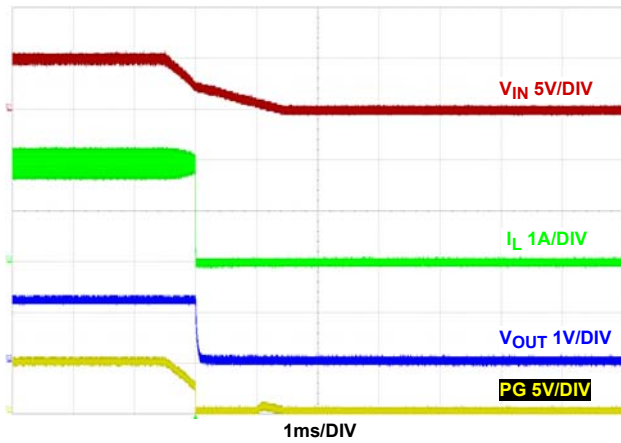

FIGURE 13. SHUTDOWN  $V_{IN}$  AT 2A LOAD,  $f_{SW} = 2\text{MHz}$ ,  $V_{IN} = 5\text{V}$ ,  $T_A = +25^\circ\text{C}$

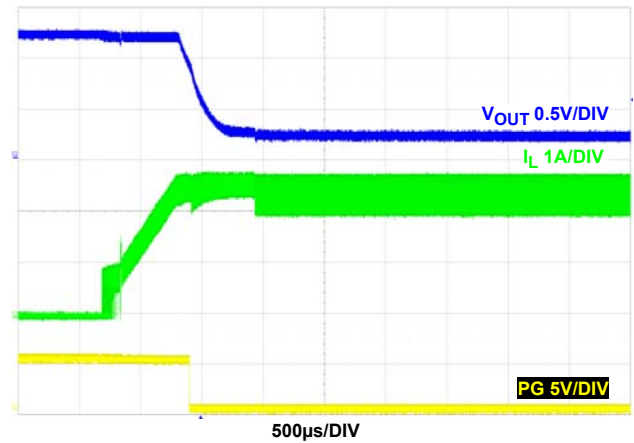

FIGURE 14. OVERCURRENT PROTECTION,  $f_{SW} = 2\text{MHz}$ ,  $V_{IN} = 5\text{V}$ ,  $T_A = +25^\circ\text{C}$

Intersil Corporation reserves the right to make changes in circuit design, software and/or specifications at any time without notice. Accordingly, the reader is cautioned to verify that the document is current before proceeding.

For information regarding Intersil Corporation and its products, see [www.intersil.com](http://www.intersil.com)