

**Product number FA11208_TINA-RS**

Family	Tina	FWHM	15 degrees
Type	Assembly	Efficiency	88 %
LED	XB-H	cd/lm	10.600
Color	Black	Gerber File	Available
Diameter	16.1 mm		
Height	9.5 mm		
Style	Round		
Optic Material	PMMA		
Holder Material	-		
Fastening	["tape", "pin"]		
Status	Production ready		

**Product number FA11212_TINA-RS**

Family	Tina	FWHM	15 degrees
Type	Assembly	Efficiency	88 %
LED	XB-H	cd/lm	10.300
Color	Black	Gerber File	Available
Diameter	16.1 mm		
Height	9.4 mm		
Style	Round		
Optic Material	PMMA		
Holder Material	-		
Fastening	["pin", "tape"]		
Status	Production ready		

**Product number FA11205_TINA-D**

Family	Tina	FWHM	17 degrees
Type	Assembly	Efficiency	87 %
LED	XB-H	cd/lm	7.300
Color	Black	Gerber File	Available
Diameter	16.1 mm		
Height	9.5 mm		
Style	Round		
Optic Material	PMMA		
Holder Material	-		
Fastening	["tape", "pin"]		
Status	Production ready		

**Product number FA11209_TINA-D**

Family	Tina	FWHM	17 degrees
Type	Assembly	Efficiency	87 %
LED	XB-H	cd/lm	7.500
Color	Black	Gerber File	Available
Diameter	16.1 mm		
Height	9.4 mm		
Style	Round		
Optic Material	PMMA		
Holder Material	-		
Fastening	["tape", "pin"]		
Status	Production ready		

**Product number FA11210_TINA-M**

Family	Tina	FWHM	30 degrees
Type	Assembly	Efficiency	81 %
LED	XB-H	cd/lm	2.300
Color	Black	Gerber File	Available
Diameter	16.1 mm		
Height	9.4 mm		
Style	Round		
Optic Material	PMMA		
Holder Material	-		
Fastening	["pin", "tape"]		
Status	Production ready		

**Product number FA11206_TINA-M**

Family	Tina	FWHM	31 degrees
Type	Assembly	Efficiency	80 %
LED	XB-H	cd/lm	2.300
Color	Black	Gerber File	Available
Diameter	16.1 mm		
Height	9.5 mm		
Style	Round		
Optic Material	PMMA		
Holder Material	-		
Fastening	["pin", "tape"]		
Status	Production ready		

**Product number FA11203_TINA-O**

Family	Tina	FWHM	35+17 degrees
Type	Assembly	Efficiency	83 %
LED	XB-H	cd/lm	3.700
Color	Black	Gerber File	Available
Diameter	16.1 mm		
Height	9.4 mm		
Style	Round		
Optic Material	PMMA		
Holder Material	-		
Fastening	["tape", "pin"]		
Status	Production ready		

**Product number FA11204_TINA-O**

Family	Tina	FWHM	38+16 degrees
Type	Assembly	Efficiency	83 %
LED	XB-H	cd/lm	3.600
Color	Black	Gerber File	Available
Diameter	16.1 mm		
Height	9.5 mm		
Style	Round		
Optic Material	PMMA		
Holder Material	-		
Fastening	["pin", "tape"]		
Status	Production ready		

PRODUCT DATASHEET

Tina series

last update 10/10/2013

**Product number FA11207_TINA-W**

Family	Tina	FWHM	53 degrees
Type	Assembly	Efficiency	87 %
LED	XB-H	cd/lm	1.200
Color	Black	Gerber File	Available
Diameter	16.1 mm		
Height	9.5 mm		
Style	Round		
Optic Material	PMMA		
Holder Material	-		
Fastening	["tape", "pin"]		
Status	Production ready		

Product number FA11211_TINA-W

Family	Tina	FWHM	56 degrees
Type	Assembly	Efficiency	89 %
LED	XB-H	cd/lm	1.000
Color	Black	Gerber File	Available
Diameter	16.1 mm		
Height	9.4 mm		
Style	Round		
Optic Material	PMMA		
Holder Material	-		
Fastening	["pin", "tape"]		
Status	Production ready		

NOTE: The typical divergence will be changed by different color, chip size and chip position tolerance. The typical total divergence is the full angle measured where the luminous intensity is half of the peak value.



PRODUCT DATASHEET

Tina series

last update 10/10/2013

GENERAL INFORMATION

- Product series especially designed & optimized for XB-H series of LEDs.
- Special care taken to make light distribution as uniform as possible.
- Lens material optical grade PMMA with high UV and temperature resistance. Allows use of high current and temperature conditions.

Please find more information about used material from below:

http://ledil.fi/sites/default/files/Documents/Technical/Material/PMMA%20N%20UL94_Yellow%20Card.pdf

<http://ledil.fi/sites/default/files/Documents/Technical/Material/PMMA%20N%20PLEXIGLAS-Datasheet.pdf>

D

C

B

A

4

4

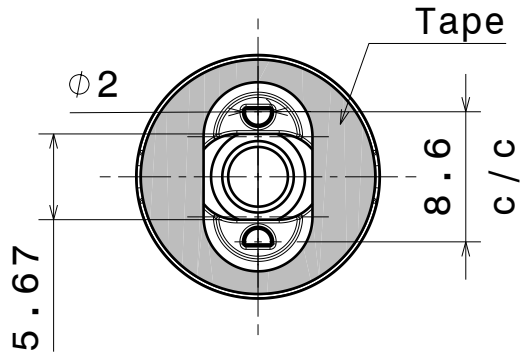

Bottom view

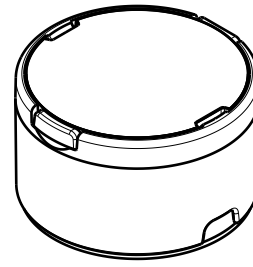

Isometric view

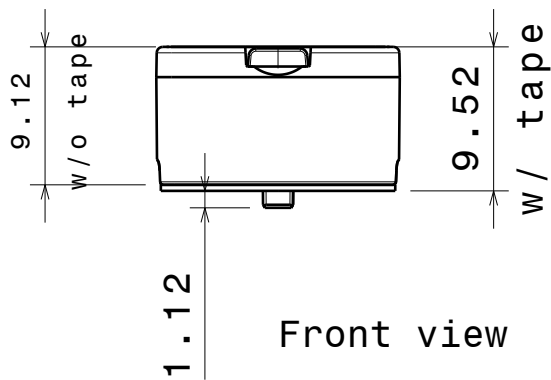

Front view

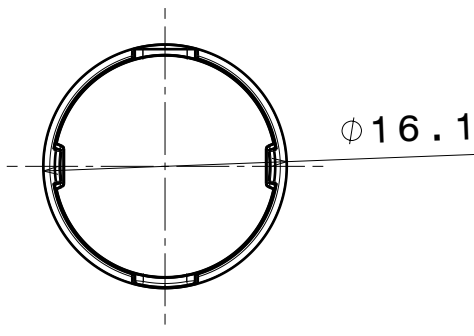

Top view

Materials
 Lens: PMMA
 Holder: PC
 Tape: PU Foam

3

3

2

2

1

1

This drawing is our property.
 It can't be reproduced
 or communicated without
 our written agreement.

LEDiL LediL Oy
 Salorankatu 10
 FIN 24240 SALO
 Finland

DRAWING TITLE Mechanical Drawing

DRAWN BY as
 DATE 10.9.2012

TINA-OSL

CHECKED BY sn
 DATE -

SIZE A4 PART NUMBER TINA-OSL REV 001

DESIGNED BY -
 DATE -

SCALE 2:1 WEIGHT 1,47 g SHEET 1/1

D

A

Luminaire: Ledil Oy FA11208_TINA-RS_(XB-H)

Lamps: 1 x Cree XB-H (XBHAWT-0-3C0-T50-0B-0001) 106lm @ 250mA CCT= P=0.73W I=250mA

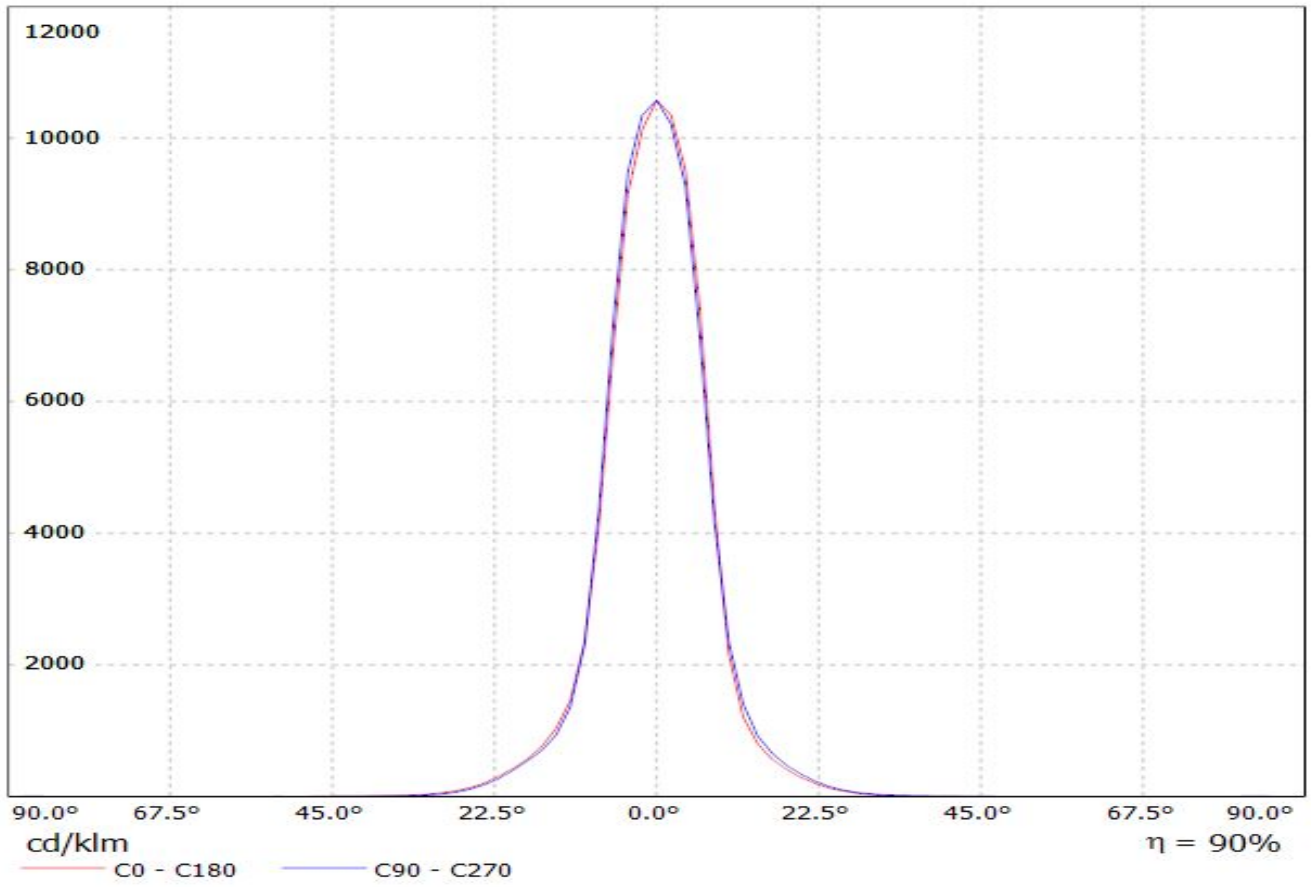

Luminaire: Ledil Oy FA11212_TINA-RS_(XB-H)

Lamps: 1 x Cree XB-H (XBHAWT-0-3C0-T50-0B-0001) 106lm @ 250mA CCT= P=0.73W I=250mA

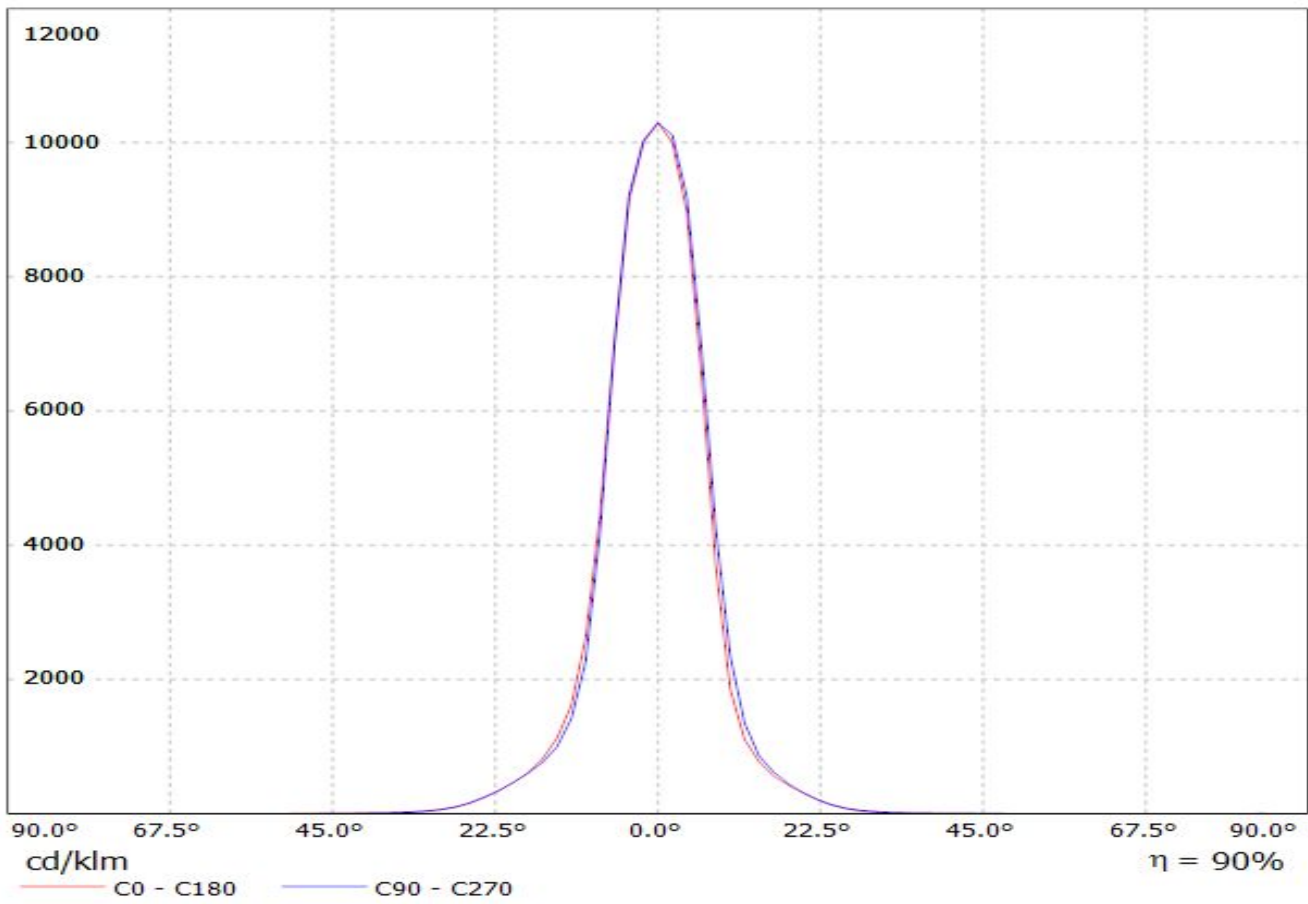

Luminaire: Ledil Oy FA11205_TINA-D_(XB-H)

Lamps: 1 x Cree XB-H (XBHAWT-0-3C0-T50-0B-0001) 106lm @ 250mA CCT= P=0.73W I=250mA

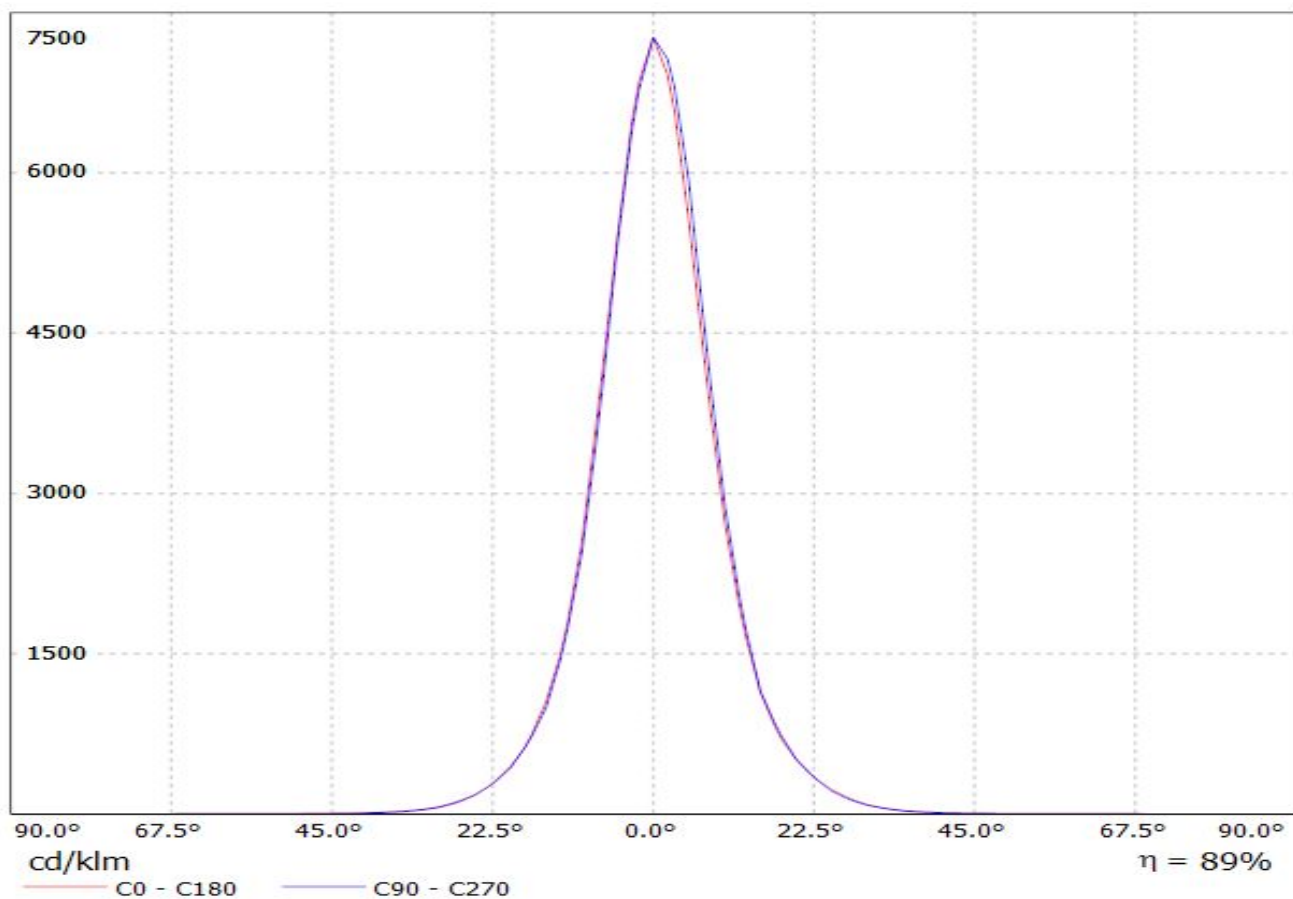

Luminaire: Ledil Oy FA11209_TINA-D_(XB-H)

Lamps: 1 x Cree XB-H (XBHAWT-0-3C0-T50-0B-0001) 106lm @ 250mA CCT= P=0.73W I=250mA

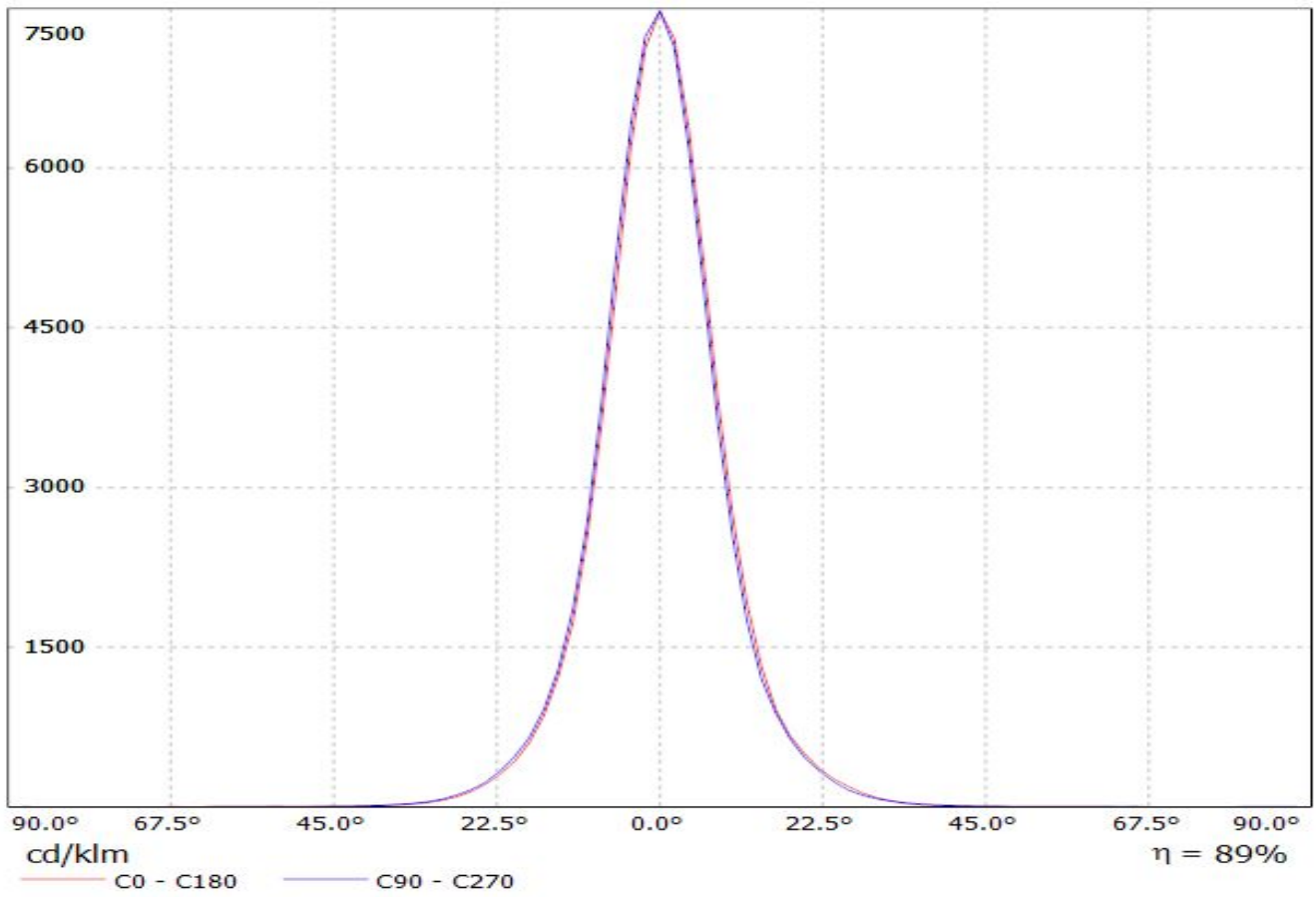

Luminaire: Ledil Oy FA11210_TINA-M_(XB-H)

Lamps: 1 x Cree XB-H (XBHAWT-0-3C0-T50-0B-0001) 106lm @ 250mA CCT= P=0.73W I=250mA

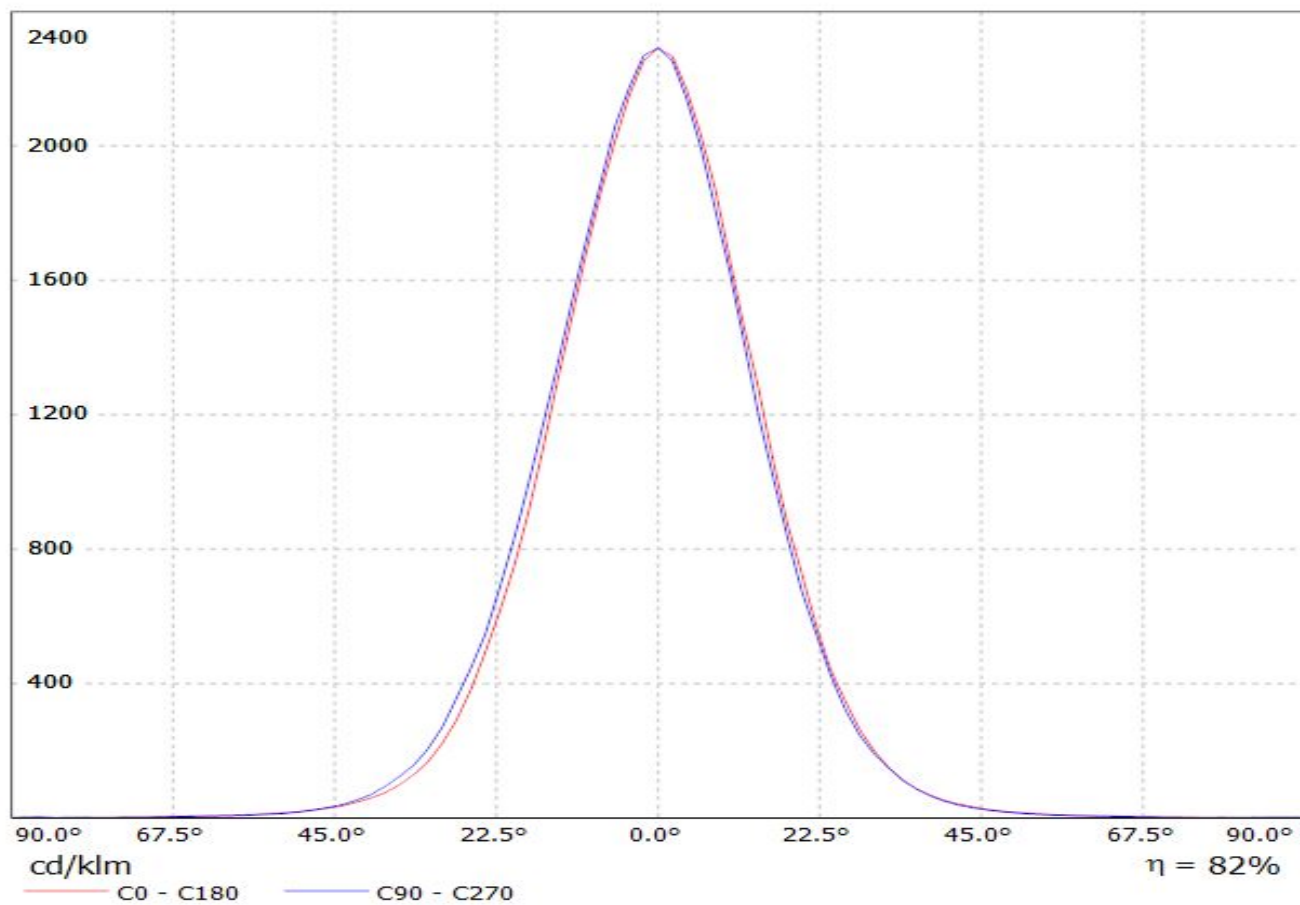

Luminaire: Ledil Oy FA11206_TINA-M_(XB-H)

Lamps: 1 x Cree XB-H (XBHAWT-0-3C0-T50-0B-0001) 106lm @ 250mA CCT= P=0.73W I=250mA

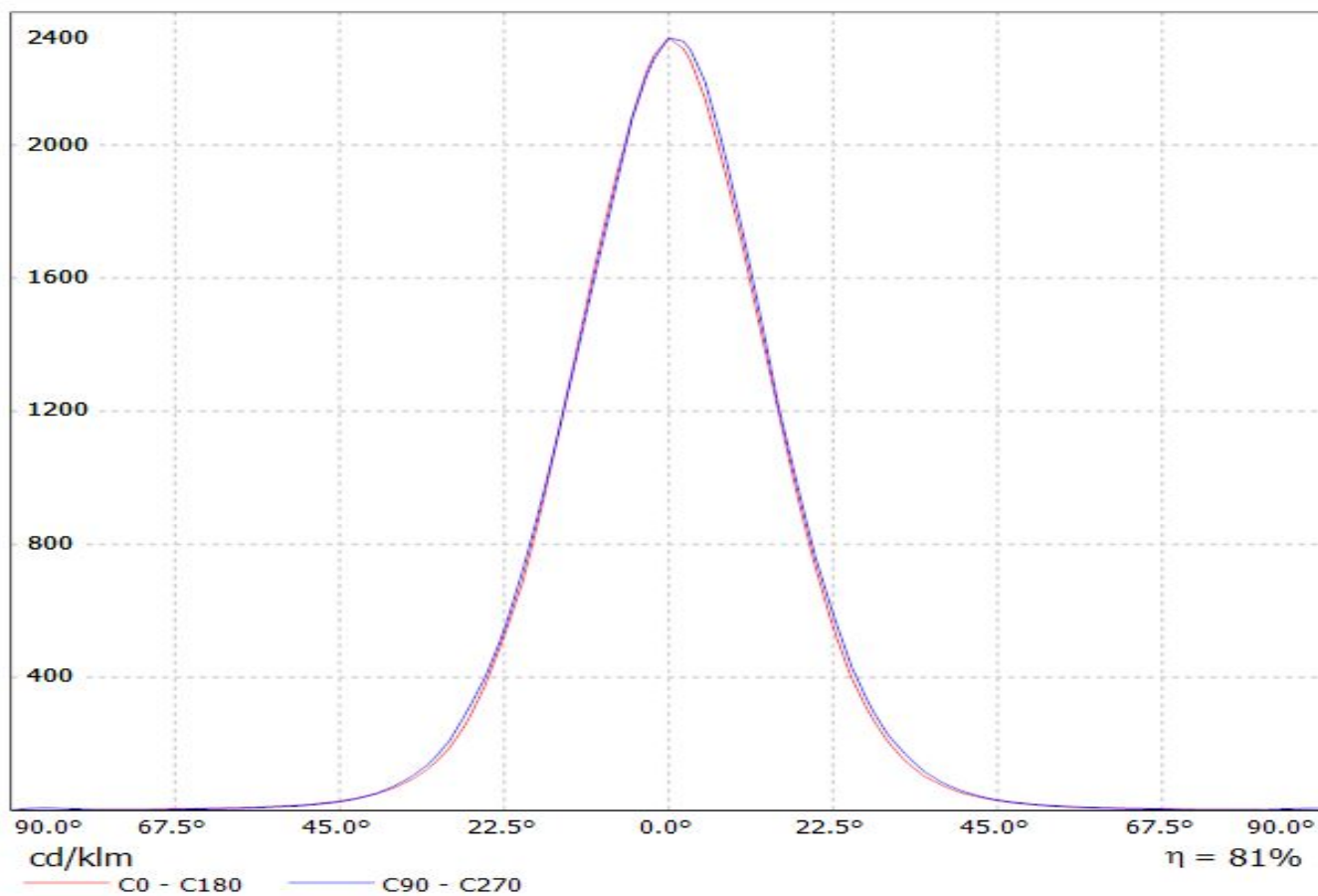

Luminaire: Ledil Oy FA11203_TINA-O_(XB-H)

Lamps: 1 x Cree XB-H (XBHAWT-0-3CO-T50-0B-0001) 106lm @ 250mA CCT= P=0.73W I=250mA

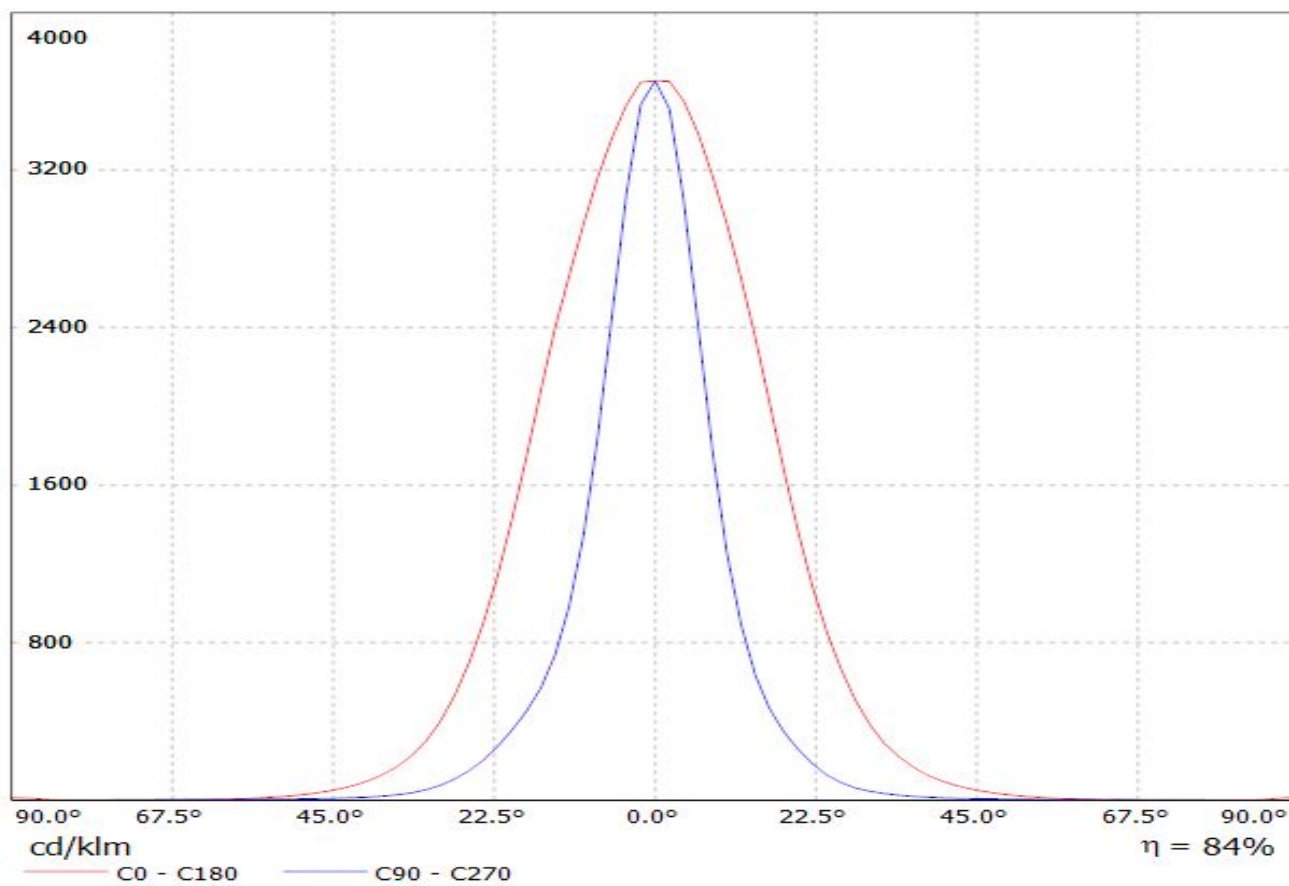

Luminaire: Ledil Oy FA11204_TINA-O_(XB-H)

Lamps: 1 x Cree XB-H (XBHAWT-0-3C0-T50-0B-0001) 106lm @ 250mA CCT= P=0.73W I=250mA

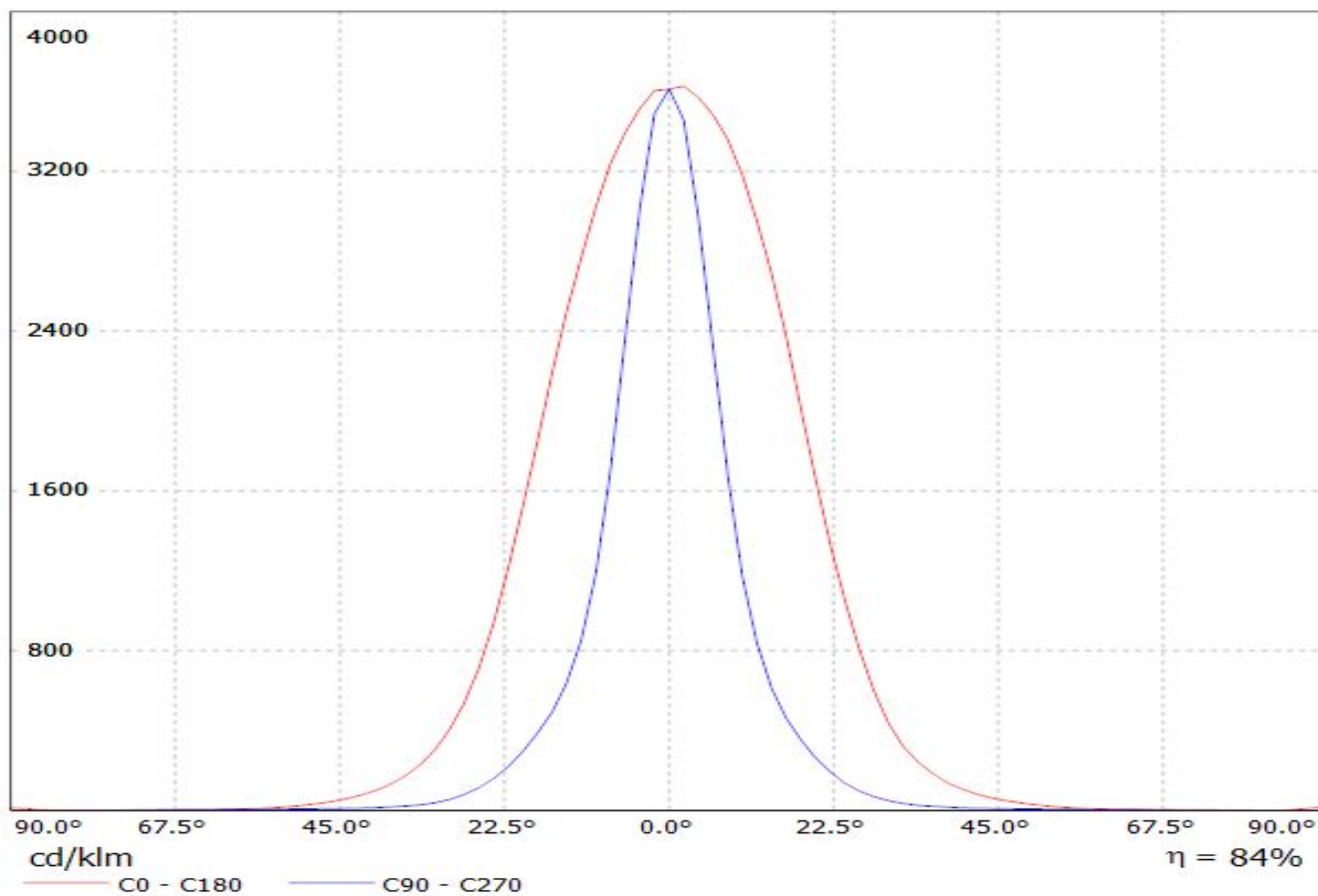

Luminaire: Ledil Oy FA11207_TINA-W_(XB-H)

Lamps: 1 x cree XB-H (XBHAWT-0-3C0-T50-0B-0001) 106lm @ 250mA CCT= P=0.73W I=250mA

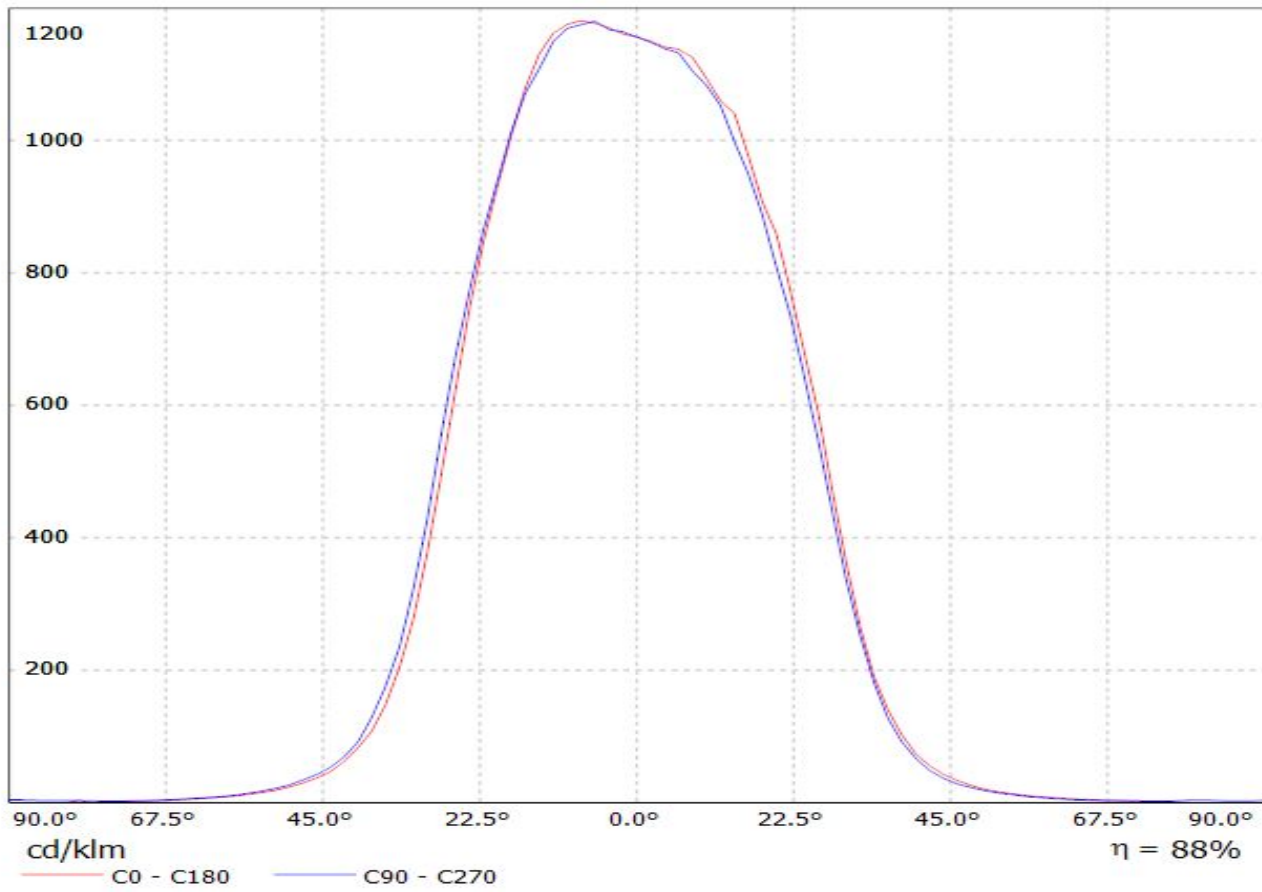

Luminaire: Ledil Oy FA11211_TINA-W_(XB-H)

Lamps: 1 x Cree XB-H (XBHAWT-0-3C0-T50-0B-0001) 106lm @ 250mA CCT= P=0.73W I=250mA

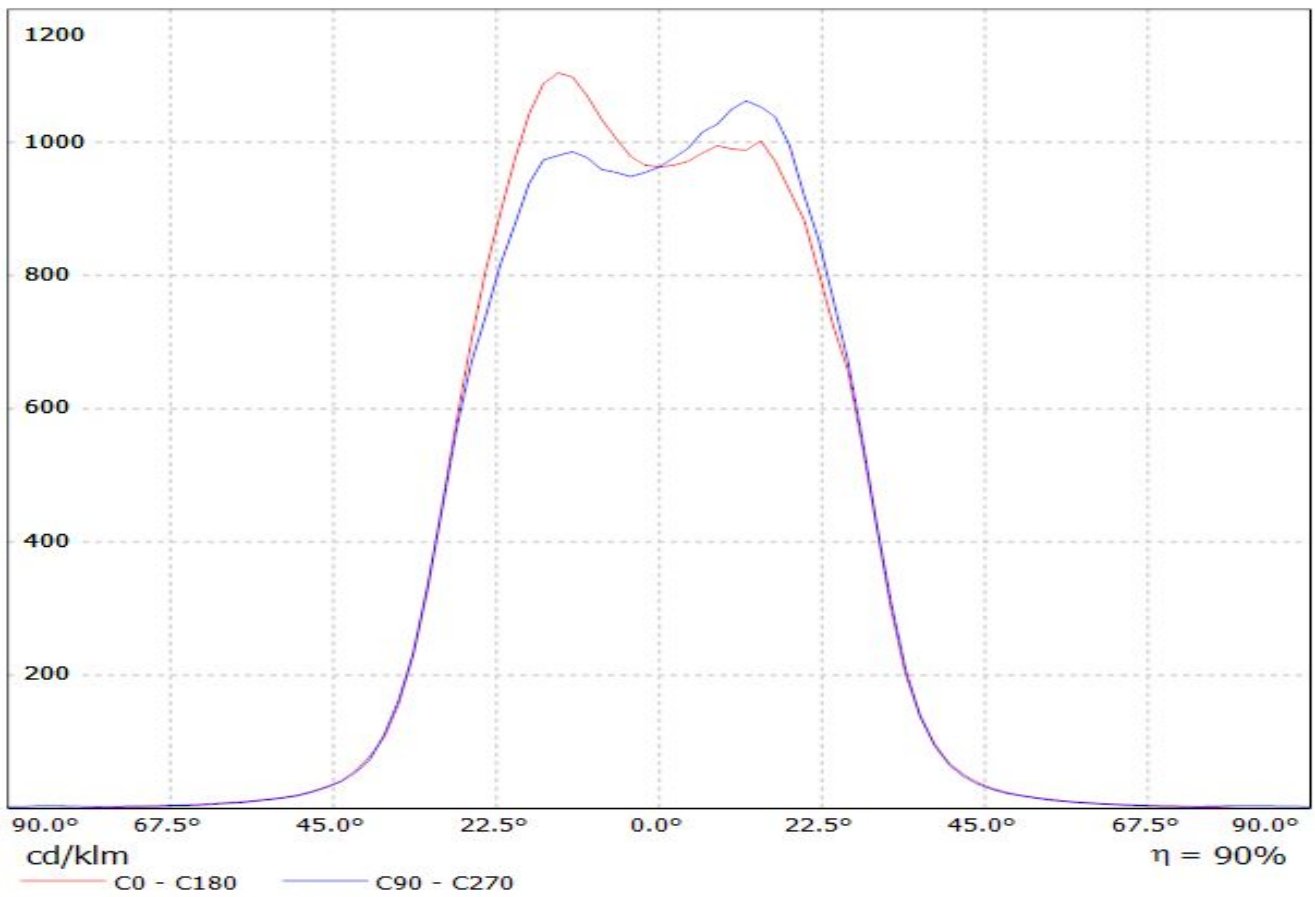

Luminaire: Ledil Oy FA11208_TINA-RS_(XB-H)

Lamps: 1 x Cree XB-H (XBHAWT-0-3C0-T50-0B-0001) 106lm @ 250mA CCT= P=0.73W I=250mA

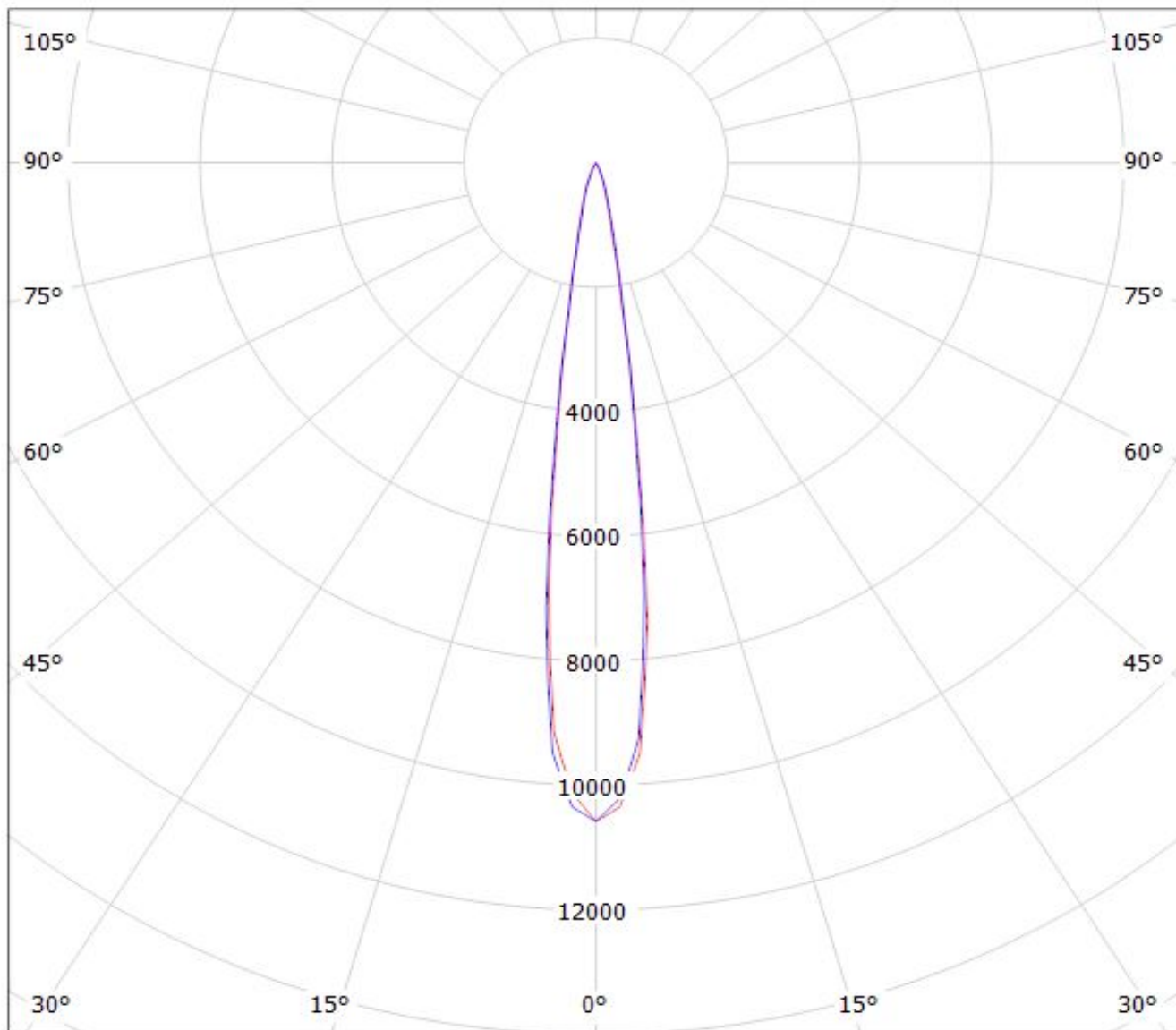

cd/klm

$\eta = 90\%$

— C0 - C180 — C90 - C270

Luminaire: Ledil Oy FA11212_TINA-RS_(XB-H)

Lamps: 1 x Cree XB-H (XBHAWT-0-3C0-T50-0B-0001) 106lm @ 250mA CCT= P=0.73W I=250mA

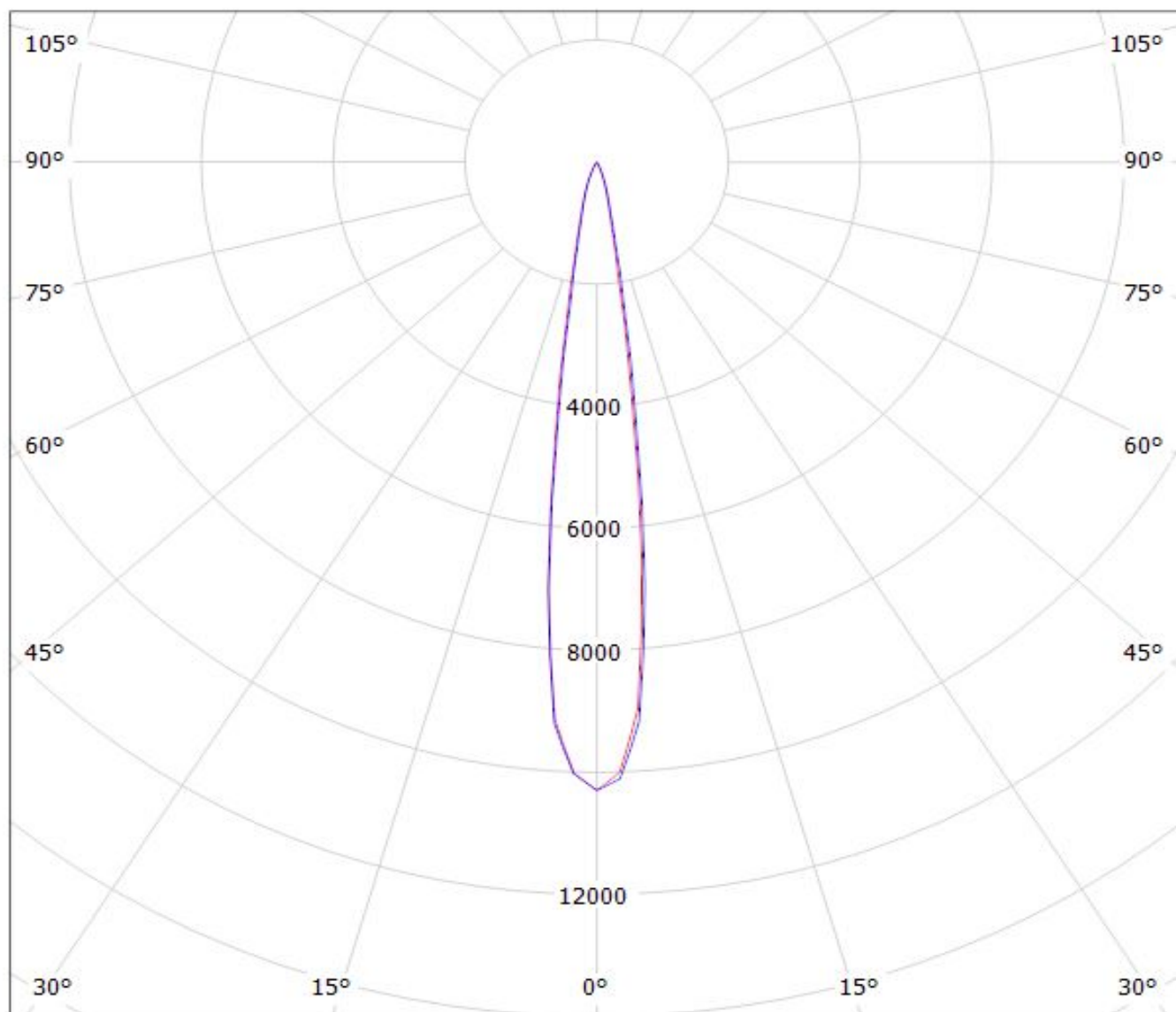

cd/klm

— C0 - C180

— C90 - C270

$\eta = 90\%$

Luminaire: Ledil Oy FA11205_TINA-D_(XB-H)

Lamps: 1 x Cree XB-H (XBHAWT-0-3C0-T50-0B-0001) 106lm @ 250mA CCT= P=0.73W I=250mA

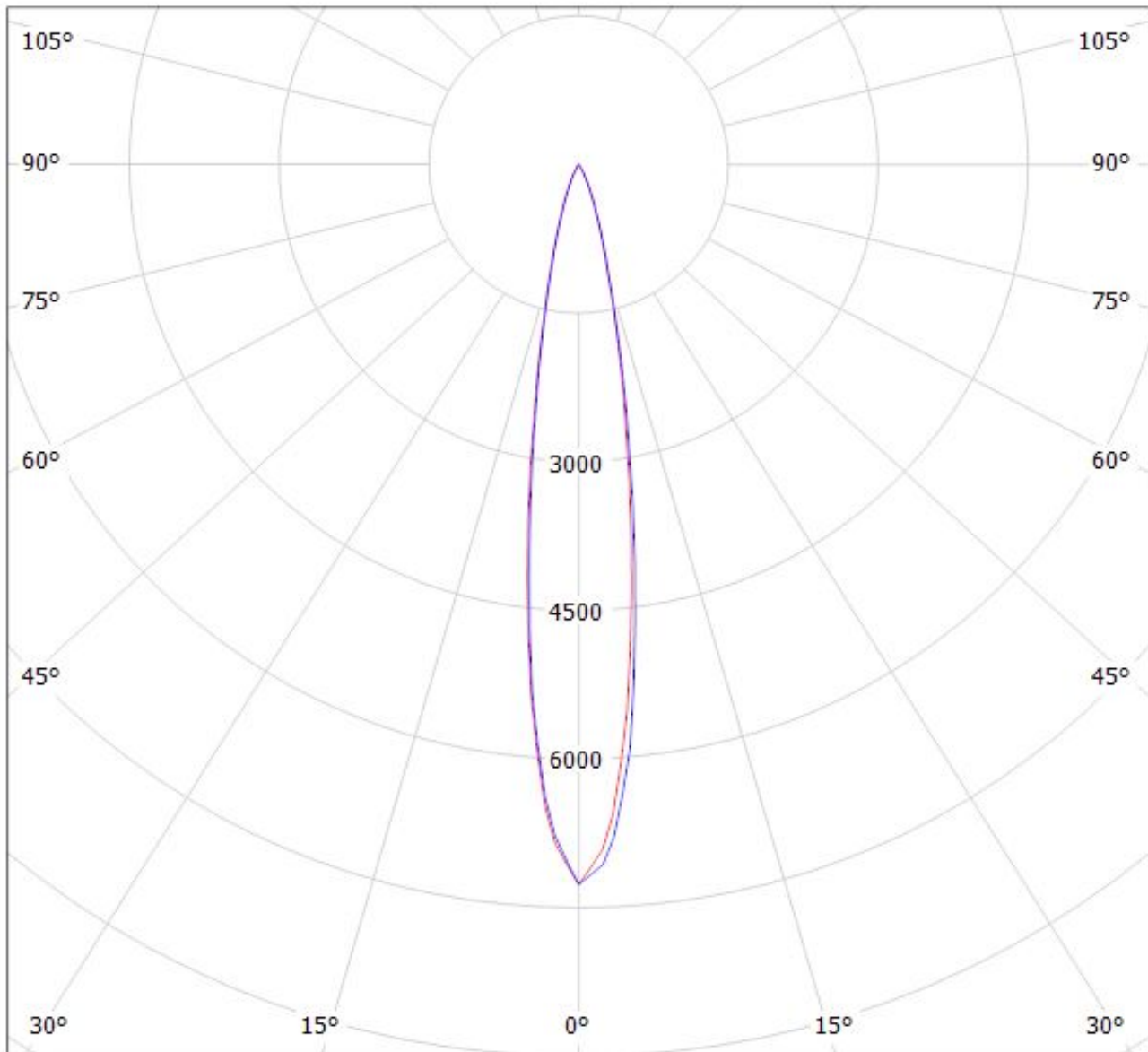

cd/klm

— C0 - C180 — C90 - C270

$\eta = 89\%$

Luminaire: Ledil Oy FA11209_TINA-D_(XB-H)

Lamps: 1 x Cree XB-H (XBHAWT-0-3C0-T50-0B-0001) 106lm @ 250mA CCT= P=0.73W I=250mA

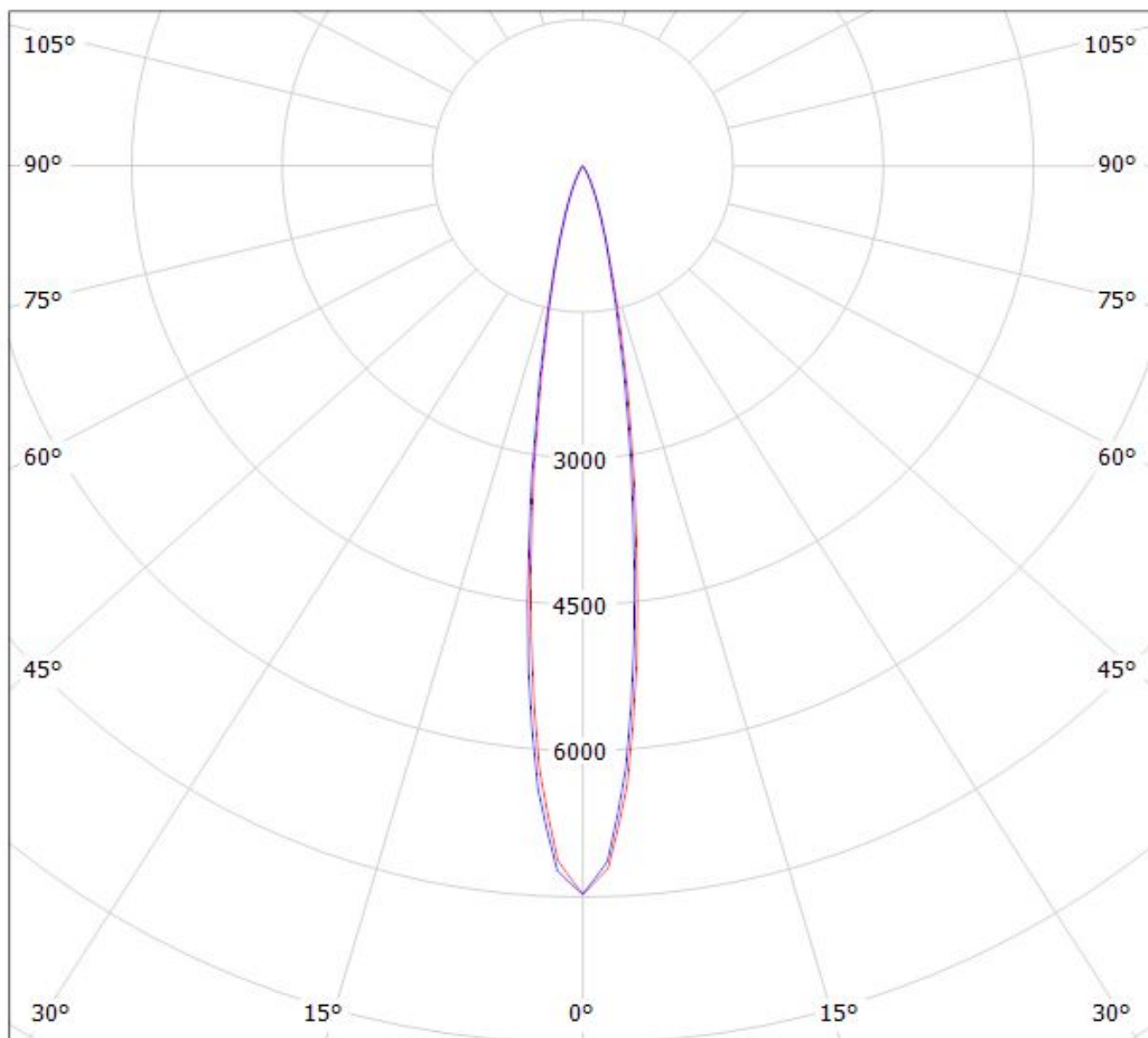

cd/klm

$\eta = 89\%$

— C0 - C180

— C90 - C270

Luminaire: Ledil Oy FA11210_TINA-M_(XB-H)

Lamps: 1 x Cree XB-H (XBHAWT-0-3C0-T50-0B-0001) 106lm @ 250mA CCT= P=0.73W I=250mA

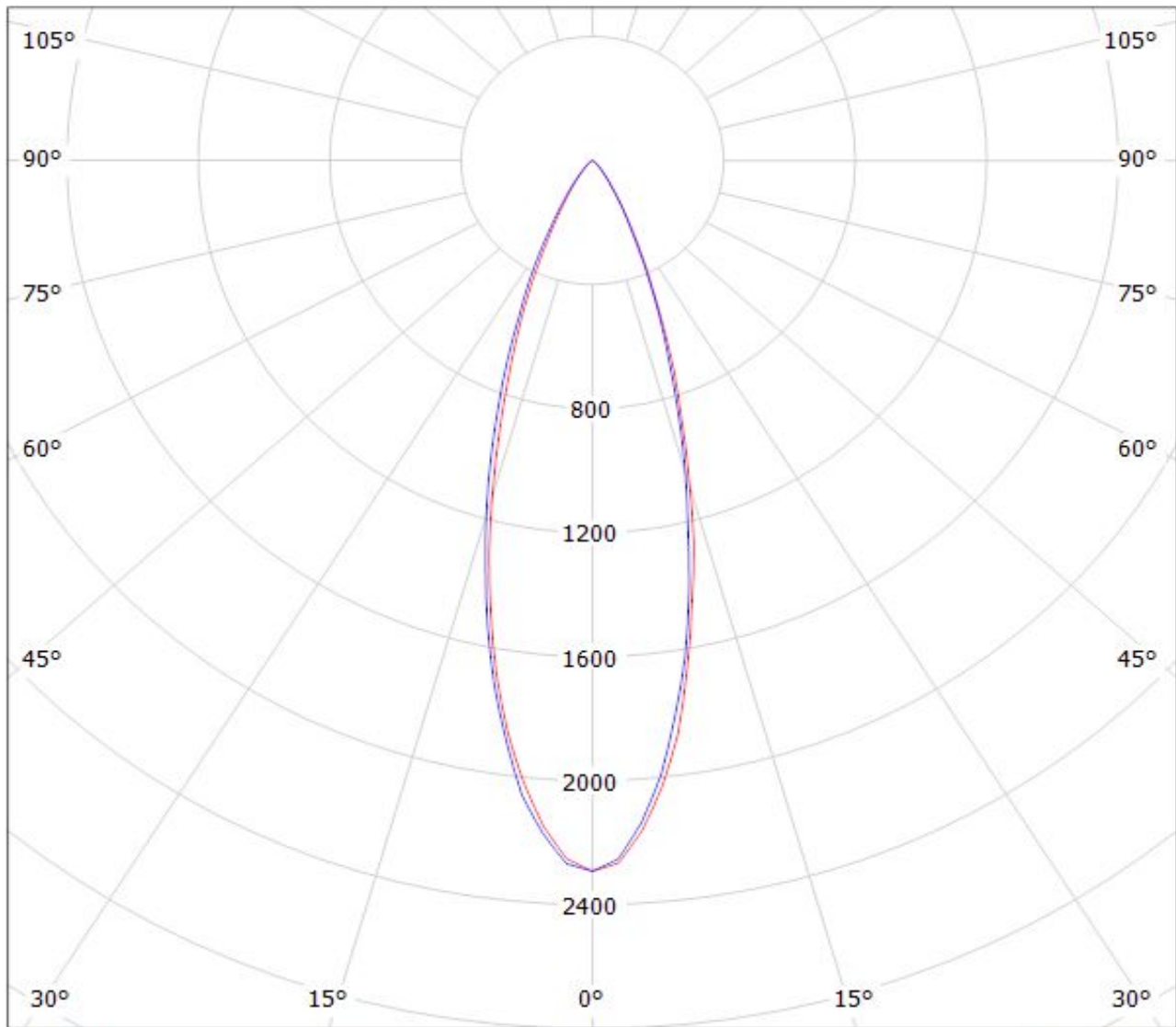

cd/klm

— C0 - C180

— C90 - C270

$\eta = 82\%$

Luminaire: Ledil Oy FA11206_TINA-M_(XB-H)

Lamps: 1 x Cree XB-H (XBHAWT-0-3C0-T50-0B-0001) 106lm @ 250mA CCT= P=0.73W I=250mA

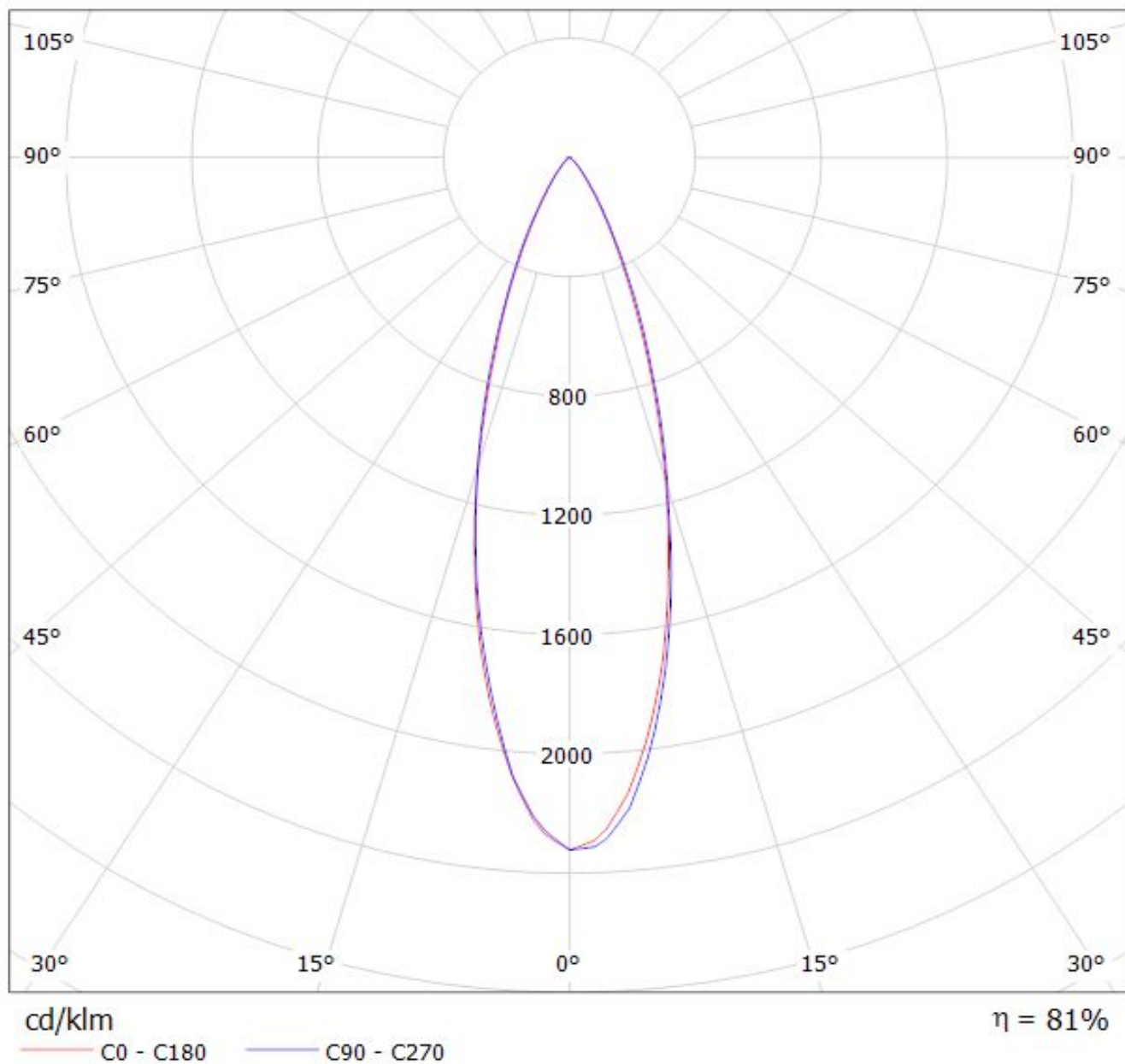

Luminaire: Ledil Oy FA11203_TINA-O_(XB-H)

Lamps: 1 x Cree XB-H (XBHAWT-0-3CO-T50-0B-0001) 106lm @ 250mA CCT= P=0.73W I=250mA

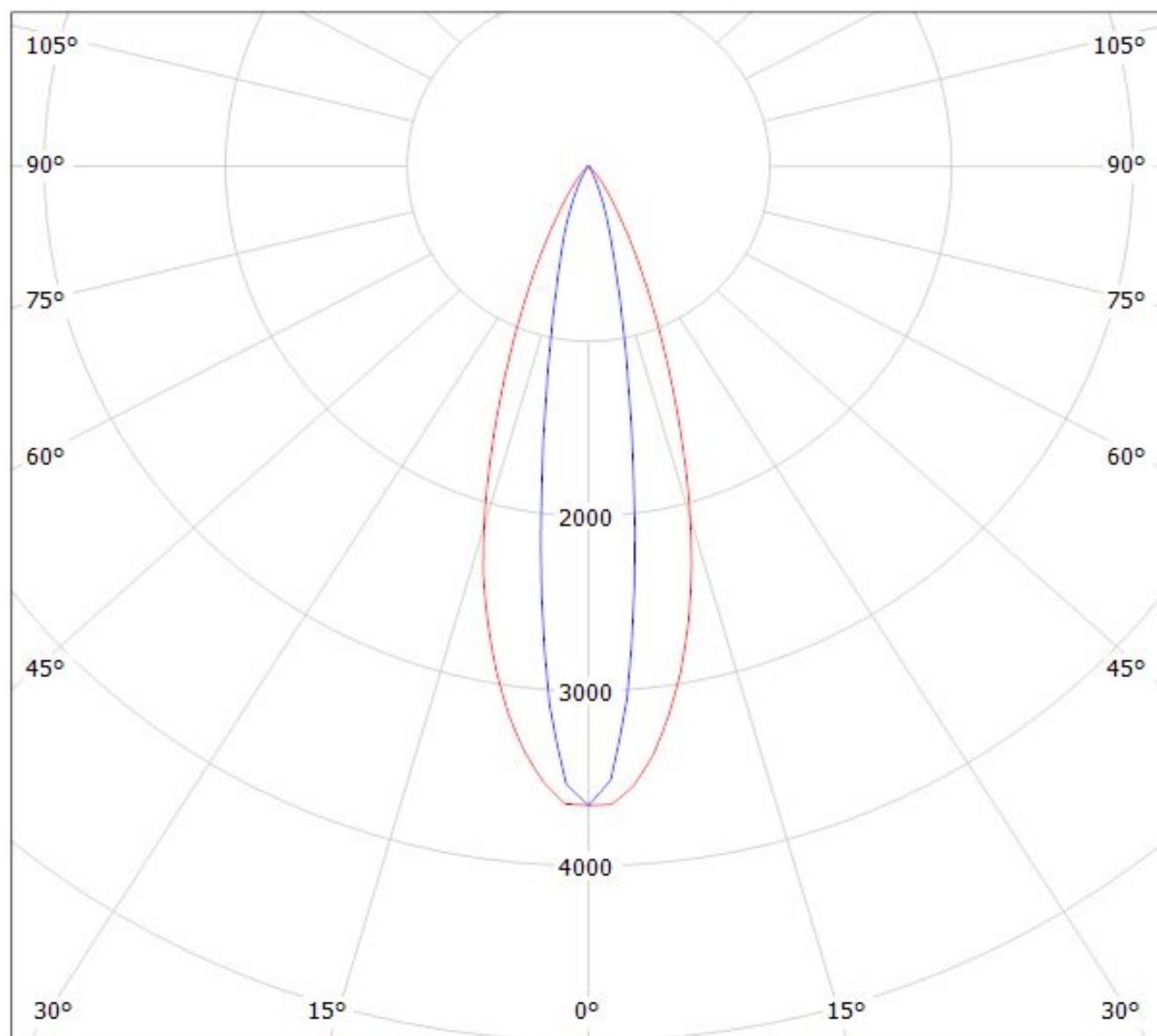

cd/klm

— C0 - C180

— C90 - C270

$\eta = 84\%$

Luminaire: Ledil Oy FA11204_TINA-O_(XB-H)

Lamps: 1 x Cree XB-H (XBHAWT-0-3C0-T50-0B-0001) 106lm @ 250mA CCT= P=0.73W I=250mA

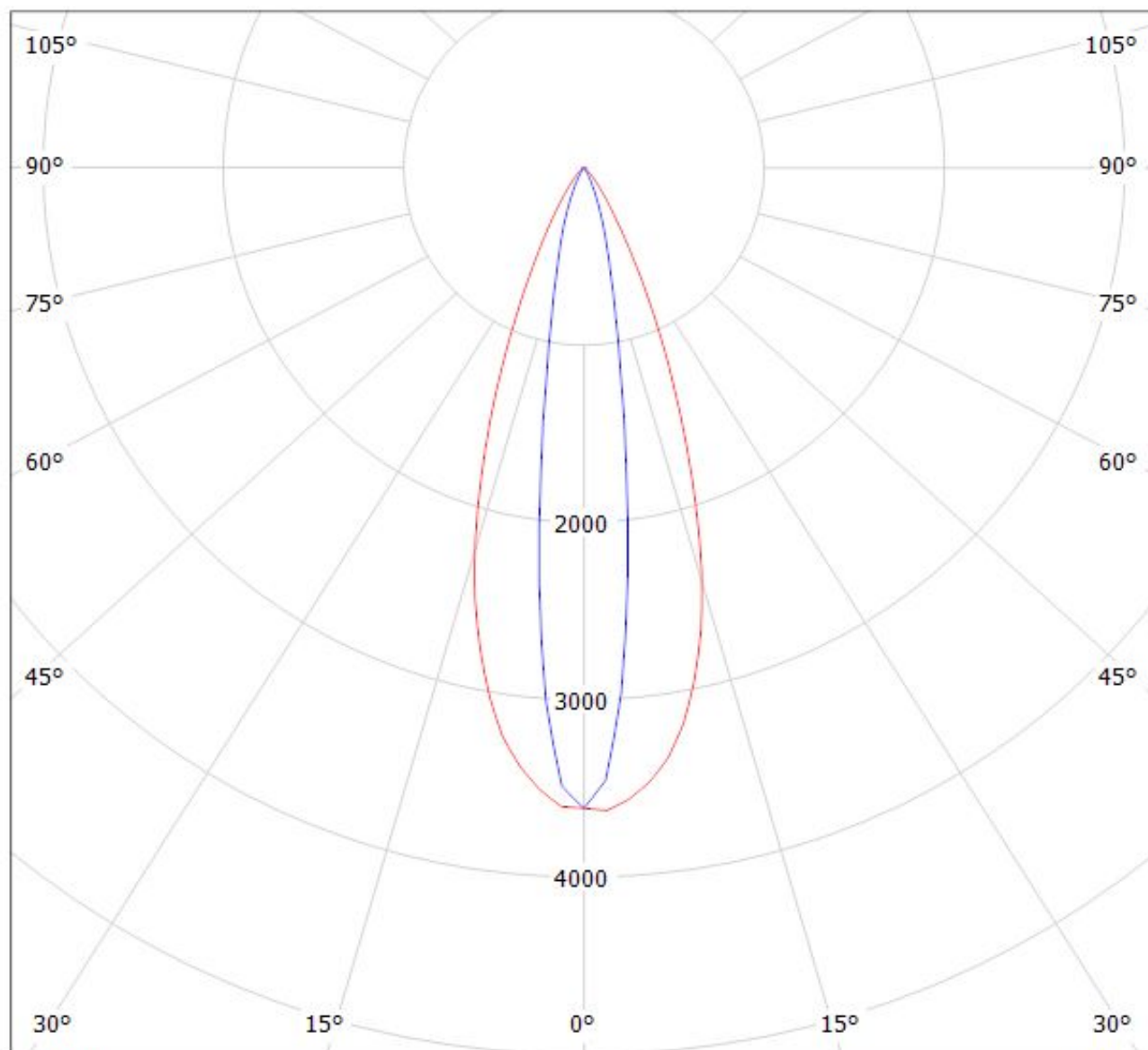

cd/klm

$\eta = 84\%$

— C0 - C180 — C90 - C270

Luminaire: Ledil Oy FA11207_TINA-W_(XB-H)

Lamps: 1 x cree XB-H (XBHAWT-0-3C0-T50-0B-0001) 106lm @ 250mA CCT= P=0.73W I=250mA

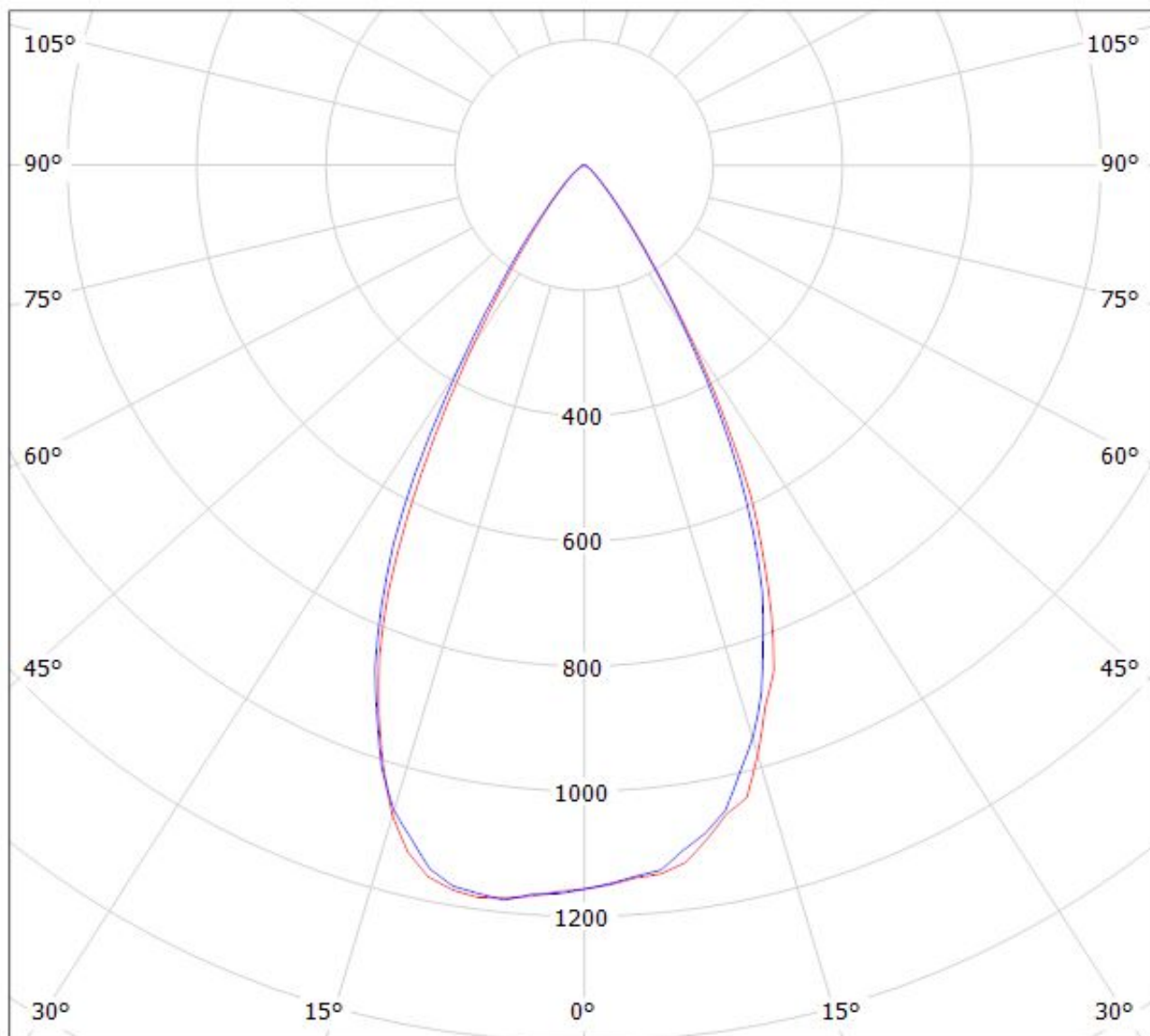

cd/klm

— C0 - C180

— C90 - C270

$\eta = 88\%$

Luminaire: Ledil Oy FA11211_TINA-W_(XB-H)

Lamps: 1 x Cree XB-H (XBHAWT-0-3C0-T50-0B-0001) 106lm @ 250mA CCT= P=0.73W I=250mA

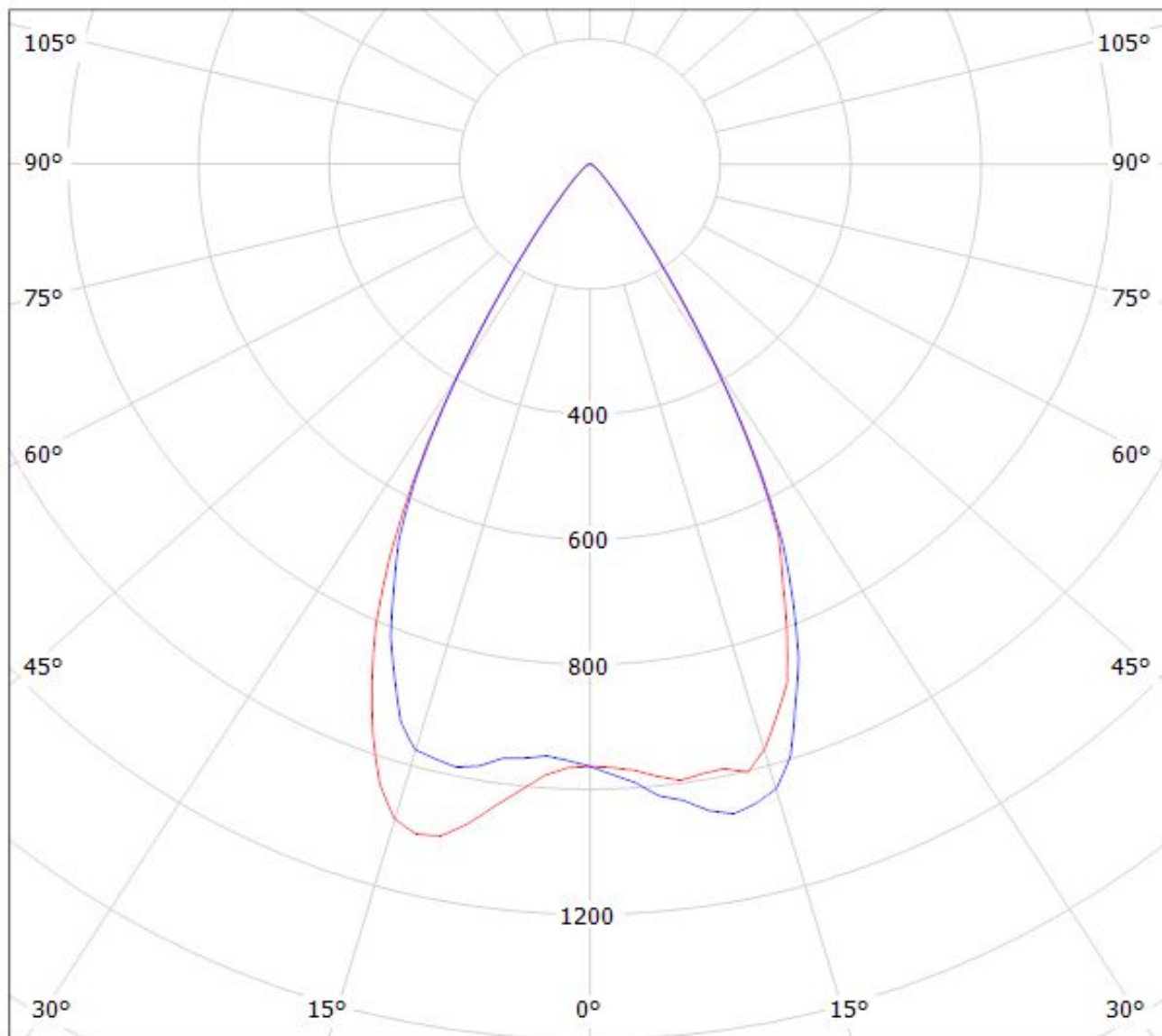

$\eta = 90\%$