

LC026B – CRI80



Introduction

Features

- 26W COB LED : 21.5 x 21.5 x t 1.5 (mm)
- InGaN/GaN MQW LED with long-time reliability
- Lead (Pd) free product - RoHS compliant

Applications

- Spot / Downlighting
- LED Retrofit Bulbs
- Outdoor illumination
- Other applications

SAMSUNG ELECTRONICS

95, Samsung2-Ro, Giheung-Gu,
Yongin-City, Gyeonggi-Do 446-711, KOREA

Copyright © 2013 SAMSUNG ELECTRONICS Co.,Ltd. All rights reserved. The information in this document is subject to change without notice. SAMSUNG,  SAMSUNG is a registered trademark of SAMSUNG ELECTRONICS.

Contents

1. Absolute Maximum Rating	-----	3
2. Characteristics	-----	3
3. Binning Structure	-----	4
4. Chromaticity Coordinates	-----	6
5. Typical Characteristics Graph	-----	8
6. Outline Drawing & Dimension	-----	10
7. Reliability Test Items and Conditions	-----	11
8. Label Structure	-----	12
9. Lot Number	-----	13
10. Tray Dimension	-----	14
11. Aluminum Bag Dimension	-----	14
12. Box & Pad Dimension	-----	15
13. Packing Structure	-----	16
14. Precaution for use	-----	18
15. Revision History	-----	20

1. Absolute Maximum Rating

- 1) Operation Forward Current ($T_a = 25^\circ\text{C}$) 1,300mA
- 2) LED Junction Temperature (T_J) 150°C
- 3) Operating Temperature Range (T_{opr}) $-40^\circ\text{C} \sim 105^\circ\text{C}$
- 4) Storage Temperature Range (T_{stg}) $-40^\circ\text{C} \sim 120^\circ\text{C}$
- 5) Power Dissipation (P_D) 50W

2. Characteristics

- 1) Electro-Optical characteristics ($T_a : 25^\circ\text{C}$)

Item	Unit	Condition	Rank		Min	Typ	Max	
Luminous Flux ¹⁾	lm ²⁾	$I_F = 720 \text{ mA}$	2700K	2F	27	2500	-	2710
					28	2710	-	2920
					29	2920	-	3130
					30	3130	-	3340
			3000K	2F	27	2670	-	2890
					28	2890	-	3110
					29	3110	-	3330
					30	3330	-	3550
			3500K	2F	27	2780	-	3000
					28	3000	-	3220
					29	3220	-	3440
					30	3440	-	3660
			4000K	2F	27	2850	-	3080
					28	3080	-	3310
					29	3310	-	3540
					30	3540	-	3770
			5000K	3F	31	2900	-	3130
					32	3130	-	3360
					33	3360	-	3590
					34	3590	-	3820
Forward Voltage	V ³⁾	$I_F = 720 \text{ mA}$	YH		32.5	35.5	38.5	
CRI ⁴⁾		$I_F = 720 \text{ mA}$	-		80	-	-	
Thermal Resistance ($R_{th,j-c}$)	$^\circ\text{C}/\text{W}$	-	-			0.9		
View Angle	$^\circ$	$I_F = 720 \text{ mA}$	-		-	115 $^\circ$	-	

Note :

- 1) Samsung LED tested in pulsed condition. $T_J=25^\circ\text{C}$, pulse width is 10ms at rated test current.
- 2) Samsung LED has $\pm 7\%$ tolerance of flux measurements.
- 3) Samsung LED has $\pm 5\%$ tolerance of forward voltage measurements.
- 4) Samsung LED has ± 1 tolerance of CRI measurements.

3. Binning Structure

(Condition : $I_F = 720 \text{ mA}$, $T_a : 25^\circ\text{C}$)

1) VF Binning

CCT	Product Code	VF Rank	VF (V)		
			Min	Typ	Max
2700K	SPHWW1HDNC25YHW32F	YH	32.5	35.5	38.5
3000K	SPHWW1HDNC25YHV32F	YH	32.5	35.5	38.5
3500K	SPHWW1HDNC25YHU32F	YH	32.5	35.5	38.5
4000K	SPHWW1HDNC25YHT32F	YH	32.5	35.5	38.5
5000K	SPHCW1HDNC25YHRT3F	YH	32.5	35.5	38.5

2) Color Binning

CCT	Product Code	Color Rank	Chromaticity Bins
2700K	SPHWW1HDNC25YHW32F	W3	WA
3000K	SPHWW1HDNC25YHV32F	V3	VA
3500K	SPHWW1HDNC25YHU32F	U3	UA
4000K	SPHWW1HDNC25YHT32F	T3	TA
5000K	SPHCW1HDNC25YHRT3F	RT	RW, RX, RY, RZ

3) Luminous Flux Binning

CCT	Product Code	Flux Rank	Flux Bin	Range (lm)		
				Min	Typ	Max
2700K	SPHWW1HDNC25YHW3 <u>2F</u>	2F	27	2500	-	2710
			28	2710	-	2920
			29	2920	-	3130
			30	3130	-	3340
3000K	SPHWW1HDNC25YHV3 <u>2F</u>	2F	27	2670	-	2890
			28	2890	-	3110
			29	3110	-	3330
			30	3330	-	3550
3500K	SPHWW1HDNC25YHU3 <u>2F</u>	2F	27	2780	-	3000
			28	3000	-	3220
			29	3220	-	3440
			30	3440	-	3660
4000K	SPHWW1HDNC25YHT3 <u>2F</u>	2F	27	2850	-	3080
			28	3080	-	3310
			29	3310	-	3540
			30	3540	-	3770
5000K	SPHCW1HDNC25YHRT3 <u>3F</u>	3F	31	2900	-	3130
			32	3130	-	3360
			33	3360	-	3590
			34	3590	-	3820

4. Chromaticity Coordinates

(Condition : $I_F = 720 \text{ mA}$, $T_a : 25^\circ\text{C}$)

1) 2700K

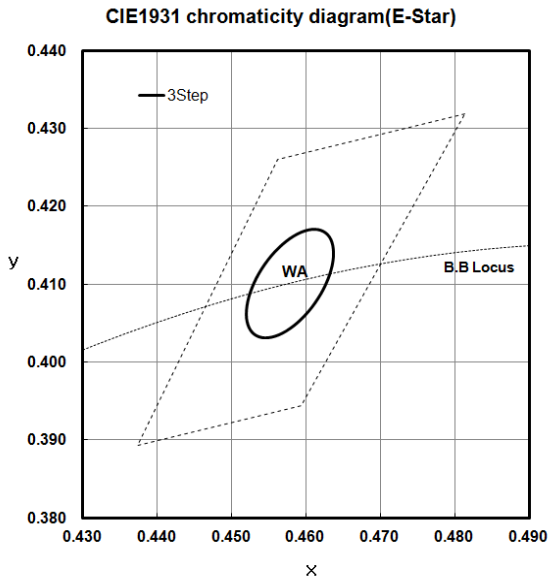

Macadam Ellipse 3step (WA)				
x	y	θ	a	b
0.4578	0.4101	53.7	0.0081	0.0042

2) 3000K

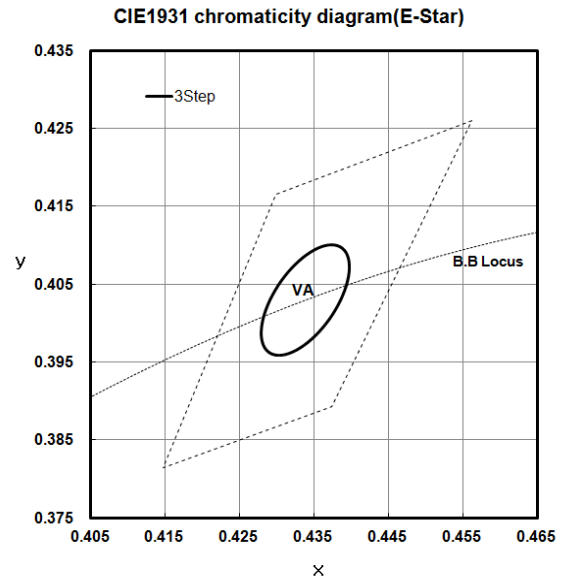

Macadam Ellipse 3step (VA)				
x	y	θ	a	b
0.4338	0.4030	53.22	0.0083	0.0041

3) 3500K

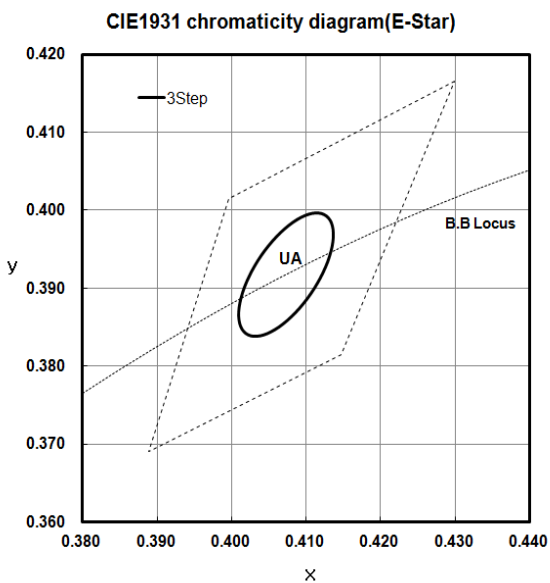

Macadam Ellipse 3step (UA)				
x	y	θ	a	b
0.4073	0.3917	54.0	0.0093	0.0041

4) 4000K

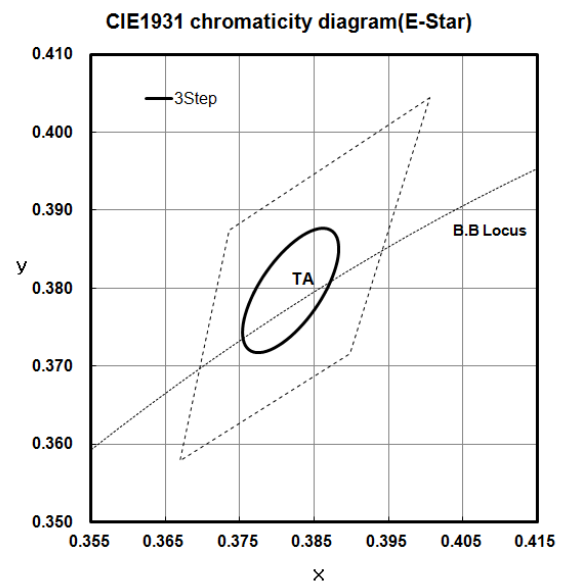

Macadam Ellipse 3step (TA)				
x	y	θ	a	b
0.3818	0.3797	53.72	0.0094	0.0040

5) 5000K

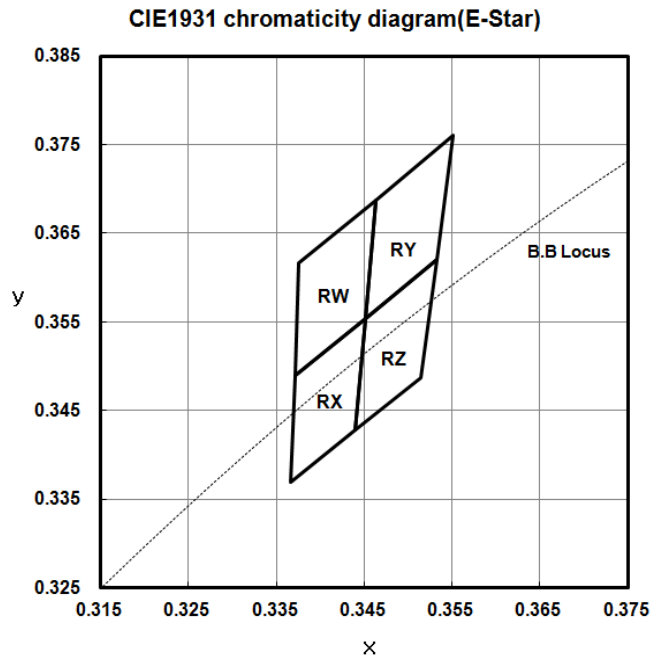

Table	CIE X	CIE Y
RW	0.3376	0.3616
	0.3463	0.3687
	0.3451	0.3554
	0.3371	0.3490
RX	0.3371	0.3490
	0.3451	0.3554
	0.3440	0.3428
	0.3366	0.3369
RY	0.3463	0.3687
	0.3551	0.3760
	0.3533	0.3620
	0.3451	0.3554
RZ	0.3451	0.3554
	0.3533	0.3620
	0.3515	0.3487
	0.3440	0.3428

Note :

- 1) The Chromaticity Coordinates refers to ANSI C78.377-2008
- 2) Samsung LED has ± 0.005 tolerance of chromaticity(x,y).

5. Typical Characteristics Graph

Forward Current vs. Relative Luminous Flux

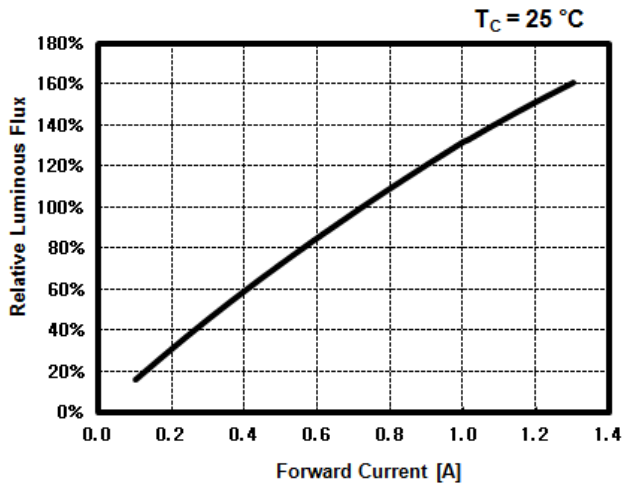

Forward Current vs. Forward Voltage

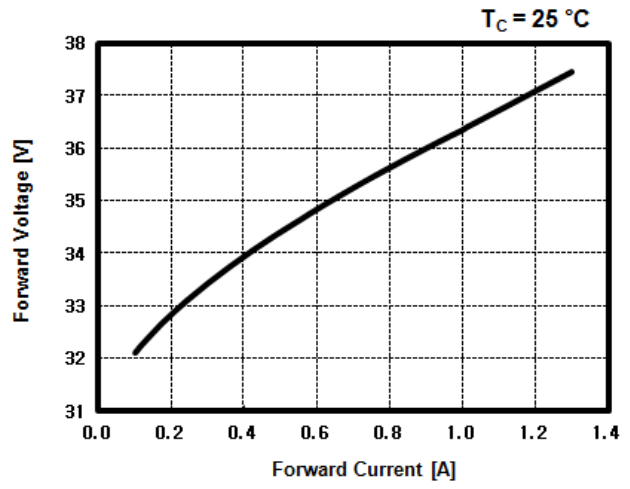

Forward current vs. Chromaticity Coordination

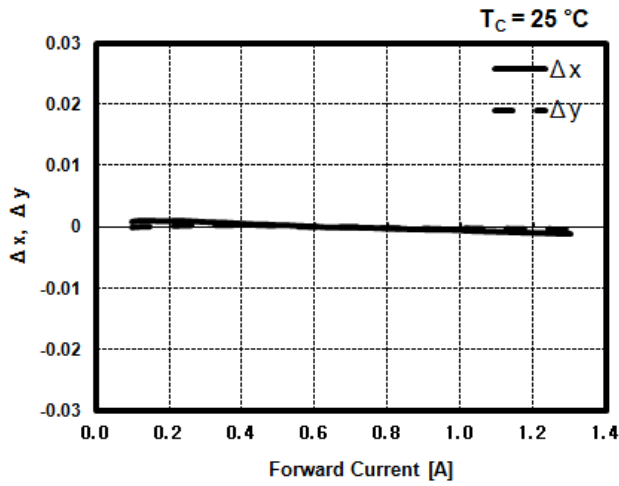

Temperature vs. Chromaticity Coordination

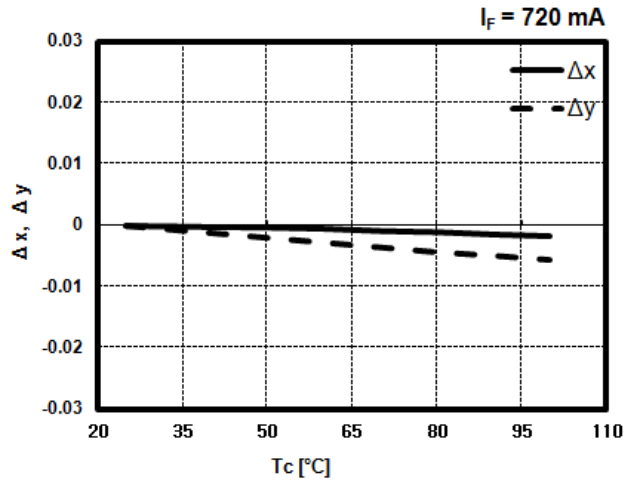

Temperature vs. Voltage

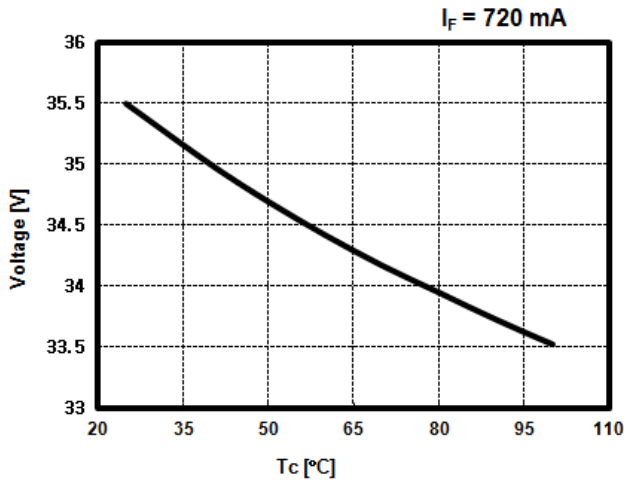

Temperature vs. Relative Luminous Flux

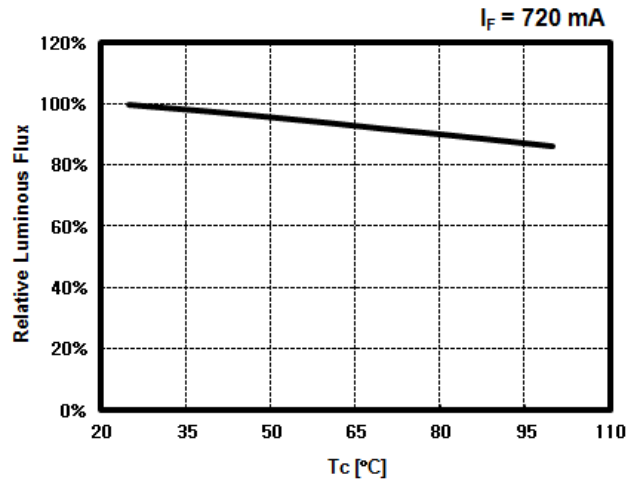

Relative Spectral Emission

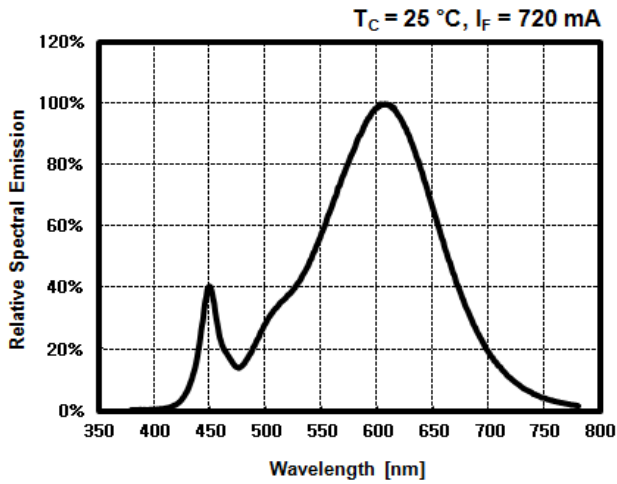

<2700K>

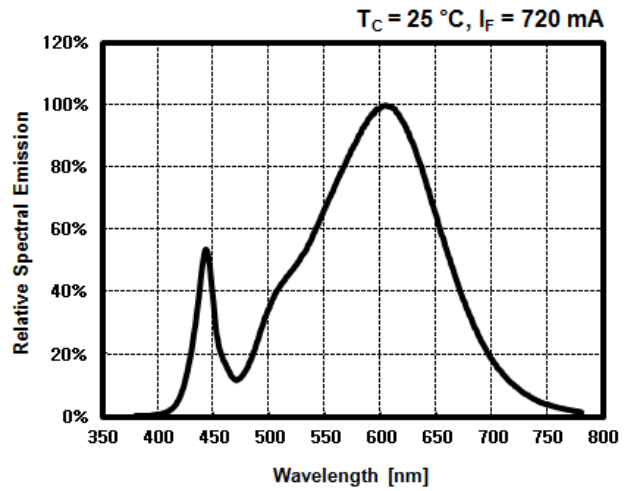

<3000K>

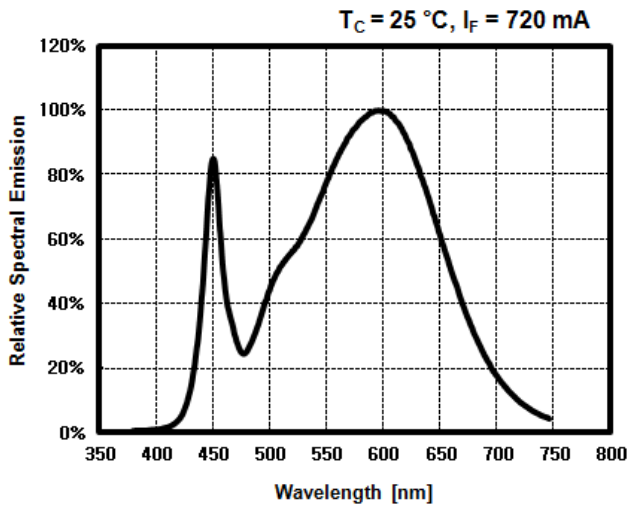

<3500K>

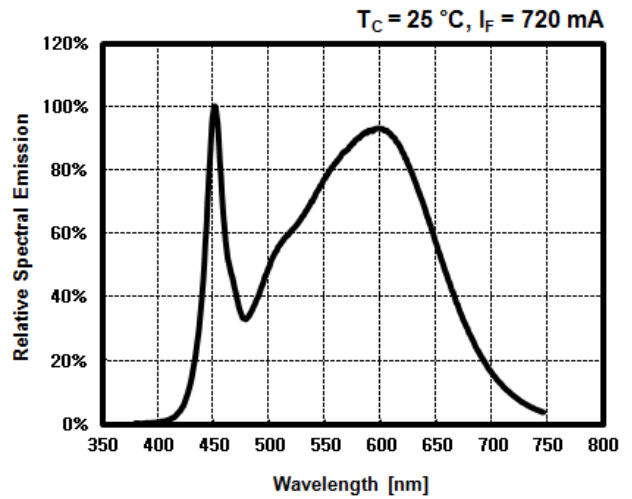

<4000K>

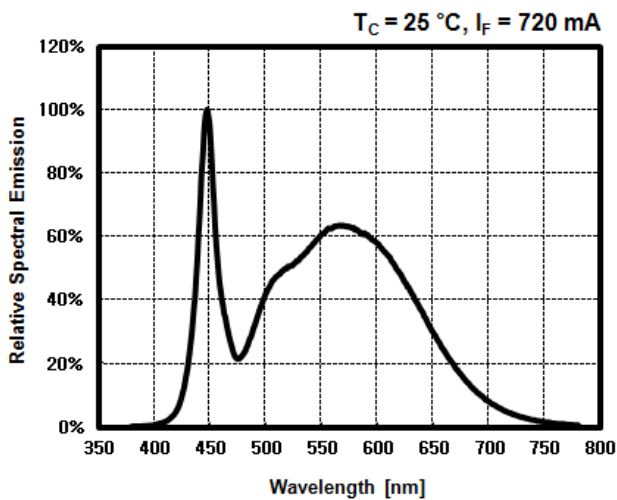

<5000K>

Radiation Pattern

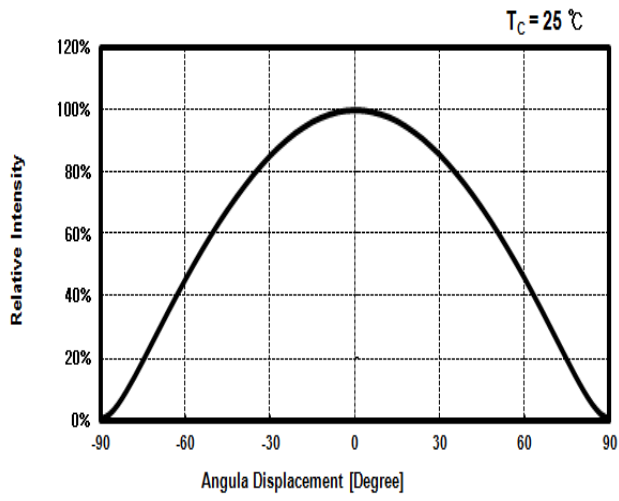

Derating Curve

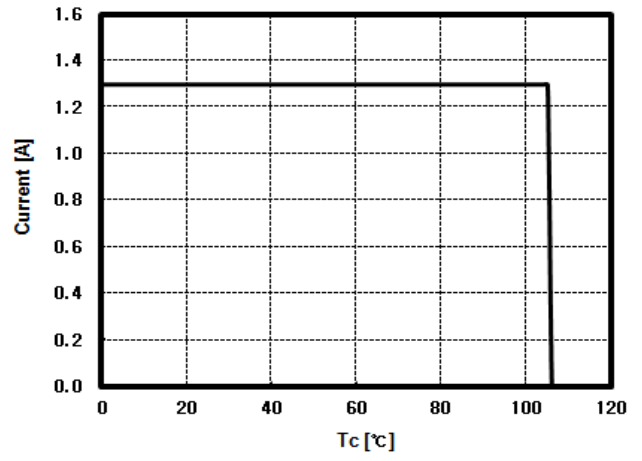

6. Outline Drawing & Dimension

Unit : mm
Tolerance : ± 0.15

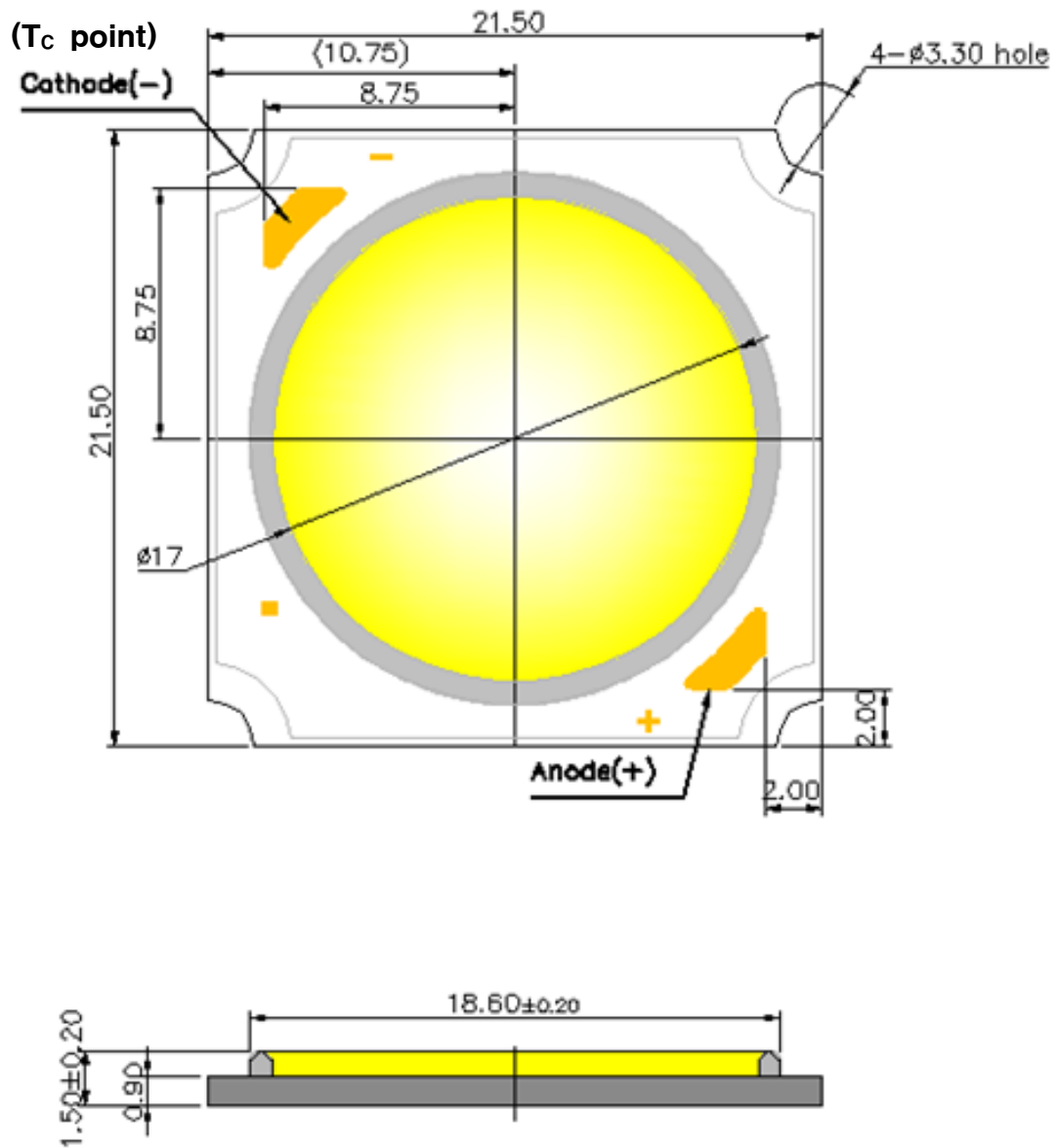

7. Reliability Test Items and Conditions

1) Test Items

Test Items	Test Conditions	Test Hours/Cycles
Room Temperature life test	25°C, I _F = Max	1,000 h
High Temperature humidity life test	85°C, 85% RH, DC Derating I _F = Max	1,000 h
High Temperature life test	105°C, DC Derating I _F = Max	1,000 h
Low Temperature life test	-40°C, DC 1300 mA	1,000 h
High Temperature Storage	120°C	1,000 h
Low Temperature Storage	-40°C	1,000 h
Thermal Shock	-45°C/15min → 125°C/15min Temperature changes in 5min.	200 cycles
Temperature Cycle On/Off test	-40 / 85°C, each 20min, 100min transfer Power On/off each 5min, DC 720 mA	100 cycles
Temperature humidity Cycle Storage	-10°C ↔ 25°C, 95%RH ↔ 85°C, 95%RH [24h/1Cycle]	100 cycles
ESD(HBM)	R1 : 10 MΩ, R2 : 1.5 kΩ, C : 100 pF	5 times (± 5 kV)
ESD(MM)	R1 : 10 MΩ, R2 : 0 kΩ, C : 200 pF	5 times (± 0.5 kV)
Vibration	20~80Hz(Displacement:0.06inch, Max 20G) 80~2kHz (Max 20G) Min. Frequency ↔ Max. Frequency 4min transfer	4 times
Shock	1500G, 0.5ms, Every 6faces (3axis X 2faces)	5 times
Salt Spray	35°C, salt water 5% 8h spray → 16h leaving alone	2 cycles

2) Criteria for Failure

Item	Symbol	Test Condition [T _a = 25°C]	Limit	
			Min.	Max.
Forward Voltage	V _F	1300 mA	L.S.L. × 0.9	U.S.L. × 1.1
Luminous flux	Im	1300 mA	L.S.L. × 0.7	U.S.L. × 1.3

* U.S.L. : Upper Standard Level L.S.L. : Lower Standard Level

8. Label Structure

* Bag & Inner box

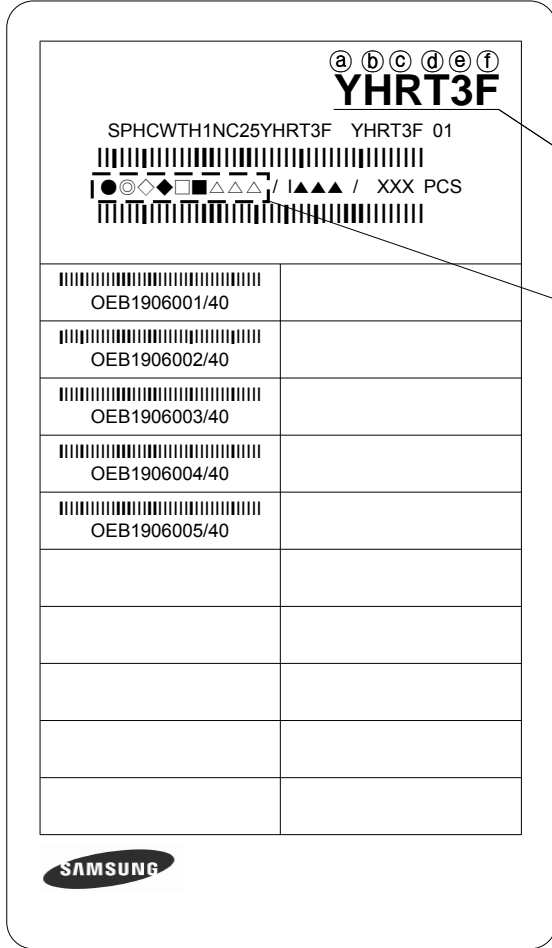

Rank Code

Lot number

Tray number /Q'ty

* Box

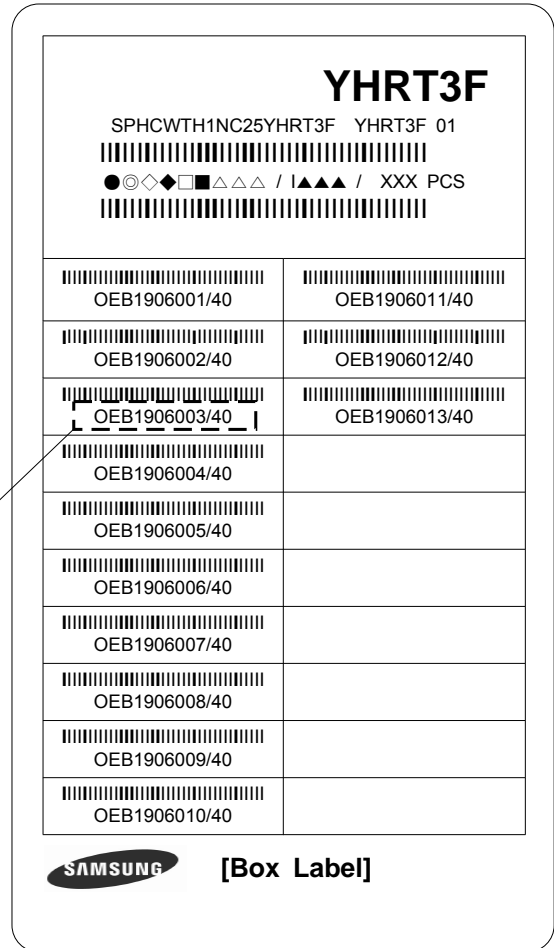

N.B) Denoted rank is the only example.

Rank Code

- ⒶⒷ : Forward Voltage (V_f) Rank (refer to page. 4)
- ⒸⒹ : Chromaticity Coordinate Rank (refer to page. 5)
- ⒺⒻ : Luminous Flux (Φ_v) Rank (refer to page. 4)



9. Lot Number

The Lot number is composed of the following characters

●◎◇◆□■△△△ / |▲▲▲ / xxx PCS

● : Production Site (S:SAMSUNG ELECTRONICS, G:Gosin China, A:Aprosystems)

◎ : L (LED)

◇ : Product State (A:Normality, B: Bulk, C:First Production, R:reproduction, S:Sample)

◆ : Year (U:2010, V:2011, W:2012, X:2013, Y:2014...)

□ : Month (1 ~ 9, A~C)

■ : Day (1 ~ 9, A, B ~ V)

△ : SAMSUNG LED Product number (1 ~ 999)

▲ : Tray Number (1 ~ 999)

10. Tray Dimension

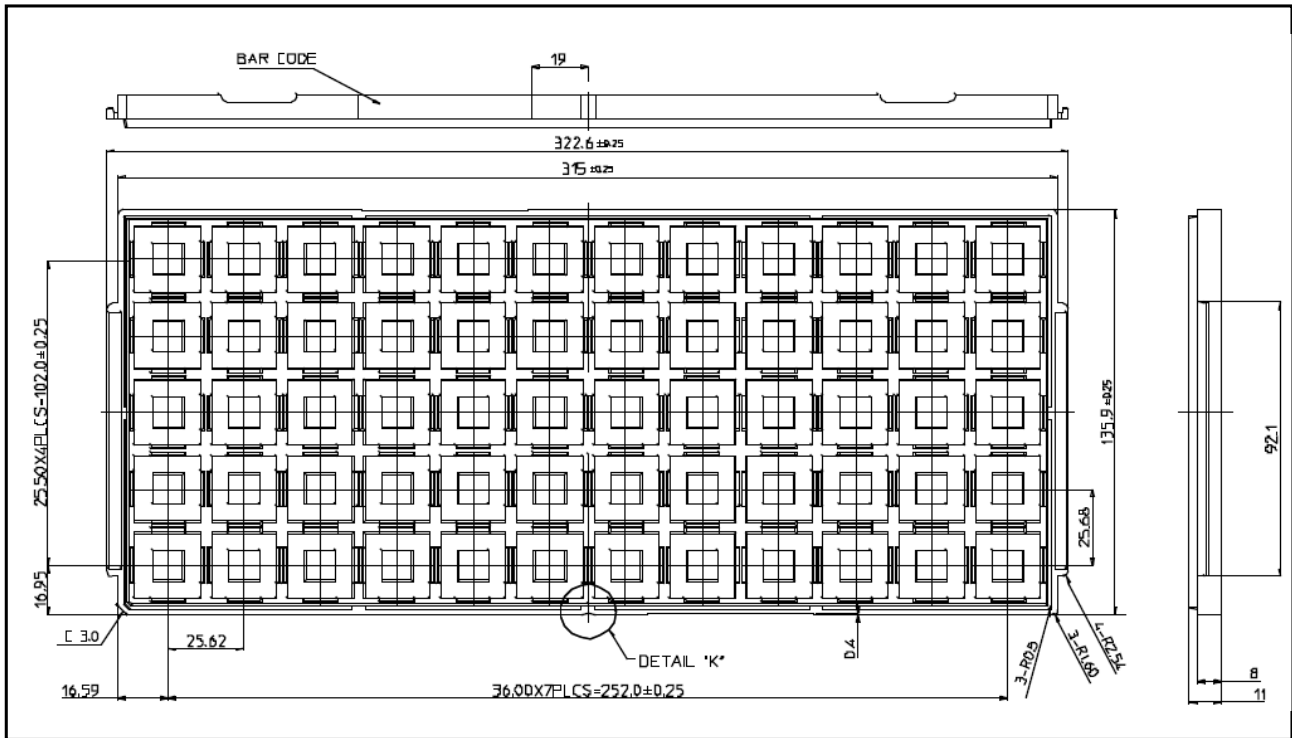

11. Aluminum Bag Dimension

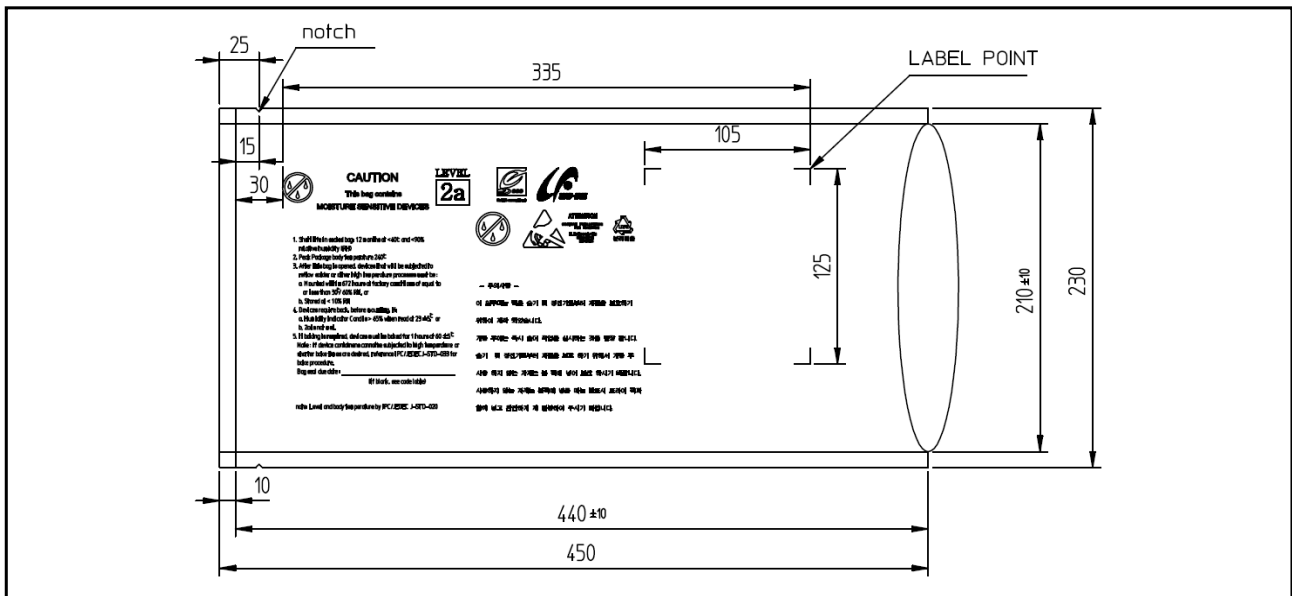

Silica gel & Humidity Indicator Card in Aluminum Bag



12. Box & Pad Dimension

1) Out BOX

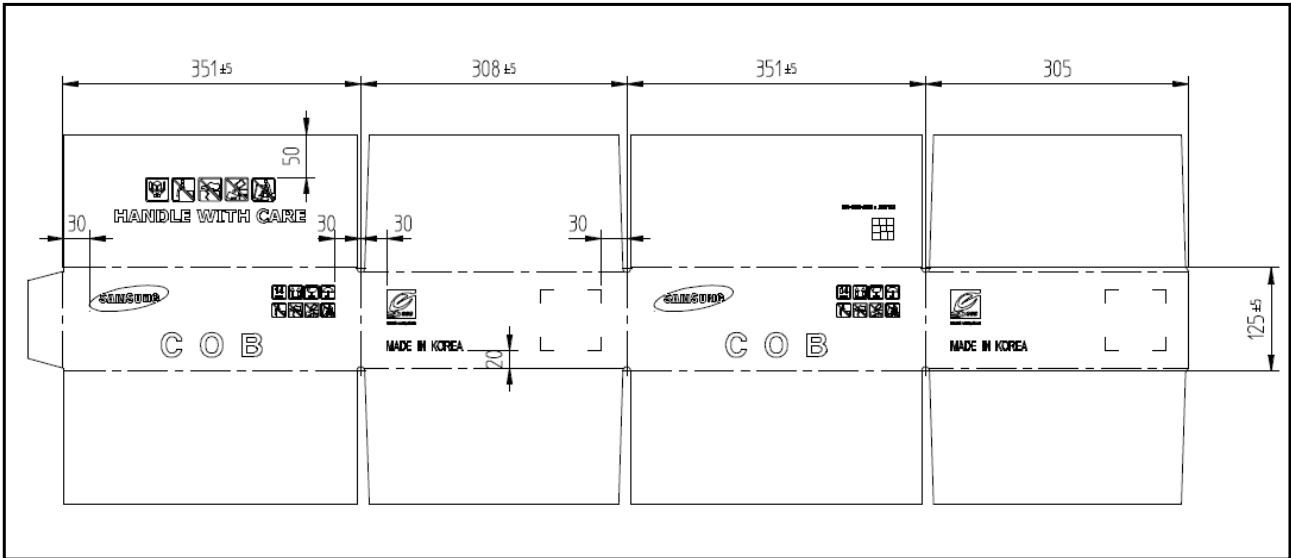

2) Inner BOX

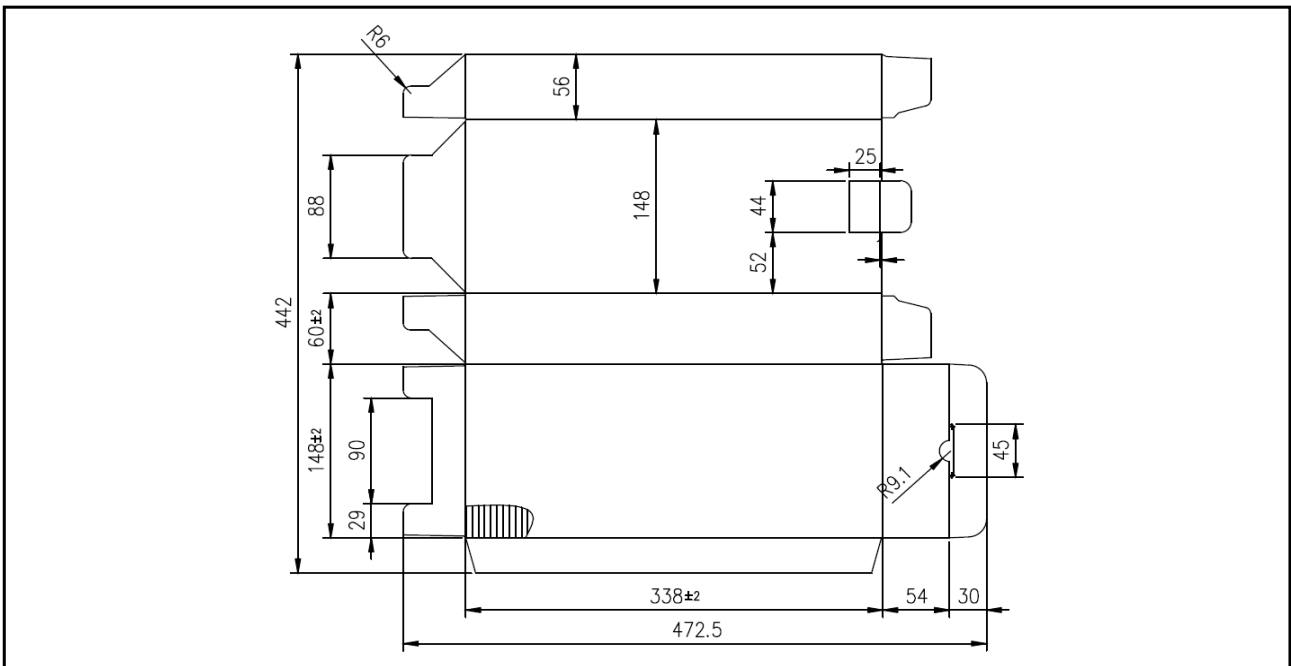

3) Pe-foam PAD

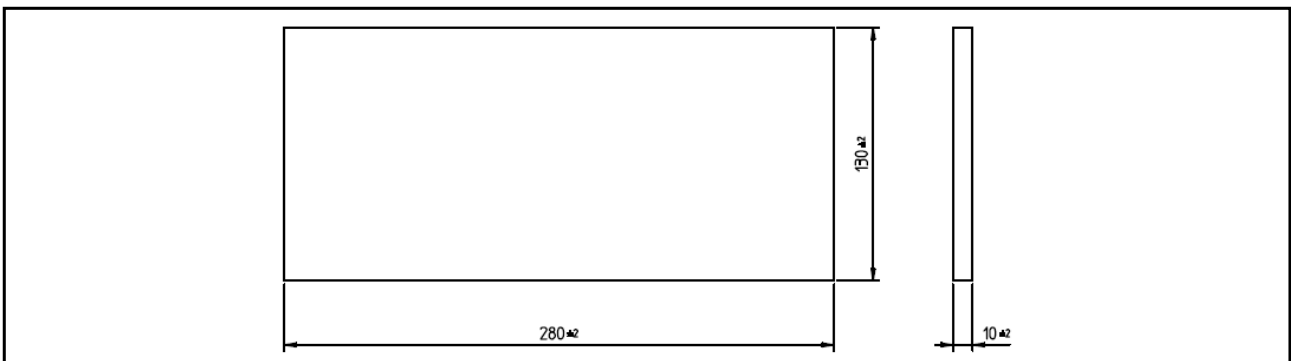

13. Packing Structure

1-1). Tray Packing (When 5 Trays)

Max Amount(pcs)		
Tray	Al Bag	Box
60	300	1200

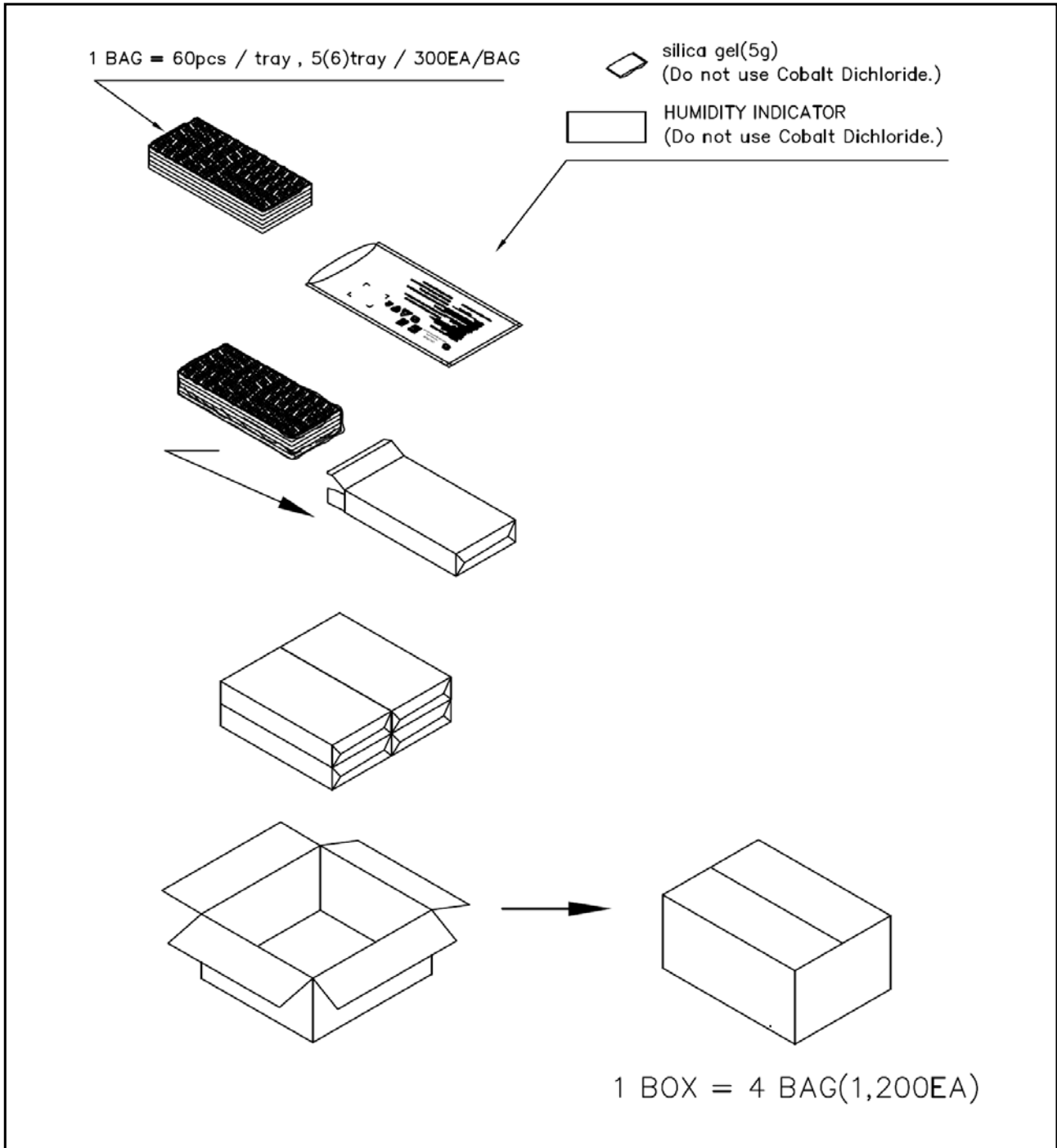

1-2). Tray Packing (When Less than 5 Trays)

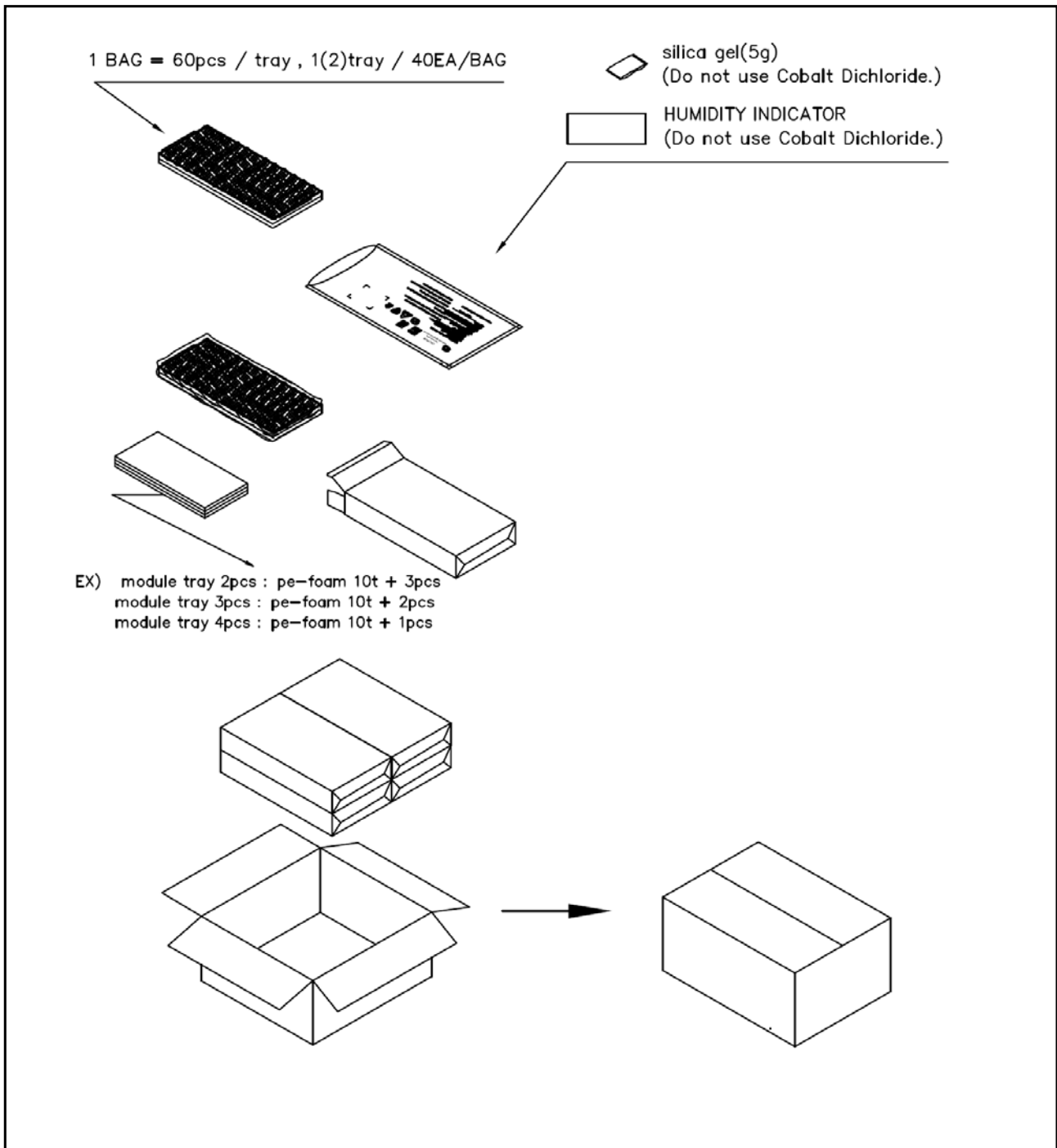

- EX)** Module tray 2pcs : Pe-foam(10t) * 3pcs
 Module tray 3pcs : Pe-foam(10t) * 2pcs
 Module tray 4pcs : Pe-foam(10t) * 1pcs

14. Precaution for use

- 1) Shelf life in sealed bag : 12 months at $< 40^{\circ}\text{C}$ and $< 90\%$ relative humidity(RH)
- 2) Peak package body temperature : 240°C .
- 3) After this bag is opened, devices that will be subjected to reflow solder or other high temperature processes must be :
 - a. Mounted within 672 hours at factory conditions of equal to or less than 30°C / 60% RH, or
 - b. Stored at $< 10\%$ RH
- 4) Devices require bake, before mounting, if :
 - a. Humidity Indicator Card is $> 65\%$ when read at $23 \pm 5^{\circ}\text{C}$, or
 - b. 2a is not met.
- 5) If baking is required, devices must be baked for 1 hours at $60 \pm 5^{\circ}\text{C}$
Note : If device containers cannot be subjected to high temperature or shorter bake times are desired, reference IPC / JEDEC J-STD-033 for bake procedure.
- 6) The LEDs are sensitive to the static electricity and surge current.
It is recommended to use a wrist band or anti-electrostatic glove when handling the LEDs. If voltage exceeding the absolute maximum rating is applied to LEDs, it may cause damage or even destruction to LED devices.

Damaged LEDs may show some unusual characteristics such as increase in leakage current, lowered turn-on voltage, or abnormal lighting of LEDs at low current.

7) Please do not following behavior in resin area.

(Handling, Pressing, Touching, Rubbing, Contacting tweezers, Cleaning)

But it's ok in handling area.

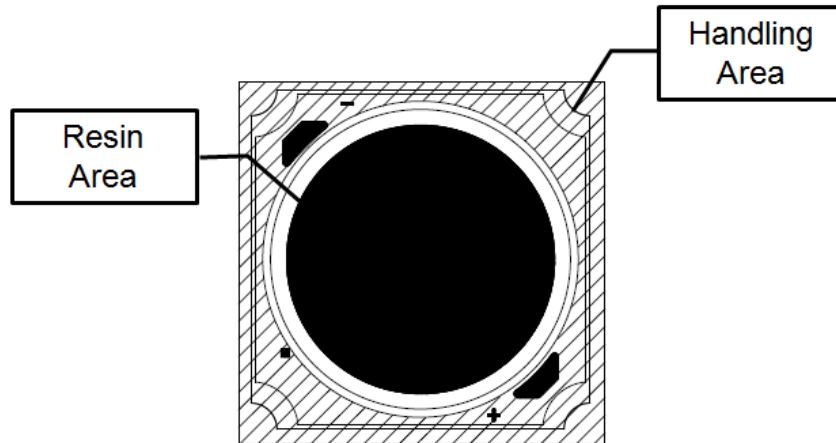

8) VOCs (volatile organic compounds) may be occurred by adhesives, flux, hardener or organic additives which is used in luminaires (fixture) and LED silicone bags are permeable to it. It may lead a discoloration when LED expose to heat or light.

This phenomenon can give a significant loss of light emitted(output) from the luminaires (fixtures).

In order to prevent these problems, we recommend you to know the physical properties for the materials used in luminaires, It requires to select carefully.