



PC104R.A.07.0165C

## Specification

<b>Part No.</b>	<b>PC104R.A.07.0165C</b>
<b>Product Name</b>	Penta-Band PCB Antenna with Diagnostic Resistor
<b>Feature</b>	GSM/CDMA/DCS/PCS/WCDMA/UMTS/HSDPA/GPRS/EDGE 850/900/1800/1900/2100 MHz bands High Efficiency - even at long cable lengths 164.9mm $\Phi$ 1.37 coaxial cable with IPEX connector 80mm*20.8mm*1mm Low profile AntD© Shunt 10k Ohm Chip Resistor Inside With 3M adhesive RoHS compliant



## 1. Introduction

The high efficiency embedded PC104R Penta-band PCB Antenna with AntD© Resistor slim-line design allows for convenient installation inside the customer device. Omni-directional gain across all bands ensures constant reception and transmission.

With its unique dipole design, the PC104R has exceptional industry performance characteristics considering its very low profile at 2.4mm and has a compact size 80mm\*20mm. It is suitable for clients that appreciate highest performance with lower price.

This antenna has 3M adhesive on the back, and is tuned and designed to be mounted on 2mm thickness plastic (not on metal). Cable lengths and connectors are fully customizable and the antenna is suitable for long cable lengths out to 2 metres. For good efficiency performance the shortest cable length should however not be less than 100mm, for requirements with shorter cable lengths the alternative product the FXP.14 can be used.

AntD© allows connected radio products designed using the latest cellular modules from companies such as Telit and uBlox

to perform diagnostics on the antenna. This includes detection that the proper antenna is connected and that the connection isn't shorted or broken.

Contact Taoglas engineering for examples on how to implement AntD© antenna diagnostics in your product.

## 2. Specification

### Electrical

	<b>GSM 850</b>	<b>GSM 900</b>	<b>DCS</b>	<b>PCS</b>	<b>2100</b>
<b>Frequency (MHz)</b>	824~896	880~960	1710~1880	1850~1990	1920~2170
<b>Return Loss (dB)*</b>	< -7	< -5	< -10	< -10	< -10
<b>Efficiency (%)*</b>	42	42	70	75	78
<b>Peak Gain (dBi)*</b>	0.77	0.99	2.26	2.13	2.39
<b>Impedance</b>	50Ω				
	<b>Integrated AntD© Resistor</b>				
<b>Resistor</b>	Shunt 10K Ohm (+/- 5%) to Ground				
<b>Polarization</b>	Linear				
<b>Power Handled</b>	50 W				

### Mechanical

<b>Antenna Dimensions</b>	80*20*1mm
<b>Connector</b>	IPEX
<b>Material</b>	FR4
<b>Cable Type</b>	Φ1.37 Coaxial cable
<b>Cable Length</b>	164.9mm
<b>Adhesive</b>	3M 467

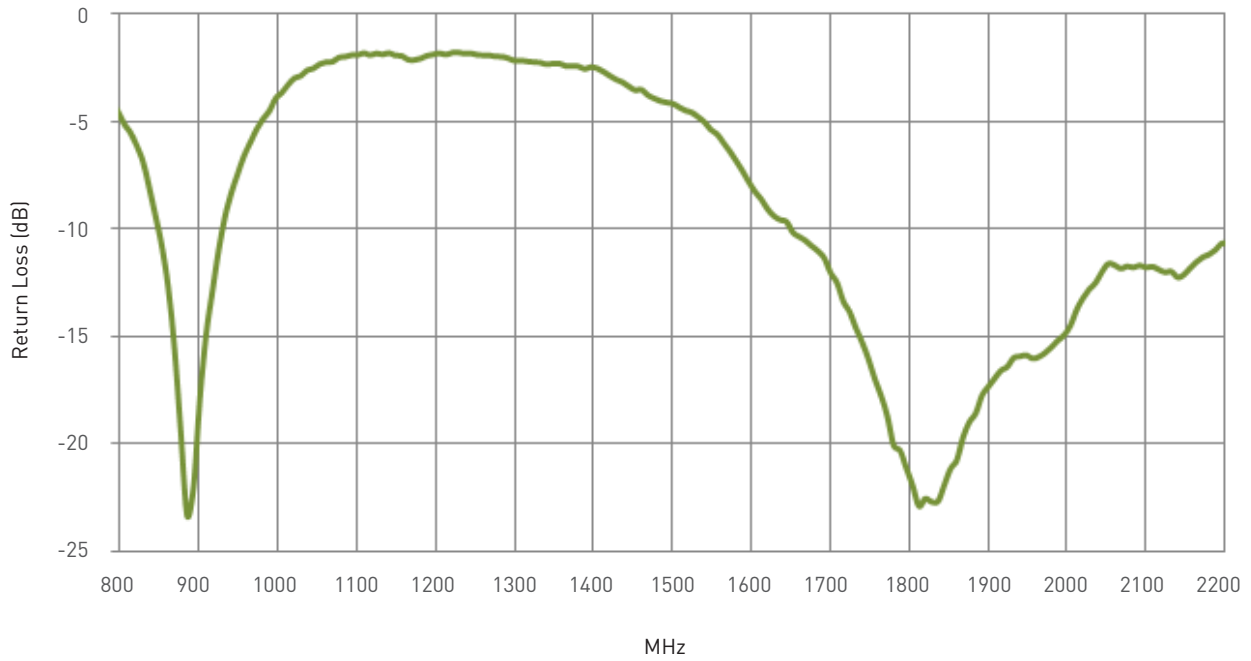
### Environmental

<b>Operation Temp.</b>	-40°C ~ +85°C
<b>Storage Temp.</b>	-40°C ~ +85°C

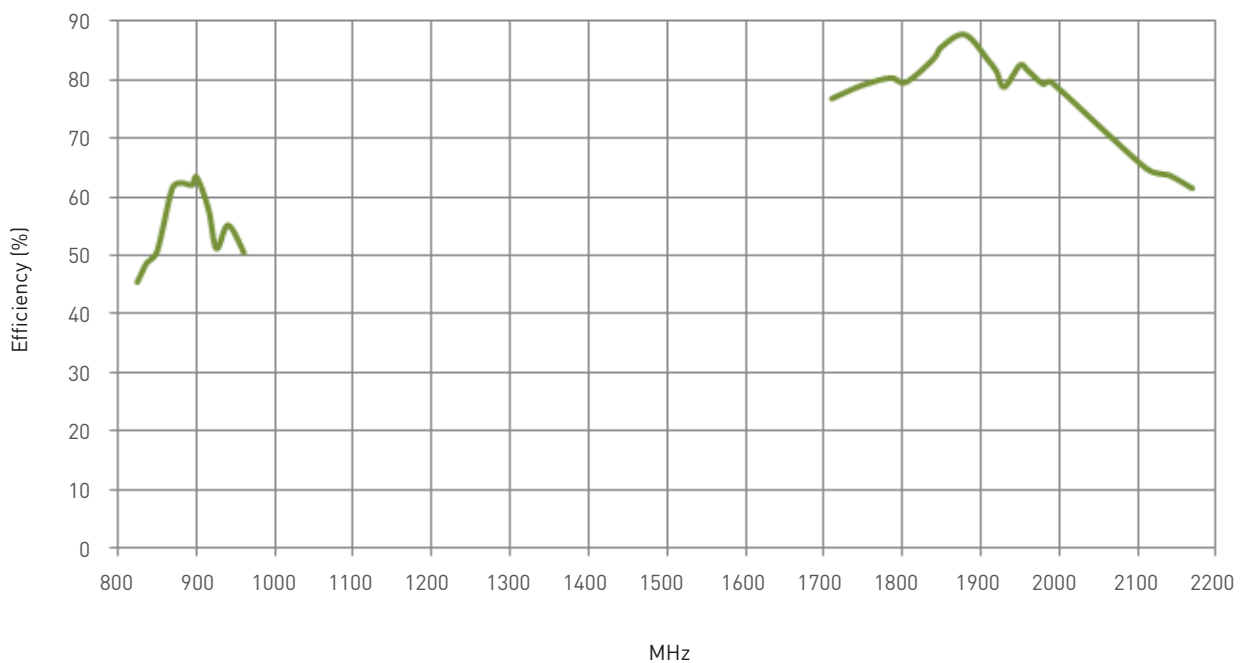
\* Antenna is tested on a 2mm thickness ABS material base substrate

### 3. Antenna Parameters

#### 3.1 Return Loss

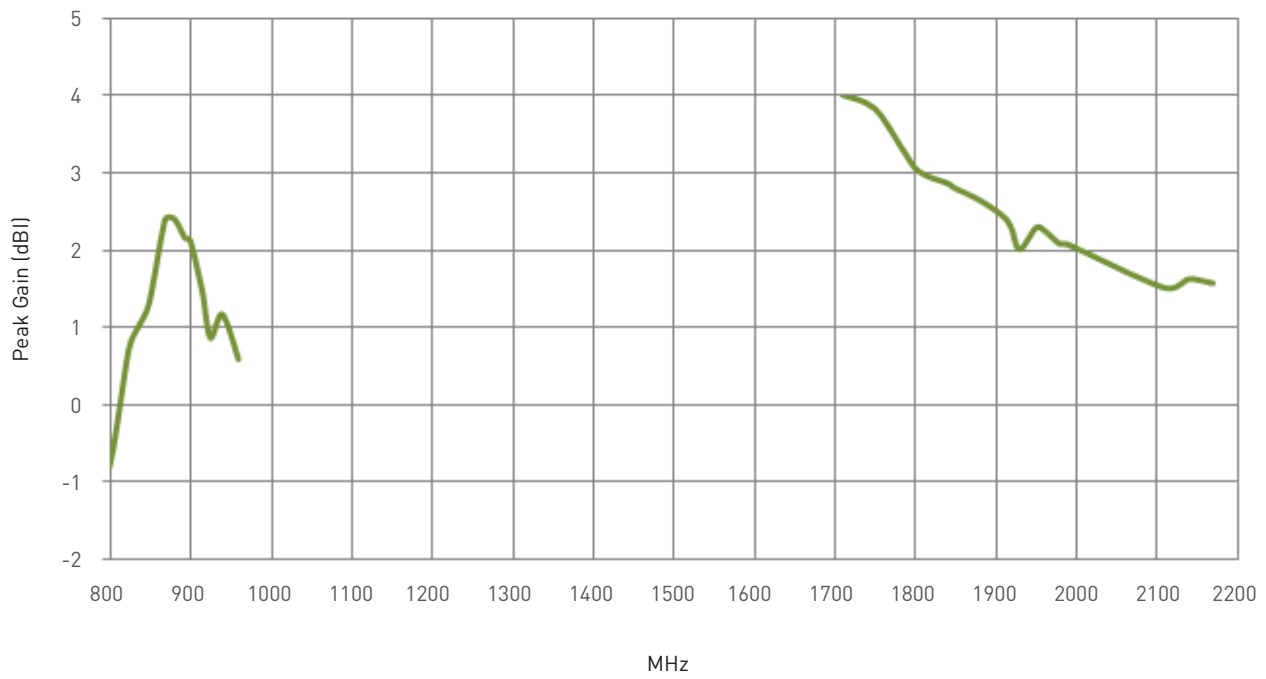


#### 3.2 Antenna Efficiency

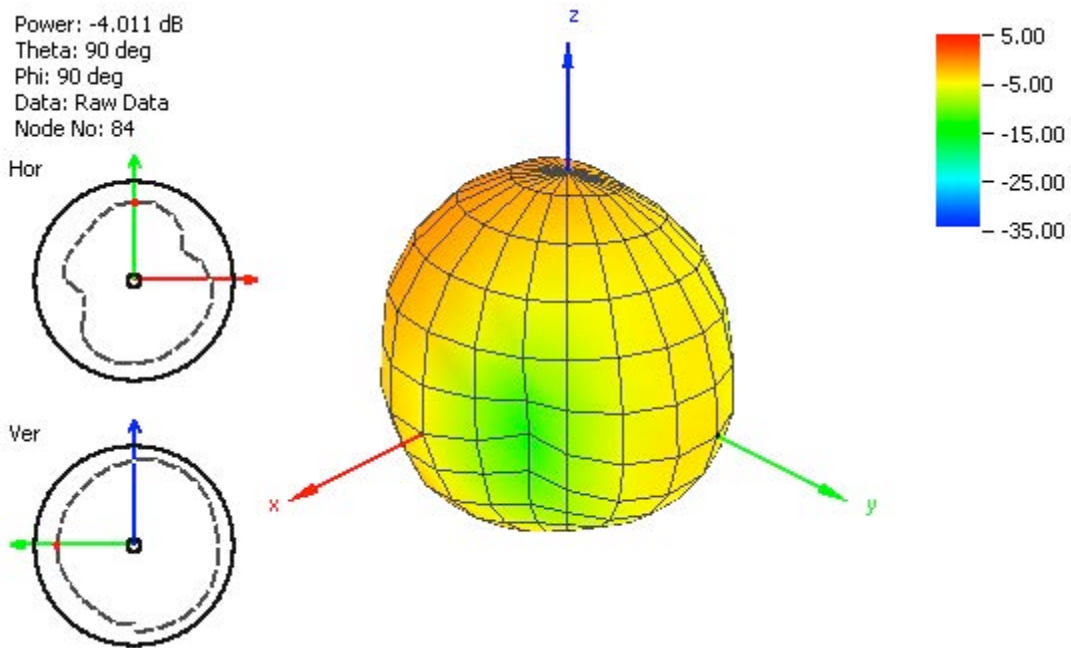


### 3. Antenna Characteristics

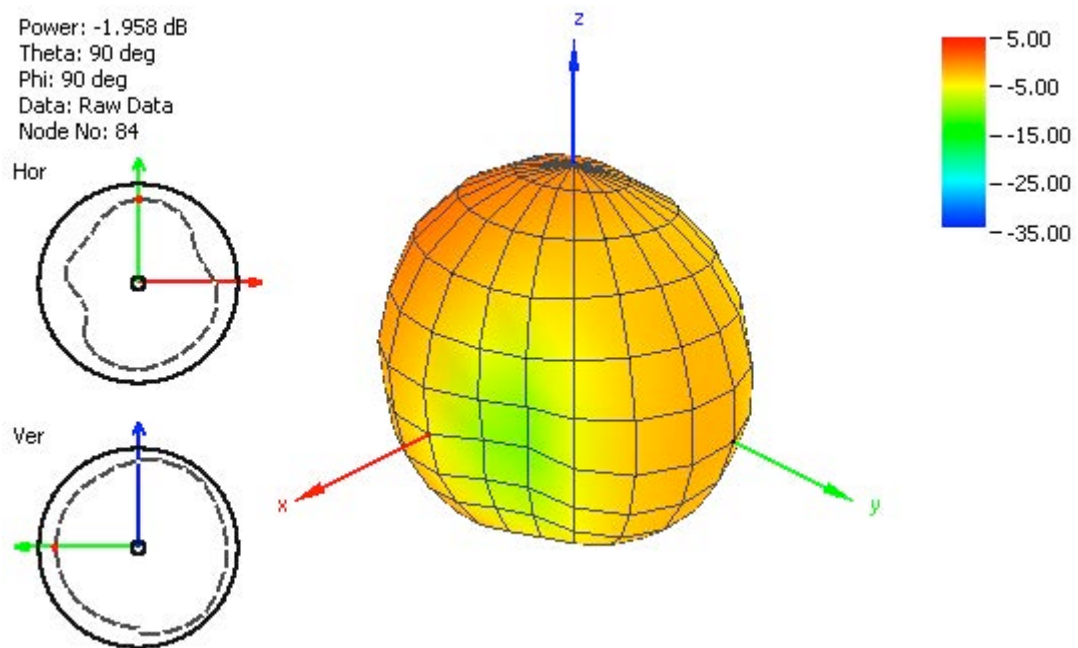
#### 3.3 Peak Gain



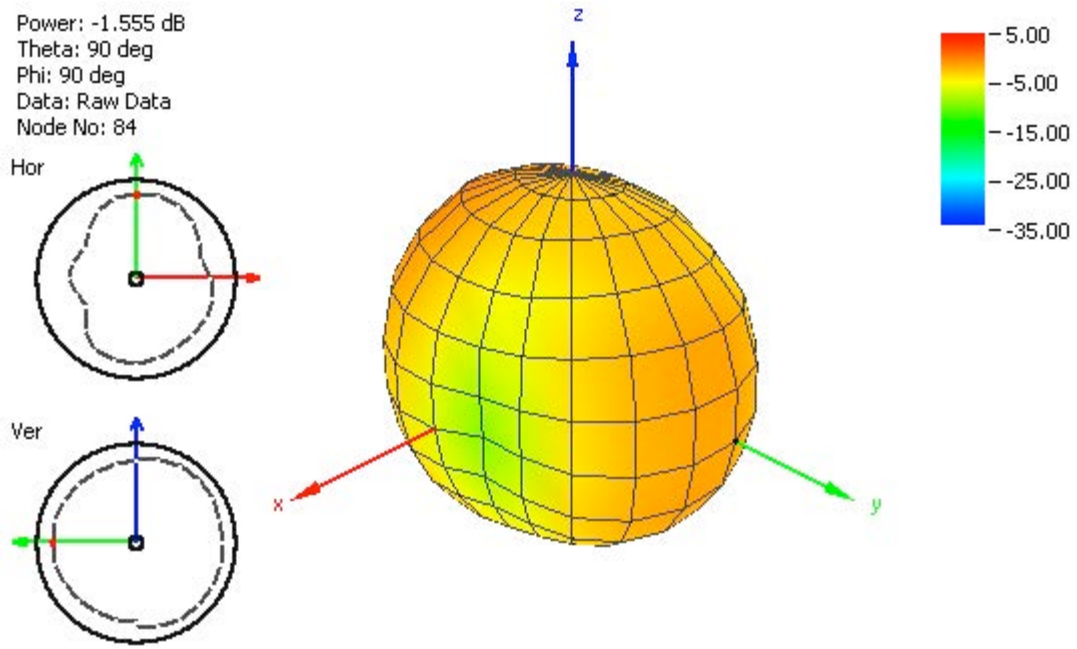
## 4. Radiation Patterns



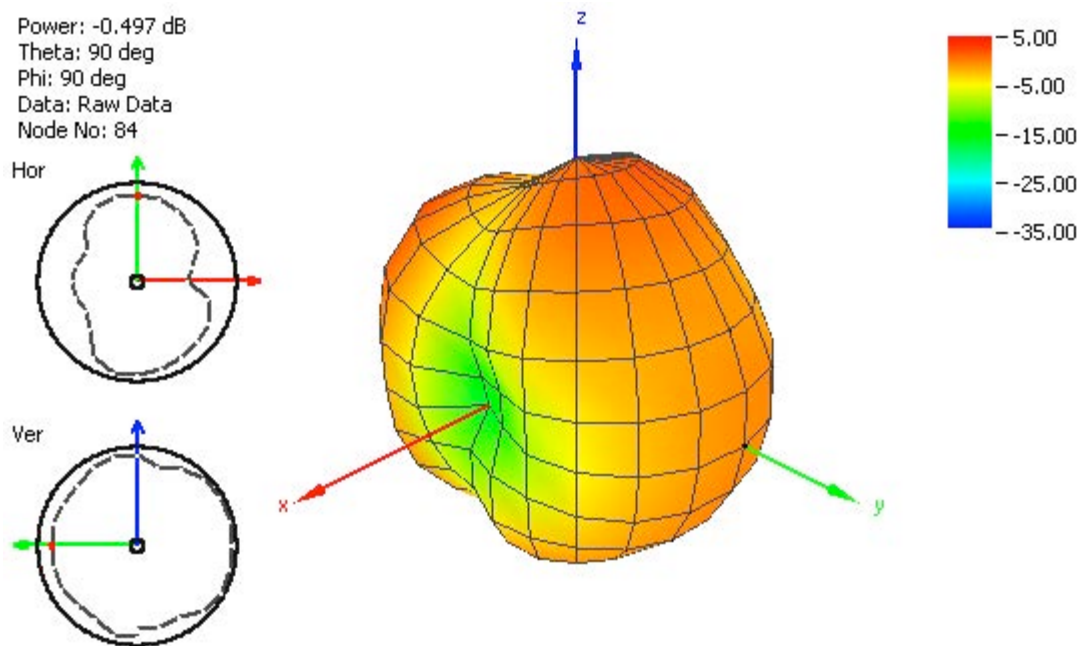
**Figure 1.** Radiation Pattern at 824 MHz.



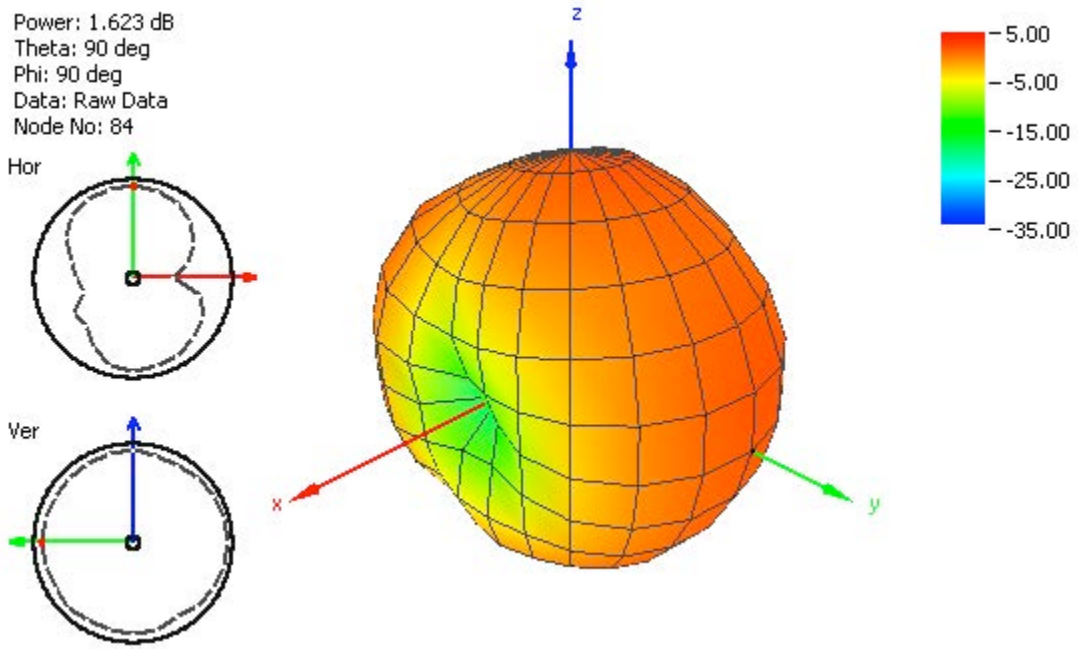
**Figure 2.** Radiation Pattern at 880 MHz.



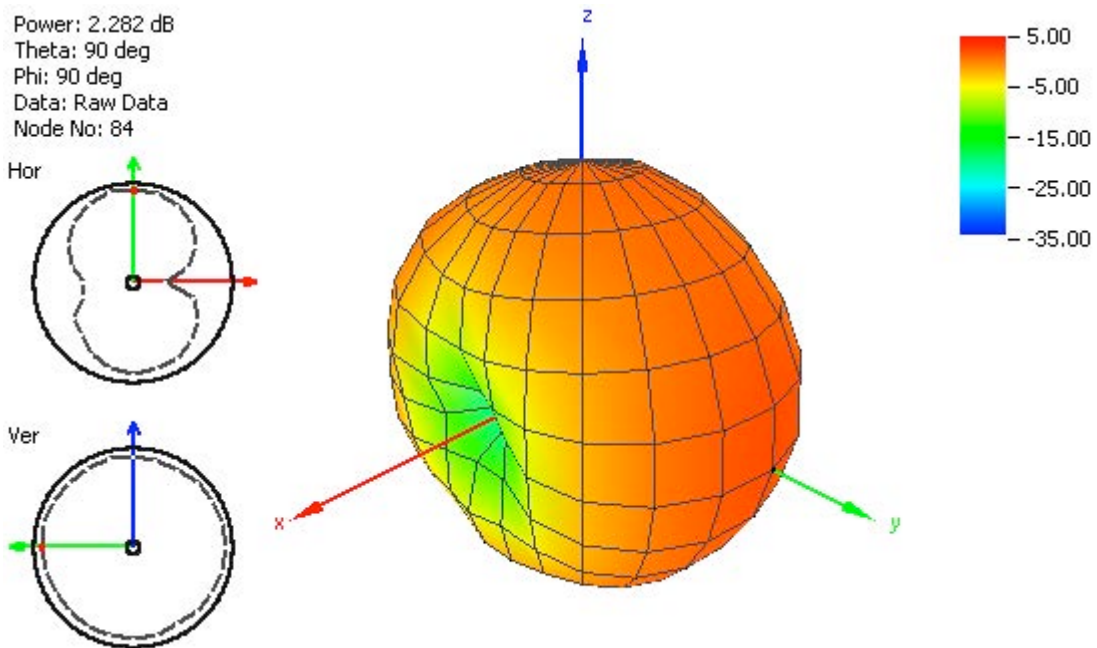
**Figure 3.** Radiation Pattern at 960 MHz.



**Figure 4.** Radiation Pattern at 1710 MHz.

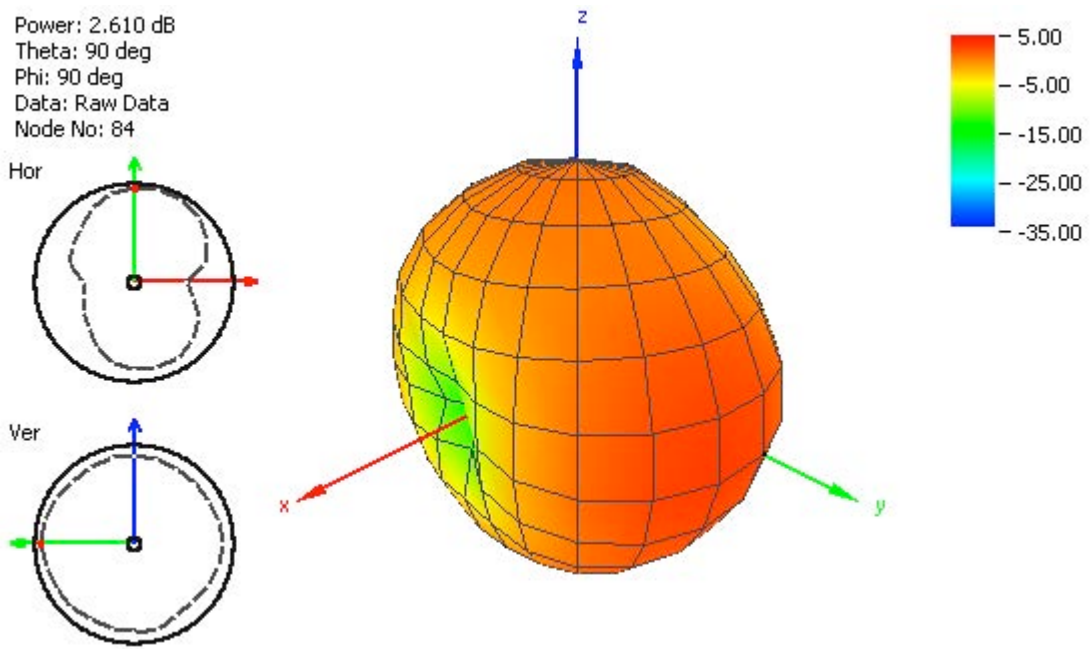


**Figure 5.** Radiation Pattern at 1880 MHz.



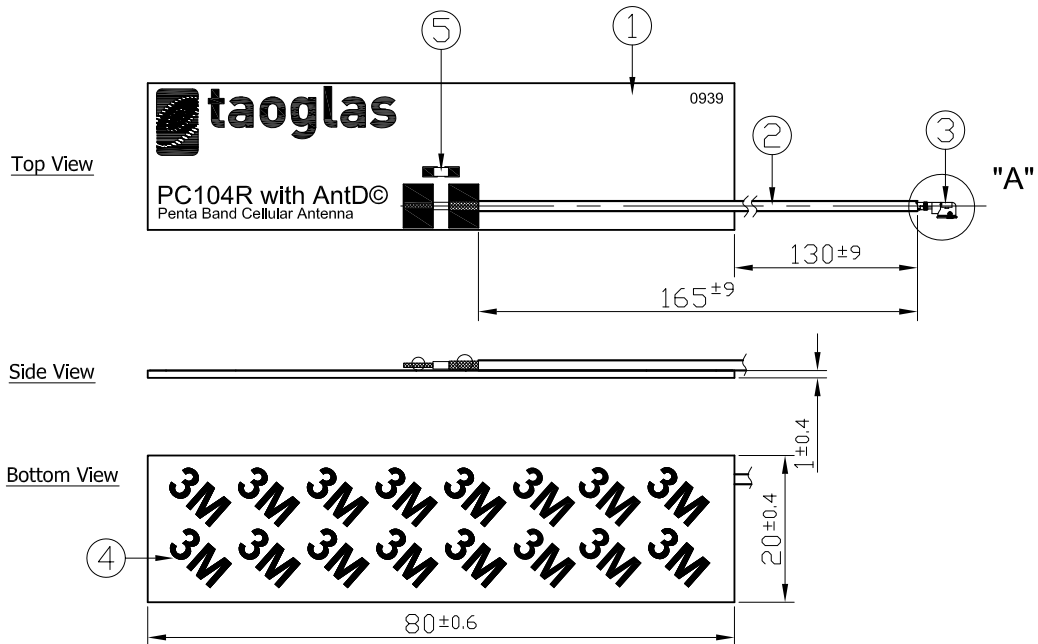
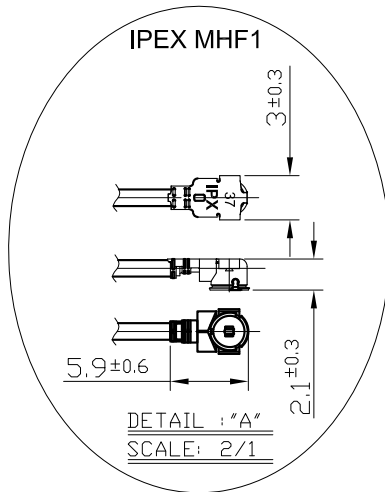
**Figure 6.** Radiation Pattern at 1990 MHz.





**Figure 7.** Radiation Pattern at 2110 MHz.

## 5. Drawing

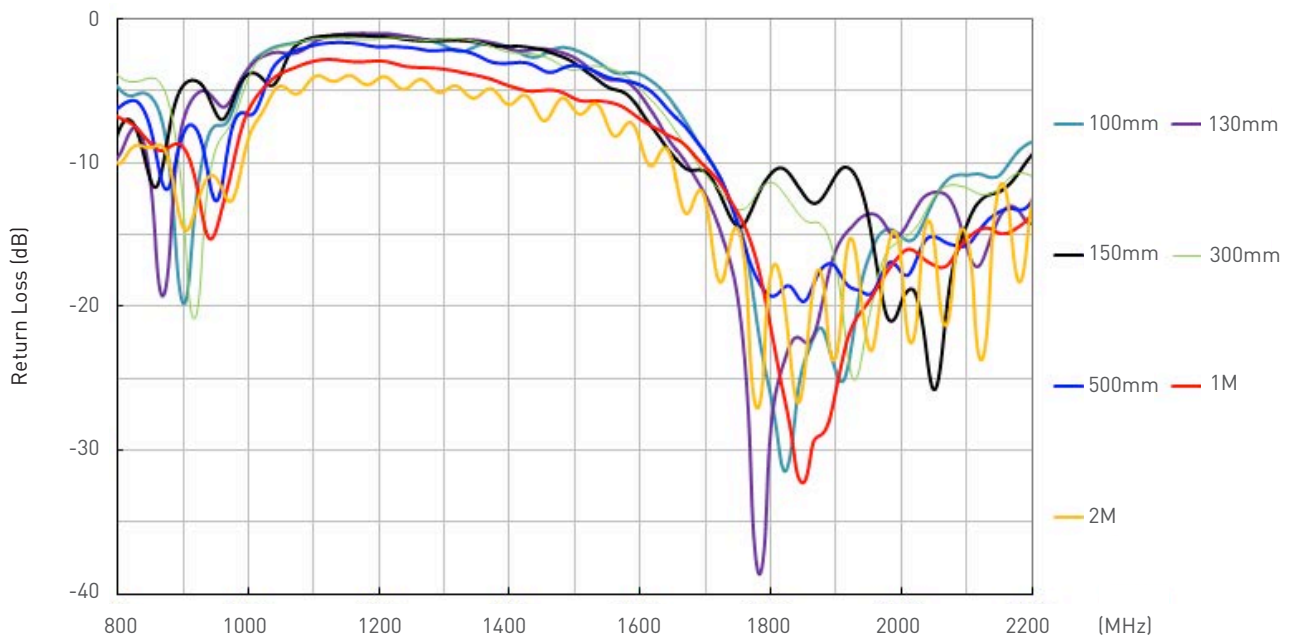


	Name	P/N	Material	Finish	QTY
1	PC104R PCB	100213G000011A	FR4 1t	Black	1
2	1.37 Coaxial Cable	300513A000002A	FEP	Black	1
3	IPEX MHFI	204511G000002A	Brass	Gold	1
4	3M Adhesive	001012K000039A	3M 9448	N/A	1
5	Resistor (R=10k Ohm)	001513G000055A	Ceramic	N/A	1

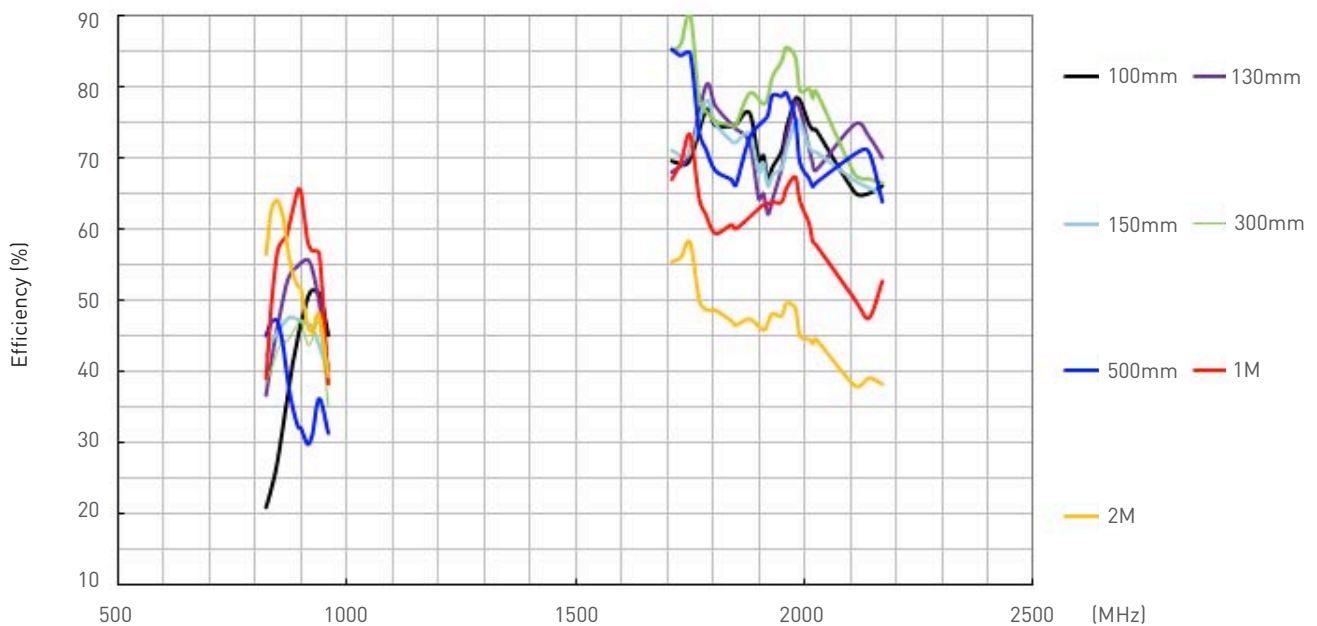
## 6. Application Note

We measured PC.104 antenna with different cable length, the results as below,

### Return Loss

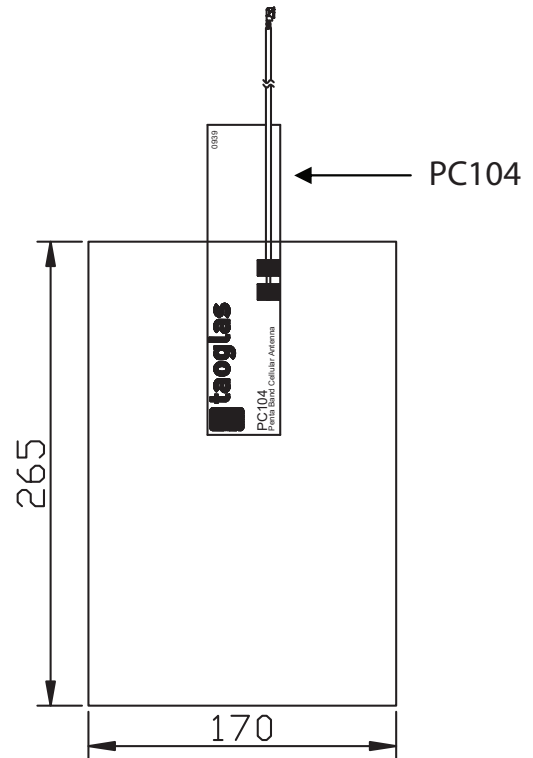
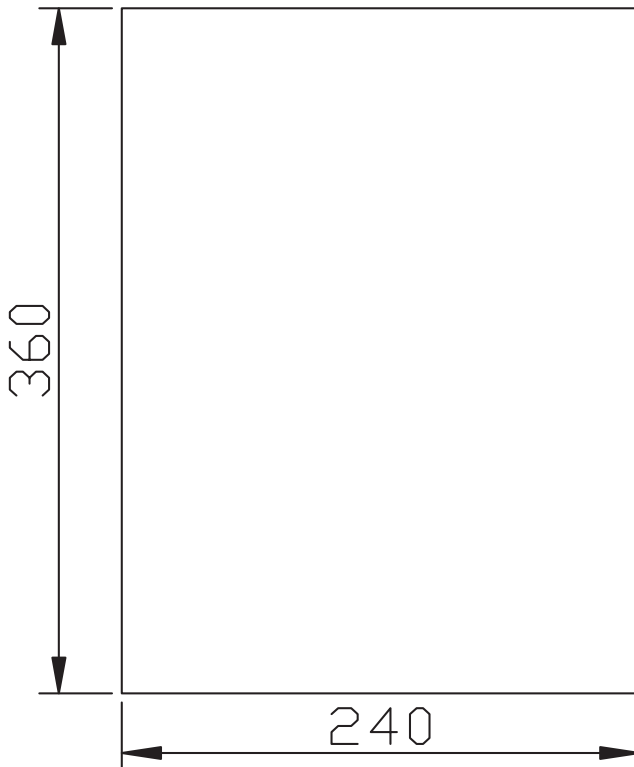


### Efficiency



100pcs antenna per small PE bag  
 5 small PE bags per big PE bag  
 500pcs antennas per big PE bag

Unit : mm



Taoglas makes no warranties based on the accuracy or completeness of the contents of this document and reserves the right to make changes to specifications and

product descriptions at any time without notice. Taoglas reserves all rights to this document and the information contained herein.

Reproduction, use or disclosure to third parties without express permission is strictly prohibited.  
 Copyright © Taoglas Ltd.