

# ISL85415EVAL2Z Wide $V_{IN}$ , Negative $V_{OUT}$ , Synchronous Buck-Boost Regulator up to 500mA

## Description

The ISL85415EVAL2Z kit is intended for point-of-load applications sourcing from 3V to 31V. The kit is used to demonstrate the performance of the ISL85415 wide  $V_{IN}$ , low quiescent current, high efficiency, synchronous buck-boost regulator, in a negative output configuration with up to 500mA output current.

The ISL85415 is offered in a 4mm x 3mm 12 Ld DFN package with 1mm maximum height. The converter occupies 2.418cm<sup>2</sup> area.

## Specifications

This board has been configured and optimized for the following operating conditions:

- $V_{IN}$  = 3V to 31V
- $V_{OUT}$  = -5V
- $I_{MAX}$  = 500mA (at  $V_{IN}$  = 31V)
- Peak efficiency: >85.6% at 250mA,  $V_{IN}$  = 12V
- Board temperature: +25°C

## Related Literature

- For a full list of related documents, visit our website - [ISL85415](#) product page

## Key Features

- Wide input voltage range, 3V to 31V
- Synchronous operation for high efficiency
- Integrated high-side and low-side NMOS devices
- Programmable switching frequency (fixed or externally synchronized)
- Continuous output current up to 500mA (See [Figure 7](#))
- Internal or external soft-start
- Minimal external components required
- Power-good and enable functions available
- On-board jumper for selecting PFM or forced PWM at light loads
- On-board EN switch

## Recommended Equipment

The following materials are recommended to perform testing:

- 0V to 50V power supply with at least 2A source current capability
- Electronic loads capable of sinking current up to 1.5A
- Digital Multimeters (DMMs)
- 100MHz quad-trace oscilloscope

## Ordering Information

PART NUMBER	DESCRIPTION
ISL85415EVAL2Z	Wide $V_{IN}$ (3V-31V) Negative $V_{OUT}$ Sync Buck-Boost Integrated FET Regulator up to 500mA

# Application Note 1934

TABLE 1. EXTERNAL COMPONENT SELECTION

V <sub>OUT</sub> (V)	L <sub>1</sub> (μH)	C <sub>5</sub> ,C <sub>6</sub> (μF)	R <sub>1</sub> (kΩ)	R <sub>2</sub> (kΩ)	C <sub>4</sub> (pF)	R <sub>FS</sub> (kΩ)	R <sub>3</sub> (kΩ)	C <sub>7</sub> (pF)	C <sub>8</sub> (pF)
-12	47	2x22	90.9	4.75	180	115	49.9	2200	220
-5	22	2x22	90.9	12.4	220	120	20	2200	220
-3.3	22	2x22	90.9	20	220	120	20	2200	220

## PCB Layout Guidelines

The ISL85415EVAL2Z PCB layout has been optimized for electrical and thermal performance. Proper layout of the power converter will minimize EMI and noise while ensuring first pass success of the design.

PCB layouts are provided in multiple formats on the Intersil website. In addition, [Figures 3 to 6](#) will clarify the important points in PCB layout. PCB layout of the ISL85415EVAL2Z is quite simple.

A multi-layer printed circuit board with GND plane is recommended. [Figure 3](#) shows the connections of the critical components in the converter. The most critical connections are to tie the PGND pin to the package GND pad and then use vias to directly connect the GND pad to the system GND plane. This connection of the GND pad to system plane insures a low impedance path for all return current, as well as an excellent thermal path to dissipate heat.

With this connection made, place the high frequency MLCC input capacitors C<sub>1</sub>, C<sub>2</sub> near the VIN pin and use vias directly at the capacitor pads to tie the capacitors to the system GND plane. Also use vias directly at the C<sub>5</sub>, C<sub>6</sub> output capacitor pads to tie the capacitors to the system GND plane. These measures will minimize the high dV/dt and dI/dt loops.

Minimize the PHASE connection by placing L<sub>1</sub> close to the IC and on the same side. Place the BOOT capacitor (C<sub>3</sub>) very close to the IC.

Place a 1μF MLCC near the VCC pin and directly connect its return with a via to the system GND plane.

Keep the power components path (L<sub>1</sub>, C<sub>1</sub>, C<sub>2</sub>, C<sub>3</sub>, C<sub>5</sub>, C<sub>6</sub>) separated from the small signal nodes (FB, COMP) and the control components path (FS, SS) by placing the feedback divider close to the FB pin and do not route any feedback components near PHASE or BOOT. If external components are used for SS, COMP, or FS, the same advice applies. Connect these control components and small signal noise components to system GND.

Keep the small signal nodes traces (FB, COMP) as short as possible.

## Quick Setup Guide

1. Ensure that the circuit is correctly connected to the supply and loads prior to applying any power.
2. Connect the bias supply to VIN, the plus terminal to VIN (P4), and the negative return to GND (P5).
3. Verify that the position is ON for SW1.
4. Turn on the power supply.
5. Verify the output voltage is -5V for -V<sub>NEG</sub> (P7).

## Evaluating the Other Output Voltages

The ISL85415VAL1Z kit output is preset to -5V, however the output can be adjusted from -3.3V to -12V. The output voltage programming resistor, R<sub>2</sub>, will depend on the desired output voltage of the regulator and the value of the feedback resistor R<sub>1</sub>, as shown in [Equation 1](#).

$$R_2 = R_1 \left( \frac{0.6}{V_{OUT} - 0.6} \right) \quad (\text{EQ. 1})$$

[Table 1](#) shows the component selection that should be used for the respective V<sub>OUTS</sub> of -3.3V, -5V and -12V.

The curves in [Figure 7](#) indicate the maximum output current the converter can deliver as a function of the input voltage and the selected output voltage configuration.

[Figures 8, 9, and 10](#) show the efficiency for different input voltage, output voltage and load combinations. [Figures 11, 12, and 13](#) show the output regulation with load while [Figures 14, 15, and 16](#) show the output regulation with input voltage for different output voltages. [Figures 17 to 21](#) show some performance curves of the board during start-up, shutdown, steady state, and load transient.

## Frequency Control

The ISL85415 has an FS pin that controls the frequency of operation. Programmable frequency allows for optimization between efficiency and external component size. It also allows low frequency operation for low V<sub>OUTS</sub> when minimum on time would limit the operation otherwise. Default switching frequency is 500kHz when FS is tied to V<sub>CC</sub> (R<sub>10</sub> = 0). By removing R<sub>10</sub>, the switching frequency could be changed from 300kHz (R<sub>12</sub> = 340k) to 2MHz (R<sub>12</sub> = 32.4k). Refer to the [ISL85415](#) datasheet for calculating the value of R<sub>10</sub>. Do not leave this pin floating.

## Disabling/Enabling Function

The ISL85415EVAL2Z evaluation board contains a SW1 switch that enables or disables the part, thus allowing low quiescent current state. [Table 2](#) details this function.

TABLE 2. SWITCH SETTINGS

SW1	ON/OFF CONTROL
ON	Enable V <sub>OUT</sub>
OFF	Disable V <sub>OUT</sub>

# Application Note 1934

## SYNC Control

The ISL85415EVAL2Z evaluation board has a SYNC pin that allows external synchronization frequency to be applied. Default board configuration has  $R_6 = 200k$  to  $V_{CC}$ , which defaults to PWM operation mode and also to the pre-selected switching frequency set by  $R_{12}$  (see datasheet and previous section "[Frequency Control](#)" on page 2 for details). If this pin is tied to

GND the IC will operate in PFM mode. JP1 switch allows to force the PFM or PWM modes.

## Soft-Start /COMP Control

$R_{15}$  selects between internal ( $R_{15} = 0$ ) and external soft-start.  $R_{11}$  selects between internal ( $R_{11} = 0$ ) and external compensation. Refer to the Pin Description Table (Page 3) of the [ISL85415](#) datasheet.

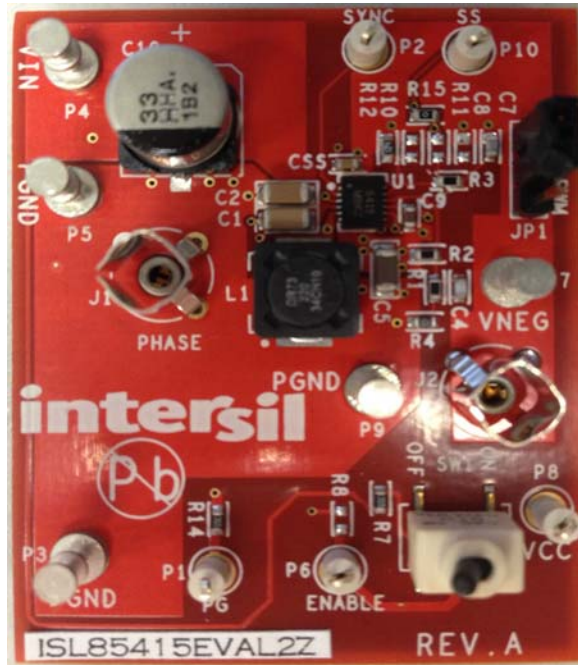
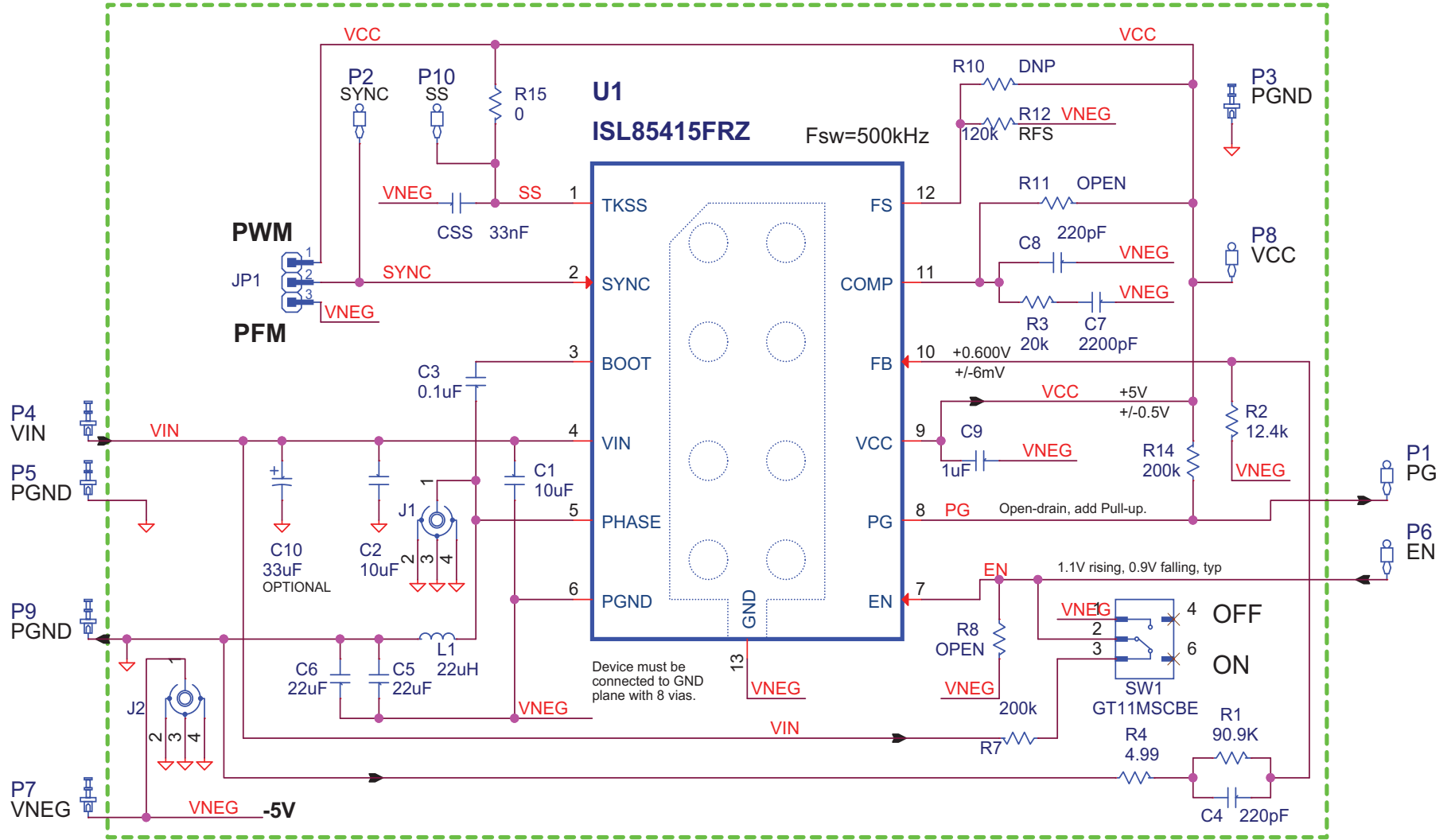

FIGURE 1. FRONT OF EVALUATION BOARD ISL85415EVAL2Z



FIGURE 2. BACK OF EVALUATION BOARD ISL85415EVAL2Z

# ISL85415EVAL2Z Schematic



NOTE: The input electrolytic capacitor C<sub>10</sub> is optional and it is used to prevent transient voltages when the input test leads have large parasitic inductance. It can be removed if the IC is used in a system application.

## Application Note 1934

### ISL85415EVAL2Z Bill of Materials

PART NUMBER	QTY	REF-DES	DESCRIPTION	MANUFACTURER
ISL8541XEVAL2ZREVAPCB	1	N/A	PCB - ISL85415 NEGATIVE VOUT EVALUATION BOARD	Imagineering Inc
EEE-HA1H330UP	1	C10	CAP, SMD, 8mm, 33uF, 50V, 20%, ALUM. ELEC, ROHS	Panasonic
GRM188R71H221JA01D	1	C4, C8	CAP, SMD, 0603, 220pF, 50V, 5%, X7R, ROHS	Murata
06035C104KAT2A	1	C3	CAP, SMD, 0603, 0.1uF, 50V, 10%, X7R, ROHS	AVX
GRM188R61C105KA12D	1	C9	CAP, SMD, 0603, 1uF, 16V, 10%, X5R, ROHS	Murata
GRM188R71H222JA01D	1	C7	CAP, SMD, 0603, 2200pF, 50V, 5%, X7R, ROHS	Murata
C3216X5R1H106K	2	C1,C2	CAP, SMD, 1206, 10uF, 50V, 10%, X5R, ROHS	TDK
ECJ-DV50J226M	1	C5	CAP, SMD, 1206, 22uF, 6.3V, 20%, X5R, ROHS	Panasonic
C1608X5R0J226M	1	C6	CAP, SMD, 0603, 22uF, 6.3V, 20%, X5R, ROHS	TDK
131-4353-00	2	J1,J2	CONN-SCOPE PROBE TEST PT, COMPACT, PCB MNT, ROHS	Tektronix
68000-236HLF	1	JP1	CONN-HEADER, 1x3, BREAKAWY 1X36, 2.54mm, ROHS	Berg/FCI
1514-2	5	P4,P5,P3, P7,P9	CONN-TURRET, TERMINAL POST, TH, ROHS	Keystone
5002	5	P1,P2,P6, P8,P10	CONN-MINI TEST POINT, VERTICAL, WHITE, ROHS	Keystone
RNCF0603DTE4R99	1	R4	RES, SMD, 0603, 4.99Ω, 1/10W, 0.5%, TF, ROHS	Stackpole
CR0603-10W-000T	1	R15	RES, SMD, 0603, 0Ω, 1/10W, TF, ROHS	Venkel
ERJ-PB3D2002V	1	R3	RES, SMD, 0603, 20K, 1/5W,0.5%, TF, ROHS	Panasonic Electronic Components
CR0603-10W-1242FT(PbFREE)	1	R2	RES, SMD, 0603, 12.4K, 1/10W, 1%, TF, ROHS	Venkel
ERJ-3EKF9092V	1	R1	RES, SMD, 0603, 90.9K, 1/10W, 1%, TF, ROHS	Panasonic
CRCW0603120KFKEA	1	R12	RES, SMD, 0603, 120K, 1/10W, 1%, TF, ROHS	Vishay/Dale
GT11MSCBE	1	SW1	SWITCH-TOGGLE, SMD, 6PIN, SPDT, 2POS, ON-ON, ROHS	ITT Industries/ C&K Division
DR73-220-R	1	L1	COIL-PWR INDUCTOR, SMD, 7.6mm, 22uH, 20%, 1.62A, ROHS	Cooper/Coiltronics
ISL85415FRZ	1	U1	IC-500mA BUCK REGULATOR, 12P, DFN, 3X4, ROHS	Intersil
GRM188R71H221JA01D	1	C8	CAP, SMD, 0603, 220pF, 50V, 5%, X7R, ROHS	Murata
	0	R8,R10,R 11	RES, SMD, 0603, DNP-PLACE HOLDER, ROHS	
C0603X7R160-333KNE	1	CSS	CAP, SMD, 0603, 33000pF, 16V, 10%, X7R, ROHS	Venkel
LABEL-RENAME BOARD	1		ISL85415EVAL2Z.	Intersil
CR0603-10W-2003FT	2	R14,R7	RES, SMD, 0603, 200K, 1/10W, 1%, TF, ROHS	Venkel
SPC02SYAN	1	JP1-PWM	CONN-JUMPER, SHORTING, 2PIN, BLACK, GOLD, ROHS	Sullins

# ISL85415EVAL2Z Board Layout

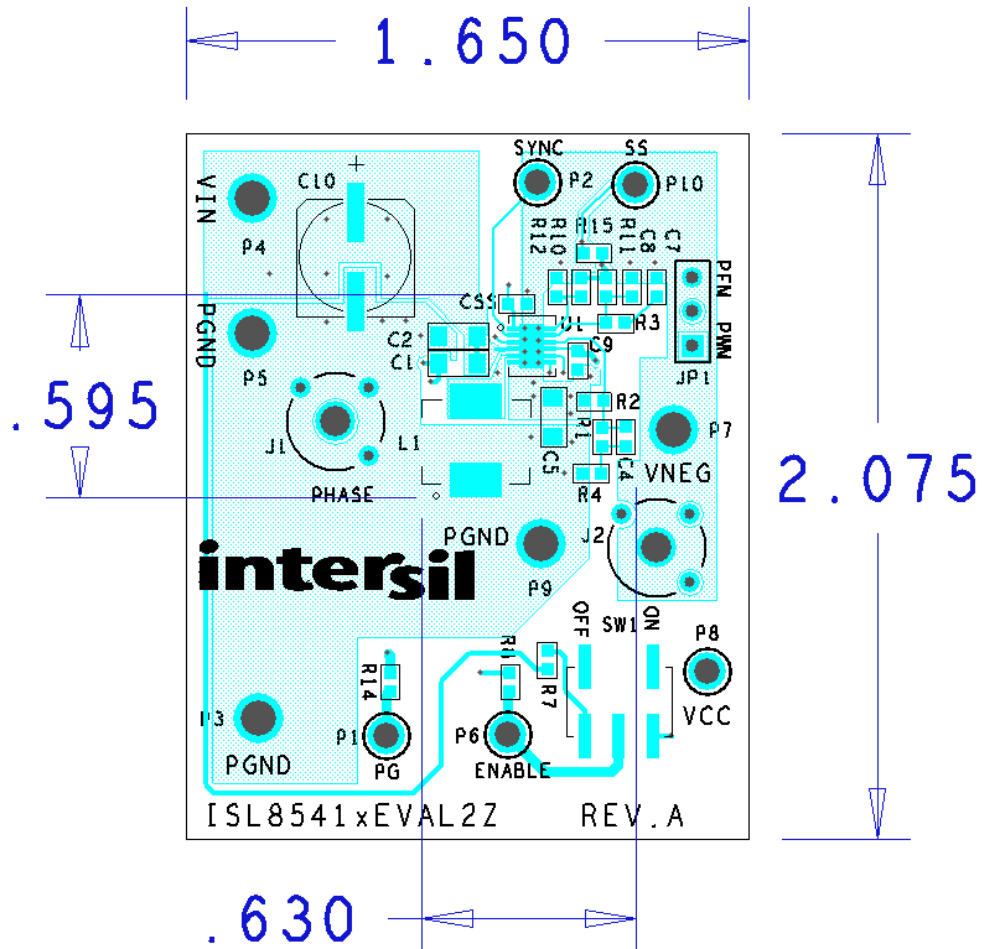

FIGURE 3. TOP



ISL85415EVAL2Z Board Layout (Continued)

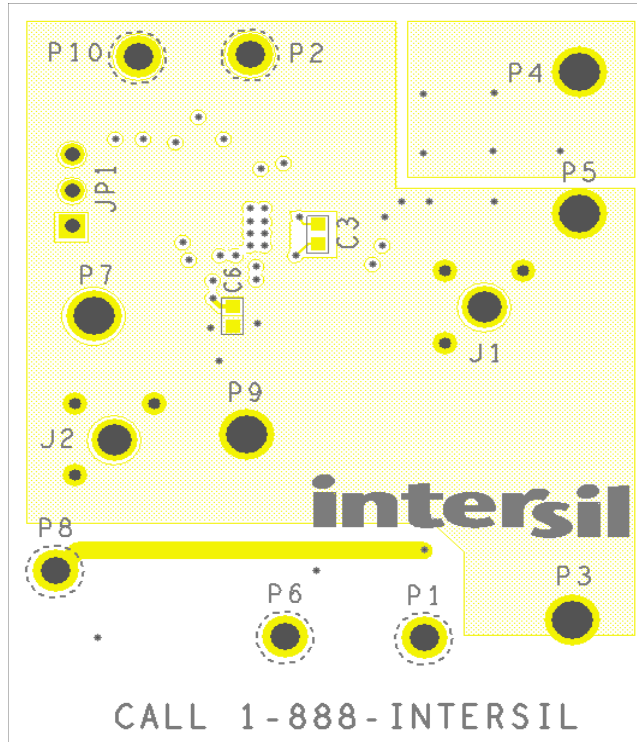

FIGURE 4. BOTTOM

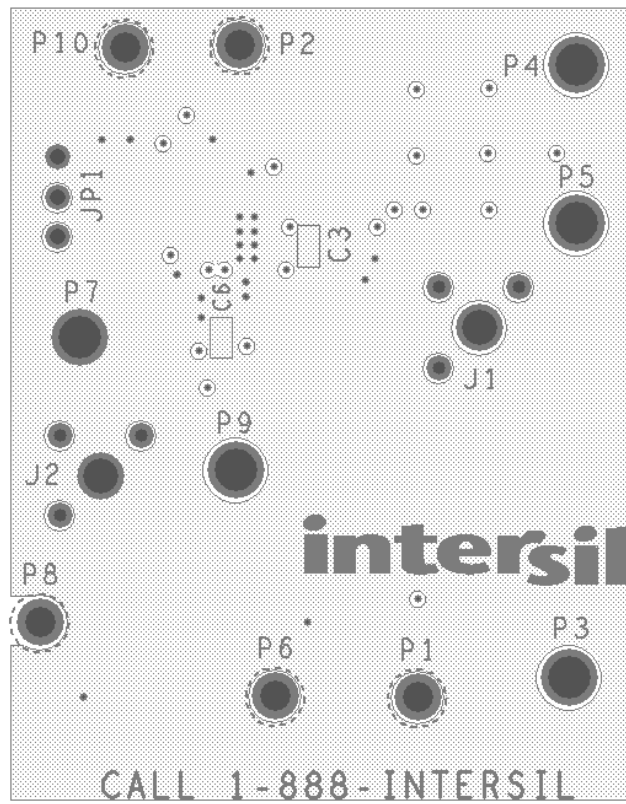

FIGURE 5. LAYER 2

ISL85415EVAL2Z Board Layout (continued)

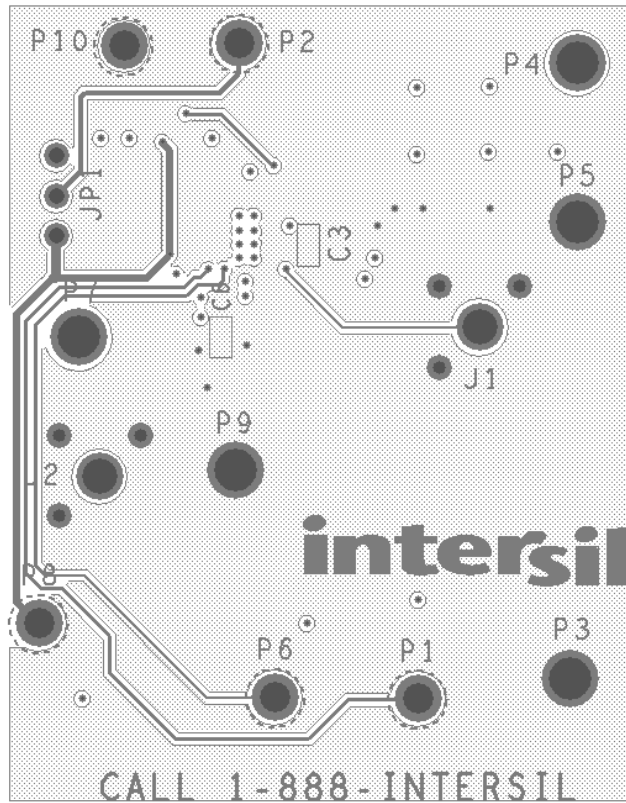

FIGURE 6. LAYER 3



## Typical Performance Curves

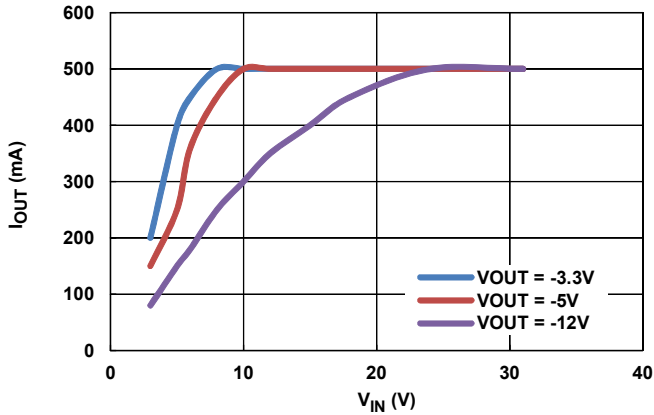

FIGURE 7. MAXIMUM  $I_{OUT}$  VS  $V_{IN}$ ,  $-V_{OUT}$

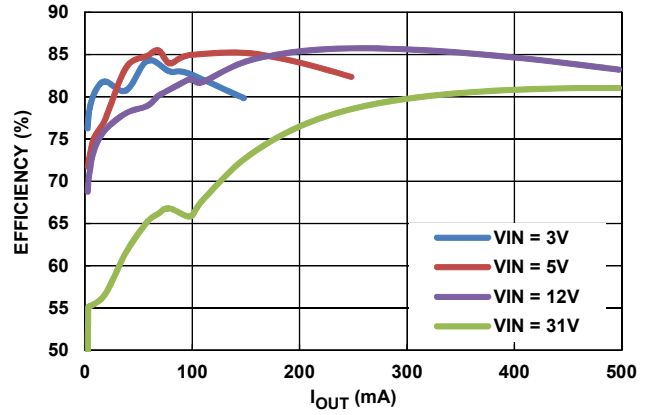

FIGURE 8. PFM EFFICIENCY,  $V_{OUT} = -5V$

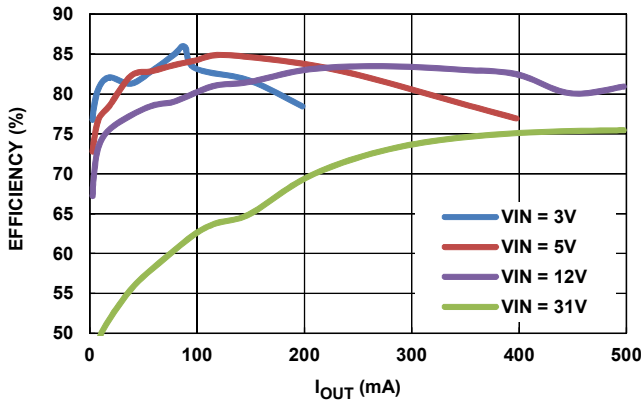

FIGURE 9. PFM EFFICIENCY,  $V_{OUT} = -3.3V$

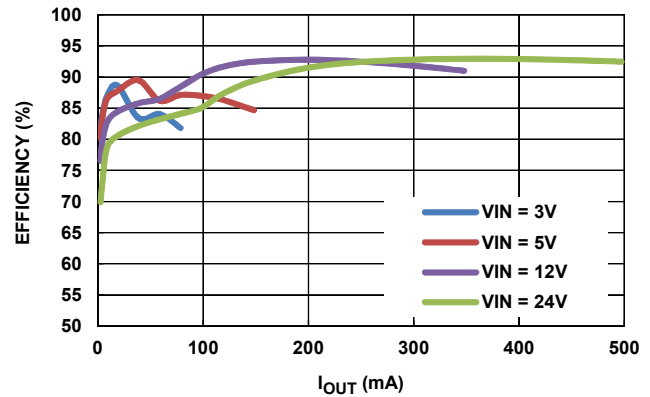

FIGURE 10. PFM EFFICIENCY,  $V_{OUT} = -12V$

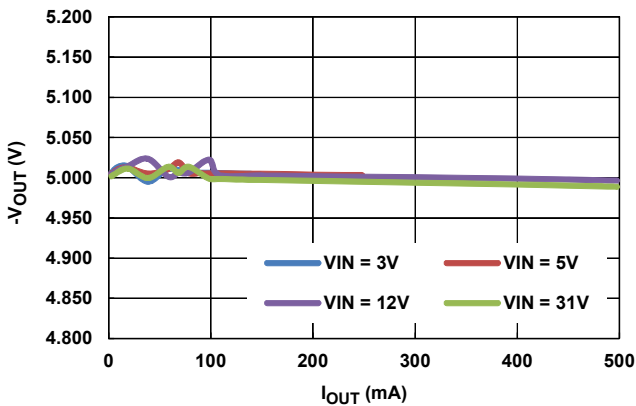

FIGURE 11. PFM LOAD REGULATION,  $V_{OUT} = -5V$

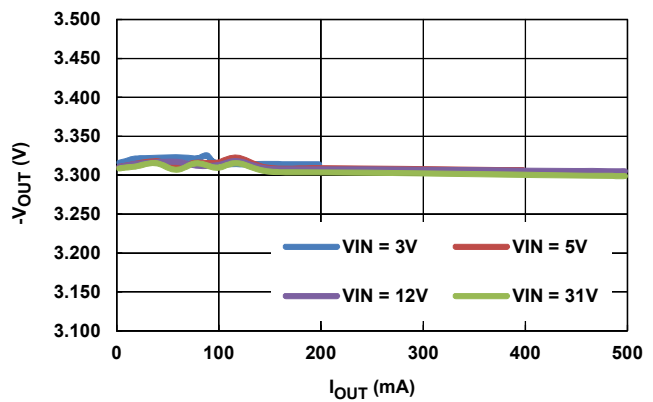

FIGURE 12. PFM LOAD REGULATION,  $V_{OUT} = -3.3V$

## Typical Performance Curves (Continued)

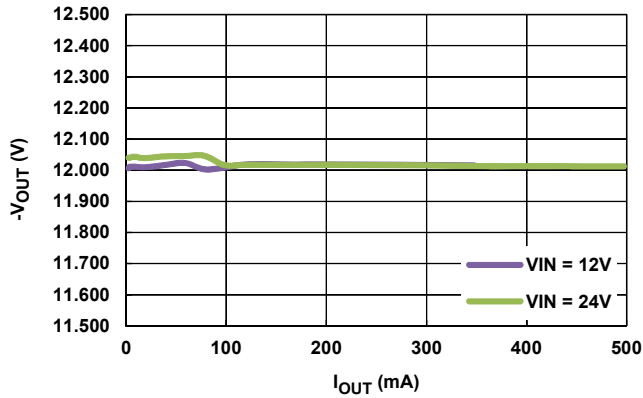

FIGURE 13. PFM LOAD REGULATION,  $V_{OUT} = -12V$

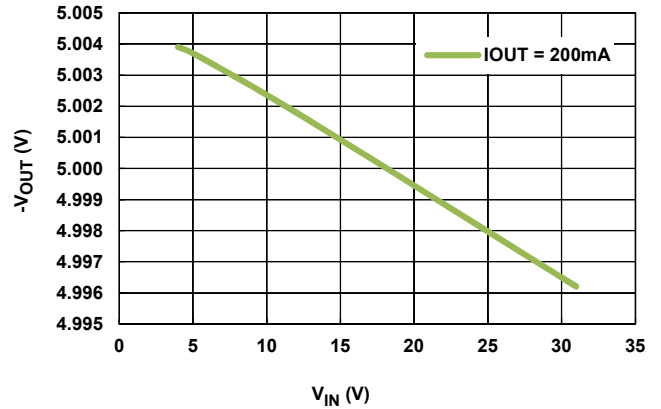

FIGURE 14. PFM LINE REGULATION,  $V_{OUT} = -5V$ ,  $I_{OUT} = 200mA$

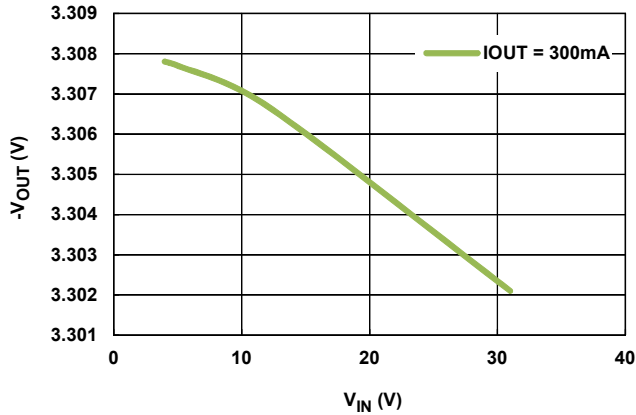

FIGURE 15. PFM LINE REGULATION,  $V_{OUT} = -3.3V$ ,  $I_{OUT} = 300mA$

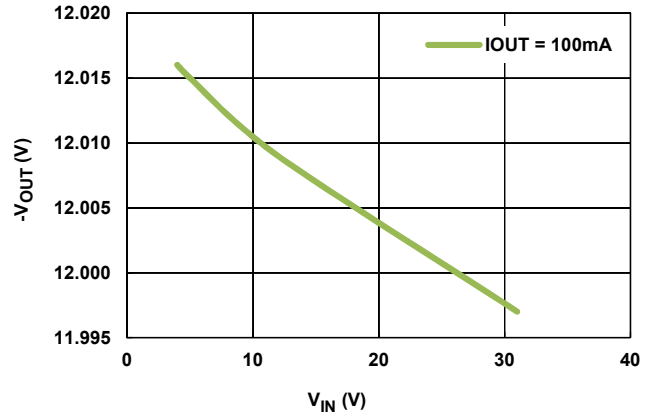

FIGURE 16. PFM LINE REGULATION,  $V_{OUT} = -12V$ ,  $I_{OUT} = 100mA$

## Typical Performance Curves

$V_{IN} = 24V$ ,  $V_{OUT} = -5V$ , MODE = PWM, FSW = 800kHz,  $T_A = +25^\circ C$

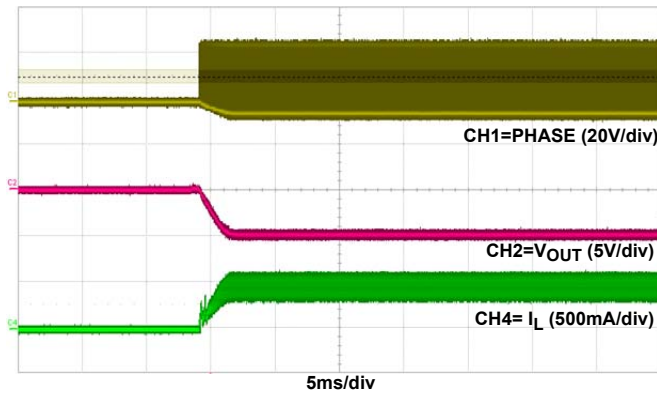

FIGURE 17. STARTUP AT 500MA

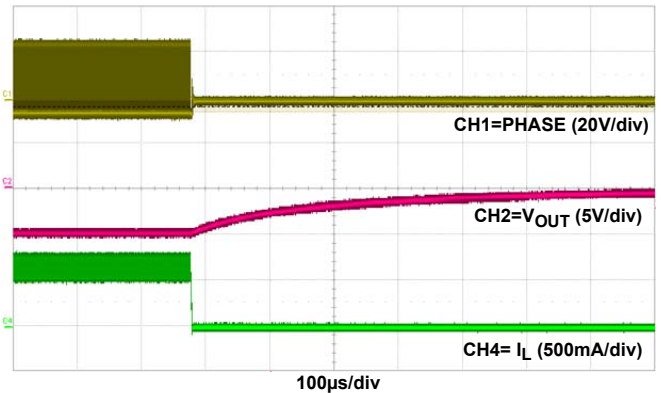

FIGURE 18. SHUTDOWN AT 500MA

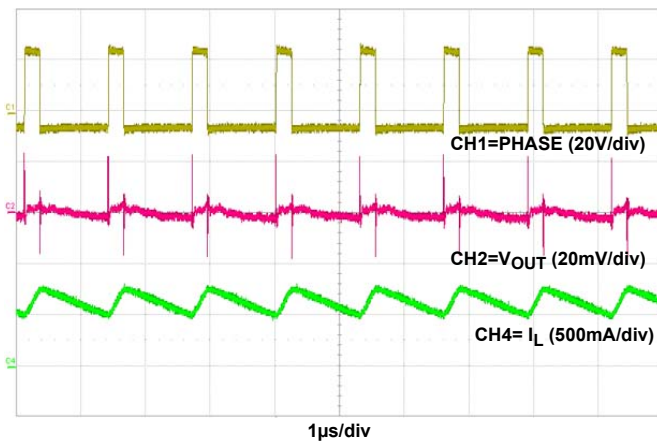

FIGURE 19. STEADY STATE AT 500MA LOAD

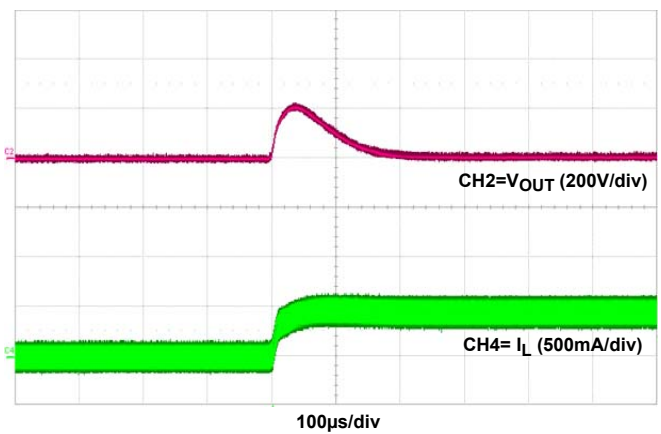

FIGURE 20. LOAD TRANSIENT

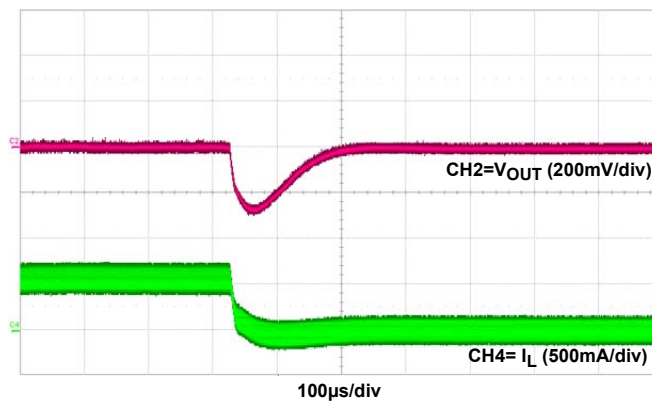

FIGURE 21. LOAD TRANSIENT

Intersil Corporation reserves the right to make changes in circuit design, software and/or specifications at any time without notice. Accordingly, the reader is cautioned to verify that the document is current before proceeding.

For information regarding Intersil Corporation and its products, see [www.intersil.com](http://www.intersil.com)