

TYPICAL SWITCH ORDERING EXAMPLE

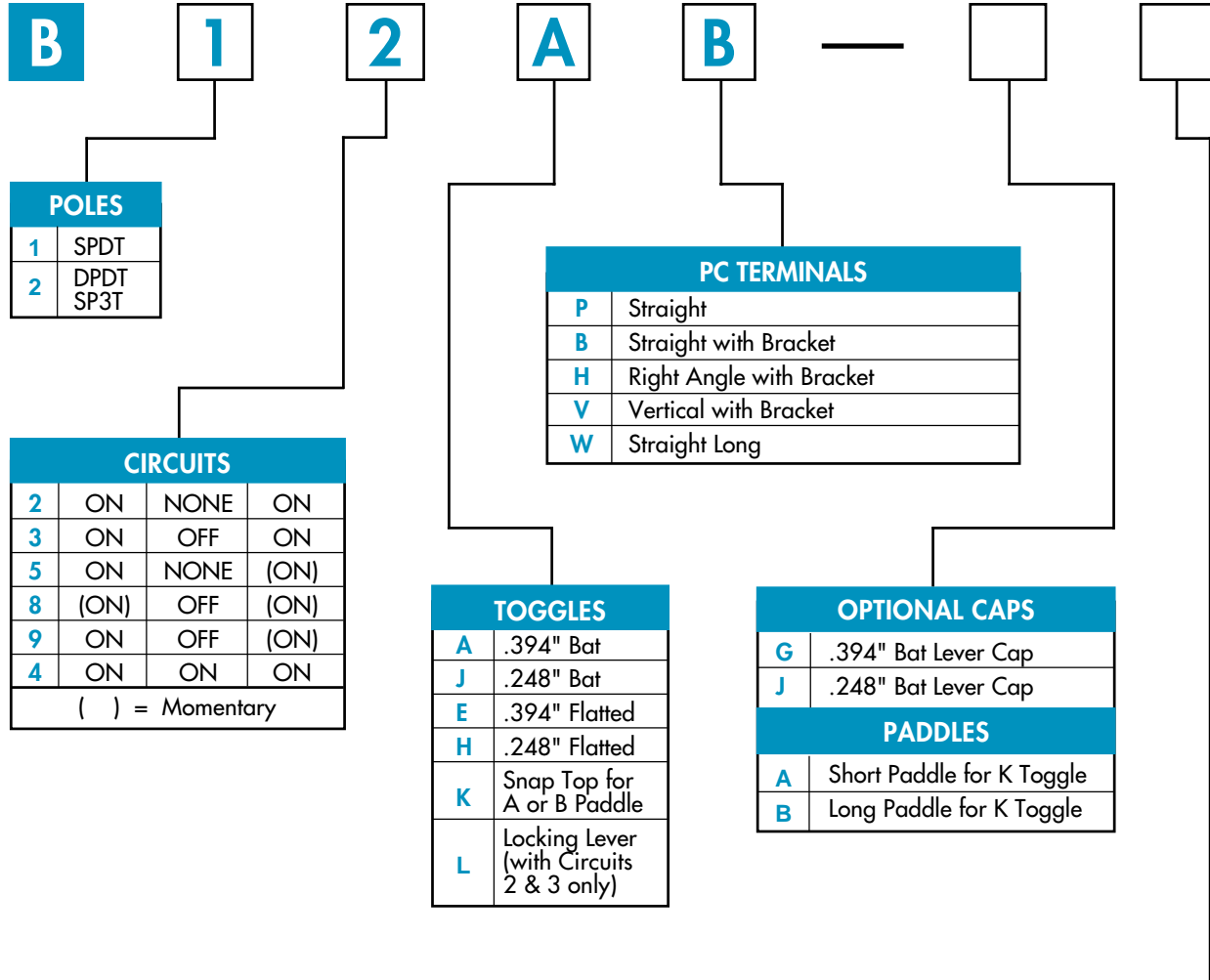

POLES	
1	SPDT
2	DPDT SP3T

CIRCUITS			
2	ON	NONE	ON
3	ON	OFF	ON
5	ON	NONE	(ON)
8	(ON)	OFF	(ON)
9	ON	OFF	(ON)
4	ON	ON	ON
() = Momentary			

PC TERMINALS	
P	Straight
B	Straight with Bracket
H	Right Angle with Bracket
V	Vertical with Bracket
W	Straight Long

TOGGLES	
A	.394" Bat
J	.248" Bat
E	.394" Flatted
H	.248" Flatted
K	Snap Top for A or B Paddle
L	Locking Lever (with Circuits 2 & 3 only)

OPTIONAL CAPS	
G	.394" Bat Lever Cap
J	.248" Bat Lever Cap
PADDLES	
A	Short Paddle for K Toggle
B	Long Paddle for K Toggle

DESCRIPTION FOR TYPICAL ORDERING EXAMPLE

B12AB

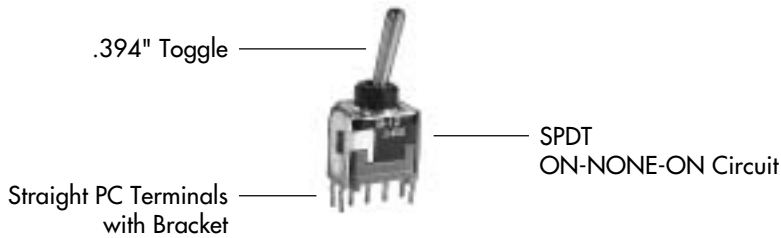

CAP COLORS		PADDLE COLORS	
A	Black	A	
B	White	B	
C	Red	C	
---	Yellow	E	
---	Green	F	
---	Blue	G	
---	Gray	H	

GENERAL SPECIFICATIONS

Electrical Capacity (Resistive Load)

Logic Level: 0.4VA maximum @ 28V AC/DC maximum
(Applicable Range 0.1mA ~ 0.1A @ 20mV ~ 28V)
Note: See Supplement Index (page Z1) to find explanation of operating range.

Other Ratings

Contact Resistance: 50 milliohms maximum
Insulation Resistance: 500 megohms minimum @ 500V DC
Dielectric Strength: 500V AC minimum
Mechanical Life: 100,000 operations minimum for On-None-On & On-Off-On
 50,000 operations minimum for other circuits
 50,000 operations minimum for locking lever models
Electrical Life: 50,000 operations minimum
Static Capability: Withstands 3 kilovolts ESD
Nominal Operating Force: Toggles A & E & K w/Long Paddle: 150 grams (momentary); 120 grams (maintained)
 Toggles J & H & K w/Short Paddle: 278 grams (momentary); 188 grams (maintained)
 Toggle L: 60 grams
Contact Timing: Nonshorting
Angle of Throw: 26°

Materials & Finishes

Toggle: Nickel plated brass
Bushing: Carbon blended polyamide; nickel plated zinc alloy for locking levers
Case Housing: Glass fiber reinforced polyamide
Support Bracket: Tin plated phosphor bronze
Movable Contact: Phosphor bronze with gold plating over silver plating
Stationary Contacts: Brass with gold plating over nickel undercoating
Terminals: Brass with gold plating over nickel undercoating

Environmental Data

Operating Temp Range: -30°C through +85°C (-22°F through +185°F)
Humidity: 90 ~ 95% humidity for 96 hours @ 40°C (104°F)
Vibration: 10 ~ 55Hz with peak-to-peak amplitude of 1.5mm traversing the frequency range & returning in 1 minute; 3 right angled directions for 2 hours
Shock: 50g acceleration (tested in 6 right angled directions, with 5 shocks in each direction)









Installation

Soldering Time & Temperature: 3 seconds @ 350°C or 5 seconds @ 270°C
Process Seal: See Supplement Index (page Z1) for specific processing data.

Standards & Certifications

Flammability Standards: UL94V-0 available
IECQ Approved: All toggle models recognized at 0.4VA maximum @ 28V AC/DC maximum
 Qualification Approval Number: JP792-4A

POLES & CIRCUITS

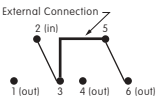
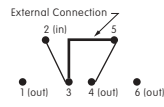
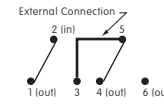
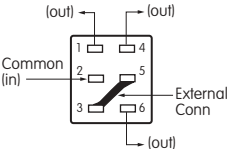

		Toggle Position () = Momentary			Connected Terminals			Throw & Schematics
Pole	Model	Up 	Center 	Down 	Up 	Center 	Down 	Note: Terminal numbers are not actually on the switch.
SP	B12 B13 B15 B18 B19	ON	NONE	ON	2-3	OPEN	2-1	SPDT 
DP	B22 B23 B25 B28 B29	ON	NONE	ON	2-3 5-6	OPEN	2-1 5-4	DPDT 

For 3 Throw (3-On)

		Connected Terminals			External Connection
Pole	Model	Down	Center	Up	
SP	B24	ON 	ON 	ON 	The SP3T model utilizes a double pole base. External connections must be made during field installation. 
		2-3 5-6	2-3 5-4	2-1 5-4	

TOGGLES

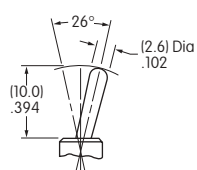
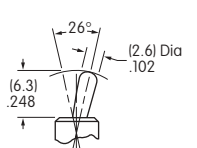
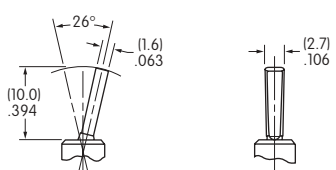
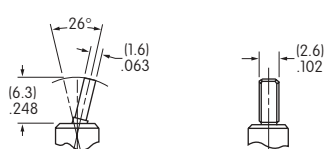
Standard Material & Finish: Brass with Bright Nickel

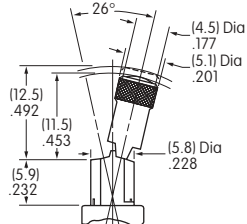
<p>A .394" Bat</p> 	<p>J .248" Bat</p> 	<p>E .394" Flatted</p> 
<p>H .248" Flatted</p> 	<p>K Snap Top for Paddles</p> 	<p>L Locking Lever</p> 

PC TERMINALS

Use of a support bracket or placement of the round bushing in a panel cutout is recommended to increase PCB mounting stability.

P Straight

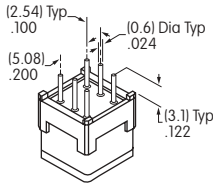

B Straight with Bracket

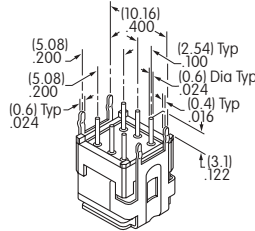

H Right Angle with Bracket

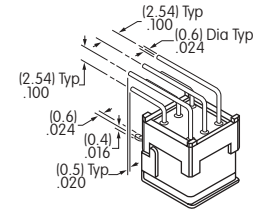

V Vertical with Bracket

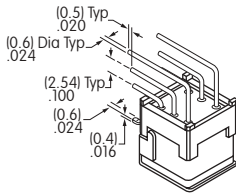

W Straight Long

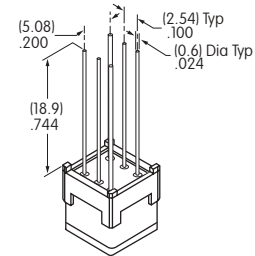

OPTIONAL CAPS

G AT4003 .394" Bat Lever Cap

Material: PVC

Colors Available:
A, B, C

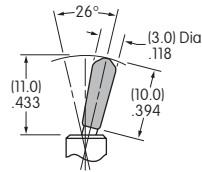

J AT4064 .248" Bat Lever Cap

Material: PVC

Colors Available:
A, B, C

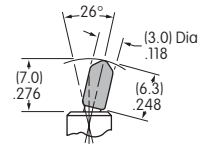

PADDLES

A AT467 Short Paddle

Material: PBT

Colors Available:
A, B, C, E, F, G, H

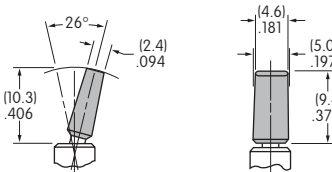

B AT468 Long Paddle

Material: PBT

Colors Available:
A, B, C, E, F, G, H

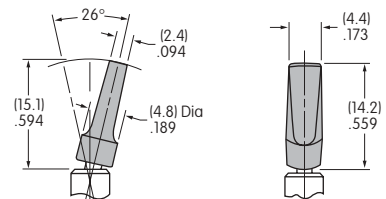

Color Codes: **A** Black **B** White **C** Red **E** Yellow **F** Green **G** Blue **H** Gray

TYPICAL SWITCH DIMENSIONS

Straight PC



B12AP

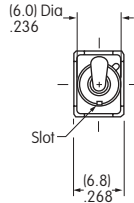

Single Pole

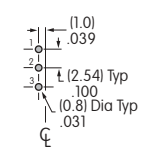
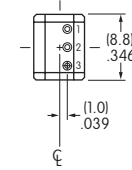
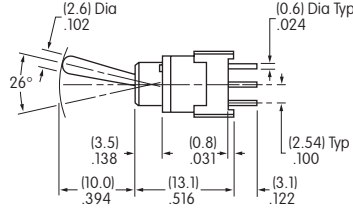

Straight PC



B22AP

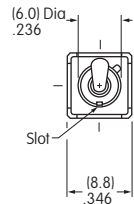

Double Pole

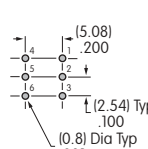
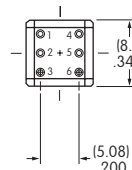
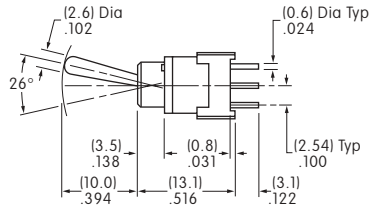

Straight PC • Bracket



B12AB

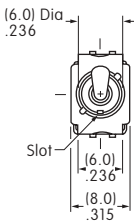

Single Pole

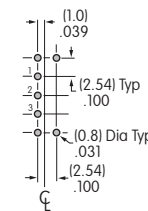
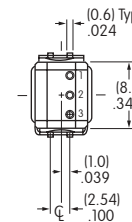
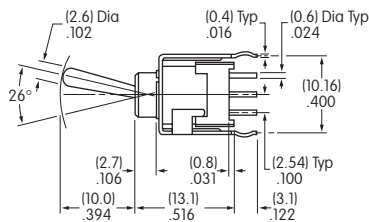

Straight PC • Bracket



B22AB

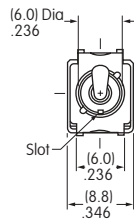

Double Pole

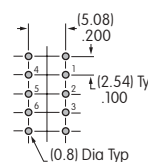
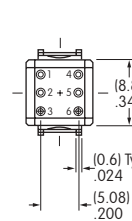
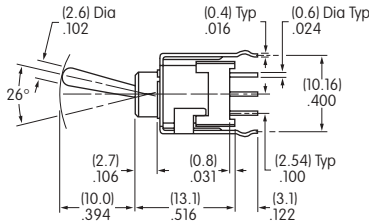

Right Angle PC



B12AH

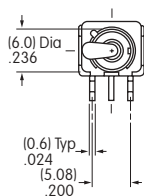

Single Pole

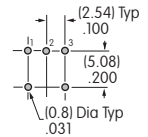
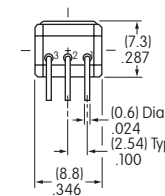
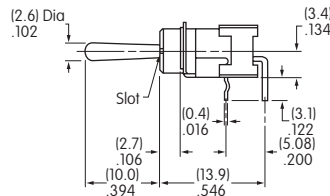

TYPICAL SWITCH DIMENSIONS

Right Angle PC



B22AH

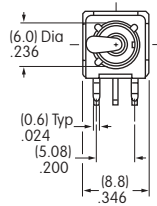

Double Pole

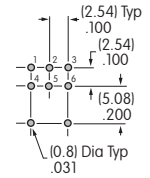
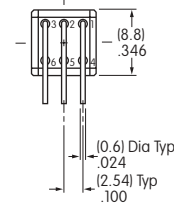
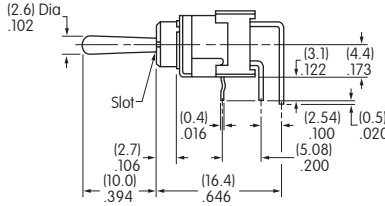

Vertical PC



B12AV

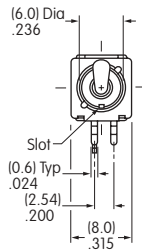

Single Pole

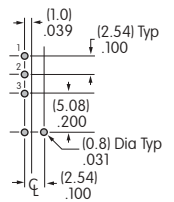
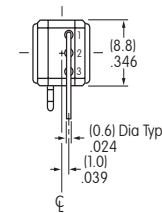
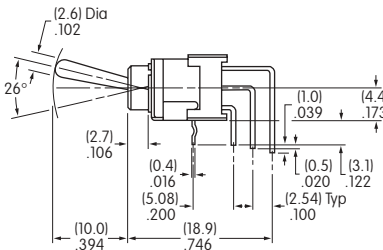

Vertical PC



B22AV

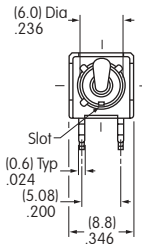

Double Pole

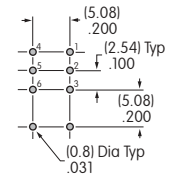
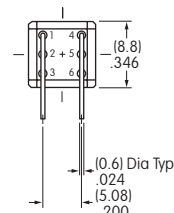
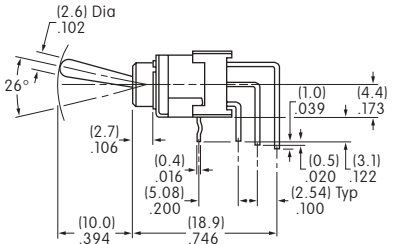

Locking Lever • Straight PC • Bracket



B12LB

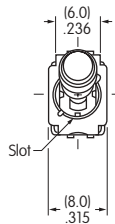

Single Pole

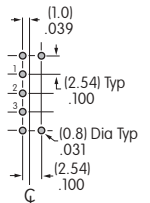
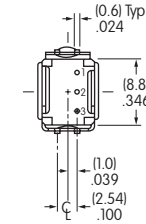
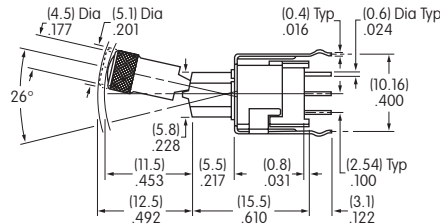

Locking Lever • Straight PC • Bracket



B22LB

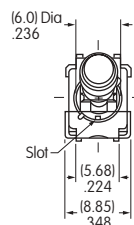

Double Pole

