

# RF LDMOS Wideband Integrated Power Amplifiers

The MWE6IC9100N wideband integrated circuit is designed with on-chip matching that makes it usable from 869 to 960 MHz. This multi-stage structure is rated for 26 to 32 Volt operation and covers all typical cellular base station modulations.

## Final Application

- Typical GSM Performance:  $V_{DD} = 26$  Volts,  $I_{DQ1} = 120$  mA,  $I_{DQ2} = 950$  mA,  $P_{out} = 100$  Watts CW,  $f = 960$  MHz  
Power Gain — 33.5 dB  
Power Added Efficiency — 54%

## GSM EDGE Application

- Typical GSM EDGE Performance:  $V_{DD} = 28$  Volts,  $I_{DQ1} = 230$  mA,  $I_{DQ2} = 870$  mA,  $P_{out} = 50$  Watts Avg., Full Frequency Band (869–960 MHz)  
Power Gain — 35.5 dB  
Power Added Efficiency — 39%  
Spectral Regrowth @ 400 kHz Offset = -63 dBc  
Spectral Regrowth @ 600 kHz Offset = -81 dBc  
EVM — 2% rms
- Capable of Handling 10:1 VSWR, @ 32 Vdc, 960 MHz, 3 dB Overdrive, Designed for Enhanced Ruggedness
- Stable into a 5:1 VSWR. All Spurs Below -60 dBc @ 1 mW to 120 W CW  $P_{out}$ .

## Features

- Characterized with Series Equivalent Large-Signal Impedance Parameters and Common Source S-Parameters
- On-Chip Matching (50 Ohm Input, DC Blocked)
- Integrated Quiescent Current Temperature Compensation with Enable/Disable Function (1)
- Integrated ESD Protection
- 225°C Capable Plastic Package
- RoHS Compliant
- In Tape and Reel. R1 Suffix = 500 Units per 44 mm, 13 inch Reel.

**MWE6IC9100NR1**  
**MWE6IC9100GNR1**  
**MWE6IC9100NBR1**

**960 MHz, 100 W, 26 V**  
**GSM/GSM EDGE**  
**RF LDMOS WIDEBAND**  
**INTEGRATED POWER AMPLIFIERS**

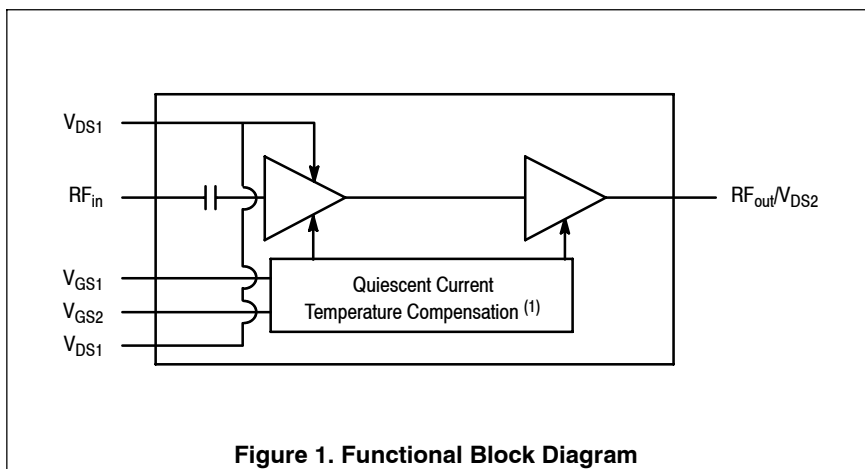
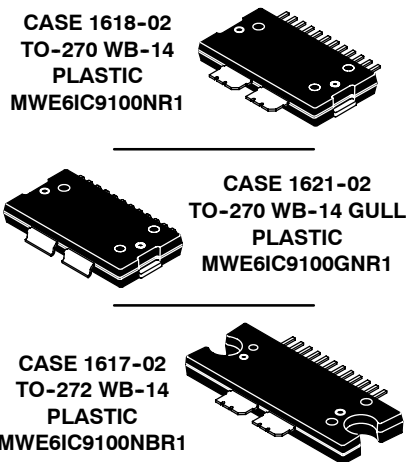


Figure 1. Functional Block Diagram

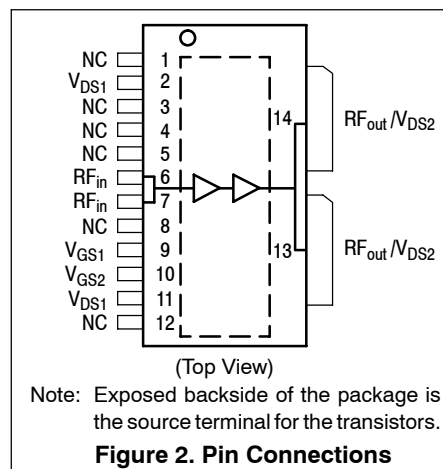


Figure 2. Pin Connections

1. Refer to AN1977, *Quiescent Current Thermal Tracking Circuit in the RF Integrated Circuit Family* and to AN1987, *Quiescent Current Control for the RF Integrated Circuit Device Family*. Go to <http://www.freescale.com/rf>. Select Documentation/Application Notes - AN1977 or AN1987.

**Table 1. Maximum Ratings**

Rating	Symbol	Value	Unit
Drain-Source Voltage	$V_{DS}$	-0.5, +66	Vdc
Gate-Source Voltage	$V_{GS}$	-0.5, +6	Vdc
Storage Temperature Range	$T_{stg}$	-65 to +150	°C
Case Operating Temperature	$T_C$	150	°C
Operating Junction Temperature (1,2)	$T_J$	225	°C

**Table 2. Thermal Characteristics**

Characteristic	Symbol	Value (2,3)	Unit
Thermal Resistance, Junction to Case	$R_{\theta JC}$		°C/W
GSM Application ( $P_{out} = 100$ W CW)	Stage 1, 26 Vdc, $I_{DQ1} = 120$ mA Stage 2, 26 Vdc, $I_{DQ2} = 950$ mA	1.82 0.38	
GSM EDGE Application ( $P_{out} = 50$ W Avg.)	Stage 1, 28 Vdc, $I_{DQ1} = 230$ mA Stage 2, 28 Vdc, $I_{DQ2} = 870$ mA	1.77 0.44	

**Table 3. ESD Protection Characteristics**

Test Methodology	Class
Human Body Model (per JESD22-A114)	2 (Minimum)
Machine Model (per EIA/JESD22-A115)	B (Minimum)
Charge Device Model (per JESD22-C101)	III (Minimum)

**Table 4. Moisture Sensitivity Level**

Test Methodology	Rating	Package Peak Temperature	Unit
Per JESD 22-A113, IPC/JEDEC J-STD-020	3	260	°C

**Table 5. Electrical Characteristics** ( $T_C = 25^\circ\text{C}$  unless otherwise noted)

Characteristic	Symbol	Min	Typ	Max	Unit
<b>Stage 1 — Off Characteristics</b>					
Zero Gate Voltage Drain Leakage Current ( $V_{DS} = 66$ Vdc, $V_{GS} = 0$ Vdc)	$I_{DSS}$	—	—	10	$\mu\text{Adc}$
Zero Gate Voltage Drain Leakage Current ( $V_{DS} = 28$ Vdc, $V_{GS} = 0$ Vdc)	$I_{DSS}$	—	—	1	$\mu\text{Adc}$
Gate-Source Leakage Current ( $V_{GS} = 5$ Vdc, $V_{DS} = 0$ Vdc)	$I_{GSS}$	—	—	10	$\mu\text{Adc}$
<b>Stage 1 — On Characteristics</b>					
Gate Threshold Voltage ( $V_{DS} = 10$ Vdc, $I_D = 35$ $\mu\text{Adc}$ )	$V_{GS(th)}$	1.5	2	3.5	Vdc
Gate Quiescent Voltage ( $V_{DS} = 26$ Vdc, $I_D = 120$ mAdc)	$V_{GS(Q)}$	—	2.7	—	Vdc
Fixture Gate Quiescent Voltage ( $V_{DD} = 26$ Vdc, $I_D = 120$ mAdc, Measured in Functional Test)	$V_{GG(Q)}$	6	9.4	12	Vdc

1. Continuous use at maximum temperature will affect MTTF.
2. MTTF calculator available at <http://www.freescale.com/rf>. Select Software & Tools/Development Tools/Calculators to access MTTF calculators by product.
3. Refer to AN1955, *Thermal Measurement Methodology of RF Power Amplifiers*. Go to <http://www.freescale.com/rf>. Select Documentation/Application Notes - AN1955.

(continued)

**Table 5. Electrical Characteristics** ( $T_C = 25^\circ\text{C}$  unless otherwise noted) (continued)

Characteristic	Symbol	Min	Typ	Max	Unit
<b>Stage 2 — Off Characteristics</b>					
Zero Gate Voltage Drain Leakage Current ( $V_{DS} = 66\text{ Vdc}$ , $V_{GS} = 0\text{ Vdc}$ )	$I_{DSS}$	—	—	10	$\mu\text{Adc}$
Zero Gate Voltage Drain Leakage Current ( $V_{DS} = 28\text{ Vdc}$ , $V_{GS} = 0\text{ Vdc}$ )	$I_{DSS}$	—	—	1	$\mu\text{Adc}$
Gate-Source Leakage Current ( $V_{GS} = 5\text{ Vdc}$ , $V_{DS} = 0\text{ Vdc}$ )	$I_{GSS}$	—	—	10	$\mu\text{Adc}$

**Stage 2 — On Characteristics**

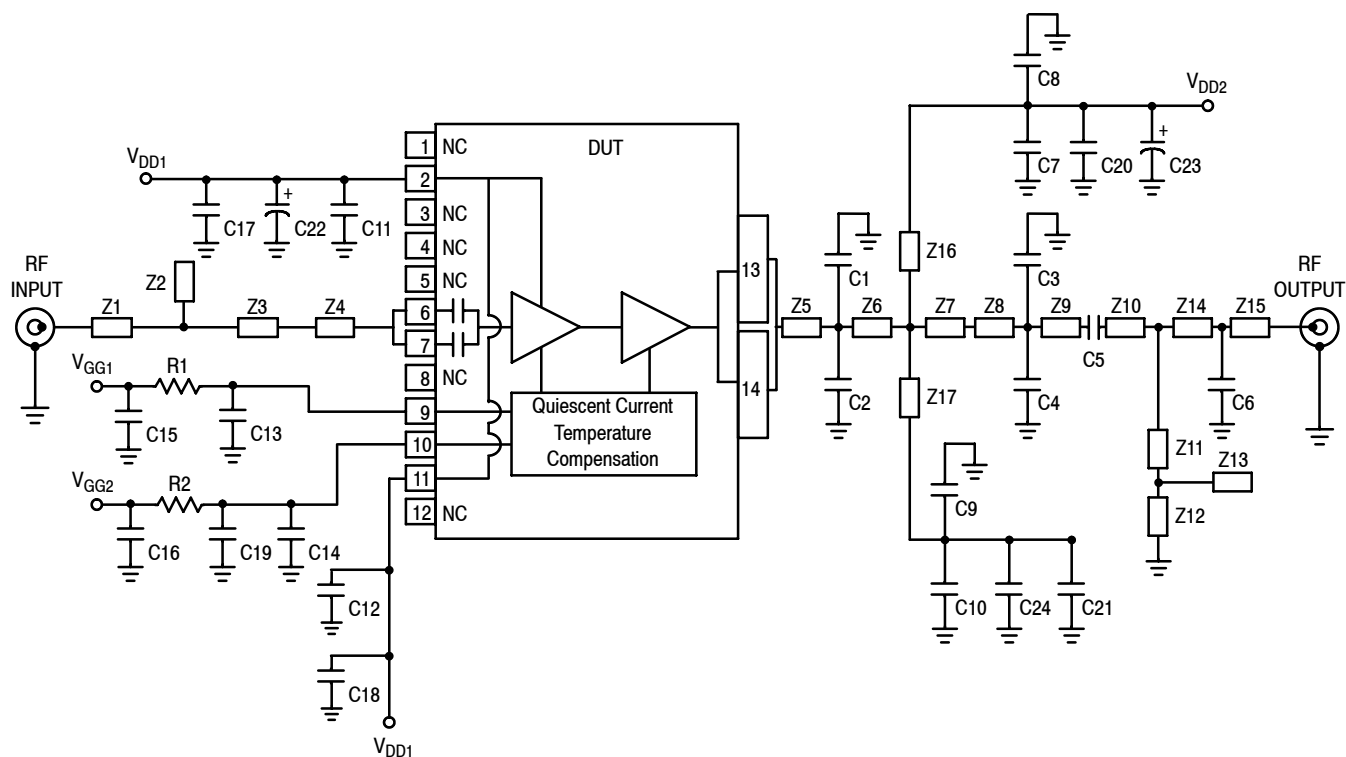
Gate Threshold Voltage ( $V_{DS} = 10\text{ Vdc}$ , $I_D = 290\ \mu\text{Adc}$ )	$V_{GS(th)}$	1.5	2	3.5	Vdc
Gate Quiescent Voltage ( $V_{DS} = 26\text{ Vdc}$ , $I_D = 950\text{ mAdc}$ )	$V_{GS(Q)}$	—	2.7	—	Vdc
Fixture Gate Quiescent Voltage ( $V_{DD} = 26\text{ Vdc}$ , $I_D = 950\text{ mAdc}$ , Measured in Functional Test)	$V_{GG(Q)}$	6	8.6	12	Vdc
Drain-Source On-Voltage ( $V_{GS} = 10\text{ Vdc}$ , $I_D = 1\text{ Adc}$ )	$V_{DS(on)}$	0.05	0.4	0.8	Vdc

**Functional Tests** (In Freescale Test Fixture, 50 ohm system)  $V_{DD} = 26\text{ Vdc}$ ,  $P_{out} = 100\text{ W CW}$ ,  $I_{DQ1} = 120\text{ mA}$ ,  $I_{DQ2} = 950\text{ mA}$ ,  $f = 960\text{ MHz}$ 

Power Gain	$G_{ps}$	31	33.5	36	dB
Input Return Loss	IRL	—	-15	-10	dB
Power Added Efficiency	PAE	52	54	—	%
$P_{out}$ @ 1 dB Compression Point, CW	P1dB	100	112	—	W

**Typical GSM EDGE Performances** (In Freescale GSM EDGE Test Fixture, 50 ohm system)  $V_{DD} = 28\text{ Vdc}$ ,  $P_{out} = 50\text{ W Avg.}$ ,  $I_{DQ1} = 230\text{ mA}$ ,  $I_{DQ2} = 870\text{ mA}$ , 869-894 MHz and 920-960 MHz EDGE Modulation

Power Gain	$G_{ps}$	—	35.5	—	dB
Power Added Efficiency	PAE	—	39	—	%
Error Vector Magnitude	EVM	—	2	—	% rms
Spectral Regrowth at 400 kHz Offset	SR1	—	-63	—	dBc
Spectral Regrowth at 600 kHz Offset	SR2	—	-81	—	dBc



Z1	0.089" x 0.083" Microstrip	Z10	0.117" x 0.083" Microstrip
Z2	0.157" x 0.315" Microstrip	Z11	0.067" x 0.431" Microstrip
Z3	0.157" x 0.397" Microstrip	Z12	0.067" x 0.084" Microstrip
Z4	0.139" x 0.060" Microstrip	Z13	0.381" x 0.067" Microstrip
Z5	0.024" x 0.386" Microstrip	Z14	0.418" x 0.084" Microstrip
Z6	0.352" x 0.902" Microstrip	Z15	0.421" x 0.084" Microstrip
Z7	0.039" x 0.607" Microstrip	Z16, Z17	2.550" x 0.157" Microstrip
Z8	0.555" x 1.102" Microstrip	PCB	Taconic TLX8-0300, 0.030", $\epsilon_r = 2.55$
Z9	0.343" x 0.083" Microstrip		

Figure 3. MWE6IC9100NR1(GNR1)(NBR1) Test Circuit Schematic

Table 6. MWE6IC9100NR1(GNR1)(NBR1) Test Circuit Component Designations and Values

Part	Description	Part Number	Manufacturer
C1, C2	10 pF Chip Capacitors	ATC100B100GT500XT	ATC
C3, C4, C5	3.9 pF Chip Capacitors	ATC100B3R9BT500XT	ATC
C6	0.5 pF Chip Capacitor	ATC100B0R5BT500XT	ATC
C7, C8, C9, C10, C11, C12, C13, C14	33 pF Chip Capacitors	ATC100B330JT500XT	ATC
C15, C16, C17, C18, C19, C20, C21	6.8 $\mu$ F Chip Capacitors	C4532X5R1H685MT	TDK
C22, C23	470 $\mu$ F, 63 V Electrolytic Capacitors, Radial	222212018470	Vishay
C24	330 pF Chip Capacitor	ATC100B331JT200XT	ATC
R1, R2	4.7 k $\Omega$ , 1/8 W Chip Resistors	CRCW08054701FKEA	Vishay

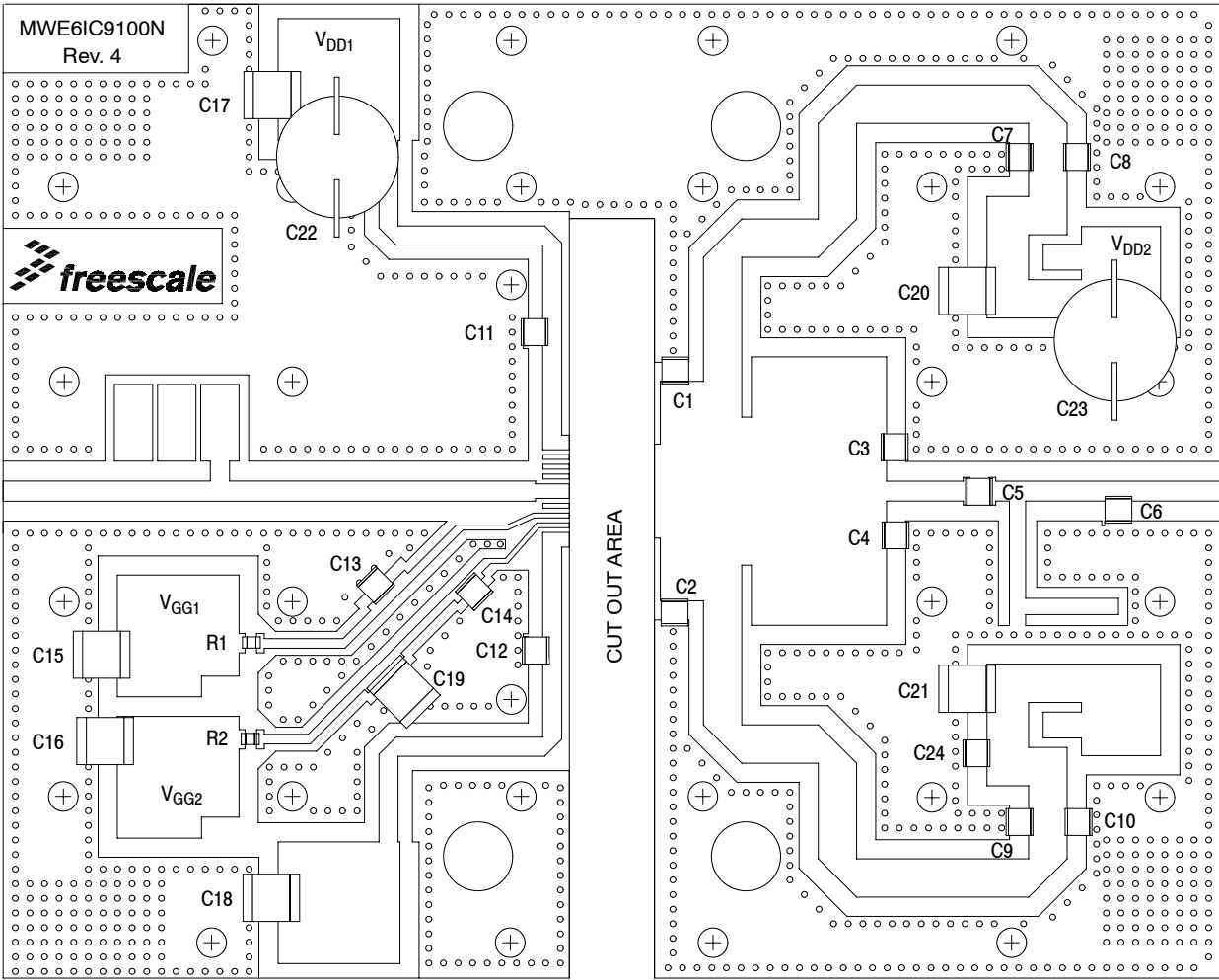


Figure 4. MWE6IC9100NR1(GNR1)(NBR1) Test Circuit Component Layout

### TYPICAL CHARACTERISTICS

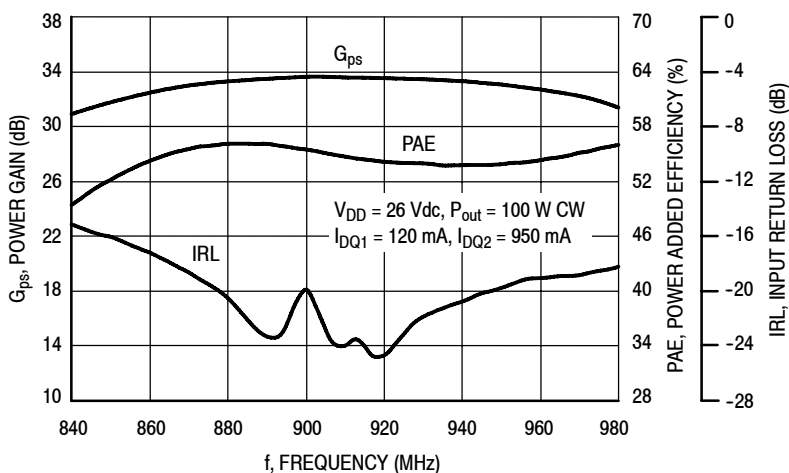


Figure 5. Power Gain, Input Return Loss and Power Added Efficiency versus Frequency @  $P_{out} = 100$  Watts CW

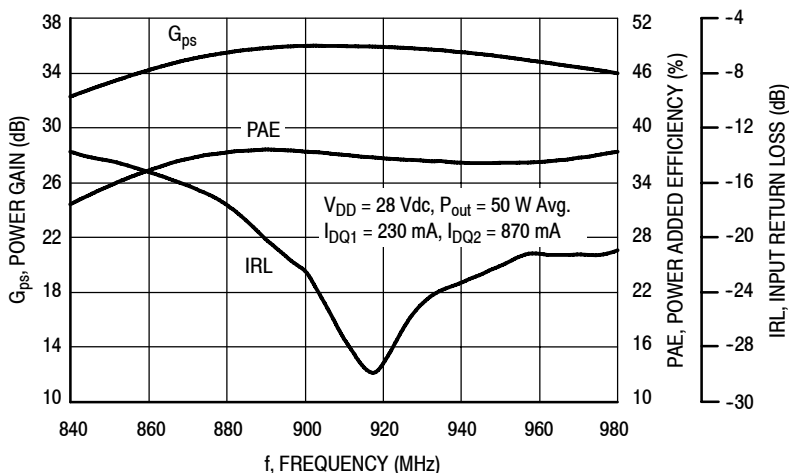


Figure 6. Power Gain, Input Return Loss and Power Added Efficiency versus Frequency @  $P_{out} = 50$  Watts Avg.

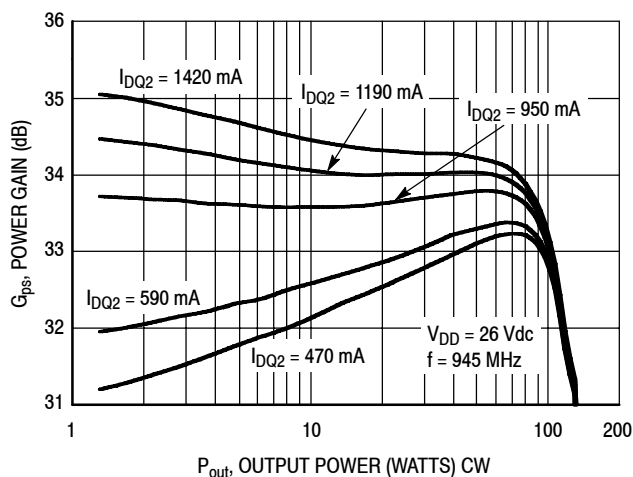


Figure 7. Power Gain versus Output Power @  $I_{DQ1} = 120$  mA

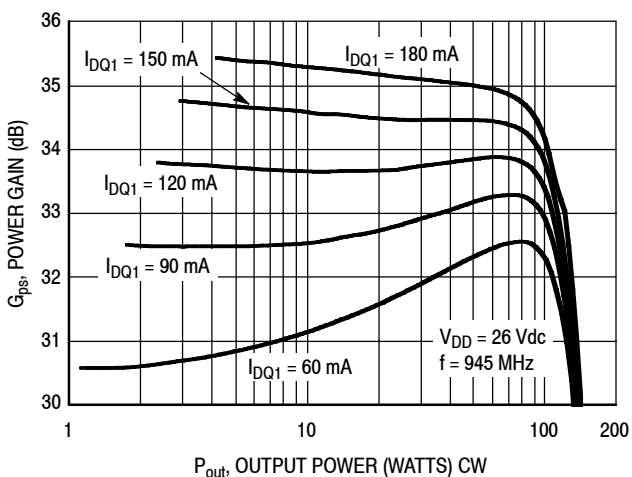
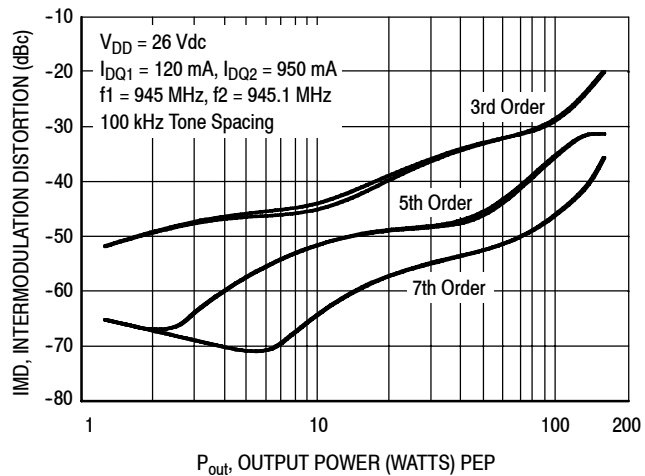
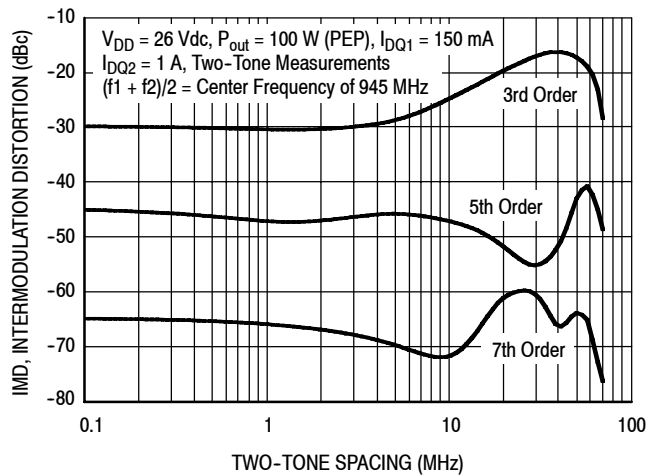


Figure 8. Power Gain versus Output Power @  $I_{DQ2} = 950$  mA

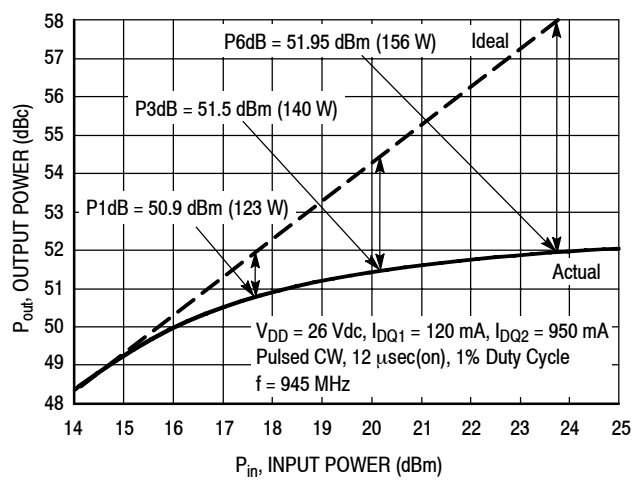
### TYPICAL CHARACTERISTICS



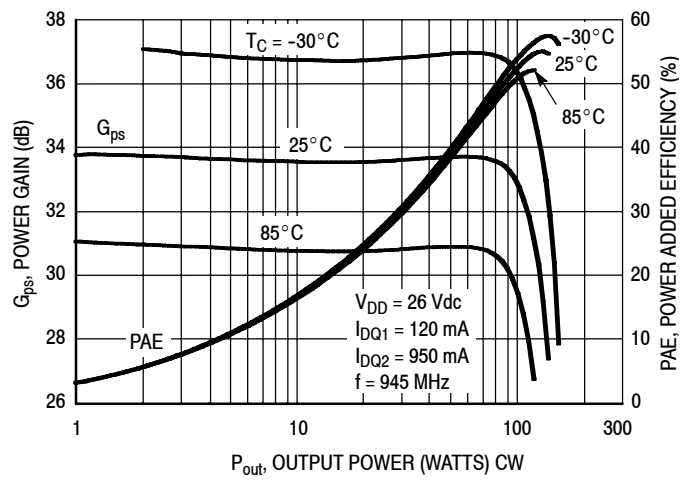
**Figure 9. Intermodulation Distortion Products versus Output Power**



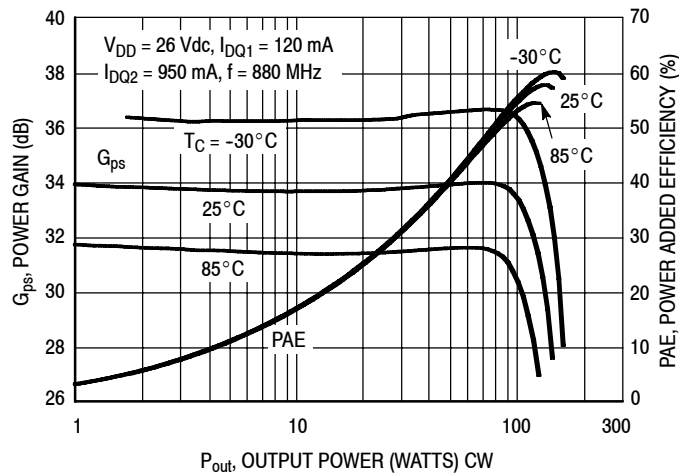
**Figure 10. Intermodulation Distortion Products versus Tone Spacing**



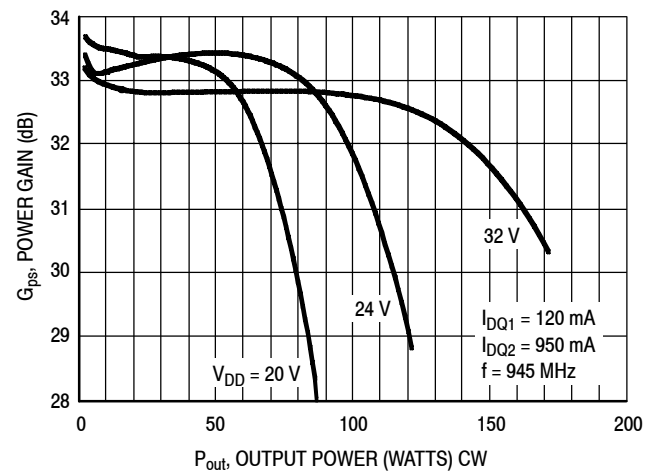
**Figure 11. Pulsed CW Output Power versus Input Power**



**Figure 12. Power Gain and Power Added Efficiency versus Output Power @ 945 MHz**



**Figure 13. Power Gain and Power Added Efficiency versus Output Power @ 880 MHz**



**Figure 14. Power Gain versus Output Power**

ARCHIVE INFORMATION

ARCHIVE INFORMATION

## TYPICAL CHARACTERISTICS

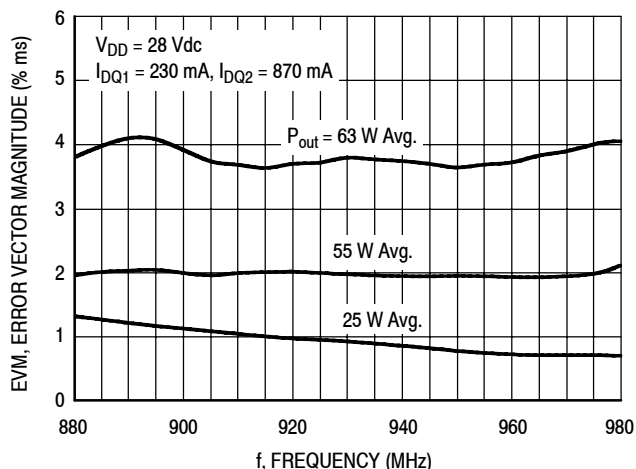


Figure 15. EVM versus Frequency

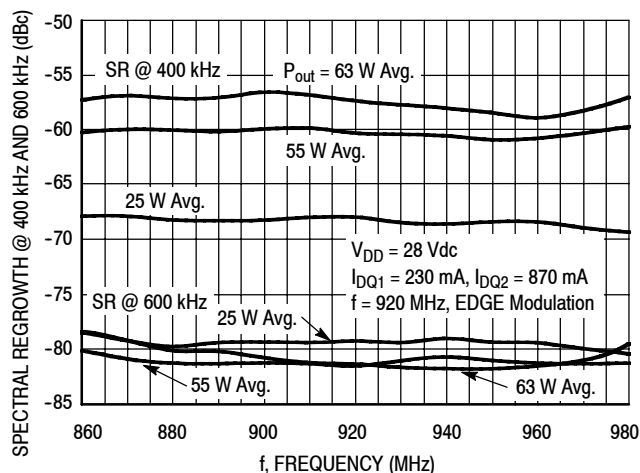


Figure 16. Spectral Regrowth at 400 kHz and 600 kHz versus Frequency

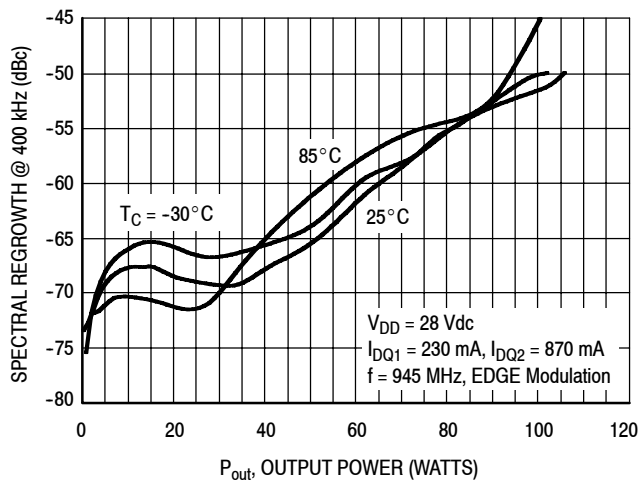


Figure 17. Spectral Regrowth at 400 kHz versus Output Power @ 945 MHz

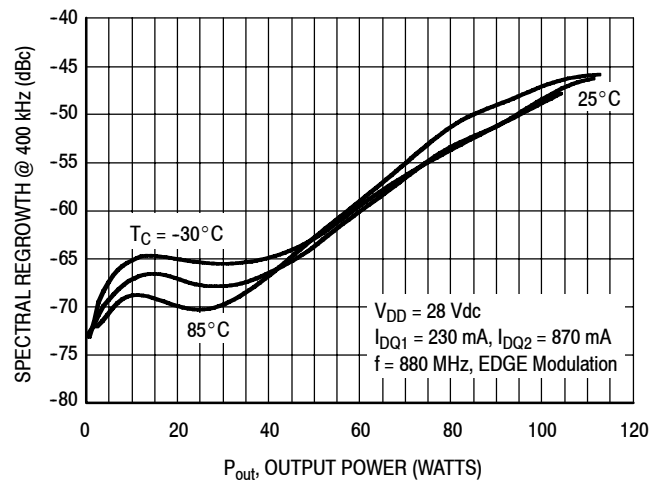


Figure 18. Spectral Regrowth at 400 kHz versus Output Power @ 880 MHz

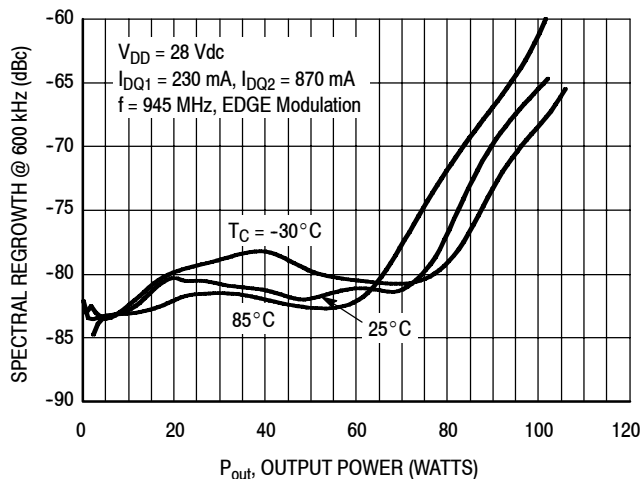


Figure 19. Spectral Regrowth at 600 kHz versus Output Power @ 945 MHz

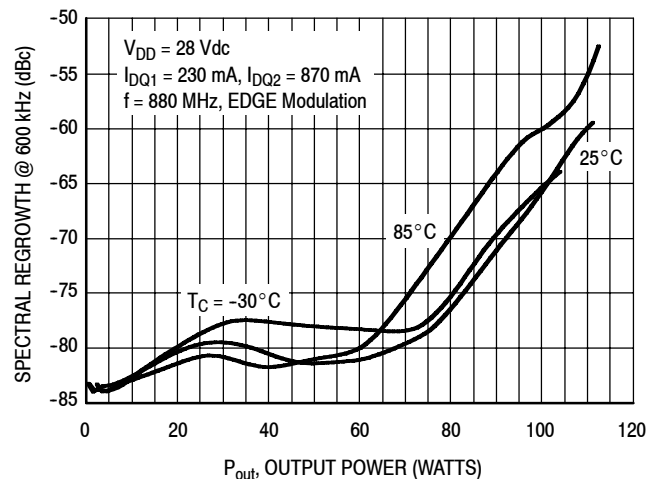
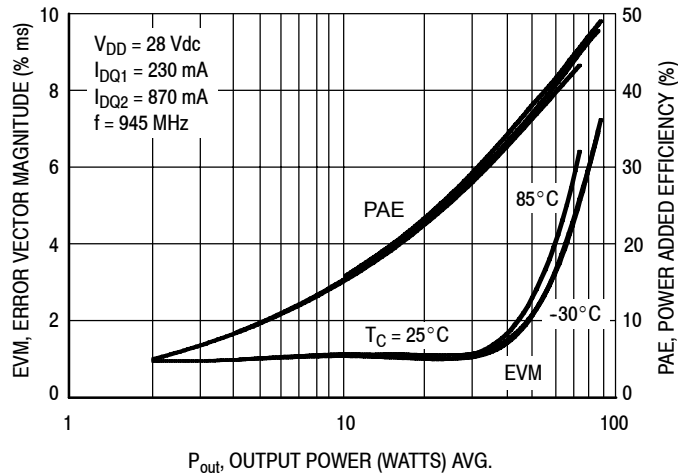


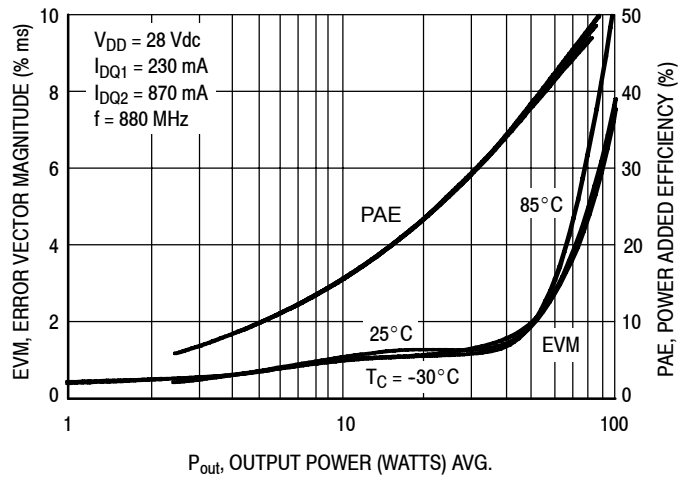
Figure 20. Spectral Regrowth at 600 kHz versus Output Power @ 880 MHz



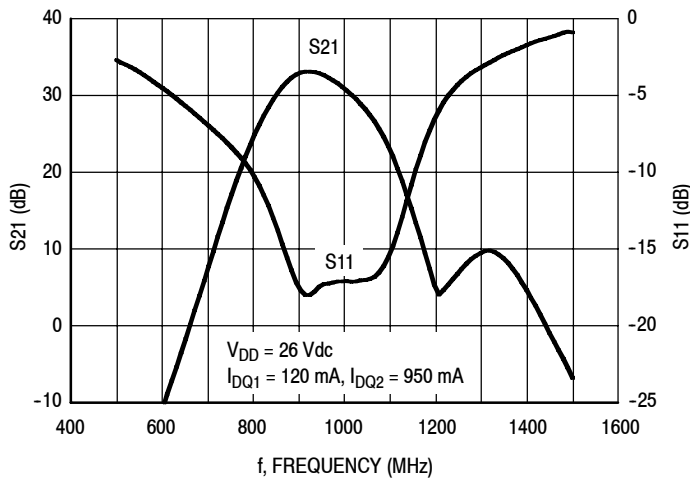
### TYPICAL CHARACTERISTICS



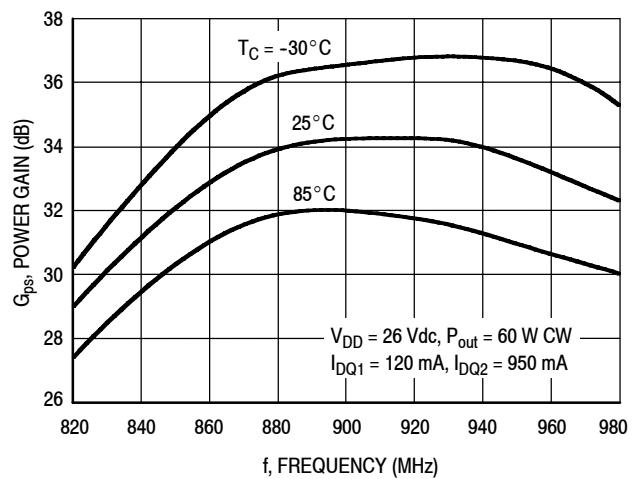
**Figure 21. EVM and Power Added Efficiency versus Output Power @ 945 MHz**



**Figure 22. EVM and Power Added Efficiency versus Output Power @ 880 MHz**

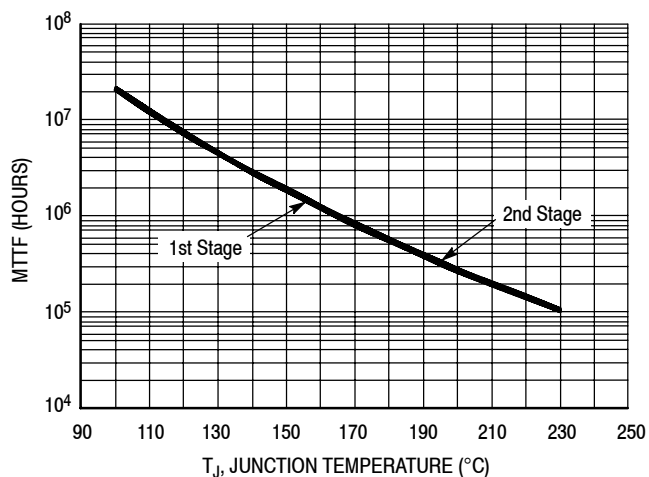


**Figure 23. Broadband Frequency Response**



**Figure 24. Power Gain versus Frequency**

### TYPICAL CHARACTERISTICS

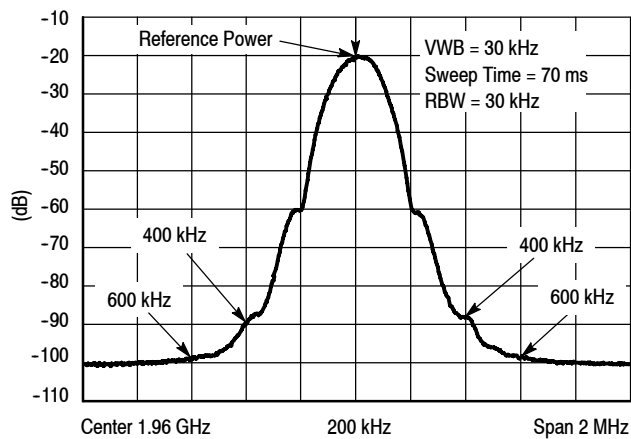


This above graph displays calculated MTTF in hours when the device is operated at  $V_{DD} = 26$  Vdc,  $P_{out} = 100$  W CW, and PAE = 54%.

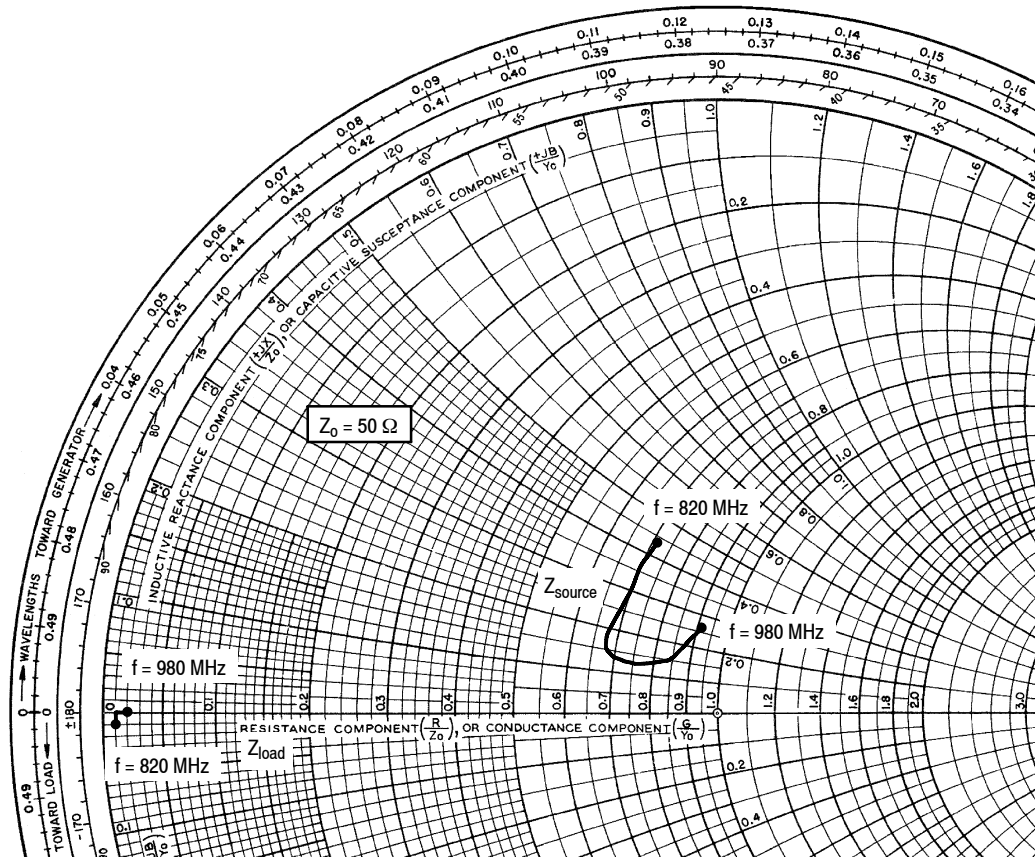
MTTF calculator available at <http://www.freescale.com/rf>. Select Software & Tools/Development Tools/Calculators to access MTTF calculators by product.

**Figure 25. MTTF versus Junction Temperature**

### GSM TEST SIGNAL



**Figure 26. EDGE Spectrum**



$V_{DD} = 26 \text{ Vdc}$ ,  $I_{DQ1} = 120 \text{ mA}$ ,  $I_{DQ2} = 950 \text{ mA}$ ,  $P_{out} = 100 \text{ W CW}$

f MHz	$Z_{source}$ $\Omega$	$Z_{load}$ $\Omega$
820	$35.40 + j21.50$	$0.516 - j0.365$
840	$35.00 + j18.00$	$0.638 - j0.172$
860	$35.00 + j15.50$	$0.768 - j0.010$
880	$34.50 + j12.20$	$0.874 + j0.071$
900	$34.00 + j9.00$	$1.030 + j0.133$
920	$34.30 + j7.20$	$1.101 + j0.082$
940	$38.50 + j6.00$	$1.088 + j0.037$
960	$42.00 + j7.40$	$1.011 + j0.018$
980	$45.55 + j12.75$	$0.872 + j0.051$

$Z_{source}$  = Test circuit impedance as measured from gate to ground.

$Z_{load}$  = Test circuit impedance as measured from drain to ground.

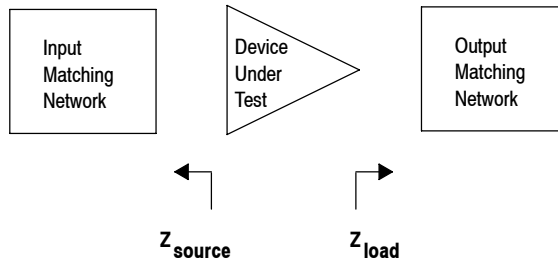


Figure 27. Series Equivalent Source and Load Impedance

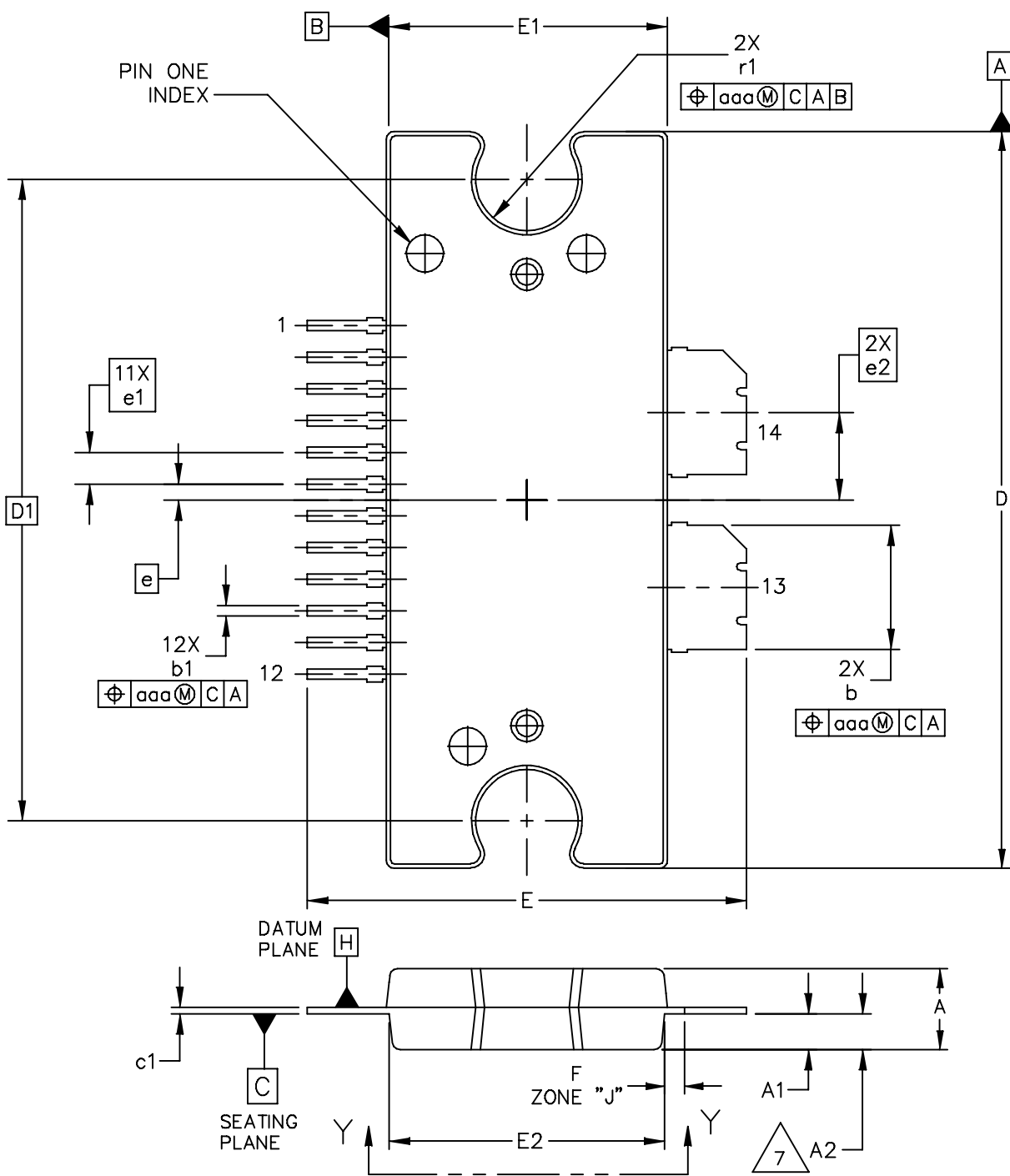
**Table 7. Common Source Scattering Parameters** ( $V_{DD} = 26$  V, 50 ohm system,  $I_{DQ1} = 120$  mA,  $I_{DQ2} = 950$  mA)

f MHz	S <sub>11</sub>		S <sub>21</sub>		S <sub>12</sub>		S <sub>22</sub>	
	S <sub>11</sub>	∠ φ	S <sub>21</sub>	∠ φ	S <sub>12</sub>	∠ φ	S <sub>22</sub>	∠ φ
750	0.230	95	5.81	-87	0.0007	-119	0.989	-180
760	0.188	93	6.48	-97	0.0007	-116	0.987	180
770	0.149	92	7.18	-107	0.0007	-111	0.985	180
780	0.114	92	7.88	-117	0.0007	-110	0.983	180
790	0.085	96	8.56	-128	0.0008	-109	0.981	180
800	0.063	104	9.22	-139	0.0008	-108	0.979	180
810	0.047	117	9.82	-150	0.0009	-109	0.978	180
820	0.037	134	10.37	-161	0.0009	-110	0.978	-180
830	0.031	156	10.85	-172	0.0009	-111	0.977	-180
840	0.029	-177	11.27	178	0.0010	-113	0.977	-180
850	0.033	-152	11.60	167	0.0010	-114	0.978	-180
860	0.041	-134	11.87	156	0.0010	-117	0.978	-180
870	0.052	-123	12.07	146	0.0010	-119	0.979	-180
880	0.063	-116	12.20	135	0.0010	-122	0.979	-180
890	0.074	-112	12.25	125	0.0010	-123	0.979	180
900	0.084	-109	12.23	115	0.0010	-126	0.980	180
910	0.094	-106	12.15	106	0.0010	-129	0.979	180
920	0.104	-103	12.01	96	0.0010	-131	0.978	180
930	0.113	-99	11.82	86	0.0009	-133	0.978	180
940	0.125	-95	11.57	77	0.0009	-135	0.977	180
950	0.141	-91	11.28	68	0.0008	-138	0.976	180
960	0.160	-88	10.97	59	0.0008	-136	0.976	180
970	0.183	-86	10.62	50	0.0007	-135	0.976	180
980	0.209	-85	10.23	42	0.0006	-133	0.976	180
990	0.238	-85	9.83	34	0.0006	-130	0.975	180
1000	0.268	-86	9.41	26	0.0006	-125	0.975	180

ARCHIVE INFORMATION

ARCHIVE INFORMATION

PACKAGE DIMENSIONS

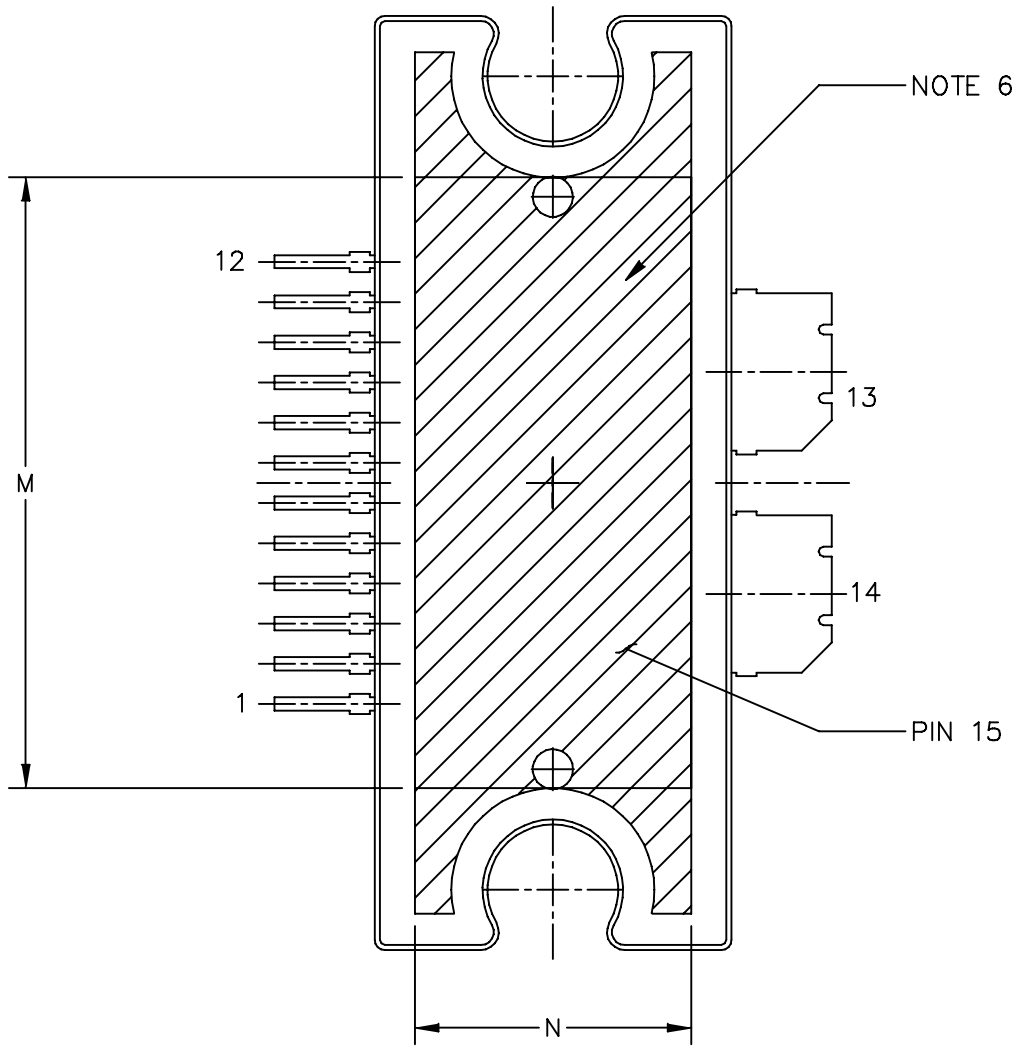


ARCHIVE INFORMATION

ARCHIVE INFORMATION

© FREESCALE SEMICONDUCTOR, INC. ALL RIGHTS RESERVED.		MECHANICAL OUTLINE	PRINT VERSION NOT TO SCALE
TITLE: TO-272 WIDE BODY 14 LEAD	DOCUMENT NO: 98ASA10649D		REV: A
	CASE NUMBER: 1617-02		27 JUN 2007
	STANDARD: NON-JEDEC		

MWE6IC9100NR1 MWE6IC9100GNR1 MWE6IC9100NBR1



VIEW Y-Y

© FREESCALE SEMICONDUCTOR, INC. ALL RIGHTS RESERVED.		MECHANICAL OUTLINE	PRINT VERSION NOT TO SCALE
TITLE: TO-272 WIDE BODY 14 LEAD	DOCUMENT NO: 98ASA10649D		REV: A
	CASE NUMBER: 1617-02		27 JUN 2007
	STANDARD: NON-JEDEC		

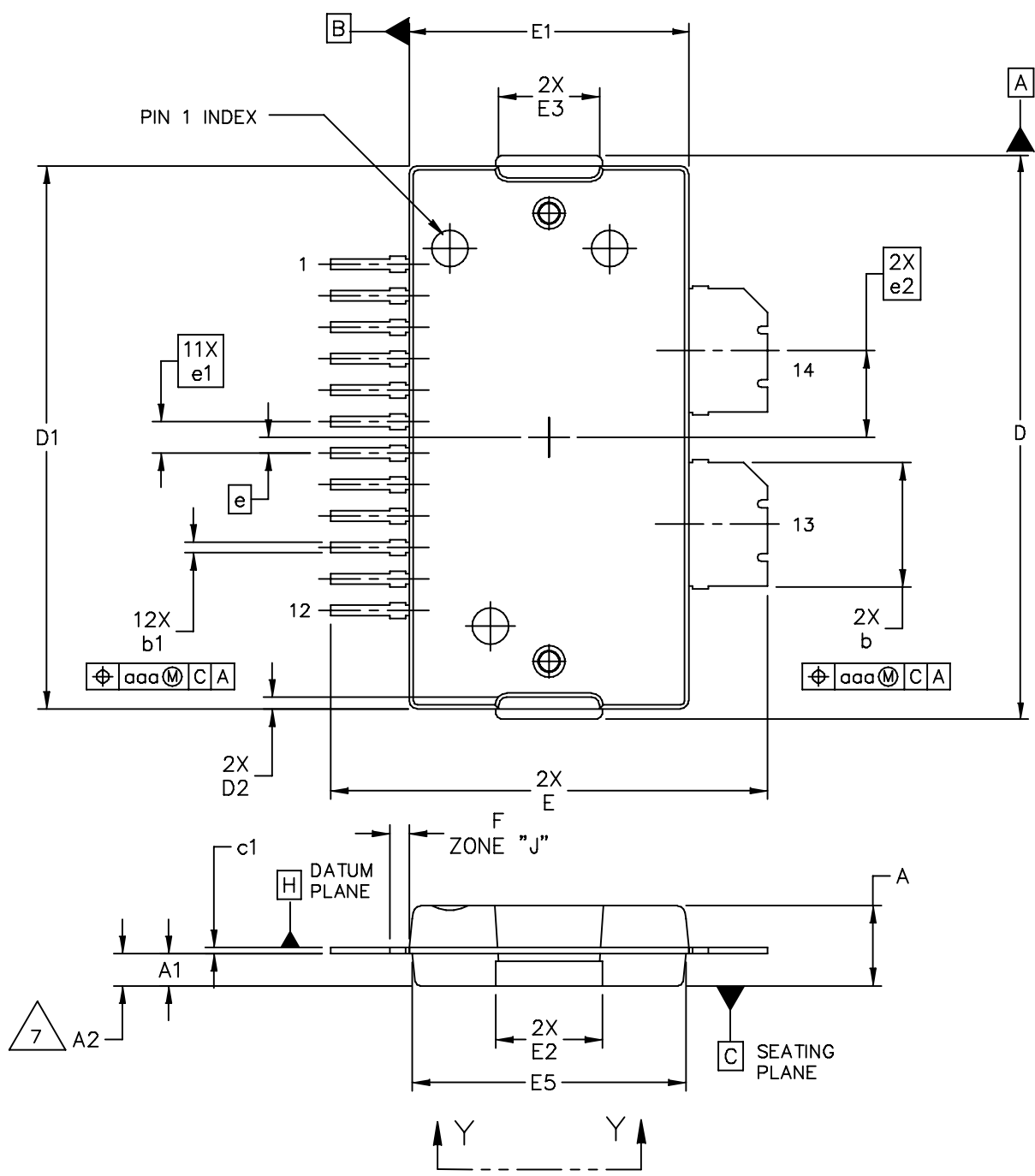
NOTES:

1. CONTROLLING DIMENSION: INCH
2. INTERPRET DIMENSIONS AND TOLERANCES PER ASME Y14.5M-1994.
3. DATUM PLANE -H- IS LOCATED AT THE TOP OF LEAD AND IS COINCIDENT WITH THE LEAD WHERE THE LEAD EXITS THE PLASTIC BODY AT THE TOP OF THE PARTING LINE.
4. DIMENSIONS "D" AND "E1" DO NOT INCLUDE MOLD PROTRUSION. ALLOWABLE PROTRUSION IS .006 (0.15) PER SIDE. DIMENSIONS "D" AND "E1" DO INCLUDE MOLD MISMATCH AND ARE DETERMINED AT DATUM PLANE -H-.
5. DIMENSIONS "b" AND "b1" DO NOT INCLUDE DAMBAR PROTRUSION. ALLOWABLE DAMBAR PROTRUSION SHALL BE .005 (0.13) TOTAL IN EXCESS OF THE "b" AND "b1" DIMENSIONS AT MAXIMUM MATERIAL CONDITION.
6. HATCHING REPRESENTS THE EXPOSED AREA OF THE HEAT SLUG.
7. DIM A2 APPLIES WITHIN ZONE "J" ONLY.

ARCHIVE INFORMATION

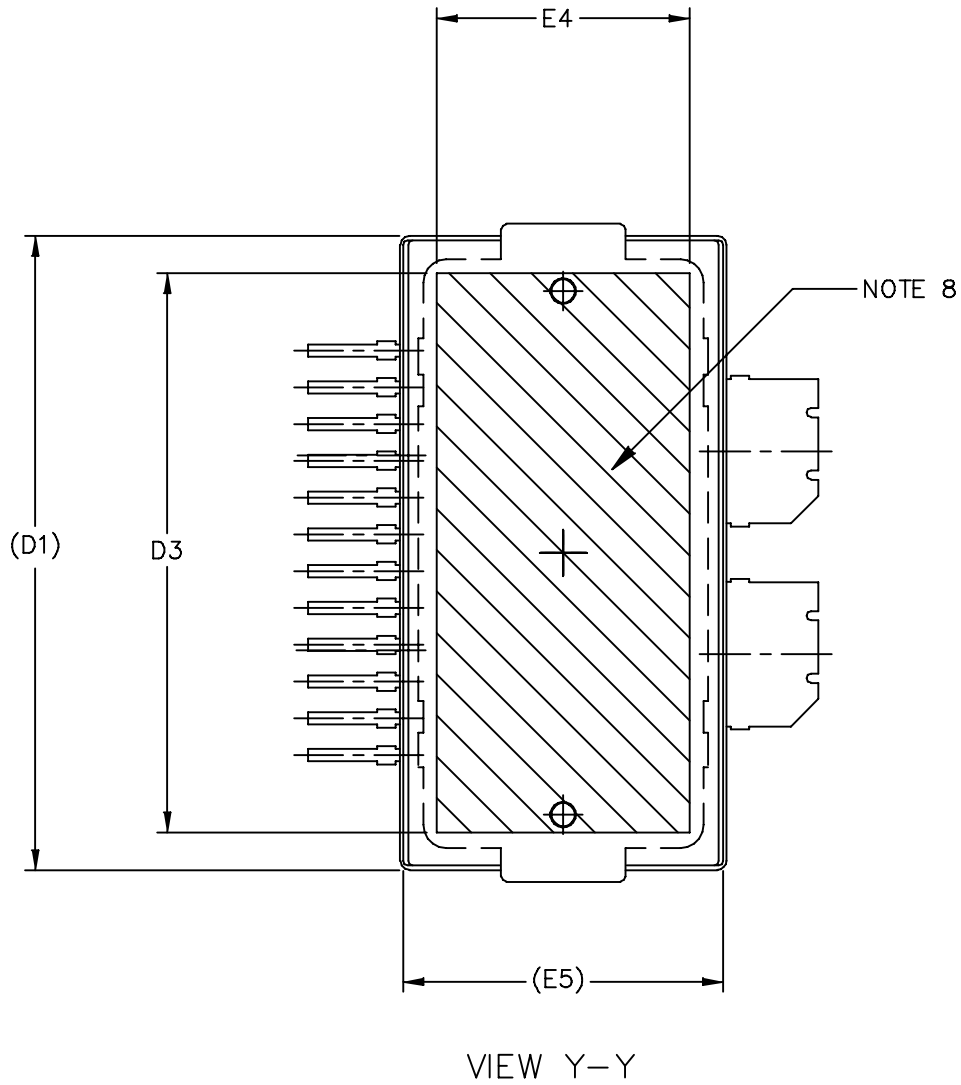
ARCHIVE INFORMATION

DIM	INCH		MILLIMETER		DIM	INCH		MILLIMETER	
	MIN	MAX	MIN	MAX		MIN	MAX	MIN	MAX
A	.100	.104	2.54	2.64	b	.154	.160	3.91	4.06
A1	.039	.043	0.99	1.09	b1	.010	.016	0.25	0.41
A2	.040	.042	1.02	1.07	c1	.007	.011	0.18	0.28
D	.928	.932	23.57	23.67	e	.020 BSC		0.51 BSC	
D1	.810 BSC		20.57 BSC		e1	.040 BSC		1.02 BSC	
E	.551	.559	14.00	14.20	e2	.1105 BSC		2.807 BSC	
E1	.353	.357	8.97	9.07	r1	.063	.068	1.6	1.73
E2	.346	.350	8.79	8.89					
F	.025 BSC		0.64 BSC		aaa	.004		0.10	
M	.600	----	15.24	----					
N	.270	----	6.86	----					
© FREESCALE SEMICONDUCTOR, INC. ALL RIGHTS RESERVED.			MECHANICAL OUTLINE			PRINT VERSION NOT TO SCALE			
TITLE:  TO-272 WIDE BODY 14 LEAD					DOCUMENT NO: 98ASA10649D			REV: A	
					CASE NUMBER: 1617-02			27 JUN 2007	
					STANDARD: NON-JEDEC				



© FREESCALE SEMICONDUCTOR, INC. ALL RIGHTS RESERVED.		MECHANICAL OUTLINE		PRINT VERSION NOT TO SCALE	
TITLE: TO-270 WIDE BODY 14 LEAD		DOCUMENT NO: 98ASA10650D		REV: A	
		CASE NUMBER: 1618-02		19 JUN 2007	
		STANDARD: NON-JEDEC			





© FREESCALE SEMICONDUCTOR, INC. ALL RIGHTS RESERVED.	MECHANICAL OUTLINE	PRINT VERSION NOT TO SCALE	
TITLE: TO-270 WIDE BODY 14 LEAD	DOCUMENT NO: 98ASA10650D	REV: A	
	CASE NUMBER: 1618-02	19 JUN 2007	
	STANDARD: NON-JEDEC		

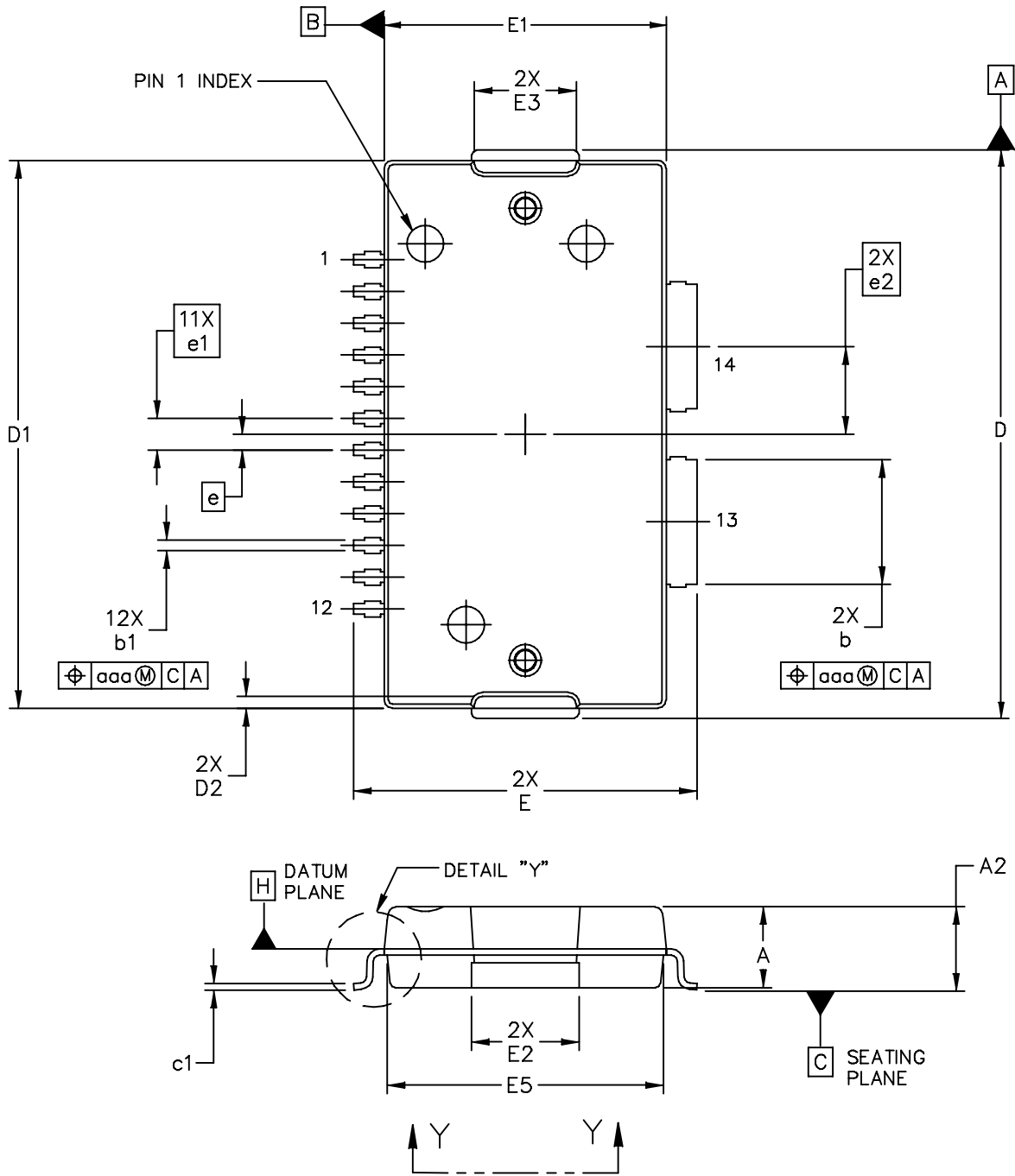
NOTES:

1. CONTROLLING DIMENSION: INCH
2. INTERPRET DIMENSIONS AND TOLERANCES PER ASME Y14.5M-1994.
3. DATUM PLANE -H- IS LOCATED AT THE TOP OF LEAD AND IS COINCIDENT WITH THE LEAD WHERE THE LEAD EXITS THE PLASTIC BODY AT THE TOP OF THE PARTING LINE.
4. DIMENSIONS "D" AND "E1" DO NOT INCLUDE MOLD PROTRUSION. ALLOWABLE PROTRUSION IS .006 PER SIDE. DIMENSIONS "D" AND "E1" DO INCLUDE MOLD MISMATCH AND ARE DETERMINED AT DATUM PLANE -H-.
5. DIMENSIONS "b" AND "b1" DOES NOT INCLUDE DAMBAR PROTRUSION. ALLOWABLE DAMBAR PROTRUSION SHALL BE .005 TOTAL IN EXCESS OF THE "b" AND "b1" DIMENSION AT MAXIMUM MATERIAL CONDITION.
6. DATUMS -A- AND -B- TO BE DETERMINED AT DATUM PLANE -H-.
7. DIMENSION A2 APPLIES WITHIN ZONE "J" ONLY.
8. HATCHING REPRESENTS THE EXPOSED AREA OF THE HEAT SLUG.

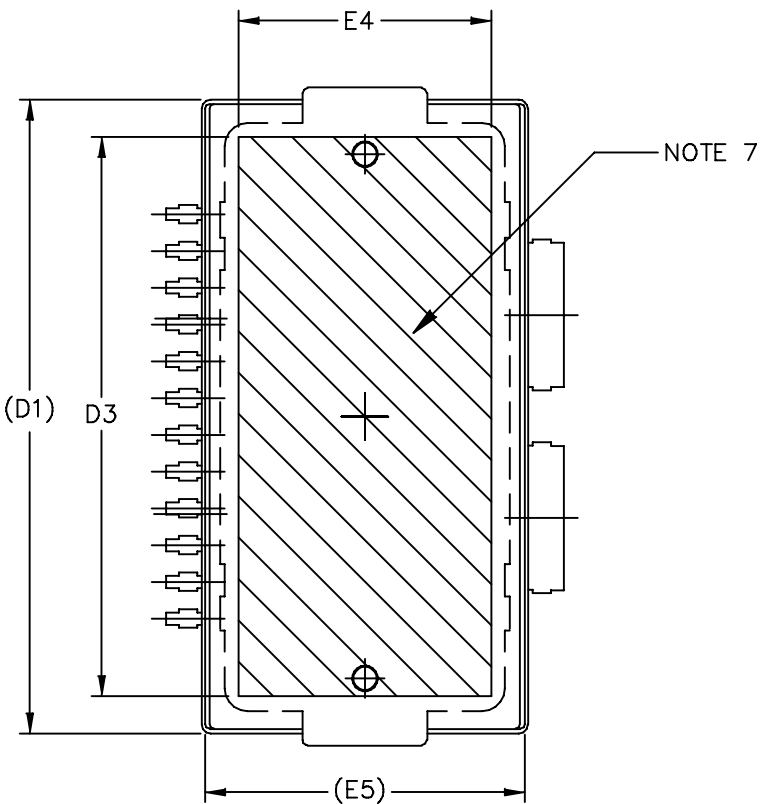
ARCHIVE INFORMATION

ARCHIVE INFORMATION

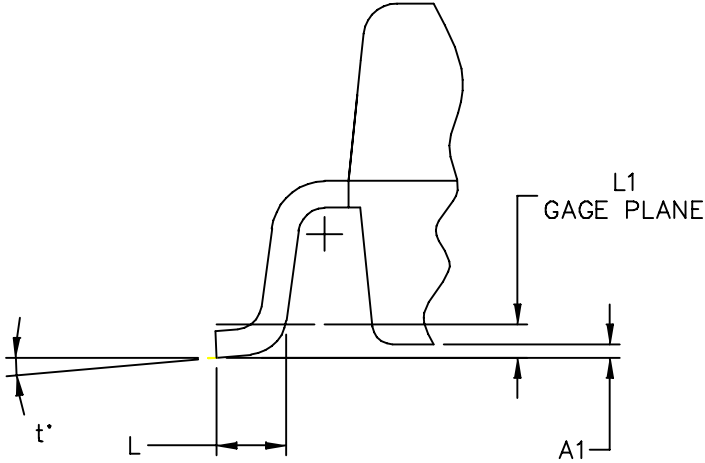
DIM	INCH		MILLIMETER		DIM	INCH		MILLIMETER	
	MIN	MAX	MIN	MAX		MIN	MAX	MIN	MAX
A	.100	.104	2.54	2.64	F	.025 BSC		0.64 BSC	
A1	.039	.043	0.99	1.09	b	.154	.160	3.91	4.06
A2	.040	.042	1.02	1.07	b1	.010	.016	0.25	0.41
D	.712	.720	18.08	18.29	c1	.007	.011	.18	.28
D1	.688	.692	17.48	17.58	e	.020 BSC		0.51 BSC	
D2	.011	.019	0.28	0.48	e1	.040 BSC		1.02 BSC	
D3	.600	---	15.24	---	e2	.1105 BSC		2.807 BSC	
E	.551	.559	14	14.2					
E1	.353	.357	8.97	9.07	aaa	.004		.10	
E2	.132	.140	3.35	3.56					
E3	.124	.132	3.15	3.35					
E4	.270	---	6.86	---					
E5	.346	.350	8.79	8.89					
© FREESCALE SEMICONDUCTOR, INC. ALL RIGHTS RESERVED.			MECHANICAL OUTLINE			PRINT VERSION NOT TO SCALE			
TITLE: TO-270 WIDE BODY 14 LEAD					DOCUMENT NO: 98ASA10650D			REV: A	
					CASE NUMBER: 1618-02			19 JUN 2007	
					STANDARD: NON-JEDEC				



© FREESCALE SEMICONDUCTOR, INC. ALL RIGHTS RESERVED.	MECHANICAL OUTLINE	PRINT VERSION NOT TO SCALE	
TITLE: TO-270 WIDE BODY 14 LEAD GULL WING	DOCUMENT NO: 98ASA10653D	REV: A	
	CASE NUMBER: 1621-02	19 JUN 2007	
	STANDARD: NON-JEDEC		



VIEW Y-Y



DETAIL "Y"

ARCHIVE INFORMATION

ARCHIVE INFORMATION

© FREESCALE SEMICONDUCTOR, INC. ALL RIGHTS RESERVED.		MECHANICAL OUTLINE	PRINT VERSION NOT TO SCALE
TITLE: TO-270 WIDE BODY 14 LEAD GULL WING	DOCUMENT NO: 98ASA10653D		REV: A
	CASE NUMBER: 1621-02		19 JUN 2007
	STANDARD: NON-JEDEC		

NOTES:

1. CONTROLLING DIMENSION: INCH
2. INTERPRET DIMENSIONS AND TOLERANCES PER ASME Y14.5M-1994.
3. DATUM PLANE -H- IS LOCATED AT THE TOP OF LEAD AND IS COINCIDENT WITH THE LEAD WHERE THE LEAD EXITS THE PLASTIC BODY AT THE TOP OF THE PARTING LINE.
4. DIMENSIONS "D" AND "E1" DO NOT INCLUDE MOLD PROTRUSION. ALLOWABLE PROTRUSION IS .006 PER SIDE. DIMENSIONS "D" AND "E1" DO INCLUDE MOLD MISMATCH AND ARE DETERMINED AT DATUM PLANE -H-.
5. DIMENSIONS "b" AND "b1" DOES NOT INCLUDE DAMBAR PROTRUSION. ALLOWABLE DAMBAR PROTRUSION SHALL BE .005 TOTAL IN EXCESS OF THE "b" AND "b1" DIMENSION AT MAXIMUM MATERIAL CONDITION.
6. DATUMS -A- AND -B- TO BE DETERMINED AT DATUM PLANE -H-.
7. HATCHING REPRESENTS THE EXPOSED AREA OF THE HEAT SLUG.

ARCHIVE INFORMATION

ARCHIVE INFORMATION

DIM	INCH		MILLIMETER		DIM	INCH		MILLIMETER	
	MIN	MAX	MIN	MAX		MIN	MAX	MIN	MAX
A	.100	.104	2.54	2.64	L	.018	.024	0.46	0.61
A1	.001	.004	0.02	0.10	L1	.010 BSC		0.25 BSC	
A2	.099	.110	2.51	2.79	b	.154	.160	3.91	4.06
D	.712	.720	18.08	18.29	b1	.010	.016	0.25	0.41
D1	.688	.692	17.48	17.58	c1	.007	.011	.18	.28
D2	.011	.019	0.28	0.48	e	.020 BSC		0.51 BSC	
D3	.600	---	15.24	---	e1	.040 BSC		1.02 BSC	
E	.429	.437	10.9	11.1	e2	.1105 BSC		2.807 BSC	
E1	.353	.357	8.97	9.07	t	2°	8°	2°	8°
E2	.132	.140	3.35	3.56					
E3	.124	.132	3.15	3.35	aaa	.004		.10	
E4	.270	---	6.86	---					
E5	.346	.350	8.79	8.89					

© FREESCALE SEMICONDUCTOR, INC. ALL RIGHTS RESERVED.		MECHANICAL OUTLINE		PRINT VERSION NOT TO SCALE	
TITLE: TO-270 WIDE BODY 14 LEAD GULL WING			DOCUMENT NO: 98ASA10653D		REV: A
			CASE NUMBER: 1621-02		19 JUN 2007
			STANDARD: NON-JEDEC		

## PRODUCT DOCUMENTATION

Refer to the following documents to aid your design process.

### Application Notes

- AN1907: Solder Reflow Attach Method for High Power RF Devices in Plastic Packages
- AN1955: Thermal Measurement Methodology of RF Power Amplifiers
- AN1987: Quiescent Current Control for the RF Integrated Circuit Device Family
- AN3263: Bolt Down Mounting Method for High Power RF Transistors and RFICs in Over-Molded Plastic Packages

### Engineering Bulletins

- EB212: Using Data Sheet Impedances for RF LDMOS Devices

## REVISION HISTORY

The following table summarizes revisions to this document.

Revision	Date	Description
0	Feb. 2007	<ul style="list-style-type: none"> <li>• Initial Release of Data Sheet</li> </ul>
1	May 2007	<ul style="list-style-type: none"> <li>• Changed Device box to 960 MHz to reflect functional test frequency, p. 1</li> <li>• Added Power Added Efficiency to GSM EDGE Application Typical Performances, p. 1</li> <li>• Changed "5:1 VSWR, @ 28 Vdc" to "10:1 VSWR, @ 32 Vdc" in the Capable of Handling bullet, p. 1</li> <li>• Added Footnote (1) to Quiescent Current Thermal Tracking bullet under Features section and to Quiescent Current Temperature Compensation in Fig. 1, Functional Block Diagram, p. 1</li> <li>• Added top-level, 2-stage block diagram depiction to Fig. 2, Pin Connections; updated Note, p. 1</li> <li>• Added Case Operating Temperature limit to the Maximum Ratings table and set limit to 150°C, p. 2</li> <li>• Added Stage 1 and Stage 2 DC Electrical Characteristics tables, p. 2, 3</li> <li>• In Table 6, Component Designations and Values, corrected Part Number ATC100B331JT500XT to ATC100B331JT200XT for C24 capacitor, p. 4</li> <li>• Updated Figs. 7 and 8, Power Gain versus Output Power, to remove non-variable <math>I_{DQ}</math> value, p. 6</li> <li>• Updated Fig. 9, Intermodulation Distortion Products versus Output Power, to show PEP and not CW; corrected frequency value to show 100 kHz Tone Spacing, p. 7</li> <li>• Updated graphical representation of Ideal/Actual in Fig. 11, Pulsed CW Output Power versus Input Power, to show correct 3 and 6 dB compression points, p. 7</li> </ul>
2	June 2007	<ul style="list-style-type: none"> <li>• Removed Case Operating Temperature from Maximum Ratings table, p. 2. Case Operating Temperature rating will be added to the Maximum Ratings table when parts' Operating Junction Temperature is increased to 225°C.</li> </ul>
3	Dec. 2008	<ul style="list-style-type: none"> <li>• Changed full frequency band in Typical GSM Performance bullet to <math>f = 960</math> MHz to match actual production test, p. 1</li> <li>• Changed Storage Temperature Range in Max Ratings table from -65 to +200 to -65 to +150 for standardization across products, p. 2</li> <li>• Added Case Operating Temperature limit to the Maximum Ratings table and set limit to 150°C, p. 2</li> <li>• Operating Junction Temperature increased from 200°C to 225°C in Maximum Ratings table, related "Continuous use at maximum temperature will affect MTTF" footnote added and changed 200°C to 225°C in Capable Plastic Package bullet, p. 1, 2</li> <li>• Corrected Z10 from 1.17" to 0.117" in the Test Circuit Schematic Z list, p. 4</li> <li>• Updated Part Numbers in Table 6, Component Designations and Values, to latest RoHS compliant part numbers, p. 4</li> <li>• Replaced Case Outline 1617-01 with 1617-02, Issue A, p. 1, 13-15. Revised cross-hatched area for exposed heat spreader. Added pin numbers 1, 12, 13, and 14 to Sheets 1 and 2. Corrected mm Min and Max values for dimension A1 to 0.99 and 1.09, respectively.</li> <li>• Replaced Case Outline 1618-01 with 1618-02, Issue A, p. 1, 16-18. Added pin numbers 1, 12, 13, and 14 and Pin 1 Index designation to Sheet 1. Corrected dimensions e and e1 on Sheet 1. Removed Pin 5 designation from Sheet 2.</li> <li>• Replaced Case Outline 1621-01 with 1621-02, Issue A, p. 1, 19-21. Added pin numbers 1, 12, 13, and 14 and Pin 1 Index designation to Sheet 1. Corrected dimensions e and e1 on Sheets 1 and 3. Removed Pin 5 designation from Sheet 2.</li> <li>• Added Product Documentation and Revision History, p. 22</li> </ul>

ARCHIVE INFORMATION

ARCHIVE INFORMATION

**How to Reach Us:**

**Home Page:**

[www.freescale.com](http://www.freescale.com)

**Web Support:**

<http://www.freescale.com/support>

**USA/Europe or Locations Not Listed:**

Freescale Semiconductor, Inc.  
 Technical Information Center, EL516  
 2100 East Elliot Road  
 Tempe, Arizona 85284  
 1-800-521-6274 or +1-480-768-2130  
[www.freescale.com/support](http://www.freescale.com/support)

**Europe, Middle East, and Africa:**

Freescale Halbleiter Deutschland GmbH  
 Technical Information Center  
 Schatzbogen 7  
 81829 Muenchen, Germany  
 +44 1296 380 456 (English)  
 +46 8 52200080 (English)  
 +49 89 92103 559 (German)  
 +33 1 69 35 48 48 (French)  
[www.freescale.com/support](http://www.freescale.com/support)

**Japan:**

Freescale Semiconductor Japan Ltd.  
 Headquarters  
 ARCO Tower 15F  
 1-8-1, Shimo-Meguro, Meguro-ku,  
 Tokyo 153-0064  
 Japan  
 0120 191014 or +81 3 5437 9125  
[support.japan@freescale.com](mailto:support.japan@freescale.com)

**Asia/Pacific:**

Freescale Semiconductor China Ltd.  
 Exchange Building 23F  
 No. 118 Jianguo Road  
 Chaoyang District  
 Beijing 100022  
 China  
 +86 10 5879 8000  
[support.asia@freescale.com](mailto:support.asia@freescale.com)

**For Literature Requests Only:**

Freescale Semiconductor Literature Distribution Center  
 P.O. Box 5405  
 Denver, Colorado 80217  
 1-800-441-2447 or +1-303-675-2140  
 Fax: +1-303-675-2150  
[LDCForFreescaleSemiconductor@hibbertgroup.com](mailto:LDCForFreescaleSemiconductor@hibbertgroup.com)

Information in this document is provided solely to enable system and software implementers to use Freescale Semiconductor products. There are no express or implied copyright licenses granted hereunder to design or fabricate any integrated circuits or integrated circuits based on the information in this document.

Freescale Semiconductor reserves the right to make changes without further notice to any products herein. Freescale Semiconductor makes no warranty, representation or guarantee regarding the suitability of its products for any particular purpose, nor does Freescale Semiconductor assume any liability arising out of the application or use of any product or circuit, and specifically disclaims any and all liability, including without limitation consequential or incidental damages. "Typical" parameters that may be provided in Freescale Semiconductor data sheets and/or specifications can and do vary in different applications and actual performance may vary over time. All operating parameters, including "Typicals", must be validated for each customer application by customer's technical experts. Freescale Semiconductor does not convey any license under its patent rights nor the rights of others. Freescale Semiconductor products are not designed, intended, or authorized for use as components in systems intended for surgical implant into the body, or other applications intended to support or sustain life, or for any other application in which the failure of the Freescale Semiconductor product could create a situation where personal injury or death may occur. Should Buyer purchase or use Freescale Semiconductor products for any such unintended or unauthorized application, Buyer shall indemnify and hold Freescale Semiconductor and its officers, employees, subsidiaries, affiliates, and distributors harmless against all claims, costs, damages, and expenses, and reasonable attorney fees arising out of, directly or indirectly, any claim of personal injury or death associated with such unintended or unauthorized use, even if such claim alleges that Freescale Semiconductor was negligent regarding the design or manufacture of the part.

Freescale™ and the Freescale logo are trademarks of Freescale Semiconductor, Inc. All other product or service names are the property of their respective owners.

© Freescale Semiconductor, Inc. 2007-2008. All rights reserved.