



SERIES: EP5A 20W | **DESCRIPTION:** AC-DC POWER SUPPLY

FEATURES

- 20 W power
- universal input (90~264 Vac)
- single regulated 5 V output
- over voltage, over current, and short circuit protections
- UL/cUL safety approvals
- level V efficiency
- custom designs available



MODEL	output voltage (Vdc)	output current max (A)	output power max (W)	ripple and noise ¹ max (mVp-p)	efficiency level
EP5A050400U	5	4	20	50	V

Notes: 1. At full load, ≥100 Vac input, 20 MHz bandwidth oscilloscope, each output terminated with 10 μF aluminum electrolytic and 0.1 μF ceramic capacitors.

PART NUMBER KEY

EP5A050400U - XX - EJ - CXX

Base Number
example of 5 Vdc, 4 A

DC Plug Type

Factory Designation

Reserved for Custom Configurations

INPUT

parameter	conditions/description	min	typ	max	units
voltage		90		264	Vac
frequency		47		63	Hz
current	at full load			0.5	A
inrush current	at 115 Vac, full load, 25°C, cold start			30	A
leakage current				0.25	mA
input fuse	2A/250V				

OUTPUT

parameter	conditions/description	min	typ	max	units
line regulation			±5		%
load regulation	from +20% to +80% load		±10		%
start-up				2	s
hold-up	at 110 Vac, 50 Hz, 80% max. load	10			ms

PROTECTIONS

parameter	conditions/description	min	typ	max	units
over voltage protection	output shut down				
over current protection	automatic power decrease, auto recovery			200	%
short circuit protection	output terminal protected				

SAFETY & COMPLIANCE

parameter	conditions/description	min	typ	max	units
isolation voltage	input to output at 10 mA for 2 seconds	3,000			Vac
isolation resistance	input to output at 500 Vdc	10			MΩ
safety approvals	UL/cUL, LPS				
EMI/EMC	FCC Part 15B Class B				
MTBF	as per Telcordia SR-332, Issue 2 at full load, 25°C	300,000			hrs
RoHS compliant	yes				

ENVIRONMENTAL

parameter	conditions/description	min	typ	max	units
operating temperature		0		40	°C
storage temperature		-25		85	°C
operating humidity		10		95	%
storage humidity		10		95	%

MECHANICAL

parameter	conditions/description	min	typ	max	units
dimensions	75 x 35 x 62				mm
input plug	fixed US				

MECHANICAL DRAWING

units: mm
tolerance: ±1

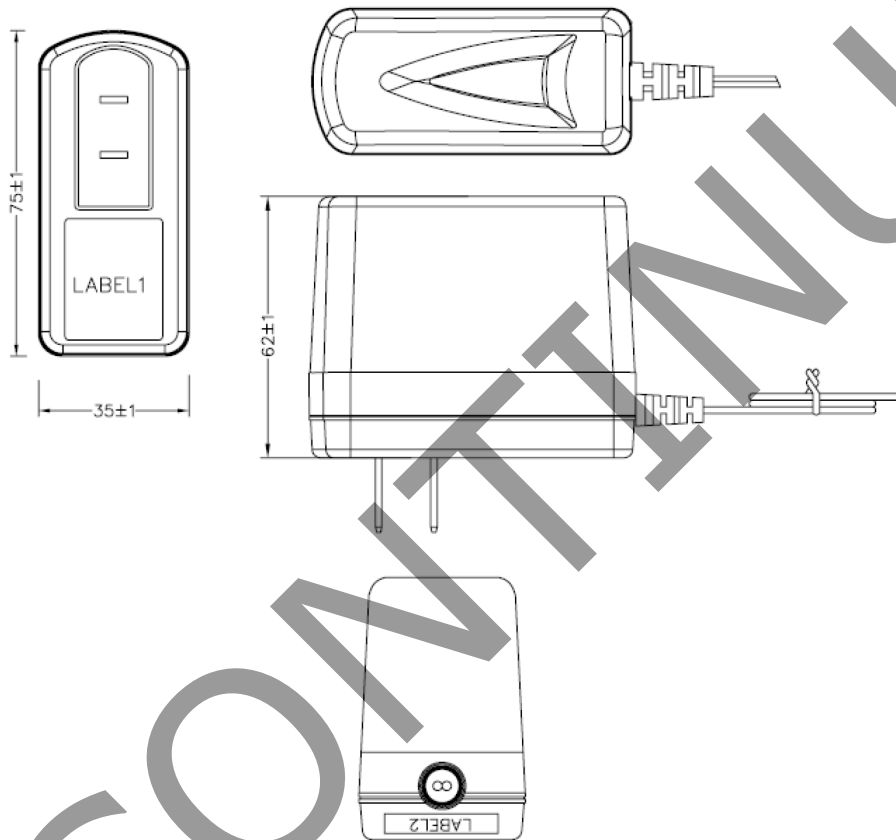

DC CORD

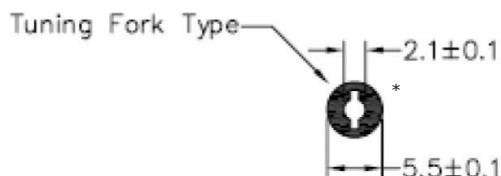
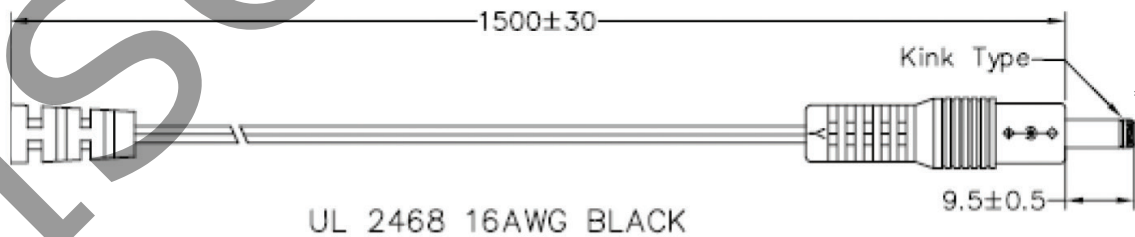

MODEL NO.	CABLE GAUGE	CORD LENGTH
EPSA050400U	16 AWG	1,500 mm ±30

*Standard "P5P" plug shown

OUTPUT PLUG OPTIONS

3.5 mm Phono Plug

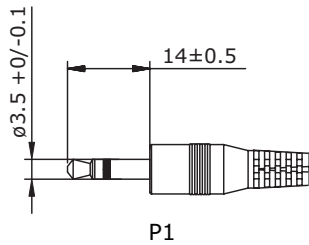

P1

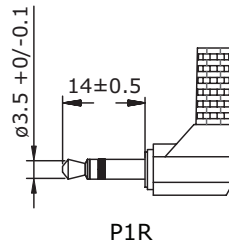

P1R

*Tip positive

Standard DC Plug

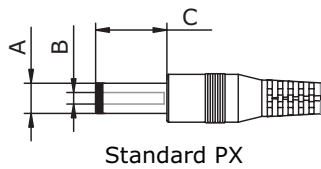

Standard PX

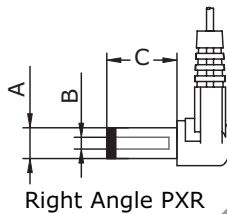

Right Angle PXR

	A	B	C	Unit
P5/P5R	5.5	2.1	9.5	mm
P6/P6R	5.5	2.5	9.5	mm
P7/P7R	3.5	1.35	9.5	mm
P8/P8R	3.8	1.35	9.5	mm
P9/P9R	3.8	1.05	9.5	mm

Locking DC Plug

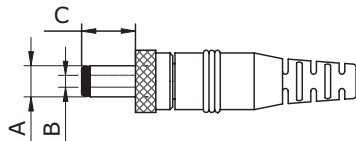

	A	B	C	Unit
P10	5.5	2.1	9.5	mm
P11	5.5	2.5	9.5	mm

EIAJ Plugs

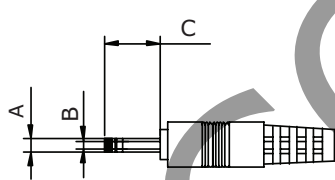

Standard PXX

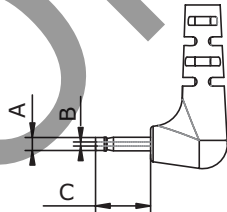

Right Angle PXXR

	EIAJ	A	B	C	D	Unit
P12/P12R	EIAJ-1	2.35	0.7	9.5	NA	mm
P13/P13R	EIAJ-2	4.0	1.7	9.5	5.0	mm
P14/P14R	EIAJ-3	4.75	1.7	9.5	5.0	mm

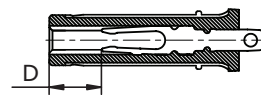

Stripped and Tinned

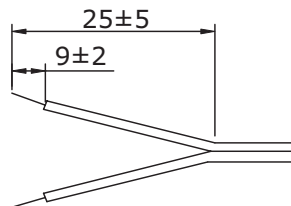

DC PLUG TYPE

ST
Stripped and Tinned

PXXXX

Plug Type Plug Angle:
"Blank" = Standard
R = Right Angle Plug Polarity:
"Blank" = N/A
P = Center Positive \ominus \oplus
N = Center Negative \oplus \ominus

*Contact CUI for additional output plug options.

REVISION HISTORY

rev.	description	date
1.0	initial release	06/14/2013

The revision history provided is for informational purposes only and is believed to be accurate.



CUI INC[®]

Headquarters
20050 SW 112th Ave.
Tualatin, OR 97062
800.275.4899

Fax 503.612.2383
cui.com
techsupport@cui.com

This device complies with part 15 of the FCC Rules. Operation is subject to the following two conditions:

- (1) This device may not cause harmful interference, and
- (2) this device must accept any interference received, including interference that may cause undesired operation.

CUI offers a one (1) year limited warranty. Complete warranty information is listed on our website.

CUI reserves the right to make changes to the product at any time without notice. Information provided by CUI is believed to be accurate and reliable. However, no responsibility is assumed by CUI for its use, nor for any infringements of patents or other rights of third parties which may result from its use.

CUI products are not authorized or warranted for use as critical components in equipment that requires an extremely high level of reliability. A critical component is any component of a life support device or system whose failure to perform can be reasonably expected to cause the failure of the life support device or system, or to affect its safety or effectiveness.