

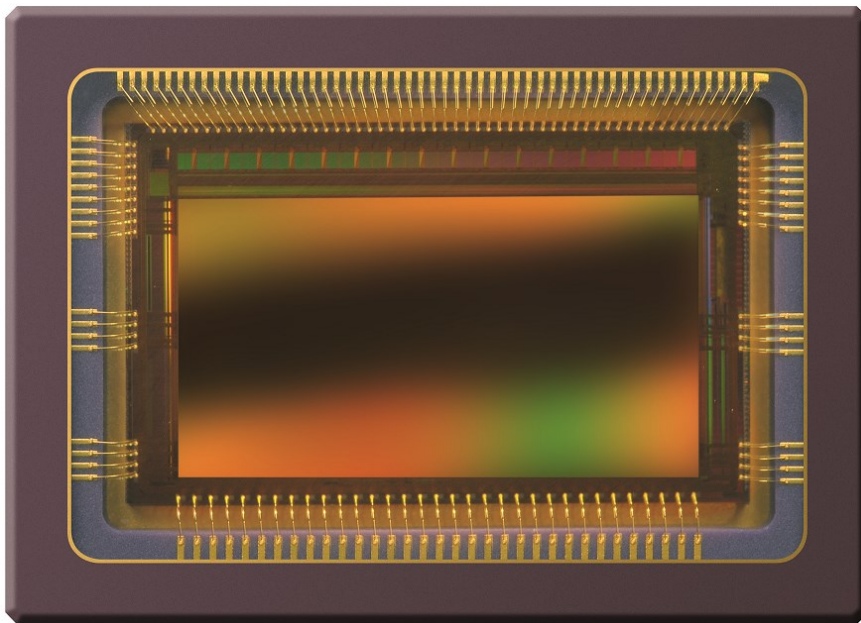

## 2.2 Megapixel machine vision CMOS image sensor



# Datasheet

## Change record

Issue	Date	Modification
1	06/05/2009	Origination
1.1	12/11/2009	- Corrected register address of sub_s[7:0] to '35' (p 29/30/33)
1.2	11/01/2010	Adjusted min input frequency (chapter 3.5)
1.3	14/01/2010	Adjusted pin width in package drawing
2.7	29/03/2010	Added spectral response Added spectral response for color devices Updated specifications for version 2 devices Changed VDD18 to VDD20 Added ordering info Added handling and soldering procedures Removed "confidential" from footer Added recommended and adjustable register settings
2.1	22/7/2010	Frame rate calculation included
2.2	2/8/2010	Read-out in 12 bit mode added
2.3	1/9/2010	Added exposure time offset ((0.65 x register73 x clk_per x 129)
2.4	17/9/2010	Added Vtf_11 to GND remark
2.5	19/10/2010	Added E12 spectral response curve and part numbers
2.6	11/1/2011	Added RGB Bayer pattern details
2.7	1/2/2011	Added electrical IO specifications
2.8	25/3/2011	Updated reflow soldering profile
2.9	13/4/2011	Changed tilt to 0.2 degrees, updated spectral response, changed exposure time formula
2.9.1	20/5/2011	Changed 12 bit read-out mode (removed 16 and 8 outputs)
2.9.2	17/11/2011	Add frame rate calculation and examples
2.9.3	24/02/2012	Added: <ul style="list-style-type: none"> <li>- Temperature sensor details</li> <li>- Image flipping details</li> <li>- Power consumption details</li> <li>- Gain details</li> <li>- LCC package</li> </ul> Full revision
2.9.4	23/03/2012	Added: <ul style="list-style-type: none"> <li>- Input clocks phase</li> <li>- LVDS termination</li> <li>- LVDS TIA/EIA-644A standard</li> <li>- Details on frame rate in external mode</li> <li>- Use of register 125</li> <li>- Minimum length of SYS_RES_N and FRAME_REQ</li> <li>- Dark current doubling rate</li> <li>- Offset details</li> <li>- LCC pinout list</li> <li>- Pin layout</li> </ul> Changed FOT_REG_VALUE to reg73 Layout changes

Issue	Date	Modification
2.9.5	24/05/2012	Added: <ul style="list-style-type: none"> <li>- Self-heating</li> <li>- Supply peaks and decoupling</li> <li>- I/O capacitance</li> <li>- Power supplies startup sequence</li> <li>- Overview outputs vs. channel mapping</li> <li>- Actual gain vs. register setting for multiple clock speeds</li> <li>- Typical response curve</li> </ul> Updated package drawing PGA dim. 8.889 to 0.889
2.9.6	30/07/2012	Added: <ul style="list-style-type: none"> <li>- PLR Vlow2/3 enable bit</li> <li>- Sampling of digital inputs on rising CLK_IN</li> <li>- Details on LVDS data out in multiplex modes</li> <li>- CTR channel bits on TDIG1 and TDIG2 pins</li> <li>- Evaluation kit available</li> <li>- Minimum time between Frame_ req pulses in internal mode</li> <li>- Temperature sensor calibration example</li> </ul> Updated: <ul style="list-style-type: none"> <li>- Bayer pattern figure (pixel(0,0) green → red). No actual device change compared to previous devices.</li> <li>- Supply noise influence</li> <li>- Control bit INTE1/2 (no FOT overlap)</li> <li>- FOT and Read-out time rounding</li> <li>- Detailed timing of control channel figure</li> <li>- LVDS clock delay figure (CLK_IN period)</li> <li>- SPI timing from SPI upload to FRAME_REQ (1μs → 1ms)</li> </ul> Removed: <ul style="list-style-type: none"> <li>- Reference errors</li> </ul>
2.9.7	01/08/2013	Added: <ul style="list-style-type: none"> <li>- Pin head dimensions to package drawing</li> <li>- TDIG1 and TDIG2 addresses to register overview</li> <li>- Recommended FOT register settings to register overview</li> <li>- Angular response curve</li> <li>- Minimum exposure value</li> </ul> Updated: <ul style="list-style-type: none"> <li>- Training pattern of control channel</li> <li>- Text and figure in Image flipping chapter</li> <li>- Text and figure in Color Filter chapter</li> <li>- Assembly drawing: now refers to pixel(0,0), added dimensions, transparent view, pin numbers and corrected tile of die</li> <li>- Supply settings table: peak current calculation, typical values to recommended values, supply voltage range</li> <li>- Connection diagram: changed 1.8V to 2.1V</li> <li>- Response curve: replaced figure</li> <li>- Temperature sensor figure now refers to pixel (0,0)</li> <li>- Start-up sequence: time after SPI upload described more accurately</li> <li>- LVDS driver specification: Voc dependency</li> </ul>

Issue	Date	Modification
2.10	04/12/2013	Added: <ul style="list-style-type: none"> <li>- Skew limits for LVDS clock</li> </ul> Updated: <ul style="list-style-type: none"> <li>- Added settling time to reset sequence figure</li> <li>- Corrected some spelling mistakes</li> <li>- Some layout improvements</li> <li>- Assembly drawing: corrected pixel(0,0) location</li> <li>- Mechanical drawing: now has correct dimensions for cavity, and higher resolution</li> <li>- Recommended register settings table is now sorted on register address.</li> <li>- Corrected aspect ratio for figure 29</li> <li>- Temperature sensor location figure is updated</li> </ul>
2.11	20/03/2014	Added: <ul style="list-style-type: none"> <li>- The FOT register can be lowered to 5, when required for very short integration times</li> <li>- The pin list description now lists what pins are optional</li> <li>- Recommendation for unused pin in pinning chapter</li> <li>- Description for i_lvds register. Lowering this can be useful for meeting EMC standards</li> <li>- All necessary register names are now in the register overview</li> <li>- All register addresses in Chapter 5 now include bit numbers</li> <li>- Part numbers for all package types are now included in the Ordering Information table</li> </ul> Updated: <ul style="list-style-type: none"> <li>- Register overview: some new descriptions and references</li> <li>- New figures for transmittance and QE are easier to read</li> <li>- “color” register is now named “mono”, to better fit the description</li> <li>- Pin list table is now sorted on function rather than pin number</li> <li>- Specification overview in Chapter 1.3 is now clearer</li> <li>- Description for optimizing register settings is now more complete</li> <li>- Description for start-up and reset sequence</li> <li>- Vtglow2 and Vtglow3 registers are 6 bits long, instead of 7</li> <li>- Description for settling time should be clearer now</li> <li>- LCC package was listed as 95 pins in the spec overview, should be 92 pins</li> </ul> Removed: <ul style="list-style-type: none"> <li>- Pixel coordinates on block diagram are removed as they were causing confusion</li> </ul>
2.12	28/01/2015	Updated: <ul style="list-style-type: none"> <li>- The power figure in the Specification Overview is now more accurate; it considers the sensor configuration</li> <li>- The exposure time is shortest in external exposure mode, so this mode is added to the calculation.</li> <li>- FRAME_REQ is level sensitive, not edge sensitive</li> <li>- Maximum number of frames is 65535, not 65548</li> <li>- Corrected note that said that the exposure starts directly after F_REQ, there is a delay between the two</li> <li>- Corrected calibration procedure, step 2 should be repeated, not step 1.</li> </ul> Removed: <ul style="list-style-type: none"> <li>- Nr_slopes2 register from overview, this is an unused register.</li> <li>- Scratch/dig/bubble spec for cover glass</li> </ul>

Issue	Date	Modification
2.13	18/06/2015	Updated: <ul style="list-style-type: none"><li>- LCC pin layout now correctly says it's the bottom view, not the top</li><li>- LCC Product number now for AR coated glass only</li></ul> Added <ul style="list-style-type: none"><li>- Transmittance curve for AR coated glass</li></ul>

### Disclaimer

CMOSIS reserves the right to change the product, specification and other information contained in this document without notice. Although CMOSIS does its best efforts to provide correct information, this is not warranted.

## Table of Contents

<b>1</b>	<b>Introduction .....</b>	<b>9</b>
1.1	Overview .....	9
1.2	Features .....	9
1.3	Specifications .....	9
1.4	Connection diagram .....	10
<b>2</b>	<b>Sensor architecture .....</b>	<b>11</b>
2.1	Pixel array.....	11
2.2	Analog front end.....	12
2.3	LVDS block.....	12
2.4	Sequencer .....	12
2.5	SPI interface .....	12
2.6	Temperature sensor .....	12
<b>3</b>	<b>Driving the CMV2000 .....</b>	<b>14</b>
	Supply settings.....	14
3.1	14	
3.2	Biasing .....	14
3.3	Digital input pins.....	14
3.4	Electrical IO specifications .....	15
3.4.1	Digital I/O CMOS/TTL DC specifications (see pin list for specific pins) .....	15
3.4.2	TIA/EIA-644A LVDS driver specifications (OUTx_N/P, OUTCLK_N/P, OUTCTR_N/P) .....	15
3.4.3	TIA/EIA-644A LVDS receiver specifications (LVDS_CLK_N/P) .....	15
3.5	Input clock.....	16
3.6	Frame rate calculation .....	17
3.7	Start-up sequence .....	18
3.8	Reset sequence.....	19
3.9	SPI programming .....	19
3.9.1	SPI write .....	19
3.9.2	SPI read.....	20
3.10	Requesting a frame .....	20
3.10.1	Internal exposure control .....	21
3.10.2	External exposure time .....	22
<b>4</b>	<b>Reading out the sensor .....</b>	<b>23</b>
4.1	LVDS data outputs.....	23
4.2	Low-level pixel timing .....	23

4.3	Read-out timing.....	24
4.3.1	10 Bit mode.....	24
4.3.2	12 Bit mode.....	25
4.4	Pixel remapping.....	25
4.4.1	16 Outputs.....	25
4.4.2	8 Outputs.....	26
4.4.3	4 Outputs.....	26
4.4.4	2 Outputs.....	26
4.4.5	Overview.....	27
4.5	Control channel.....	27
4.5.1	DVAL, LVAL, FVAL.....	28
4.6	Training data.....	29
<b>5</b>	<b>Image sensor programming.....</b>	<b>30</b>
5.1	Exposure modes.....	30
5.2	High dynamic range modes.....	30
5.2.1	Interleaved read-out.....	31
5.2.2	Piecewise linear response.....	32
5.2.3	Multi-frame read-out.....	34
5.3	Windowing.....	35
5.3.1	Single window.....	35
5.3.2	Multiple windows.....	35
5.4	Image flipping.....	37
5.5	Image subsampling.....	37
5.5.1	Simple subsampling.....	37
5.5.2	Advanced subsampling.....	38
5.6	Number of frames.....	39
5.7	Output mode.....	39
5.8	Training pattern.....	39
5.9	10-bit or 12-bit mode.....	39
5.10	Data rate.....	39
5.11	Power control.....	40
5.12	Offset and gain.....	40
5.12.1	Offset.....	40
5.12.2	Gain.....	41
5.13	Recommended register settings.....	42
5.13.1	Adjusting registers for optimal performance.....	42
<b>6</b>	<b>Register overview.....</b>	<b>43</b>

<b>7</b>	<b>Mechanical specifications .....</b>	<b>46</b>
7.1	Package drawing.....	46
7.1.1	95 pins $\mu$ PGA and LGA.....	46
7.1.2	92 pins LCC.....	47
7.2	Assembly drawing .....	48
7.3	Cover glass .....	49
7.4	Color filters .....	49
<b>8</b>	<b>Response curve .....</b>	<b>51</b>
<b>9</b>	<b>Spectral response.....</b>	<b>52</b>
9.1	5 $\mu$ m epi devices.....	52
9.2	12 $\mu$ m epi devices.....	52
<b>10</b>	<b>Angular response .....</b>	<b>53</b>
<b>11</b>	<b>Pinning .....</b>	<b>54</b>
11.1	Pin list .....	54
11.2	$\mu$ PGA and LGA pin layout.....	56
11.3	LCC pin layout .....	56
<b>12</b>	<b>Specification overview .....</b>	<b>57</b>
<b>13</b>	<b>Ordering info.....</b>	<b>59</b>
<b>14</b>	<b>Handling and soldering procedure .....</b>	<b>60</b>
14.1	Soldering .....	60
14.1.1	Manual soldering .....	60
14.1.2	Wave soldering .....	60
14.1.3	Reflow soldering .....	61
14.1.4	Soldering recommendations.....	61
14.2	Handling image sensors .....	61
14.2.1	ESD.....	61
14.2.2	Glass cleaning .....	61
14.2.3	Image sensor storing .....	61
<b>15</b>	<b>Evaluation kit .....</b>	<b>62</b>
<b>16</b>	<b>Additional information.....</b>	<b>63</b>



# 1 INTRODUCTION

## 1.1 OVERVIEW

The CMV2000 is a high speed CMOS image sensor with 2048 by 1088 pixels (2/3 optical inch) developed for machine vision applications. The image array consists of 5.5 $\mu$ m x 5.5 $\mu$ m pipelined global shutter pixels which allow exposure during read-out, while performing CDS operation. The image sensor has sixteen 10- or 12-bit digital LVDS outputs (serial). The image sensor also integrates a programmable gain amplifier and offset regulation. Each channel runs at 480Mbps maximum which results in 340FPS frame rate at full resolution. Higher frame rates can be achieved in row-windowing mode or row-subsampling mode. These modes are all programmable using the SPI interface. All internal exposure and read-out timings are generated by a programmable on-board sequencer. External triggering and exposure programming is also possible. Extended optical dynamic range can be achieved by multiple integrated high dynamic range modes.

## 1.2 FEATURES

- Capability to define up to 8 different windows
- Horizontal and vertical mirroring function
- Multiplexable output channels: 16, 8, 4 or 2 channel output possible
- LVDS control channel with read-out and frame information
- DDR LVDS output clock to sample data on the receiving end
- Selectable ADC Resolution: choose between maximum frame rate (10bit) or better image quality (12bit)
- Multiple High Dynamic Range options
- Configurable subsampling modes
- On-chip temperature sensor
- On-chip timing generation
- Sensor controllable via SPI-interface
- Available as panchromatic or with RGB Bayer-filter

## 1.3 SPECIFICATIONS

- Full well charge: 13.5Ke<sup>-</sup>
- Sensitivity: 5.56 V/lux.s (with microlenses @ 550nm)
- Dark noise: 13e<sup>-</sup> RMS
- Conversion gain: 0.075LSB/e<sup>-</sup> (10 bit mode) at unity gain
- Dynamic range: 60 dB
- Parasitic light sensitivity: 1/50000
- Dark current: 125 e<sup>-</sup>/s (@ 25°C die temperature)
- Fixed pattern noise: <1 LSB (10 bit mode, <0.1% of full swing, standard deviation on full image)
- Power consumption: 550mW to 1200mW
- 3.3V signaling
- 2048 by 1088 active pixels on a 5.5 $\mu$ m pitch
- Maximum frame rate of 340FPS
- Range of input clocks is 5 to 48MHz (Master clock) and 50 to 480MHz (LVDS clock)
- Range of custom ceramic packages available: 95 pins  $\mu$ PGA or LGA, or 92 pins LCC

**1.4 CONNECTION DIAGRAM**

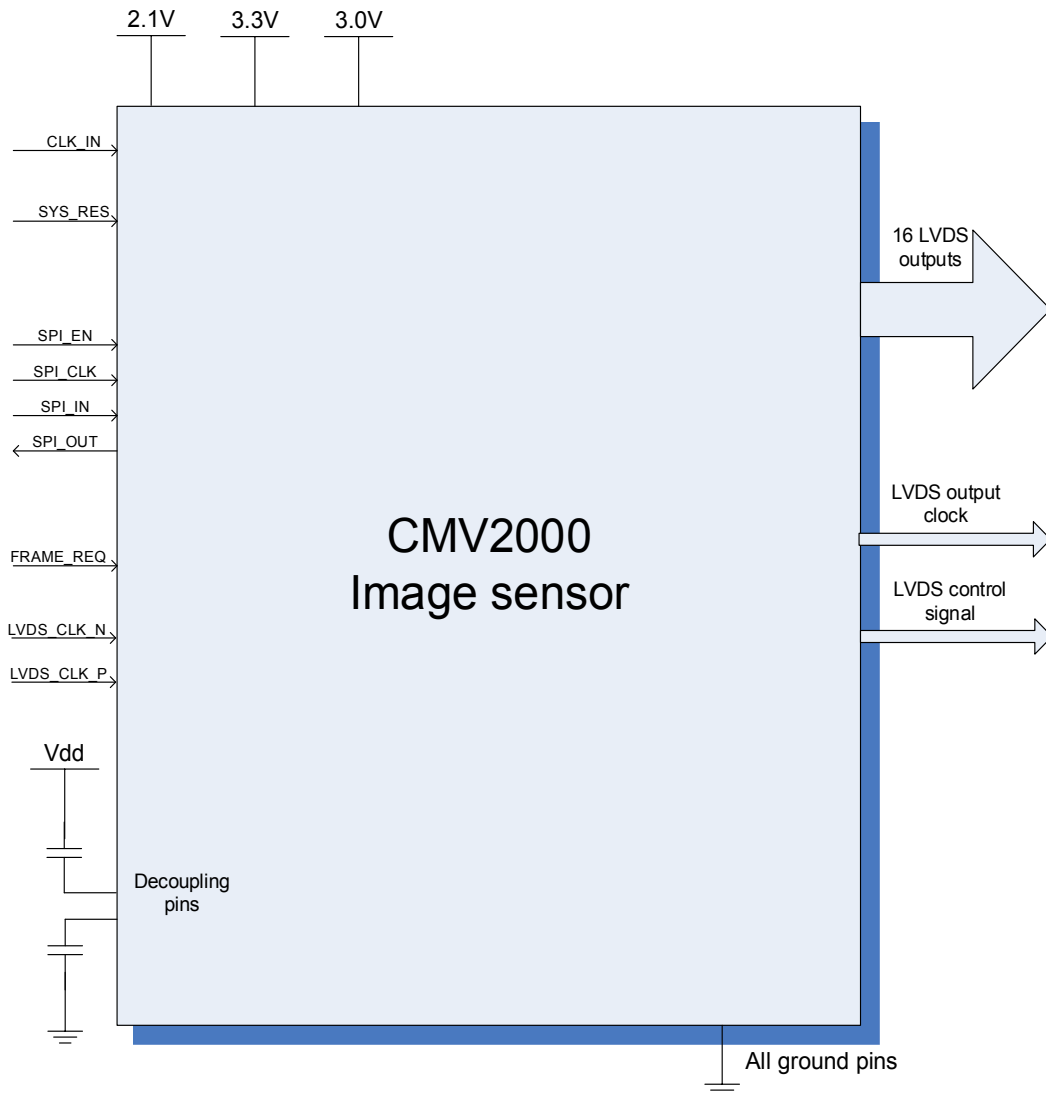

**FIGURE 1: CONNECTION DIAGRAM FOR THE CMV2000 IMAGE SENSOR**

Please look at the pin list for a detailed description of all pins and their proper connections. Some optional pins are not displayed on Figure 1 above. The exact pin numbers can be found in the pin list and on the package drawing.

## 2 SENSOR ARCHITECTURE

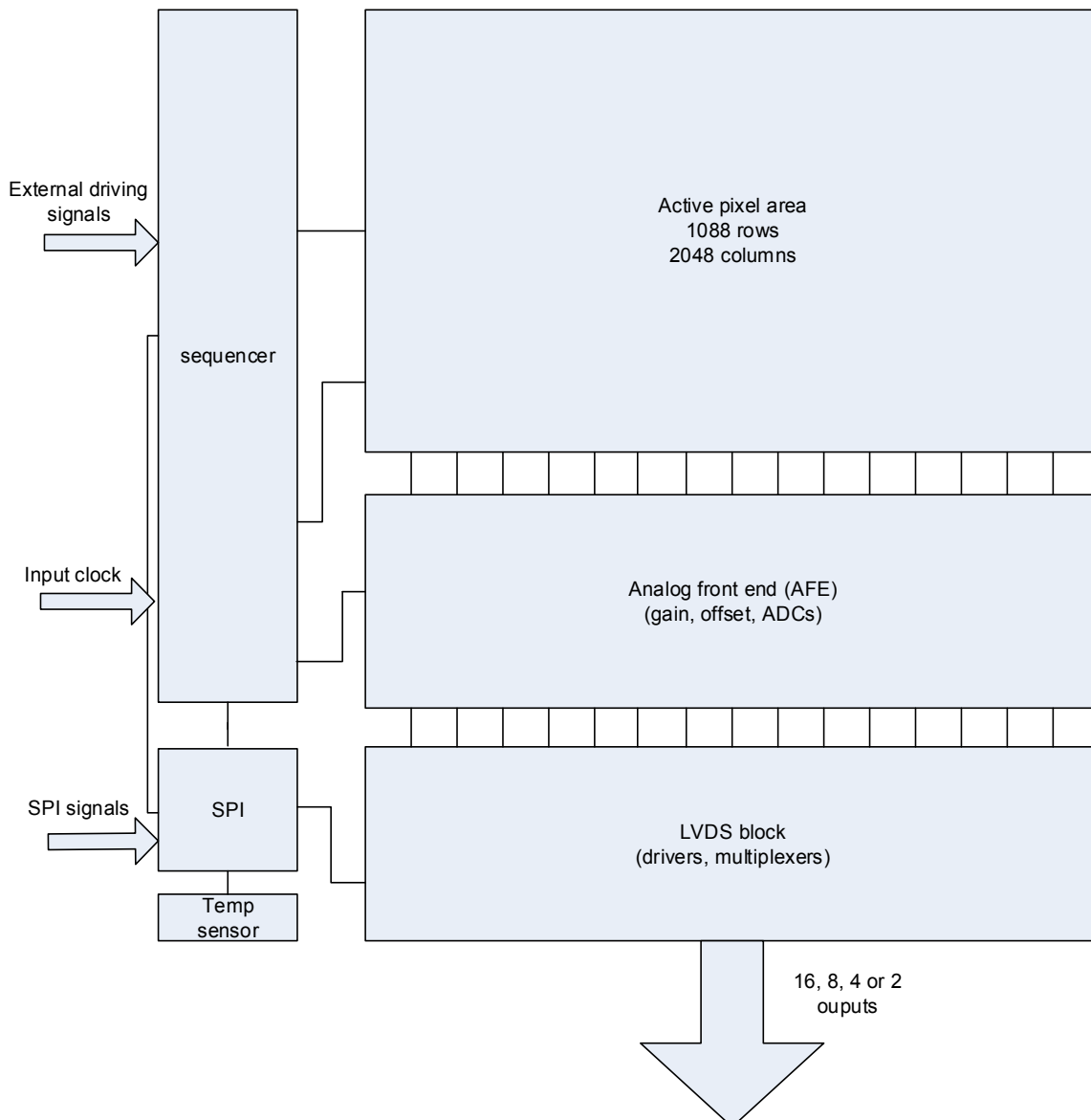

**FIGURE 2: SENSOR BLOCK DIAGRAM**

Figure 2 shows the image sensor architecture. The internal sequencer generates the necessary signals for image acquisition. The image is stored in the pixel (global shutter) and is then read out sequentially, row-by-row. On the pixel output, an analog gain of x1, x1.2, x1.4 and x1.6 is possible. The pixel values then pass to a column ADC cell, in which ADC conversion is performed. The digital signals are then read out over multiple LVDS channels. Each LVDS channel reads out 128 adjacent columns of the array. In the Y-direction, rows of interest are selected through a row-decoder which allows a flexible windowing. Control registers are foreseen for the programming of the sensor. These register parameters are uploaded via a four-wire SPI interface. A temperature sensor which can be read out over the SPI interface is also included.

### 2.1 PIXEL ARRAY

The pixel array consists of 2048 x 1088 square global shutter pixels with a pitch of 5.5 $\mu$ m (5.5 $\mu$ m x 5.5 $\mu$ m). This results in an optical area of close to 2/3 optical inch (12.7mm). This means that most off-the-shelf C-mount lenses can be used.

The pixels are designed to achieve maximum sensitivity with low noise and low PLS specifications. Micro lenses are placed on top of the pixels for improved fill factor and quantum efficiency (>50%).

## 2.2 ANALOG FRONT END

The analog front end consists of 2 major parts, a column amplifier block and a column ADC block.

The column amplifier prepares the pixel signal for the column ADC and applies analog gain if desired (programmable using the SPI interface). The column ADC converts the analog pixel value to a 10 or 12 bit value. A digital offset can also be applied to the output of the column ADC's. All gain and offset settings can be programmed using the SPI interface.

## 2.3 LVDS BLOCK

The LVDS block converts the digital data coming from the column ADC into standard serial LVDS data running at maximum 480Mbps. The sensor has 18 LVDS output pairs:

- 16 Data channels
- 1 Control channel
- 1 Clock channel

The 16 data channels are used to transfer 10-bit or 12-bit data words from sensor to receiver. The output clock channel transports a DDR clock, synchronous to the data on the other LVDS channels. This clock can be used at the receiving end to sample the data. The data on the control channel contains status information on the validity of the data on the data channels, among other useful sensor status information. Details on the LVDS timing and format can be found in Chapter 4 of this document.

LVDS requires parallel termination at the receiver side. So between LVDS\_CLK\_P (pin D1) and LVDS\_CLK\_N (pin D2) should be an external 100Ω resistor. Also all the LVDS outputs should all be externally terminated at the receiver side. See the TIA/EIA-644A standard for details.

## 2.4 SEQUENCER

The on-chip sequencer will generate all required control signals to operate the sensor from only a few external control clocks. This sequencer can be activated and programmed through the SPI interface. A detailed description of the SPI registers and sensor (sequencer) programming can be found in Chapter 5 of this document.

## 2.5 SPI INTERFACE

The SPI interface is used to load the sequencer registers with data. The data in these registers is used by the sequencer while driving and reading out the image sensor. Features like windowing, subsampling, gain and offset are programmed using this interface. The data in the on-chip registers can also be read back for test and debug of the surrounding system. Chapter 3.9 contains more details on SPI programming and timing.

## 2.6 TEMPERATURE SENSOR

A 16-bit digital temperature sensor is included in the image sensor and can be controlled by the SPI-interface. The on-chip temperature can be obtained by reading out the registers with address 126 and 127 (in burst mode, see Chapter 3.9.2 for more details on this mode).

A calibration of the temperature sensor is needed for absolute temperature measurements per device because the offset differs from device to device. The temperature sensor requires a running input clock (CLK\_IN), the other functions of the image sensor can be operational or in standby mode. The output value of the sensor is dependent on the input clock. A typical temperature sensor output vs. temperature curve at 40MHz can be found below. The die temperature will be about 10°C to 15°C higher than ambient temperature. The ceramic package has about the same temperature as the die.

The typical (offset) value of the temperature sensor at 0°C would be:  $1000 * \frac{f [MHz]}{40}$  DN. This offset can differ per device.  
 A typical slope would be around  $0.3 * \frac{40}{f [MHz]}$  °C/DN.

For example, for the calibration of a sensor you're reading out a temperature register value of 1066 at 35°C die temperature and an input frequency of 40MHz. If later you read out the temperature register value and it is 1184. You can calculate the ambient temperature back from that.

Ambient temperature =  $[(1184-1066) * 0.3 * 40 / 40MHz] + 35°C = 70.4°C$  die temperature.

Or vice versa, if you want to know the temperature register value for a die temperature of -10°C at 40MHz:

Register value =  $(-10°C - 35°C) * 40MHz / 40 * (1/0.3) + 1066 = 916$  DN

If you want a more accurate calibration you can calibrate the sensor at multiple temperatures, so you will have the exact value of the slope also. For most devices this should be around 0.29 to 0.31.

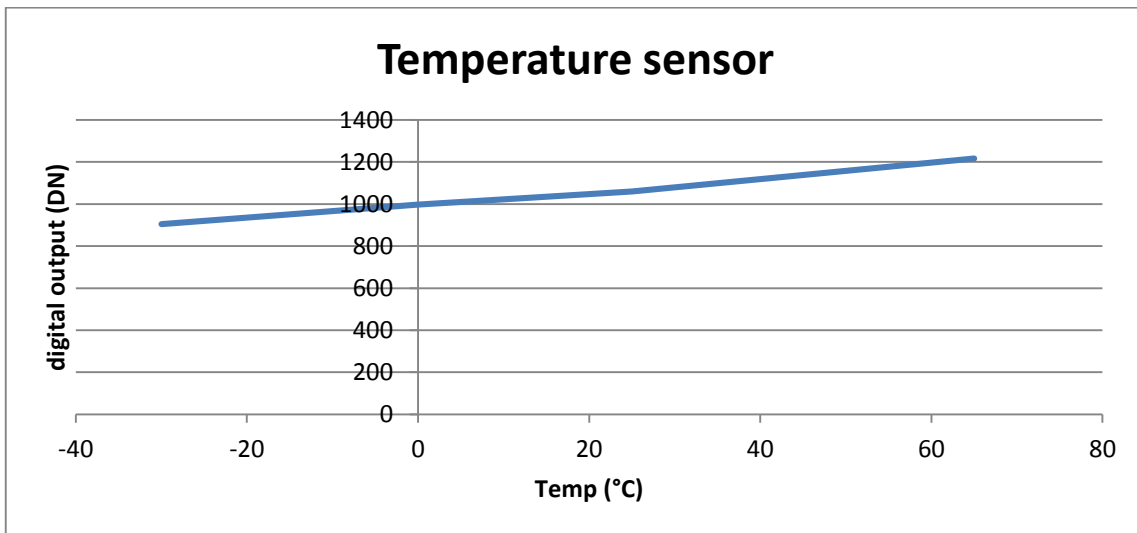

FIGURE 3: TYPICAL OUTPUT OF THE TEMPERATURE SENSOR OF THE CMV2000

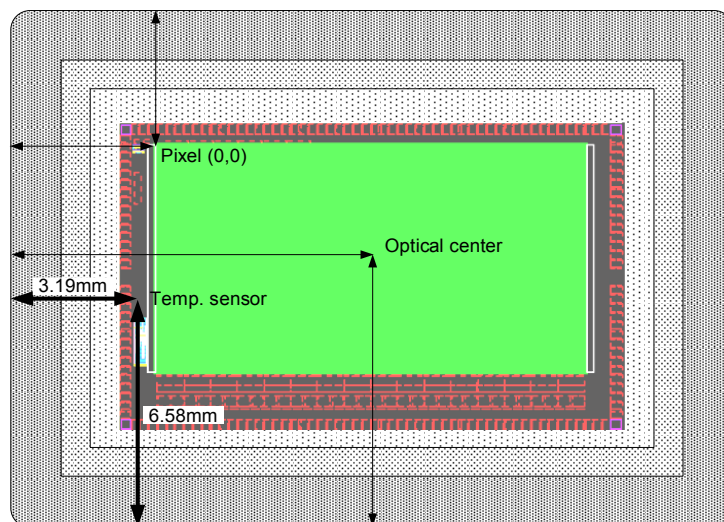

FIGURE 4: LOCATION OF THE TEMPERATURE SENSOR

### 3 DRIVING THE CMV2000

#### 3.1 SUPPLY SETTINGS

Supply name	Usage	Recommended value [V]	Range [V]	DC power nominal [mW]	DC current nominal [mA]	DC current peak [mA]
VDD20	LVDS, ADC	2.1	2.0 - 2.2	780	370	370
VDD33	Dig. I/O, PGA, SPI, ADC	3.3	3.0 - 3.6	220	65	65
VDDPIX	Pixel array power supply	3.0	2.3 - 3.6	60	20	115
Vres_h	Pixel reset pulse	3.3	3.0 - 3.6	50	15	15

The power figures are measured at 48MHz CLK\_IN speed in 16 channel mode while constantly grabbing images. When idle, the sensor will consume about 30% less energy. Reducing the amount of output channels will reduce power consumption of the VDD20 supply and will have the biggest impact on the power consumption.

All variations on the VDD33 and VDDPIX can contribute to variations (noise) on the analog pixel signal, which is seen as noise in the image. During the camera design precautions have to be taken to supply the sensor with very stable supply voltages to avoid this additional noise.

Because of the peak currents, decoupling is advised. Place large decoupling capacitors directly at the output of the voltage regulator to filter low noise and improve peak current supply. We advise 1x 330µF electrolytic, 1x 33µF tantalum and a 10µF ceramic capacitor per supply, directly at the output of the regulator.

Place small decoupling capacitors as close as possible to the sensor between supply pins and ground. We advise 1x 4.7µF and 1x 100nF ceramic capacitor per power supply pin (see pin list) and 1x 100µF ceramic capacitor per power supply plane (VDD20, VDDPIX, VDD33). Vres\_h doesn't need a 100µF capacitor. See the pin list for exact pin numbers for every supply. Analog and digital ground can be tied together.

#### 3.2 BIASING

For optimal performance, some pins need to be decoupled to ground or to VDD. Please refer to the pin list for a detailed description for every pin and the appropriate decoupling if applicable.

#### 3.3 DIGITAL INPUT PINS

The table below gives an overview of the external pins used to drive the sensor. The digital signals are sampled on the rising edge of the CLK\_IN, therefore the length of the signal applied to an input should be at least 1 CLK\_IN period to assure it has been detected. All digital I/O's have a capacitance of 2pF max.

Pin name	Description
CLK_IN	Master input clock, frequency range between 5 and 48 MHz
LVDS_CLK_N/P	High speed LVDS input clock, frequency range between 50 and 480 MHz
SYS_RES_N	System reset pin, active low signal. Resets the on-board sequencer and must be kept low during start-up. This signal should be at least one period of CLK_IN to assure detection on the rising edge of CLK_IN.
FRAME_REQ	Frame request pin. When a high level is detected on this pin the programmed number of frames is captured and sent by the sensor. This signal should be at least one period of CLK_IN to assure detection on the rising edge of CLK_IN.
SPI_IN	Data input pin for the SPI interface. The data to program the image sensor is sent over this pin.
SPI_EN	SPI enable pin. When this pin is high the data should be written/read on the SPI
SPI_CLK	SPI clock. This is the clock on which the SPI runs (max 48Mz)
T_EXP1	Input pin to program the exposure time externally. Optional
T_EXP2	Input pin to program the exposure time externally in HDR mode. Optional

### 3.4 ELECTRICAL IO SPECIFICATIONS

#### 3.4.1 DIGITAL I/O CMOS/TTL DC SPECIFICATIONS (SEE PIN LIST FOR SPECIFIC PINS)

Parameter	Description	Conditions	min	typ	max	Units
V <sub>IH</sub>	High level input voltage		2.0		VDD33	V
V <sub>IL</sub>	Low level input voltage		GND		0.8	V
V <sub>OH</sub>	High level output voltage	VDD=3.3V I <sub>OH</sub> =-2mA	2.4			V
V <sub>OL</sub>	Low level output voltage	VDD=3.3V I <sub>OL</sub> =2mA			0.4	V

#### 3.4.2 TIA/EIA-644A<sup>1</sup> LVDS DRIVER SPECIFICATIONS (OUT<sub>X\_N/P</sub>, OUTCLK<sub>N/P</sub>, OUTCTR<sub>N/P</sub>)

Parameter	Description	Conditions	min	typ	max	Units
V <sub>OD</sub>	Differential output voltage	Steady State, R <sub>L</sub> = 100Ω	247	350	454	mV
ΔV <sub>OD</sub>	Difference in V <sub>OD</sub> between complementary output states	Steady State, R <sub>L</sub> = 100Ω			50	mV
V <sub>OC</sub>	Common mode voltage	Steady State, R <sub>L</sub> = 100Ω	1.26	1.37	1.50	V
ΔV <sub>OC</sub>	Difference in V <sub>OC</sub> between complementary output states	Steady State, R <sub>L</sub> = 100Ω			50	mV
I <sub>OS,GND</sub>	Output short circuit current to ground	V <sub>OUTP</sub> =V <sub>OUTN</sub> =GND			24	mA
I <sub>OS,PN</sub>	Output short circuit current	V <sub>OUTP</sub> =V <sub>OUTN</sub>			12	mA

#### 3.4.3 TIA/EIA-644A LVDS RECEIVER SPECIFICATIONS (LVDS\_CLK<sub>N/P</sub>)

Parameter	Description	Conditions	min	typ	max	Units
V <sub>ID</sub>	Differential input voltage	Steady state	100	350	600	mV
V <sub>IC</sub>	Receiver input range	Steady state	0.0		2.4	V
I <sub>ID</sub>	Receiver input current	V <sub>INP INN</sub> =1.2V±50mV, 0 ≤ V <sub>INP INN</sub> ≤ 2.4V			20	μA
ΔI <sub>ID</sub>	Receiver input current difference	I <sub>INP</sub> - I <sub>INN</sub>			6	μA

<sup>1</sup> V<sub>OC</sub> is dependent on the VDD20 supply voltage, therefore these values differ from the TIA/EIA-644A spec.

### 3.5 INPUT CLOCK

The high speed LVDS input clock (LVDS\_CLK\_N/P) defines the output data rate of the CMV2000. The master clock (CLK\_IN) must be 10 or 12 times slower depending on the programmed bit mode setting. The maximum data rate of the output is 480Mbps which results in a LVDS\_CLK\_N/P of 480MHz and a CLK\_IN of 48MHz in 10-bit mode and 40MHz in 12-bit mode. The minimum frequencies are 5MHz for CLK\_IN and 50MHz for LVDS\_CLK\_N/P. Any frequency between the minimum and maximum can be applied by the user and will result in a corresponding output data rate.

CLK_IN	LVDS_CLK 10bit	LVDS_CLK 12bit
5 MHz	50 MHz	60 MHz
40 MHz	400 MHz	480 MHz
48 MHz	480 MHz	n/a

The rising edge LVDS input clock can have a limited delay with respect to the rising edge of the master input clock, depending on clock speed. In Figure 5 below, the skew limits are shown for different clock speeds and for an LVDS clock that rises before and after the master input clock. To assure proper working of the sensor, the skew of the LVDS clock should always fall within these limits, shown as the green area.

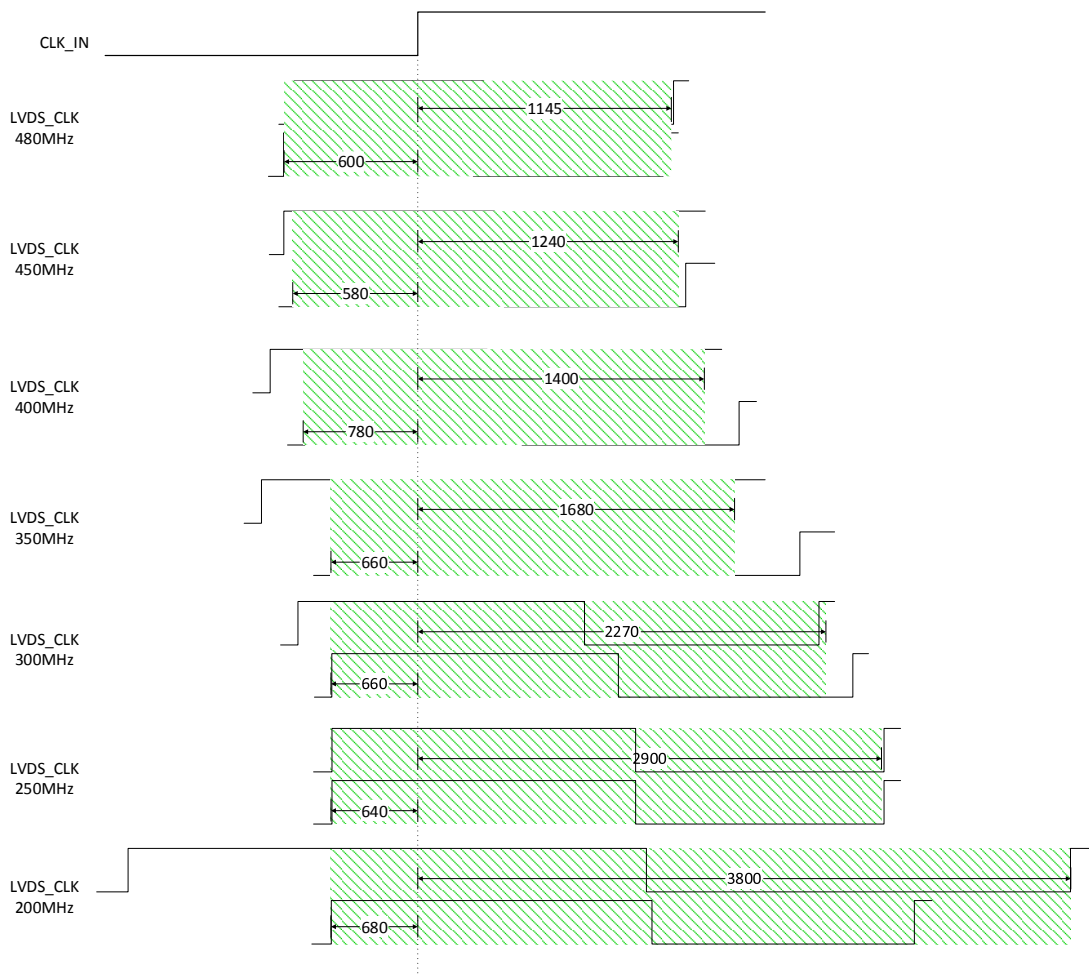

FIGURE 5: LVDS CLOCK DELAY VERSUS MASTER CLOCK



### 3.6 FRAME RATE CALCULATION

The frame rate is defined by 2 main factors.

1. Exposure time
2. Read-out time

To simplify the calculation we will assume that the exposure time is shorter than the read-out time and that the sensor is operating at default settings, taking a full resolution 10-bit image at 48MHz through 16 outputs. This means that the frame rate will be defined only by the read-out time because the exposure time happens in parallel with the read-out. The read-out time is defined by:

1. Output clock speed: max 240MHz
2. ADC mode: 10 or 12 bit
3. Number of lines read-out
4. Number of LVDS outputs used: max 16 outputs

If any of these parameters is changed, it will have an impact on the frame rate. In default operation this will result in 340FPS. The total read-out time is composed of two parts: FOT (frame overhead time) and image read-out time.

The FOT is defined as:

$$FOT = \left( fot\_length + \left( 2 * \frac{16}{\#outputs\ used} \right) \right) * 129 * master\ clock\ period$$

With fot\_length (register 73) at its default value of 10, this results in 32.25µs frame overhead time.

The image read-out time is defined as:

$$Image\ read-out\ time = \left( 129 * master\ clock\ period * \frac{16}{\#outputs\ used} \right) * nr\_lines$$

Reading out a full resolution image, this results in 2.924ms image read-out time.

The total read-out time is now the sum of the FOT and the image read-out time, which results in 32.25µs + 2.924ms or 2.9525ms to read out a single full resolution image. The frame rate is thus 338FPS.

The table below gives some examples of how the frame rate increases when reading out a smaller frame in 10 bit mode.

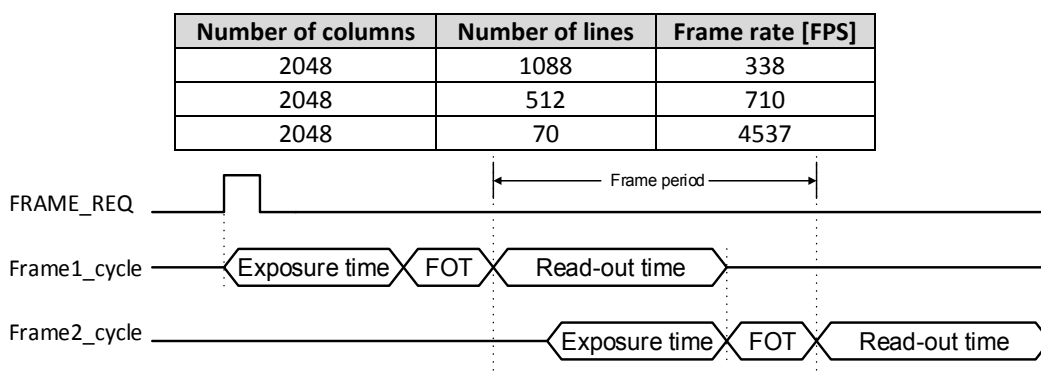
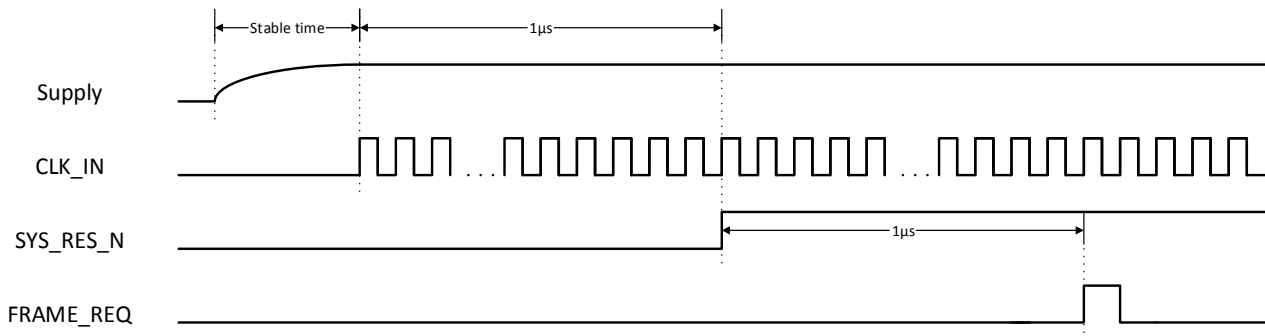

FIGURE 6: FRAME PERIOD

When the exposure time is greater than the read-out time, the frame rate is mostly defined by the exposure time itself (as the exposure time will be much longer than the FOT).

### 3.7 START-UP SEQUENCE

The sequence as described in Figure 6 should be followed when the sensor is started up in default output mode (480Mbps, 10bit resolution). There is no specific startup sequence for the power supplies needed.



**FIGURE 7: START-UP SEQUENCE FOR 480MBPS @ 10-BIT**

The CLK\_IN master clock (48MHz for 480Mbps in 10-bit mode) should only start after the rise time of the supplies. The external reset pin should be released at least 1µs after the supplies have become stable. The first frame can be requested 1µs after the reset pin has been released.

If the register settings need to be changed (e.g. when using 12-bit mode), this can be done through an SPI upload 1µs after the rising edge on the SYS\_RES\_N pin, as described in Figure 9. In this case, the FRAME\_REQ pulse must not be sent until after the SPI upload is completed, plus a settling time. This settling time is to ensure that the changes programmed in the SPI upload have taken effect before an image is captured. The main factor that determines this settling time is the change in ADC gain, because the voltage over the ramp capacitor has to settle. For typical applications, where the ADC gain is changed from the default value of 32 to a value that saturates the ADC output (40 to 45 at 48MHz), the settling time is 5ms. In extreme cases, when the gain is changed from default to the maximum value, the settling time will increase to 20ms.

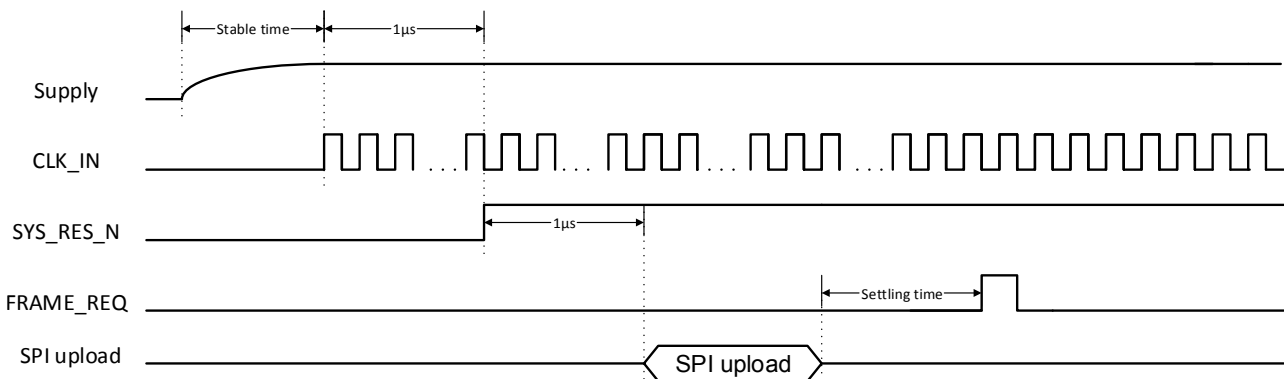

**FIGURE 8: START-UP SEQUENCE FOR 12-BIT MODE**

### 3.8 RESET SEQUENCE

If a sensor reset is necessary while the sensor is running the sequence in Figure 8 should be followed. The on-board sequencer will be reset and all programming registers will return to their default start-up values when a falling edge is detected on the SYS\_RES\_N pin. As with the start-up sequence, there is a minimum time of 1µs plus a settling time needed before a FRAME\_REQ pulse can be sent, to allow the gain settings to settle at their default value.

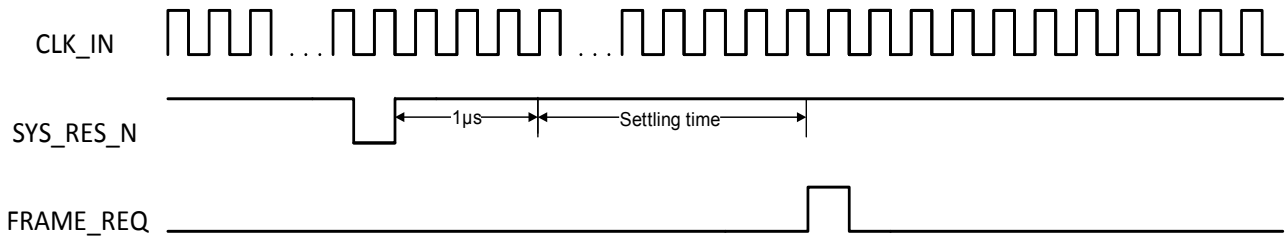

FIGURE 9: RESET SEQUENCE

When register settings are uploaded after the reset (e.g. when changing the bit mode), the following sequence should be followed.

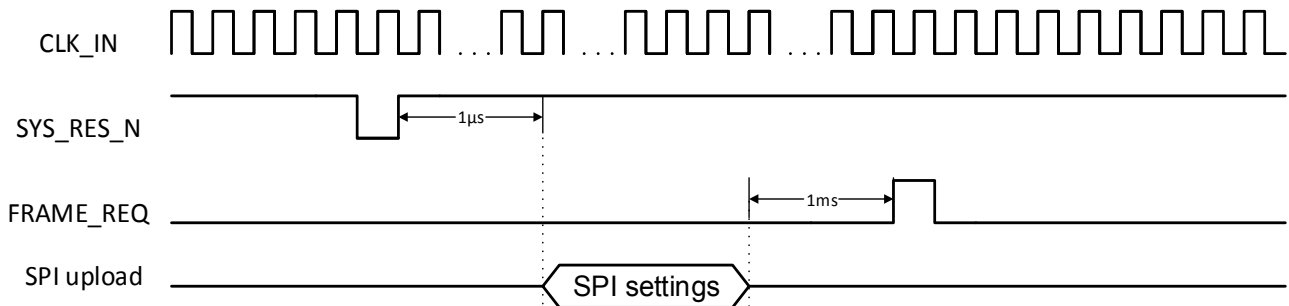

FIGURE 10: RESET SEQUENCE WHEN CHANGING BIT MODE

### 3.9 SPI PROGRAMMING

Programming the sensor is done by writing the appropriate values to the on-board registers. These registers can be written over a simple serial interface (SPI). The details of the timing and data format are described below. The data written to the programming registers can also be read out over this same SPI interface.

#### 3.9.1 SPI WRITE

The timing to write data over the SPI interface can be found below.

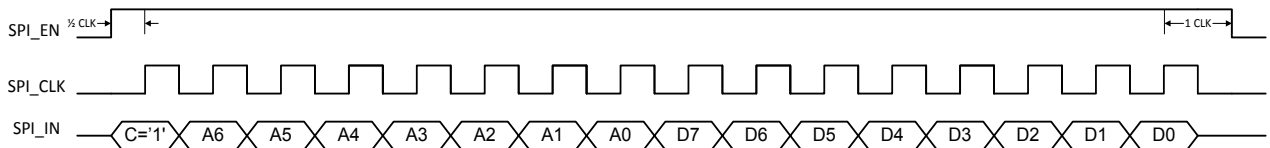

FIGURE 11: SPI WRITE TIMING

The data is sampled by the CMV2000 on the rising edge of the SPI\_CLK. The SPI\_CLK has a maximum frequency of 48MHz. The SPI\_EN signal has to be high for half a clock period before the first databit is sampled. After the last databit is sent, SPI\_EN has to remain high for 1 clock period and SPI\_CLK has to receive a final falling edge to complete the write operation.

One write action contains 16 bits:

- One control bit: First bit to be sent, indicates whether a read ('0') or write ('1') will occur on the SPI interface.
- 7 address bits: These bits form the address of the programming register that needs to be written. The address is sent MSB first.
- 8 data bits: These bits form the actual data that will be written in the register selected with the address bits. The data is written MSB first.

When several sensor registers need to be written, the timing above can be repeated with SPI\_EN remaining high all the time. See Figure 12 below for an example of 2 registers being written in burst.

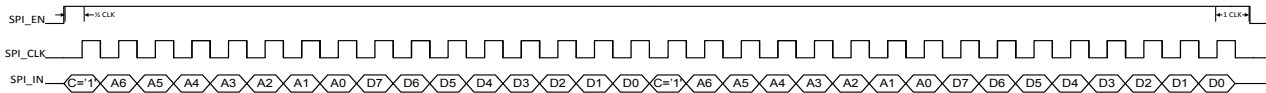

FIGURE 12: SPI WRITE TIMING FOR 2 REGISTERS IN BURST

All registers should be updated during IDLE time. The sensor is not IDLE during a frame burst (between start of integration of first frame and read-out of last pixel of last frame).

Registers 35-38, 40-69, 100-103 can be updated during IDLE or FOT. Registers 1-34 and 70-71 can always be updated but it is recommended to update these during IDLE or FOT to minimize image effects. Registers 78-79 can always be updated without disrupting the imaging process.

### 3.9.2 SPI READ

The timing to read data from the registers over the SPI interface can be found below.

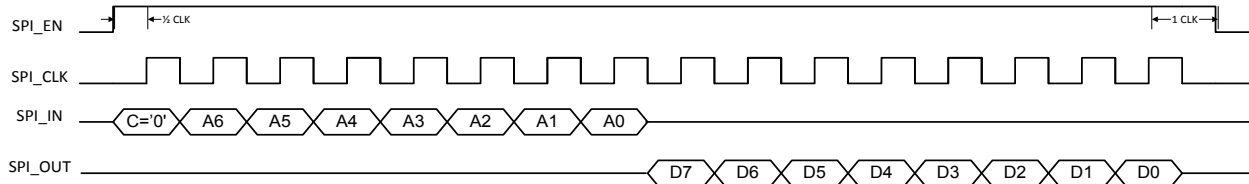

FIGURE 13: SPI READ TIMING

To indicate a read action over the SPI interface, the control bit on the SPI\_IN pin is made '0'. The address of the register being read out is sent immediately after this control bit (MSB first). After the LSB of the address bits, the data is launched on the SPI\_OUT pin on the falling edge of the SPI\_CLK. This means that the data should be sampled by the receiving system on the rising edge of the SPI\_CLK. The data comes over the SPI\_OUT with MSB first. When reading out the temperature sensor over the SPI, addresses 126 and 127 should be read-out in burst mode (keep SPI\_EN high)

### 3.10 REQUESTING A FRAME

After starting up the sensor (see Chapter 3.7), a number of frames can be requested by sending a FRAME\_REQ pulse. The number of frames can be set by programming the appropriate register (addresses 70 and 71). The default number of frames to be grabbed is 1.

In internal-exposure-time mode, the exposure time will start after this FRAME\_REQ pulse. In the external-exposure-time mode, the read-out will start after the FRAME\_REQ pulse. Both modes are explained into detail in the chapters below.

### 3.10.1 INTERNAL EXPOSURE CONTROL

In this mode, the exposure time is set by programming the appropriate registers (address 42-44) of the CMV2000. After the high state of the FRAME\_REQ pulse is detected, the exposure time will start after a delay of 133 clock cycles, see AN16 – Exposure Timings for all the timing details. When the exposure time ends, the pixels are sampled and prepared for read-out. This sequence is called the frame overhead time (FOT). Immediately after the FOT, the frame is read-out automatically. If more than one frame is requested, the exposure of the next frame starts already during the read-out of the previous one. See the diagram below for more details.

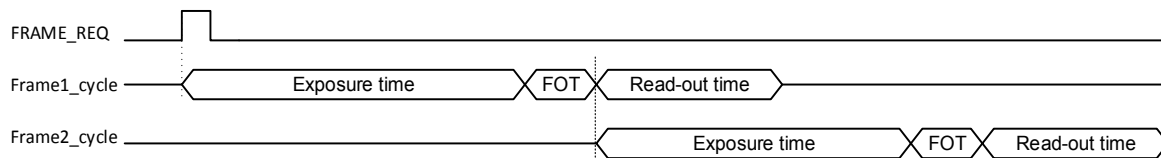

**FIGURE 14: REQUEST FOR 2 FRAMES IN INTERNAL- EXPOSURE-TIME MODE**

When the exposure time is shorter than the read-out time, the FOT and read-out of the next frame will start immediately after the read-out of the previous frame. Keep in mind that the next FRAME\_REQ pulse has to occur after the FOT of the current frame. For an exact calculation of the exposure time see Chapter 5.1.

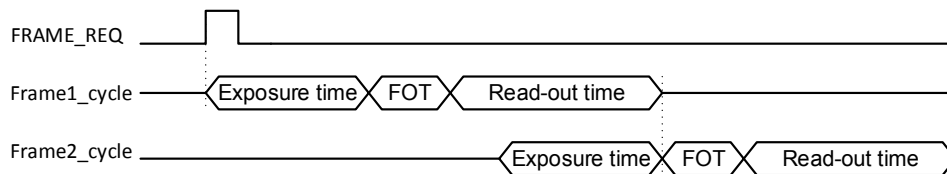
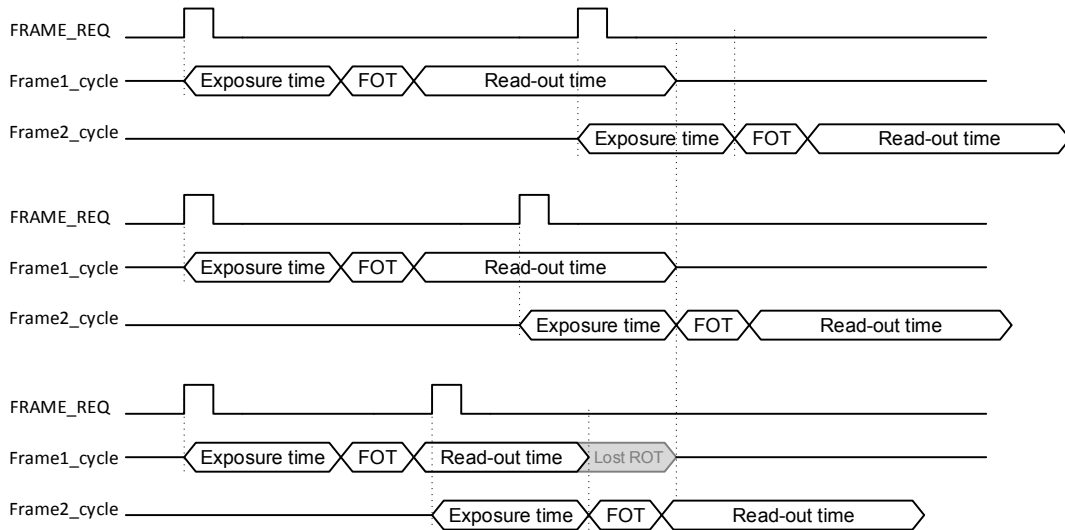

**FIGURE 15: REQUEST FOR 2 FRAMES IN INTERNAL EXPOSURE MODE WITH EXPOSURE TIME < READ-OUT TIME**

If a next FRAME\_REQ pulse is applied during exposure time or FOT of the current frame, it will be ignored and no new frame is requested. FRAME\_REQ should occur during or after the read-out time of the current frame.

If the exposure time is shorter than the read-out time, keep in mind that when you apply a next FRAME\_REQ pulse during the read-out of the current frame, the exposure of that new frame will start immediately. So you have to keep enough time between the two FRAME\_REQ pulses so the read-out times don't overlap. If the FOT of the next frame starts during the read-out of the current frame, that read-out will be aborted immediately as shown in Figure 16. If the exposure time is longer than the read-out time, the read-out times of two consecutive frames can't overlap and won't cause a problem. The minimum time between two FRAME\_REQ pulses should be:

$$exposure\ time + FOT + (Readout\ time - Exposure\ time) = FOT + Readout\ time$$



**FIGURE 16: THE TIMING EFFECT OF TWO REQUESTS FOR 1 FRAME IN INTERNAL EXPOSURE MODE**

### 3.10.2 EXTERNAL EXPOSURE TIME

The exposure time can also be programmed externally by using the T\_EXP1 input pin. This mode needs to be enabled by setting the appropriate register (address 41). In this case, the exposure starts when a high state is detected on the T\_EXP1 pin. When a high state is detected on the FRAME\_REQ input, the exposure time stops and the read-out will start automatically. A new exposure can start by sending a pulse to the T\_EXP1 pin during or after the read-out of the previous frame. The minimum time between T\_EXP1 and FRAME\_REQ is 1 master clock cycle and between FRAME\_REQ and T\_EXP1 is FOT. For an exact calculation of the exposure time see Chapter 5.1.

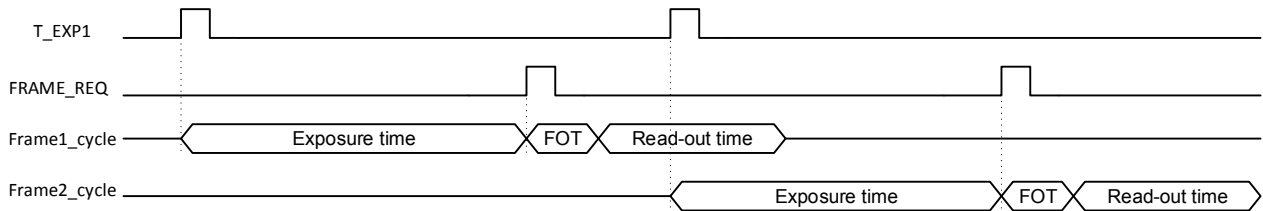

**FIGURE 17: REQUEST FOR 2 FRAMES USING EXTERNAL-EXPOSURE-TIME MODE**

## 4 READING OUT THE SENSOR

### 4.1 LVDS DATA OUTPUTS

The CMV2000 has LVDS (low voltage differential signaling) outputs to transport the image data to the surrounding system. Next to 16 data channels, the sensor also has two other LVDS channels for control and synchronization of the image data. In total, the sensor has 18 LVDS output pairs (2 pins for each LVDS channel):

- 16 Data channels
- 1 Control channel
- 1 Clock channel

This means that a total of 36 pins of the CMV2000 are used for the LVDS outputs (32 for data + 2 for LVDS clock + 2 for control channel). See the pin list for the exact pin numbers of the LVDS outputs.

The 16 data channels are used to transfer the 10-bit or 12-bit pixel data from the sensor to the receiver in the surrounding system.

The output clock channel transports a clock, synchronous to the data on the other LVDS channels. This clock can be used at the receiving end to sample the data. This clock is a DDR clock which means that the frequency will be half of the output data rate. When 480Mbps output data rate is used, the LVDS output clock will be 240MHz.

The data on the control channel contains status information on the validity of the data on the data channels. Information on the control channel is grouped in 10-bit or 12-bit words that are transferred synchronous to the 16 data channels.

### 4.2 LOW-LEVEL PIXEL TIMING

Figure 18 and Figure 19 show the timing for transfer of 10-bit and 12-bit pixel data over one LVDS output. To make the timing more clear, the figures show only the p-channel of each LVDS pair. The data is transferred LSB first, with the transfer of bit D0 during the high phase of the DDR output clock OUTCLK.

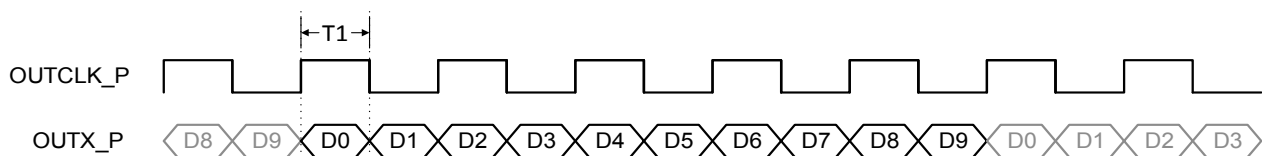

**FIGURE 18: 10-BIT PIXEL DATA ON AN LVDS CHANNEL**

The time 'T1' in Figure 18 is 1/10<sup>th</sup> of the period of the CLK\_IN input clock. If a frequency of 48MHz is used for CLK\_IN (max in 10-bit mode) and 480MHz for LVDS\_CLK\_N/P this results in a 240MHz OUTCLK frequency.

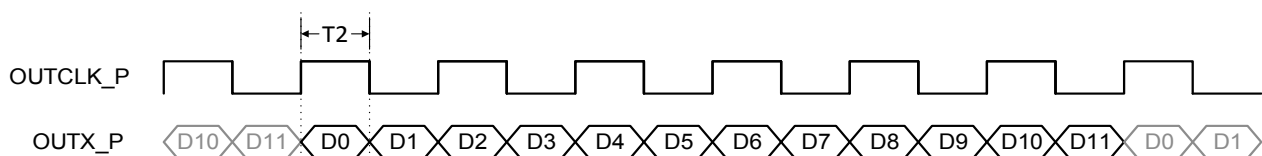

**FIGURE 19: 12-BIT PIXEL DATA ON AN LVDS CHANNEL**

The time 'T2' in Figure 19 is 1/12<sup>th</sup> of the period of the CLK\_IN input clock. When a frequency of 40MHz is used for CLK\_IN (max in 12-bit mode) and 480MHz for LVDS\_CLK\_N/P this results in a 240MHz OUTCLK frequency.

### 4.3 READ-OUT TIMING

The read-out of image data is grouped in bursts of 128 pixels per channel. Each pixel is either 10 or 12 bits of data (see Chapter 4.2). One complete pixel period equals one period of the input clock CLK\_IN. For details on pixel remapping and pixel vs. channel location please see Chapter 4.4 of this document. An overhead time exists between two bursts of 128 pixels. This overhead time has the same length of one pixel read-out (i.e. the length of 10 or 12 bits at the selected data rate or one CLK\_IN period). For details on how to program the sequencer for different output modes, see Chapter 5.7.

#### 4.3.1 10 BIT MODE

In this chapter, the read-out timing for the default 10 bit mode is explained. In this mode the maximum frame rate of 340FPS can be reached. To simplify the figures below, the timing for only one LVDS channel is shown in every case.

##### 4.3.1.1 16 OUTPUT CHANNELS

By default, all 16 data output channels are used to transmit the image data. This means that an entire row of image data is transferred in one slot of 128 pixel periods ( $16 \times 128 = 2048$ ). This results in a maximum frame rate of 340FPS.

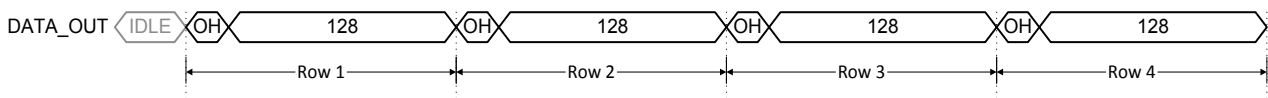

**FIGURE 20: OUTPUT TIMING IN DEFAULT 16 CHANNEL MODE**

##### 4.3.1.2 8 OUTPUT CHANNELS

When only 8 LVDS output channels are used, the read-out of one row takes  $(2 \times 128) + (2 \times 1)$  CLK\_IN periods. The maximum frame rate is reduced with a factor of 2 compared to 16 channel mode.

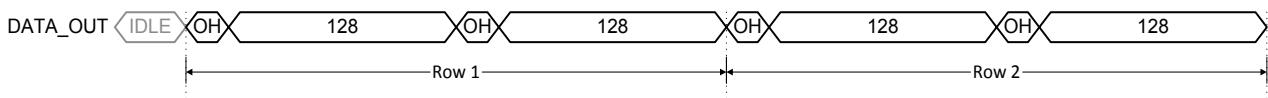

**FIGURE 21: OUTPUT TIMING IN 8 CHANNEL MODE**

##### 4.3.1.3 4 OUTPUT CHANNELS

When only 4 LVDS output channels are used, the read-out of one row takes  $(4 \times 128) + (4 \times 1)$  CLK\_IN periods. The maximum frame rate is reduced with a factor of 4 compared to 16 channel mode.

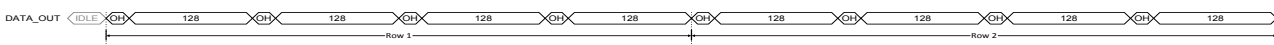

**FIGURE 22: OUTPUT TIMING IN OF 4 CHANNEL MODE**

##### 4.3.1.4 2 OUTPUT CHANNELS

When only 2 LVDS output channels are used, the read-out of one row takes  $(8 \times 128) + (8 \times 1)$  CLK\_IN periods. The maximum frame rate is reduced with a factor of 8 compared to 16 channel mode.



**FIGURE 23: OUTPUT TIMING IN 2 CHANNEL MODE**



### 4.3.2 12 BIT MODE

In 12 bit mode, the analog-to-digital conversion takes 4x longer to complete. This causes the frame rate to drop to 70FPS when 480MHz is used for LVDS\_CLK\_N/P. Due to this extra conversion time, the sensor automatically multiplexes to 4 outputs when 12 bit is used. To simplify the figures below, the timing for only one LVDS channel is shown in every case.

#### 4.3.2.1 4 OUTPUT CHANNELS

By default, the CMV2000 uses only 4 LVDS output channels in 12 bit mode. This means that the read-out of one row takes  $(4 \times 128) + (4 \times 1)$  CLK\_IN periods.

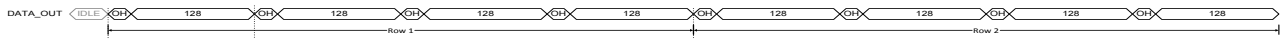

FIGURE 24: OUTPUT TIMING IN OF 4 CHANNEL MODE

#### 4.3.2.2 2 OUTPUT CHANNELS

When only 2 LVDS output channels are used, the read-out of one row takes  $(8 \times 128) + (8 \times 1)$  CLK\_IN periods. The maximum frame rate is reduced with a factor of 2 compared to 4-channel mode.



FIGURE 25: OUTPUT TIMING IN 2 CHANNEL MODE

## 4.4 PIXEL REMAPPING

Depending on the number of output channels, the pixels are read out by different channels and come out at a different moment in time. With the details from the next chapters, the end user is able to remap the pixel values at the output to their correct image array location.

### 4.4.1 16 OUTPUTS

Figure 26 below shows the location of the image pixels versus the output channel of the image sensor.

16 bursts of 128 pixels happen in parallel on the data outputs. This means that one complete row is read out in one burst. The amount of rows that will be read out depends on the value in the corresponding register. By default there are 1088 rows being read out.

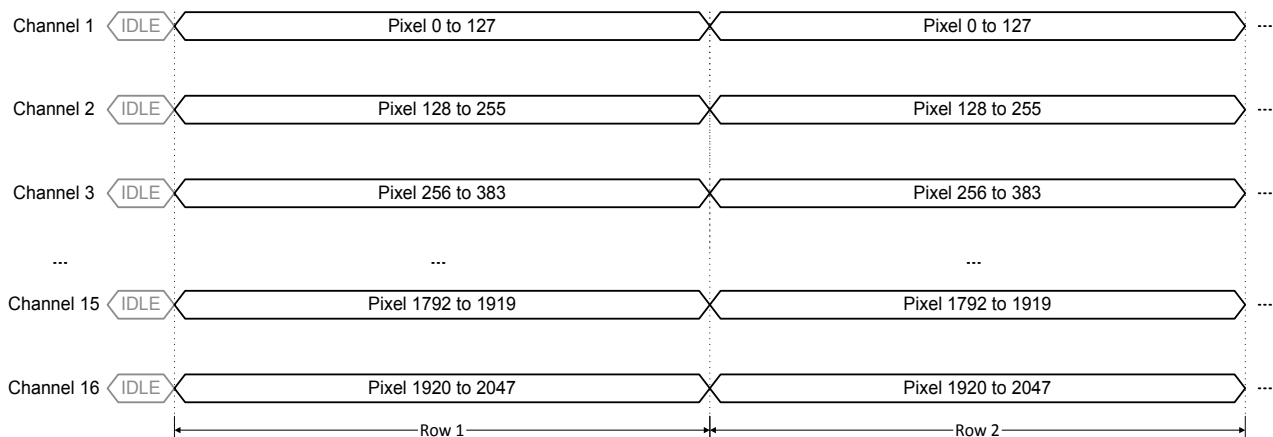
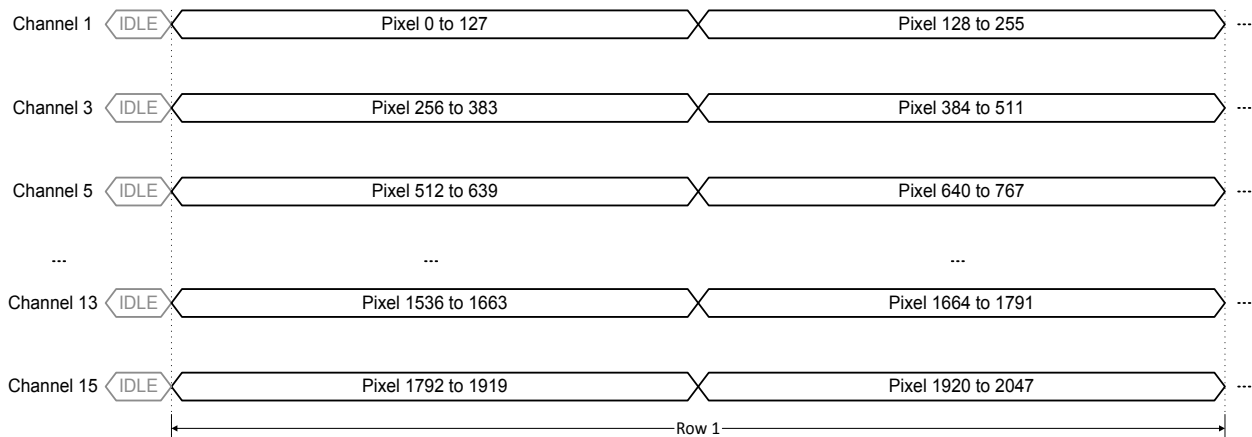

FIGURE 26: PIXEL REMAPPING FOR 16 OUTPUT CHANNELS

#### 4.4.2 8 OUTPUTS

When only 8 outputs are used, the pixel data is placed on the outputs as detailed in Figure 27. 8 bursts of 128 pixels happen in parallel on the data outputs. This means that one complete row is read out in two bursts. The time needed to read out one row is doubled compared to when 16 outputs are used. Channel 2, 4, 6...16 are not being used in this mode, so they can be turned off by setting the correct bits in the register with addresses 80-82. Turning off these channels will reduce the power consumption of the chip.

The amount of rows that will be read out can be set in the register. By default there are 1088 rows being read out.

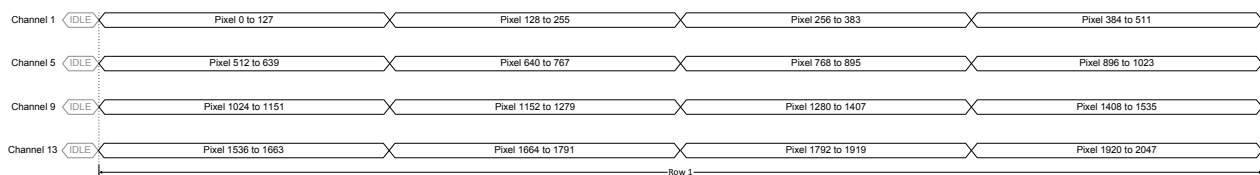

**FIGURE 27: PIXEL REMAPPING FOR 8 OUTPUT CHANNELS**

#### 4.4.3 4 OUTPUTS

When only 4 outputs are used, the pixel data is placed on the outputs as detailed in Figure 28. 4 bursts of 128 pixels happen in parallel on the data outputs. This means that one complete row is read out in four bursts. The time needed to read out one row is 4x longer compared to when 16 outputs are used. Only channel 1, 5, 9 and 13 are being used in this mode, so the remaining channels can be turned off by setting the correct bits in the register with addresses 80-82. Turning off these channels will reduce the power consumption of the chip.

The amount of rows that will be read out can be set in the register. By default there are 1088 rows being read out.

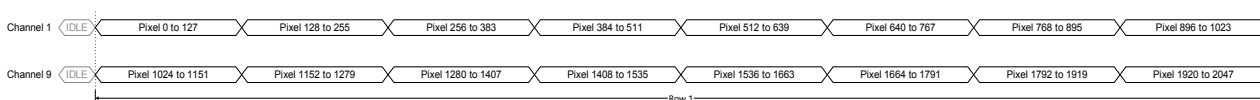

**FIGURE 28: PIXEL REMAPPING FOR 4 OUTPUT CHANNELS**

#### 4.4.4 2 OUTPUTS

When only 2 outputs are used, the pixel data is placed on the outputs as detailed in Figure 29. 2 bursts of 128 pixels happen in parallel on the data outputs. This means that one complete row is read out in 8 bursts. The time needed to read out one row is 8x longer compared to when 16 outputs are used. Only channel 1 and 9 are being used in this mode, so the remaining channels can be turned off by setting the correct bits in the register with addresses 80-82. Turning off these channels will reduce the power consumption of the chip.

The amount of rows that will be read out can be set in the register. By default there are 1088 rows being read out.



**FIGURE 29: PIXEL REMAPPING FOR 2 OUTPUT CHANNELS**

#### 4.4.5 OVERVIEW

All outputs are always used to send data, but if you use less than 16 channels, some channels will have duplicate data. For example if you multiplex to 4 channels, outputs 6, 7 and 8 will have identical data as output 5. Below you see an overview of which channel data is on which output at a certain output mode.

MUX to	OUT 1	OUT 2	OUT 3	OUT 4	OUT 5	OUT 6	OUT 7	OUT 8	OUT 9	OUT 10	OUT 11	OUT 12	OUT 13	OUT 14	OUT 15	OUT 16
16	CH1	CH2	CH3	CH4	CH5	CH6	CH7	CH8	CH9	CH10	CH11	CH12	CH13	CH14	CH15	CH16
8	CH1	CH1	CH3	CH3	CH5	CH5	CH7	CH7	CH9	CH9	CH11	CH11	CH13	CH13	CH15	CH15
4	CH1	CH1	CH1	CH1	CH5	CH5	CH5	CH5	CH9	CH9	CH9	CH9	CH13	CH13	CH13	CH13
2	CH1	CH1	CH1	CH1	CH1	CH1	CH1	CH1	CH9	CH9	CH9	CH9	CH9	CH9	CH9	CH9

#### 4.5 CONTROL CHANNEL

The CMV2000 has one LVDS output channel dedicated for the valid data synchronization and timing of the output channels. The end user must use this channel to know when valid image data or training data is available on the data output channels. Data is transferred in 10-bit or 12-bit word format. Every bit has a specific function, which is described in the following table, but only the DVAL, LVAL and FVAL signal are necessary to know when to sample the image data.

Bit	Function	Description
[0]	DVAL	Indicates valid pixel data on the outputs
[1]	LVAL	Indicates validity of the read-out of a row
[2]	FVAL	Indicates the validity of the read-out of a frame
[3]	SLOT	Indicates the overhead period before 128-pixel bursts (*)
[4]	ROW	Indicates the overhead period before the read-out of a row (*)
[5]	FOT	Indicates when the sensor is in FOT (sampling of image data in pixels) (*)
[6]	INTE1	Indicates when pixels of integration block 1 are integrating (*)
[7]	INTE2	Indicates when pixels of integration block 2 are integrating (*)
[8]	'0'	Constant zero
[9]	'1'	Constant one
[10]	'0'	Constant zero
[11]	'0'	Constant zero

(\*)Note: These bits are purely informational and are not required to know when the data is valid.

INTE1 and INTE2 will be low when FOT is high, so the exposure during the  $0.43 \cdot \text{fot\_length}$  overlap (see Chapter 5.1), will not be visible in the INTE1 and INTE2 bits.

Pins H2 (TDIG1) and G2 (TDIG2) can be programmed to map the state of control channel bits [0] (DVAL), [1] (LVAL), [2] (FVAL), [6] (INTE1) or [7] (INTE2) with registers 108 (T\_dig1) and 109 (T\_dig2).

Register 108/109 Value	TDIG1	TDIG2
0	INTE1	INTE1
1	INTE2	INTE2
2	DVAL	DVAL
3	LVAL	LVAL
4	FVAL	FVAL

### 4.5.1 DVAL, LVAL, FVAL

The first three bits of the control word must be used to identify valid data and the read-out status.

Next figure shows the timing of the DVAL, LVAL and FVAL bits of the control channel with an example of the read-out of a frame of 3 rows (default is 1088 rows). This example uses the default mode of 16 outputs in 10 bit mode.

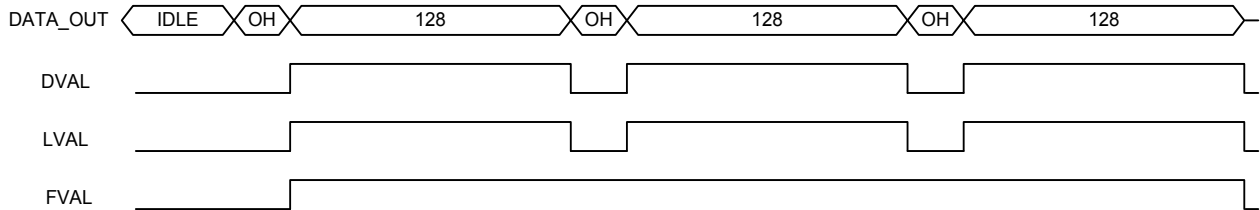

FIGURE 30: DVAL, LVAL AND FVAL TIMING IN 16 OUTPUT MODE

When only 8 outputs are used, the line read-out time is 2x longer. The control channel takes this into account and the timing in this mode is shown in Figure 31 and Figure 32. The timing extrapolates identically for 4 and 2 outputs.

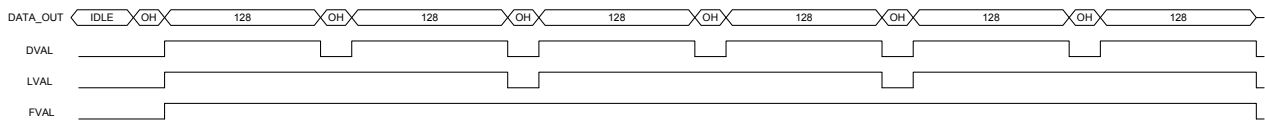

FIGURE 31: DVAL, LVAL AND FVAL TIMING IN 8 OUTPUT MODE

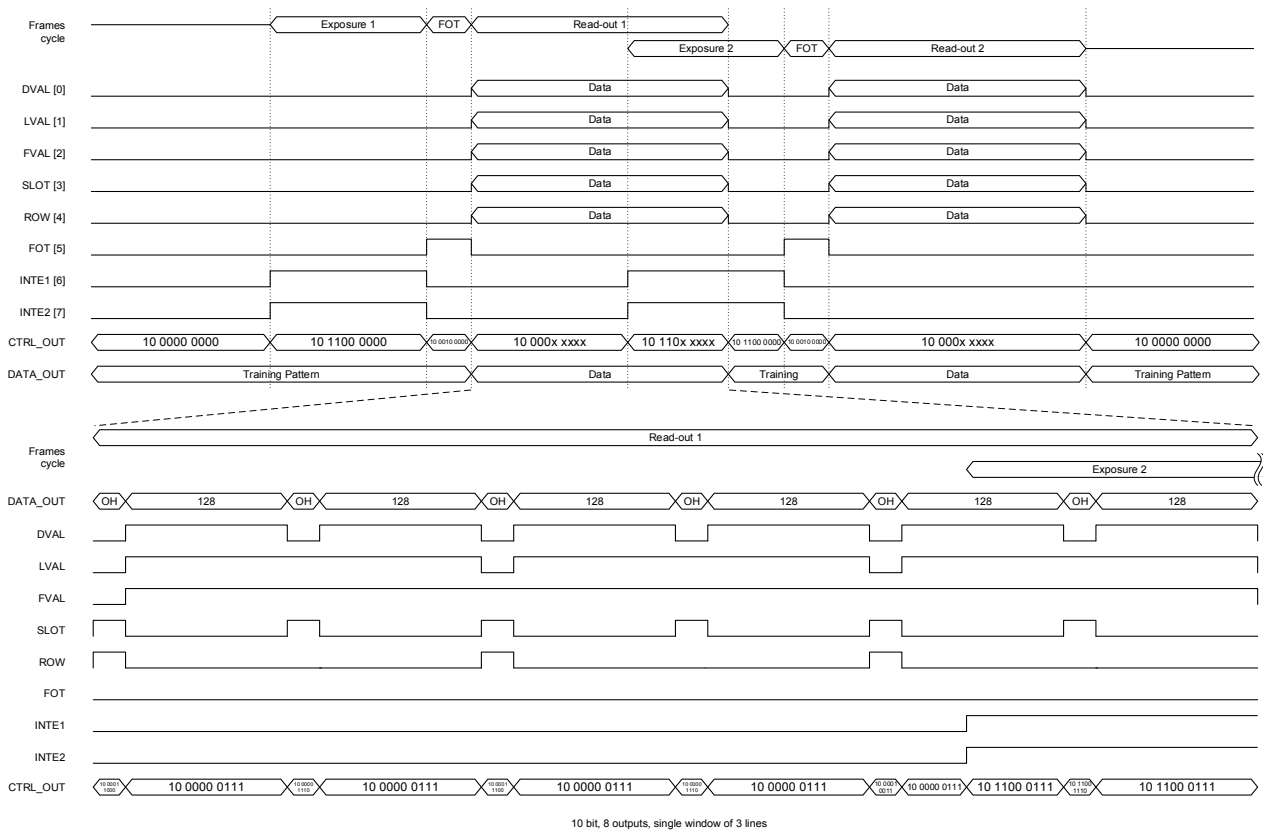

FIGURE 32: DETAILED TIMINGS OF THE CONTROL CHANNEL (8 OUTPUTS, 3 LINES WINDOW)

## 4.6 TRAINING DATA

To synchronize the receiving side with the LVDS outputs of the CMV2000, a known data pattern can be put on the output channels. This pattern can be used to “train” the LVDS receiver of the surrounding system to achieve correct word alignment of the image data. Such a training pattern is put on all 16 data channel outputs when there is no valid image data to be sent (so, also in between bursts of 128 pixels). The training pattern is a 10-bit or 12-bit data word that replaces the pixel data. The sensor has a 12-bit sequencer register (address 78-79) that can be loaded through the SPI to change the contents of the 12-bit training pattern.

The control channel does not send a training pattern, because it is used to send control information at all time. Word alignment can be done on this channel when the sensor is idle (not exposing or sending image data). In this case all bits of the control word are zero, except for bit [9] (= 0010 0000 0000 or 512 decimal).

Figure 33 shows the location of the training pattern (TP) on the data channels and control channels when the sensor is in idle mode and when a frame of 3 rows is read-out. The default mode of 16 outputs is selected.

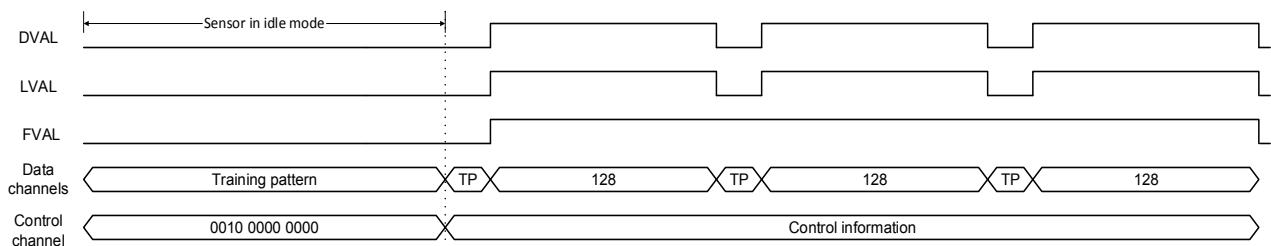

**FIGURE 33: TRAINING PATTERN LOCATION IN THE DATA AND CONTROL CHANNELS**

## 5 IMAGE SENSOR PROGRAMMING

This section explains how the CMV2000 can be programmed using the on-board sequencer registers.

### 5.1 EXPOSURE MODES

The exposure time can be programmed in two ways, externally or internally. Externally, the exposure time is defined as the time between the rising edge of T\_EXP1 and the rising edge of FRAME\_REQ (see Chapter 3.10.2 for more details). Internally, the exposure time is set by uploading the desired value to the corresponding sequencer register.

The table below gives an overview of the registers involved in the exposure mode.

Exposure time settings			
Register name	Register address	Default value	Description of the value
Exp_ext	41[0]	0	0: Use registers for defining integration time 1: Use external signals T_EXP1 and FRAME_REQ for integration control
Exp_time	42[7:0] 43[7:0] 44[7:0]	1088	<p>If Exp_ext = '0': Defines the exposure time according to the following formula:</p> $129 * clk\_per(0.43 * fot\_length + Exp\_time)$ <p>Where clk_per is the period of the CLK_IN input clock and fot_length is the value in register 73.</p> <p>If Exp_ext = '1': The exposure time is:</p> $129 * clk\_per(0.43 * fot\_length) + external\ exposure\ time$ <p>Where external exposure time is the time between the T_EXP1 and FRAME_REQ pulses.</p>

To calculate back from actual exposure time to the register value for internal exposure you can use the following formula (exposure time and clk\_per should have the same time unit):

$$Exp\_time = \frac{exposure\ time}{129 * clk\_per} - 0.43 * fot\_length$$

For very short integration times, the fot\_length should be lowered to 5 and the maximum clock speed should be used. In internal exposure mode, the shortest exposure time is limited by the exp\_time register, when this is set to 1, the shortest exposure time is 14.24µs, or 8.47µs for fot\_length = 5.

In external exposure mode, the time between T\_EXP1 and FRAME\_REQ can be as short as one clock cycle, reducing the shortest exposure time even more to 11.58µs, or 5.80µs for fot\_length = 5.

### 5.2 HIGH DYNAMIC RANGE MODES

The sensor has different ways to achieve high optical dynamic range in the grabbed image.

- Interleaved read-out: the odd and even rows have a different exposure time
- Piecewise linear response: pixels respond to light with a piecewise linear response curve.
- Multi-frame read-out: Different frames are read-out with increasing exposure time

All the HDR modes mentioned above can be used in both the internal and external exposure time mode.

### 5.2.1 INTERLEAVED READ-OUT

In this HDR mode, the odd and even rows of the image sensors will have a different exposure time. This mode can be enabled by setting the register in the table below.

HDR settings – interleaved read-out			
Register name	Register address	Default value	Description of the value
Exp_dual	41[1]	0	0: interleaved exposure mode disabled 1: interleaved exposure mode enabled

The surrounding system can combine the image of the odd rows with the image of the even rows which results in a high dynamic range image. In this image very bright and very dark objects are made visible without clipping. The table below gives an overview of the registers involved in the interleaved read-out when the internal exposure mode is selected.

HDR settings – interleaved read-out			
Register name	Register address	Default value	Description of the value
Exp_time	42[7:0] 43[7:0] 44[7:0]	1088	If Exp_dual = '1' Defines the exposure time for the even rows according following formula: $129 * clk\_per(0.43 * fot\_length + Exp\_time)$ Where clk_per is the period of the CLK_IN input clock.
Exp_time2	56[7:0] 57[7:0] 58[7:0]	1088	If Exp_dual = '1' Defines the exposure time for the odd rows according following formula: $129 * clk\_per(0.43 * fot\_length + Exp\_time2)$ Where clk_per is the period of the CLK_IN input clock.

When the external exposure mode and interleaved read-out are selected, the different exposure times are achieved by using the T\_EXP1 and T\_EXP2 input pins. T\_EXP1 defines the exposure time for the even lines, while T\_EXP2 defines the exposure time for the odd lines. See Figure 34 below for more details.

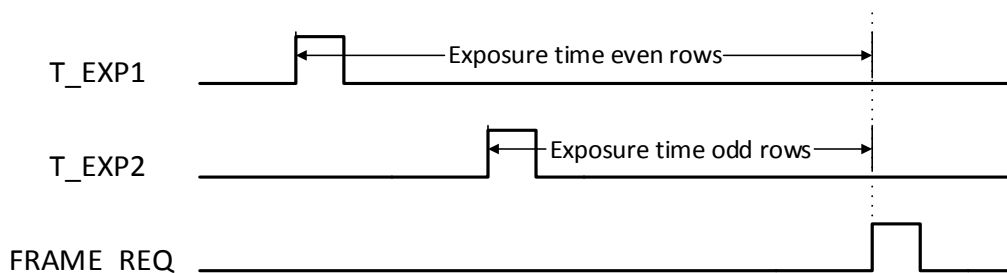

FIGURE 34: INTERLEAVED READ-OUT IN EXTERNAL EXPOSURE MODE

When a color sensor is used, the sequencer should be programmed to make sure it takes the Bayer pattern into account when doing interleaved read-out. This can be done by setting the appropriate register to '0'.

Color/mono			
Register name	Register address	Default value	Description of the value
mono	39[0]	1	0: color sensor is used 1: monochrome sensor is used

5.2.2 PIECEWISE LINEAR RESPONSE

The CMV2000 has the possibility to achieve a high optical dynamic range by using a piecewise linear response. This feature will clip illuminated pixels which reach a programmable voltage, while leaving the darker pixels untouched. The clipping level can be adjusted 2 times within one exposure time to achieve a maximum of 3 slopes in the response curve, as shown in Figure 35.

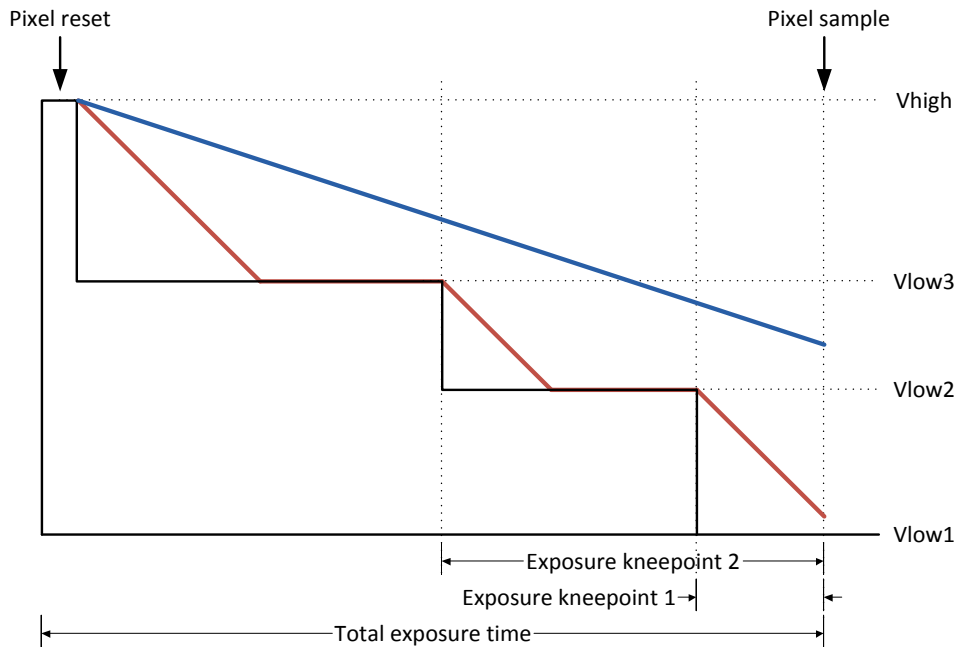

FIGURE 35: PIECEWISE LINEAR RESPONSE DETAILS

In Figure 35, the red lines represent a pixel on which a large amount of light is falling. The blue line represents a pixel on which less light is falling. The bright pixel is held to a programmable voltage for a programmable time during the exposure time. This happens two times to make sure that at the end of the exposure time the pixel is not saturated. The darker pixel is not influenced and will have a normal response. The Vlow voltages and different exposure times are programmable using the sequencer registers. Using this feature, a response as shown in Figure 36 can be achieved. The placement of the knee points on the X-axis is controlled by the Vlow programming, while the slope of the segments is controlled by the programmed exposure times.

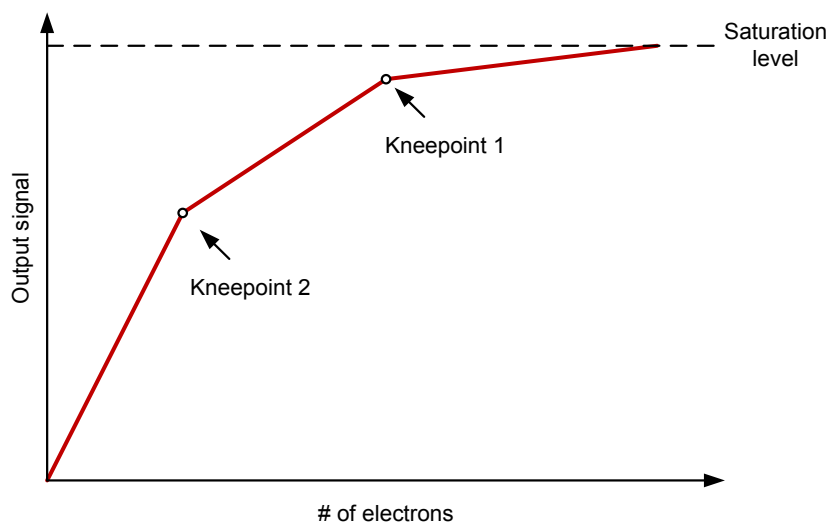

FIGURE 36: PIECEWISE LINEAR RESPONSE



### 5.2.2.1 PIECEWISE LINEAR RESPONSE WITH INTERNAL EXPOSURE MODE

The following registers need to be programmed when a piecewise linear response in internal exposure mode is desired.

HDR settings – multiple slope			
Register name	Register address	Default value	Description of the value
Exp_time	42[7:0] 43[7:0] 44[7:0]	1088	Defines the total exposure time according following formula:  $129 * clk\_per(0.43 * fot\_length + Exp\_time)$  Where <i>clk_per</i> is the period of the CLK_IN input clock.
Nr_slopes	54[1:0]	1	Defines the number of slopes (min=1, max=3).
Exp_kp1	48[7:0] 49[7:0] 50[7:0]	1	Defines the exposure time of kneepoint 1. Formula:  $129 * clk\_per(0.43 * fot\_length + Exp\_kp1)$  Where <i>clk_per</i> is the period of the CLK_IN input clock.
Exp_kp2	51[7:0] 52[7:0] 53[7:0]	1	Defines the exposure time of kneepoint 2. Formula:  $129 * clk\_per(0.43 * fot\_length + Exp\_kp2)$  Where <i>clk_per</i> is the period of the CLK_IN input clock.
Vlow3	90[6:0]	96	Defines the Vlow3 voltage (DAC setting). Bit [6] = enable Bit [5:0] = Vlow3 value
Vlow2	89[6:0]	96	Defines the Vlow2 voltage (DAC setting). Bit [6] = enable Bit [5:0] = Vlow2 value

### 5.2.2.2 PIECEWISE LINEAR RESPONSE WITH EXTERNAL EXPOSURE MODE

When external exposure time is used and a piecewise linear response is desired, the following registers should be programmed. Note that a combination of the piecewise linear response and interleaved read-out is not possible.

HDR settings – multiple slope			
Register name	Register address	Default value	Description of the value
Nr_slopes	54[1:0]	1	Defines the number of slopes (min=1, max=3).
Vlow3	90[6:0]	96	Defines the Vlow3 voltage (DAC setting).
Vlow2	89[6:0]	96	Defines the Vlow2 voltage (DAC setting).

The timing that needs to be applied in this external exposure mode looks like the one below.

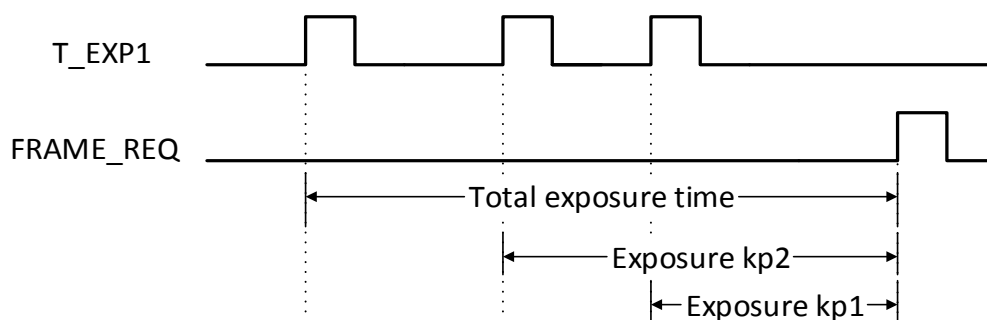

FIGURE 37: PIECEWISE LINEAR RESPONSE WITH EXTERNAL EXPOSURE TIME MODE

### 5.2.3 MULTI-FRAME READ-OUT

The sensor has the possibility to read-out multiple frames with increasing exposure time for each frame. The exposure time step and number of frames can be programmed using the appropriate registers. The frames grabbed in this mode, can be combined to create one high dynamic range image. This combination needs to be made by the receiving system.

The following registers should be used when this multi-frame read-out is selected. This mode only works with internal exposure time setting.

HDR settings – multi-frame read-out			
Register name	Register address	Default value	Description of the value
Exp_time	42[7:0] 43[7:0] 44[7:0]	1088	Defines the exposure time of the first frame in the sequence. Formula:  $129 * clk\_per(0.43 * fot\_length + Exp\_time)$ Where <i>clk_per</i> is the period of the CLK_IN input clock.
Exp_step	45[7:0] 46[7:0] 47[7:0]	0	Defines the step size for the increasing exposure times in multi-frame read-out. This value will be added to Exp_time per frame. So the exposure time for the n <sup>th</sup> frame is:  $129 * clk\_per(0.43 * fot\_length + Exp\_time + (n - 1) * Exp\_step)$ Where <i>clk_per</i> is the period of the CLK_IN input clock and <i>n</i> is the n <sup>th</sup> frame.
Exp_seq	55[7:0]	1	Defines the number of frames to be read-out in multi-frame mode (min = 1, max = 255).

### 5.3 WINDOWING

To limit the amount of data or to increase the frame rate of the sensor, windowing in Y direction is possible. The number of lines and start address can be set by programming the appropriate registers. The CMV2000 has the possibility to read-out multiple (max=8) predefined subwindows in one read-out cycle. The default mode is to read-out one window with the full frame size (2048x1088).

#### 5.3.1 SINGLE WINDOW

When a single window is read out, the start address and size can be uploaded in the corresponding registers. The default start address is 0 and the default size is 1088 (full frame).

Windowing – single window			
Register name	Register address	Default value	Description of the value
start1	3[7:0] 4[7:0]	0	Defines the start address of the window in Y (min=0, max=1087)
Number_lines	1[7:0] 2[7:0]	1088	Defines the number of lines read-out by the sensor (min=1, max=1088)

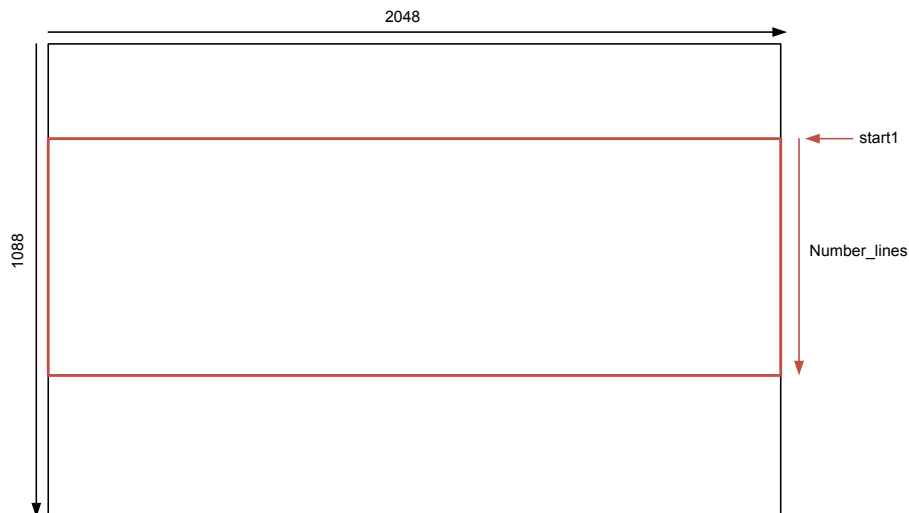

FIGURE 38: SINGLE WINDOW SETTINGS

#### 5.3.2 MULTIPLE WINDOWS

The CMV2000 can read out a maximum of 8 different subwindows in one read-out cycle. The location and length of these subwindows must be programmed in the correct registers. The total number of lines to be read-out (sum of all windows) needs to be specified in the Number\_lines register. The registers which need to be programmed for the multiple windows can be found in the table below. The default values will result in one window with 1088 lines to be read out.

Windowing – multiple windows			
Register name	Register address	Default value	Description of the value
Number_lines	1[7:0] 2[7:0]	1088	Defines the total number of lines read-out by the sensor (min=1, max=1088)
start1	3[7:0] 4[7:0]	0	Defines the start address of the first window in Y (min=0, max=1087)
Number_lines1	19[7:0] 20[7:0]	0	Defines the number of lines of the first window (min=1, max=1088)
start2	5[7:0] 6[7:0]	0	Defines the start address of the second window in Y (min=0, max=1087)

Windowing – multiple windows			
Register name	Register address	Default value	Description of the value
Number_lines2	21[7:0] 22[7:0]	0	Defines the number of lines of the second window (min=1, max=1088)
start3	7[7:0] 8[7:0]	0	Defines the start address of the third window in Y (min=0, max=1087)
Number_lines3	23[7:0] 24[7:0]	0	Defines the number of lines of the third window (min=1, max=1088)
start4	9[7:0] 10[7:0]	0	Defines the start address of the fourth window in Y (min=0, max=1087)
Number_lines4	25[7:0] 26[7:0]	0	Defines the number of lines of the fourth window (min=1, max=1088)
start5	11[7:0] 12[7:0]	0	Defines the start address of the fifth window in Y (min=0, max=1087)
Number_lines5	27[7:0] 28[7:0]	0	Defines the number of lines of the fifth window (min=1, max=1088)
start6	13[7:0] 14[7:0]	0	Defines the start address of the sixth window in Y (min=0, max=1087)
Number_lines6	29[7:0] 30[7:0]	0	Defines the number of lines of the sixth window (min=1, max=1088)
start7	15[7:0] 16[7:0]	0	Defines the start address of the seventh window in Y (min=0, max=1087)
Number_lines7	31[7:0] 32[7:0]	0	Defines the number of lines of the seventh window (min=1, max=1088)
start8	17[7:0] 18[7:0]	0	Defines the start address of the eighth window in Y (min=0, max=1087)
Number_lines8	33[7:0] 34[7:0]	0	Defines the number of lines of the eighth window (min=1, max=1088)



FIGURE 39: EXAMPLE OF 4 MULTIPLE FRAMES READ-OUT

## 5.4 IMAGE FLIPPING

The image coming out of the image sensor can be flipped in X (per channel) and/or Y direction. When no flipping is enabled, the pixel in the upper left corner of the screen - (pixel (0,0) - is read out first. When flipping in Y is enabled, the bottom left pixel (0,1087) is read out first instead of the top left pixel (0,0). When flipping in X is enabled, only the pixels within a channel are mirrored, not the channels themselves. Therefore, the first row in channel 1 to be read out is pixel (1023,0) to pixel (0,0). In channel 2, this is pixel (2047,0) to pixel (1024,0).

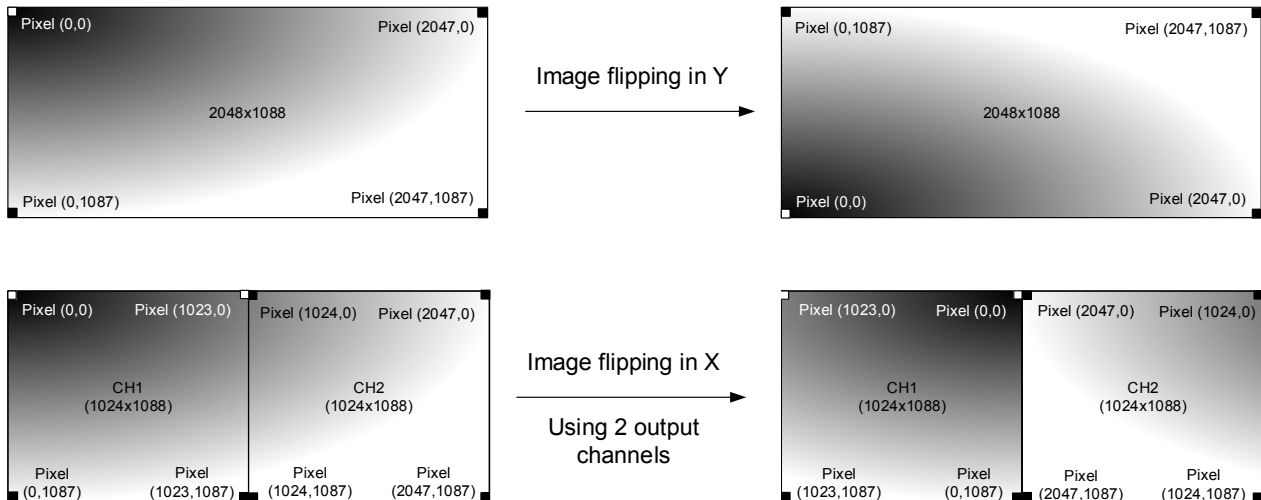

FIGURE 40: IMAGE FLIPPING

Image flipping			
Register name	Register address	Default value	Description of the value
Image_flipping	40[1:0]	0	0: No image flipping 1: Image flipping in X 2: Image flipping in Y 3: Image flipping in X and Y

## 5.5 IMAGE SUBSAMPLING

To maintain the same field of view but reduce the amount of data coming out of the sensor, a subsampling mode is implemented on the chip. Different subsampling schemes can be programmed by setting the appropriate registers. These subsampling schemes can take into account whether a color or monochrome sensor is used to preserve the Bayer pattern information. The registers involved in subsampling are detailed below. A distinction is made between a simple and advanced mode (can be used for color devices). Subsampling can be enabled in every windowing mode.

### 5.5.1 SIMPLE SUBSAMPLING

Image subsampling - simple			
Register name	Register address	Default value	Description of the value
Number_lines	1[7:0] 2[7:0]	1088	Defines the total number of lines read-out by the sensor (min=1, max=1088)
Sub_s	35[7:0] 36[7:0]	0	Number of rows to skip (min=0, max=1086)
Sub_a	37[7:0] 38[7:0]	0	Identical to Sub_s

Figure 41 below give two subsampling examples (skip 4x and skip 1x).

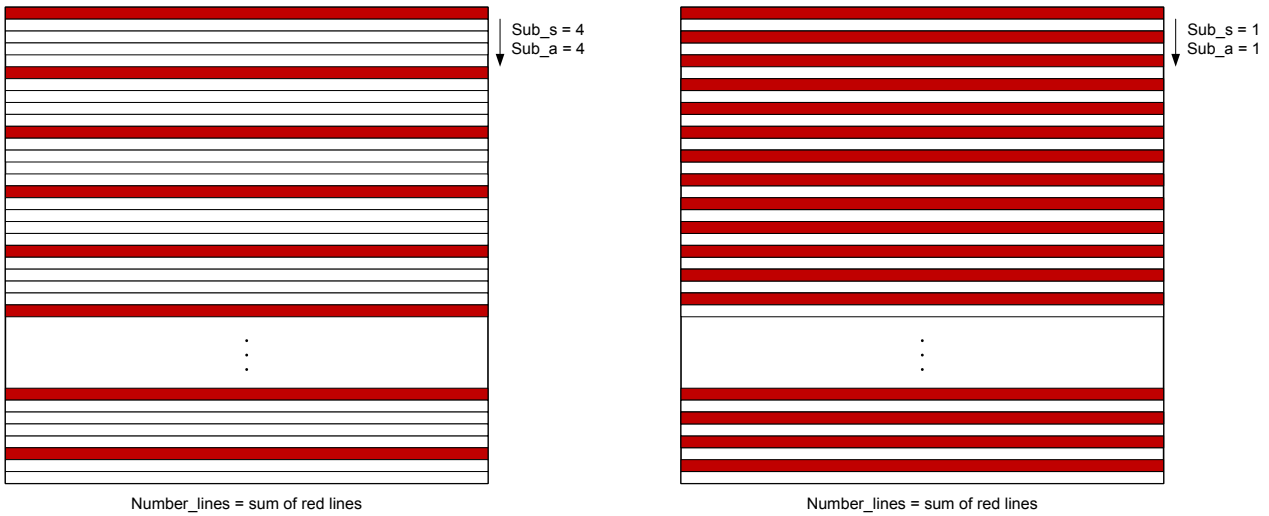

**FIGURE 41: SUBSAMPLING EXAMPLES (SKIP 4X AND SKIP 1X)**

**5.5.2 ADVANCED SUBSAMPLING**

When a color sensor is used, the subsampling scheme should take into account that a Bayer color filter is applied on the sensor. This Bayer pattern should be preserved when subsampling is used. This means that the number of rows to be skipped should always be a multiple of two. An advanced subsampling scheme can be programmed to achieve these requirements. Of course, this advanced subsampling scheme can also be programmed in a monochrome sensor. See the table of registers below for more details.

Image subsampling - advanced			
Register name	Register address	Default value	Description of the value
Number_lines	1[7:0] 2[7:0]	1088	Defines the total number of lines read-out by the sensor (min=1, max=1088)
Sub_s	35[7:0] 36[7:0]	0	Should be '0' at all times
Sub_a	37[7:0] 38[7:0]	0	Number of rows to skip, it should be an even number between (0 and 1086).

Figure 42 below give two subsampling examples (skip 4x and skip 2x) in advanced mode.

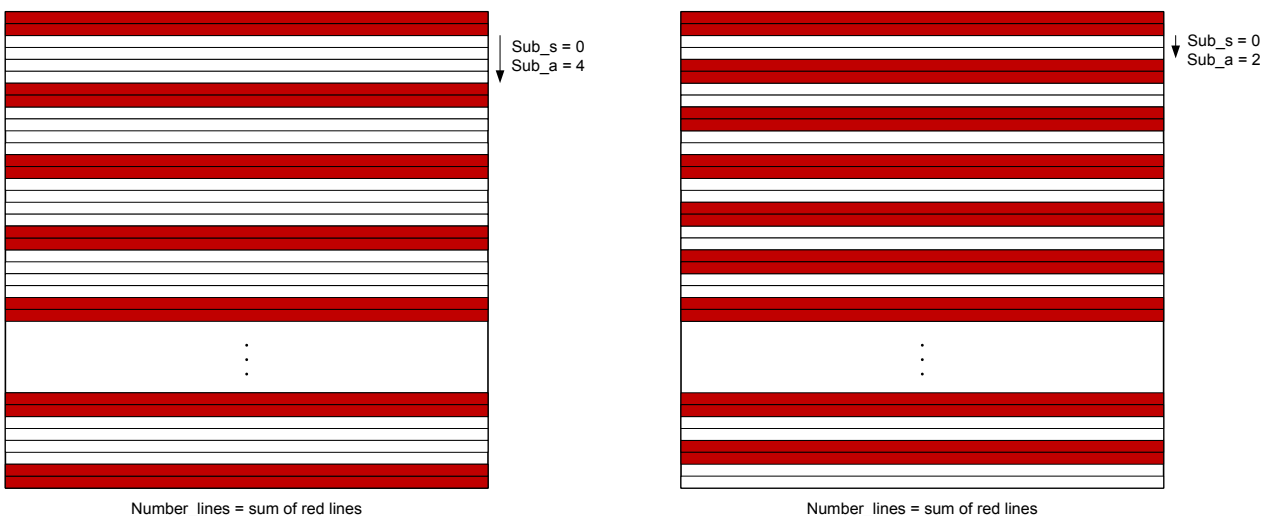

**FIGURE 42: SUBSAMPLING EXAMPLES IN ADVANCED MODE (SKIP 4X AND SKIP 2X)**

## 5.6 NUMBER OF FRAMES

When internal exposure mode is selected, the number of frames sent by the sensor after a frame request can be programmed in the corresponding sequencer register.

Number of frames			
Register name	Register address	Default value	Description of the value
Number_frames	70[7:0] 71[7:0]	1	Defines the number of frames grabbed and sent by the image sensor in internal exposure mode (min =1, max = 65535)

## 5.7 OUTPUT MODE

The number of LVDS channels can be selected by programming the appropriate sequencer register. The pixel remapping scheme and the read-out timing for each mode can be found in Chapter 4 of this document.

Output mode			
Register name	Register address	Default value	Description of the value
Output_mode	72[1:0]	0	0: 16 outputs 1: 8 outputs 2: 4 outputs 3: 2 outputs

## 5.8 TRAINING PATTERN

As detailed in Chapter 4.6, a training pattern is sent over the LVDS data channels whenever no valid image data is sent. This training pattern can be programmed using the sequencer register.

Training pattern			
Register name	Register address	Default value	Description of the value
Training_pattern	78[7:0] 79[3:0]	85	The 12 LSBs of this 16 bit word are sent in 12-bit mode. In 10 bit mode the 10 LSBs are sent.

## 5.9 10-BIT OR 12-BIT MODE

The CMV2000 has the possibility to send 12 bits or 10 bits per pixel. The end user can select the desired resolution by programming the corresponding sequencer register.

10-bit or 12-bit mode			
Register name	Register address	Default value	Description of the value
Bit_mode	111[0]	1	0: 12 bits per pixel 1: 10 bits per pixel
ADC_Resolution	112[1:0]	0	0: 10 bits per pixel 1: 11 bits per pixel 2: 12 bits per pixel

## 5.10 DATA RATE

During start-up or after a sequencer reset, the data rate can be changed if a lower speed than 480Mbps is desired. This can be done by lowering the speed of the input clocks CLK\_IN and LVDS\_CLK. See Chapter 3.5 for more details on the input clocks. See Chapter 3.6 for details on how the data rate can be changed. No registers have to be changed when using a data rate different from 480Mbps.

## 5.11 POWER CONTROL

The power consumption of the CMV2000 can be regulated by disabling the LVDS data channels when they are not used (in 8, 4 or 2 outputs mode). The power will decrease with approximately 18mW per channel. So reducing the outputs from 16 to 4 will save you about 216mW or 33%. This is the main source for power saving.

10-bit or 12-bit mode			
Register name	Register address	Default value	Description of the value
Channel_en	80[7:0] 81[7:0] 82[2:0]	All '1'	Bit 0-15 enable/disable the data output channels Bit 16 enables/disables the clock channel Bit 17 enables/disables the control channel Bit 18 enables/disables the clock input 0: disabled 1: enabled

Decreasing the CLK\_IN frequency and the LVDS\_CLK frequency will also decrease power consumption a little. Decreasing the LVDS\_CLK frequency from 480MHz to 128MHz will decrease power consumption with about 25mW. All power savings will happen on the VDD20 supply. Other settings or factors have little to no effect on the power consumption.

## 5.12 OFFSET AND GAIN

### 5.12.1 OFFSET

A digital offset can be applied to the output signal. This dark level offset can be programmed by setting the desired value in the sequencer register. The 14 bit register value is a 2-complement number, allowing us to have a positive and a negative offset (from 8191 to -8192). The ADC itself has a fixed offset of 70.

So the dark-level @ output = 70 + Offset (in 2's complement). For example register value 16323 (11 1111 1100 0011) equals -61 in 2's complement. The default dark-level is thus set at 70 - 61 = 9 digital numbers.

Offset																														
Register name	Register address	Default value	Description of the value																											
Offset	100[7:0] 101[5:0]	16323	Defines the dark level offset applied to the output signal (min = 0, max = 16383).  The value is in 2's complement: <table border="1" style="margin-left: 40px;"> <thead> <tr> <th>Decimal</th> <th>Binary</th> <th>2's Comp.</th> </tr> </thead> <tbody> <tr> <td>0</td> <td>00 0000 0000 0000</td> <td>0</td> </tr> <tr> <td>1</td> <td>00 0000 0000 0001</td> <td>1</td> </tr> <tr> <td>...</td> <td>...</td> <td>...</td> </tr> <tr> <td>8191</td> <td>01 1111 1111 1111</td> <td>8191</td> </tr> <tr> <td>8192</td> <td>10 0000 0000 0000</td> <td>-8192</td> </tr> <tr> <td>8193</td> <td>10 0000 0000 0001</td> <td>-8191</td> </tr> <tr> <td>...</td> <td>...</td> <td>...</td> </tr> <tr> <td>16383</td> <td>11 1111 1111 1111</td> <td>-1</td> </tr> </tbody> </table>	Decimal	Binary	2's Comp.	0	00 0000 0000 0000	0	1	00 0000 0000 0001	1	...	...	...	8191	01 1111 1111 1111	8191	8192	10 0000 0000 0000	-8192	8193	10 0000 0000 0001	-8191	...	...	...	16383	11 1111 1111 1111	-1
Decimal	Binary	2's Comp.																												
0	00 0000 0000 0000	0																												
1	00 0000 0000 0001	1																												
...	...	...																												
8191	01 1111 1111 1111	8191																												
8192	10 0000 0000 0000	-8192																												
8193	10 0000 0000 0001	-8191																												
...	...	...																												
16383	11 1111 1111 1111	-1																												



### 5.12.2 GAIN

An analog gain and ADC gain can be applied to the output signal. The analog gain is applied by a PGA in every column. The digital gain is applied by the ADC.

Gain			
Register name	Register address	Default value	Description of the value
PGA	102[1:0]	0	0: x1 gain 1: x1.2 gain 2: x1.4 gain 3: x1.6 gain
ADC_gain	103[7:0]	32	Defines the slope of the ADC ramp, a higher value equals more gain.

The ADC gain is dependent on the CLK\_IN frequency. A slower clock signal means a higher ADC\_gain register value for an actual ADC gain of 1x. Also at higher register values, the actual ADC gain will increase in bigger steps. So fine-tuning the ADC gain is easier at lower register values. Below you can find a typical graph regarding these settings.

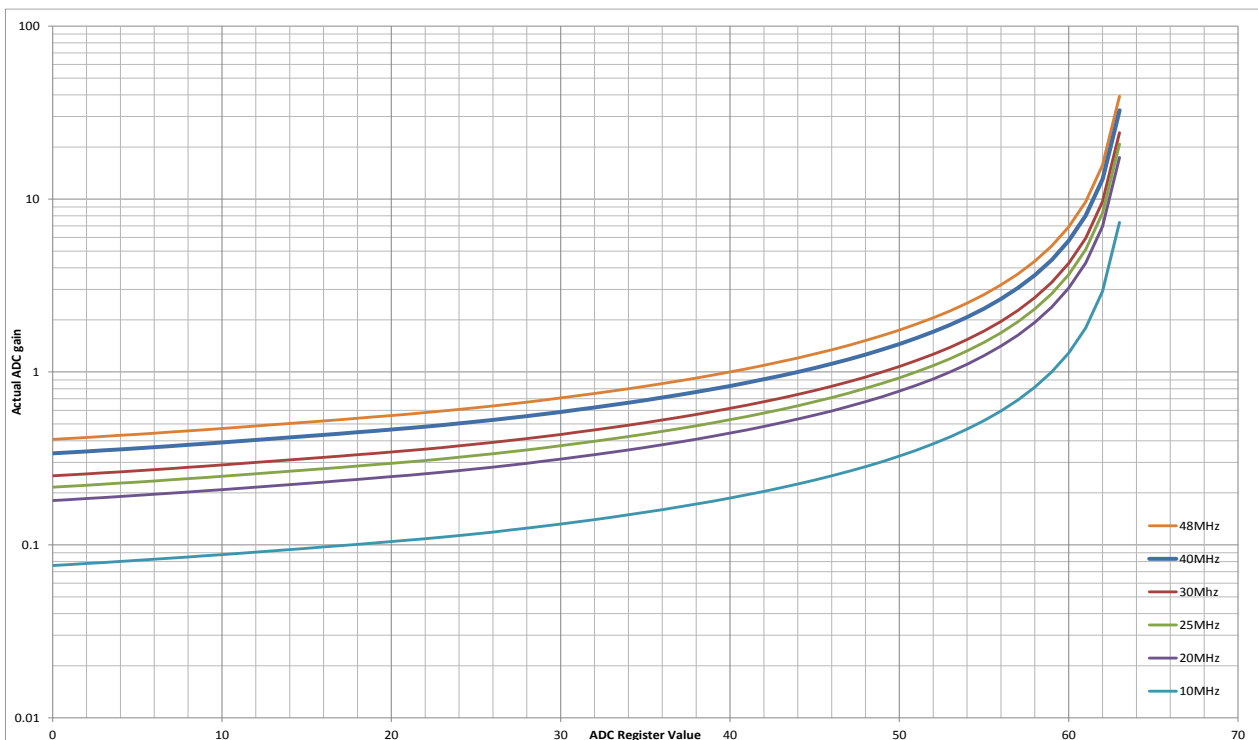

**FIGURE 43: ACTUAL ADC GAIN VS. ADC REGISTER VALUE [103]**

## 5.13 RECOMMENDED REGISTER SETTINGS

The following table gives an overview of the registers which have a required value which is different from their default start-up value. We strongly recommend to load these register settings after start-up and before grabbing an image.

Address	Name	Required Value
82[2:0]	Channel_en	7
84[3:0]	i_col	4
85[3:0]	i_col_prech	1
88[6:0]	v_tglow1	64
91[6:0]	Vres_low	64
94[6:0]	V_precharge	101
95[6:0]	V_ref	106
115[0]	Config2	1
117[0]	Config1	1

### 5.13.1 ADJUSTING REGISTERS FOR OPTIMAL PERFORMANCE

Due to processing differences, the response and optical performance may differ slightly from sensor to sensor. To adjust this difference in response, the following registers should be tuned from sensor to sensor.

Address	Name	Default Value	Valid Range
103[7:0]	ADC_GAIN	32	40 - 55
98[6:0]	V_ramp1	96	102 - 115
99[6:0]	V_ramp2	96	102 - 115
100[7:0]	Offset	16323	0 - 16383
101[5:0]			

To optimize the sensor response and minimize noise, the following procedure should be followed for each sensor:

1. Start by programming all registers with the recommended values from the datasheet.
2. Take fully dark images with short exposure and calibrate the offset register so no pixel clips in black (< 0DN).
3. When column non-uniformities are observed in the dark image, a calibration of the V\_ramp1 and V\_ramp2 registers is necessary. These registers set the starting voltage of the ramp used by the column ramp ADC, so adjusting this value will improve column CDS (correlated double sampling) which will reduce the column FPN. Both values should be adjusted together and should always have the same value.
4. Now take images with light and normal exposure. If the image isn't saturated increase the light or the exposure time until all pixels reach a constant value. If not all pixels saturate at 1023 (meaning that the non-linear part of the pixel voltage is in the ADC input range), increase the ADC gain/range setting until they do. The PGA amplifier can also be used at this stage.
5. The dark offset level may have shifted when doing ADC calibration, so repeat step 2.
6. To compensate gain differences between sensors, choose a fixed light setting or exposure time at which the sensor shows a grey image about 50% of its swing (512 at 10bit). Now tweak the ADC setting per sensor so that all sensors will have the same average grey value of about 512. This way all sensors will behave about the same to the same amount of light.

## 6 REGISTER OVERVIEW

The table below gives an overview of all the sensor registers. The registers with the remark “Do not change” should not be changed unless advised in Chapter 5.

Register overview										
Address	Default	Value								Remarks
		bit[7]	bit[6]	bit[5]	bit[4]	bit[3]	bit[2]	bit[1]	bit[0]	
0	0									Do not change
1	64	Number_lines[7:0]								
2	4	Number_lines [15:8]								
3	0	Start1[7:0]								
4	0	Start1[15:8]								
5	0	Start2[7:0]								
6	0	Start2[15:8]								
7	0	Start3[7:0]								
8	0	Start3[15:8]								
9	0	Start4[7:0]								
10	0	Start4[15:8]								
11	0	Start5[7:0]								
12	0	Start5[15:8]								
13	0	Start6[7:0]								
14	0	Start6[15:8]								
15	0	Start7[7:0]								
16	0	Start7[15:8]								
17	0	Start8[7:0]								
18	0	Start8[15:8]								
19	0	Number_lines1[7:0]								
20	0	Number_lines1[15:8]								
21	0	Number_lines2[7:0]								
22	0	Number_lines2[15:8]								
23	0	Number_lines3[7:0]								
24	0	Number_lines3[15:8]								
25	0	Number_lines4[7:0]								
26	0	Number_lines4[15:8]								
27	0	Number_lines5[7:0]								
28	0	Number_lines5[15:8]								
29	0	Number_lines6[7:0]								
30	0	Number_lines6[15:8]								
31	0	Number_lines7[7:0]								
32	0	Number_lines7[15:8]								
33	0	Number_lines8[7:0]								
34	0	Number_lines8[15:8]								
35	0	Sub_s[7:0]								
36	0	Sub_s[15:8]								
37	0	Sub_a[7:0]								
38	0	Sub_a[15:8]								
39	1								mono	
40	0								Image_flipping [1:0]	
41	0								Exp_ dual	Exp_ ext
42	64	Exp_time[7:0]								
43	4	Exp_time[15:8]								
44	0	Exp_time[23:16]								

Register overview										
Address	Default	Value								Remarks
		bit[7]	bit[6]	bit[5]	bit[4]	bit[3]	bit[2]	bit[1]	bit[0]	
45	0	Exp_step[7:0]								
46	0	Exp_step[15:8]								
47	0	Exp_step[23:16]								
48	1	Exp_kp1[7:0]								
49	0	Exp_kp1[15:8]								
50	0	Exp_kp1[23:16]								
51	1	Exp_kp2[7:0]								
52	0	Exp_kp2[15:8]								
53	0	Exp_kp2[23:16]								
54	1							Nr_slopes[1:0]		
55	1	Exp_seq[7:0]								
56	64	Exp_time2[7:0]								
57	4	Exp_time2[15:8]								
58	0	Exp_time2[23:16]								
59	0	Exp_step2[7:0]								
60	0	Exp_step2[15:8]								
61	0	Exp_step2[23:16]								
62	1									Do not change
63	0									Do not change
64	0									Do not change
65	1									Do not change
66	0									Do not change
67	0									Do not change
68	1									Do not change
69	1	Exp2_seq[7:0]								
70	1	Number_frames [7:0]								
71	0	Number_frames[15:8]								
72	0							Output_mode [1:0]		
73	10	fot_length[7:0]								Can be lowered to 5, see Chapter 5.1
74	8									Do not change
75	8									Do not change
76	8									Do not change
77	0									Do not change
78	85	Training_pattern[7:0]								
79	0							Training pattern [11:8]		
80	255	Channel_en[7:0]								
81	255	Channel_en[15:8]								
82	3							Channel_en [18:16]	Set to 7	
83	8							i_lvds[3:0]	Can be lowered to 4 for meeting EMC standards	
84	8							i_col[3:0]	Set to 4	
85	8							i_col_prech[3:0]	Set to 1	
86	8									Do not change
87	8									Do not change
88	96							Vtf_l1[6:0]	Set to 64	
89	96							Vlow2[6:0]		
90	96							Vlow3[6:0]		
91	96							Vres_low[6:0]	Set to 64	
92	96									Do not change

Register overview										
Address	Default	Value								Remarks
		bit[7]	bit[6]	bit[5]	bit[4]	bit[3]	bit[2]	bit[1]	bit[0]	
93	96									Do not change
94	96	V_precharge[6:0]								Set to 101
95	96	V_ref[6:0]								Set to 106
96	96									Do not change
97	96									Do not change
98	96	V_ramp1[6:0]								See 5.13.1
99	96	V_ramp2[6:0]								See 5.13.1
100	195	Offset[7:0]								See 5.13.1
101	63	Offset[13:8]								See 5.13.1
102	0								PGA[1:0]	
103	32	ADC_gain[7:0]								See 5.13.1
104	8									Do not change
105	8									Do not change
106	8									Do not change
107	8									Do not change
108	0								T_dig1[3:0]	
109	1								T_dig2[3:0]	
110	0									Do not change
111	1								bit_mode	
112	0								ADC_resolution [1:0]	
113	1									Do not change
114	0									Do not change
115	0								Config2	Set to 1
116	32									Do not change
117	8								Config1	Set to 1
118	0									Do not change
119	0									Do not change
120	0									Do not change
121	0									Do not change
122	0									Do not change
123	0									Do not change
124	0									Do not change
125	32									Do not change
126	0	Temp[7:0]								
127	0	Temp[15:8]								

Note: Register 125 can be used to verify which sensor is used.

Reg 125 value	Sensor type
32	CMV2000 v2
35	CMV2000 v3
64	CMV4000 v2
67	CMV4000 v3

## 7 MECHANICAL SPECIFICATIONS

### 7.1 PACKAGE DRAWING

#### 7.1.1 95 PINS $\mu$ PGA AND LGA

All dimensions are in millimeter. The LGA package (SMD) is identical to the  $\mu$ PGA but without the through-hole pins.

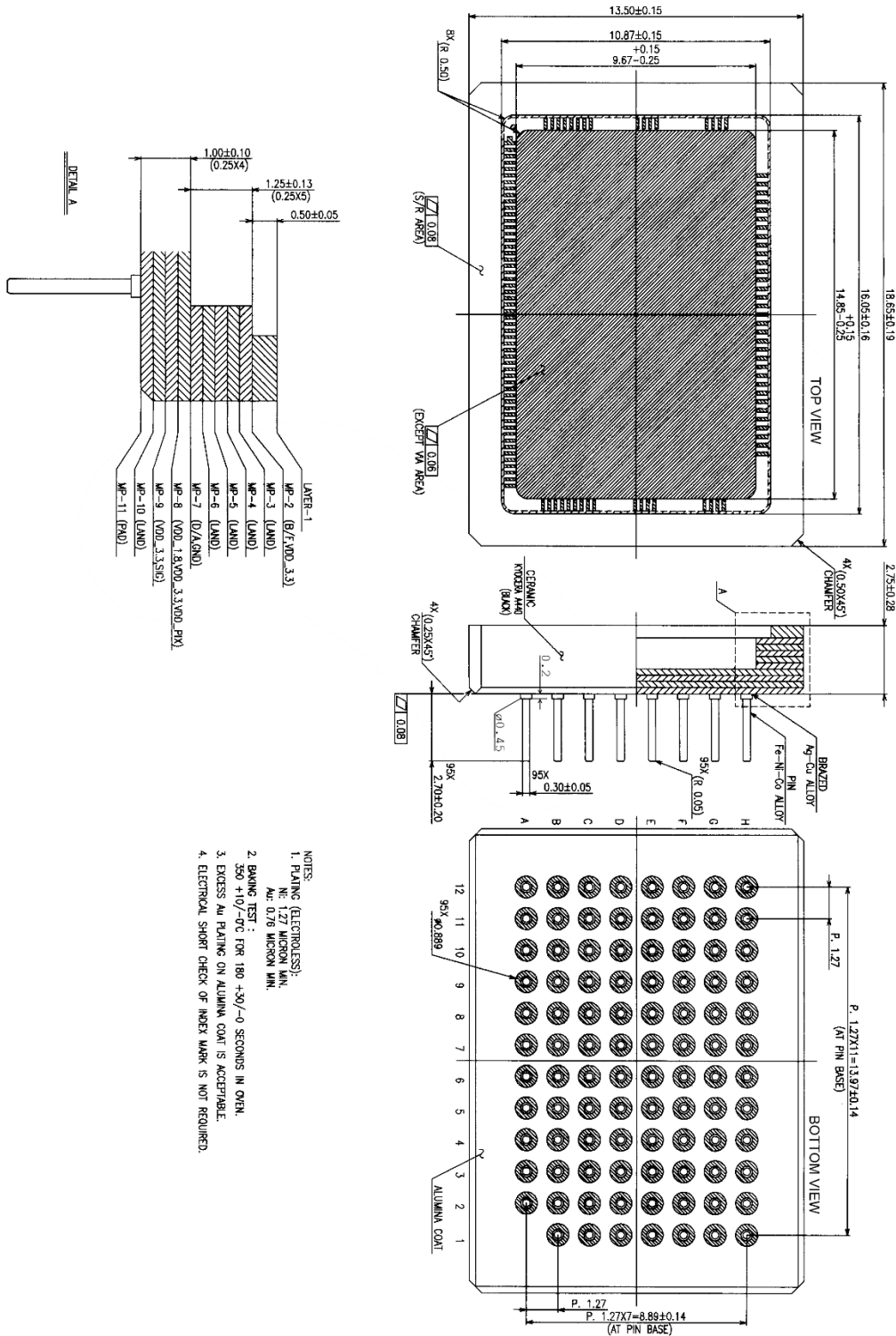
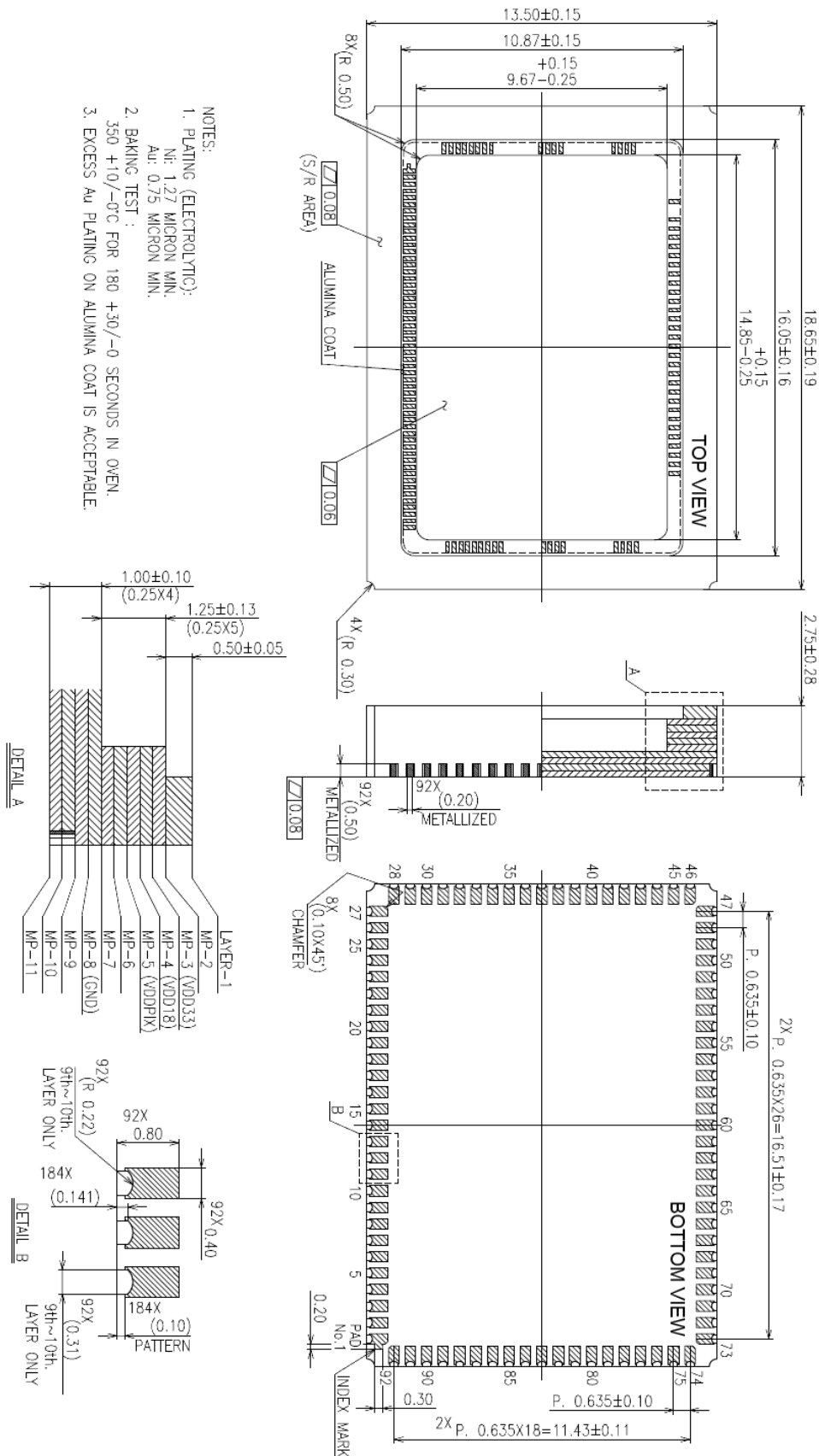

FIGURE 44:  $\mu$ PGA PACKAGE DRAWING

**7.1.2 92 PINS LCC**

All dimensions are in millimeter.



**FIGURE 45: LCC PACKAGE DRAWING**

## 7.2 ASSEMBLY DRAWING

The dimensions here below are the same for both packages. All dimensions are in millimeter.

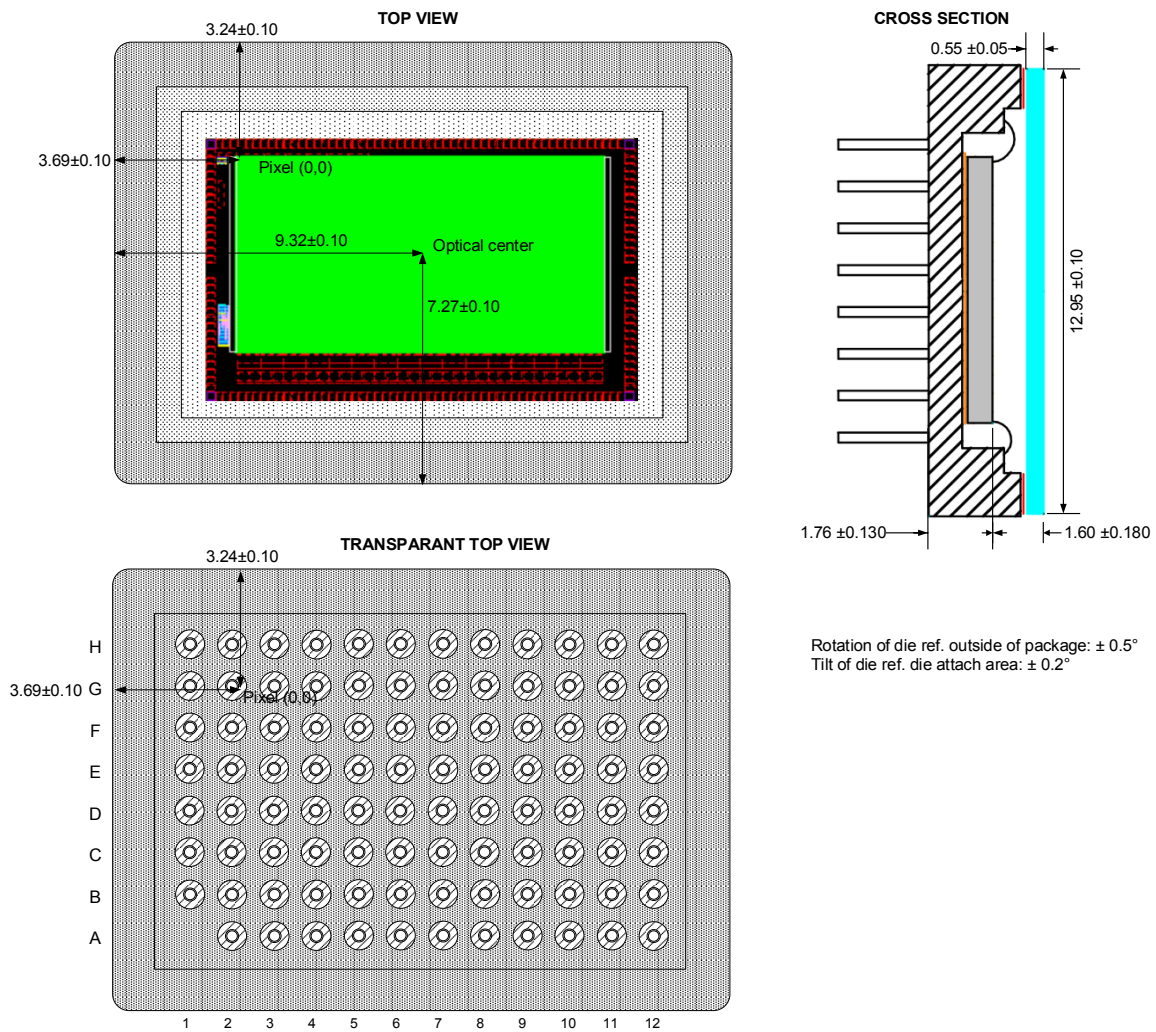

FIGURE 46: ASSEMBLY DRAWING



### 7.3 COVER GLASS

The cover glass of the CMV2000 is plain D263 glass with a transmittance as shown in Figure 47. Refraction index of the glass is 1.52.

When a color sensor is used an IR-cutoff filter should be placed in the optical path of the sensor.

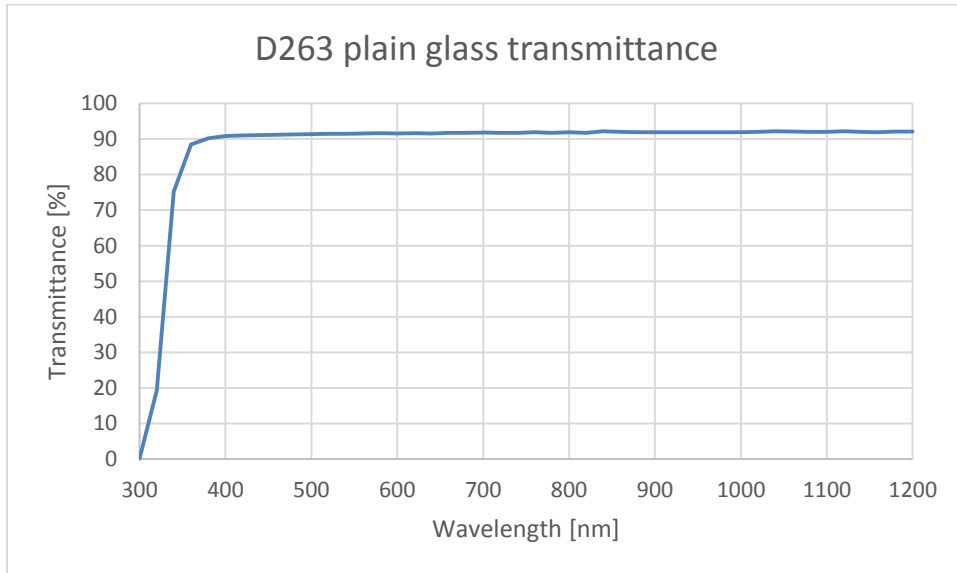

**FIGURE 47: TRANSMITTANCE CURVE FOR D263 COVER GLASS**

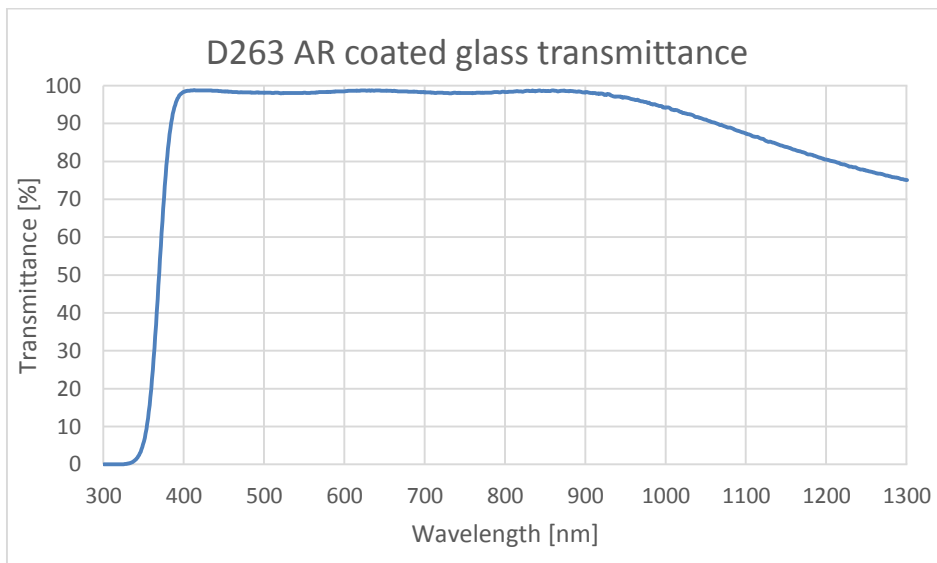

**FIGURE 48 TRANSMITTANCE CURVE FOR D263 AR COATED GLASS**

### 7.4 COLOR FILTERS

When a color version of the CMV2000 is used, the color filters are applied in a Bayer pattern. The color version of the CMV2000 always has microlenses. The typical spectral response of the CMV with color filters and D263 cover glass can be found below. The use of an IR cut-off filter in the optical path of the CMV2000 image sensor is necessary to obtain good color separation when using light with an NIR component.

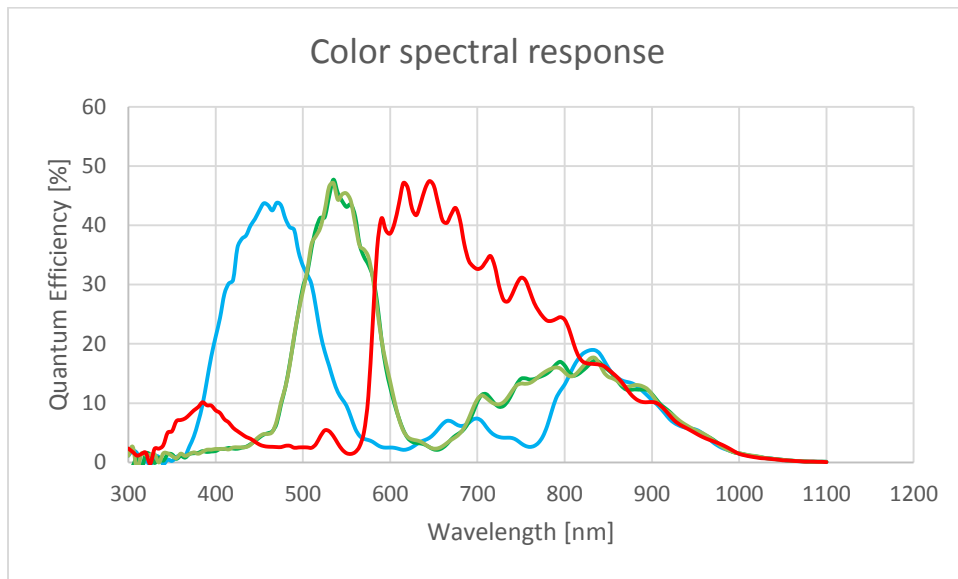

**FIGURE 49: TYPICAL SPECTRAL RESPONSE OF CMV2000 WITH RGB COLOR FILTERS AND D263 COVER GLASS**

An RGB Bayer pattern is used on the CMV2000 image sensor. The order of the RGB filter can be found in the drawing below. With Y-flipping off (reg40 = 0), pixel (0,0) at the top left is read out first and has a red filter. When Y-flipping is on, pixel (0,1087) is read out first and has a green filter. For X-flipping the address of the first pixel depends on the output channels used.

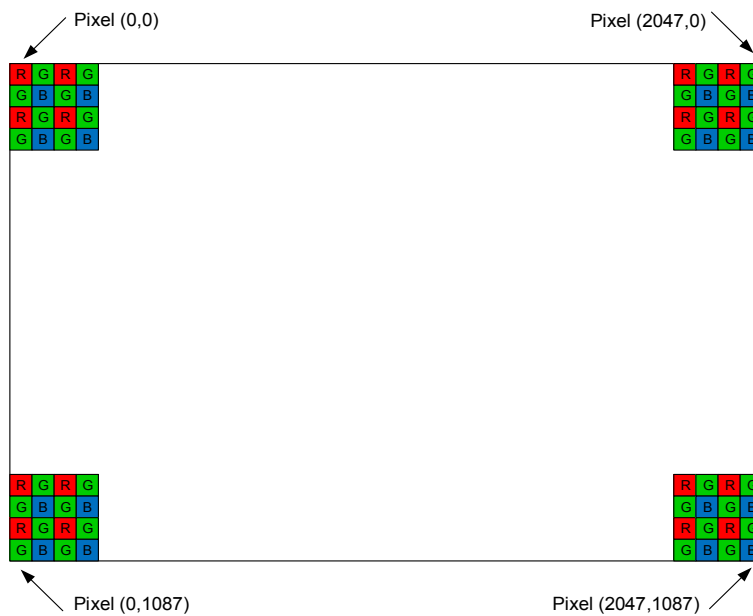

**FIGURE 50: RGB BAYER PATTERN ORDER**

## 8 RESPONSE CURVE

Below you can see a typical response curve of integration time (or light input) versus the average output value of the sensor.

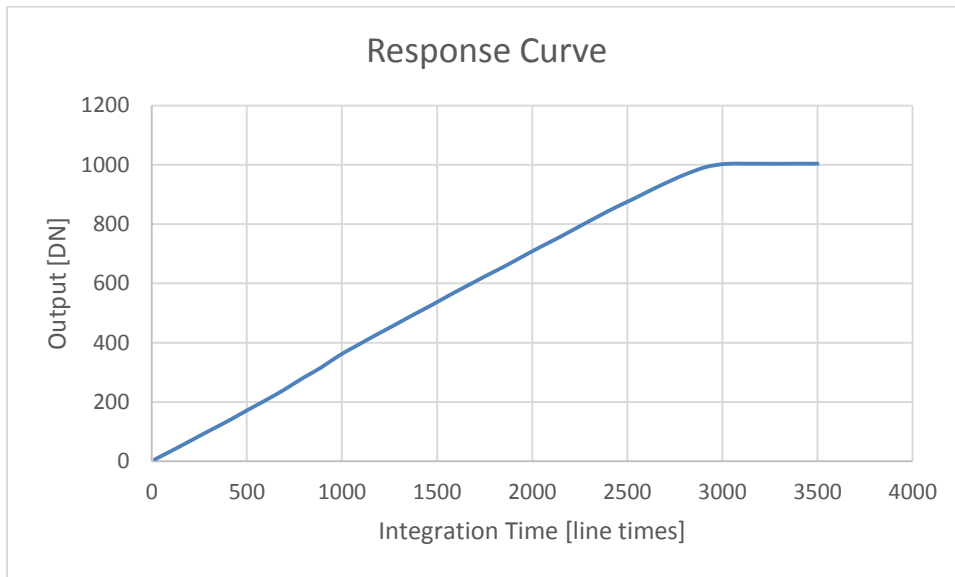

**FIGURE 51: TYPICAL RESPONSE CURVE**

## 9 SPECTRAL RESPONSE

### 9.1 5 $\mu$ M EPI DEVICES

The typical spectral response of a monochrome CMV2000 with microlenses can be found below.

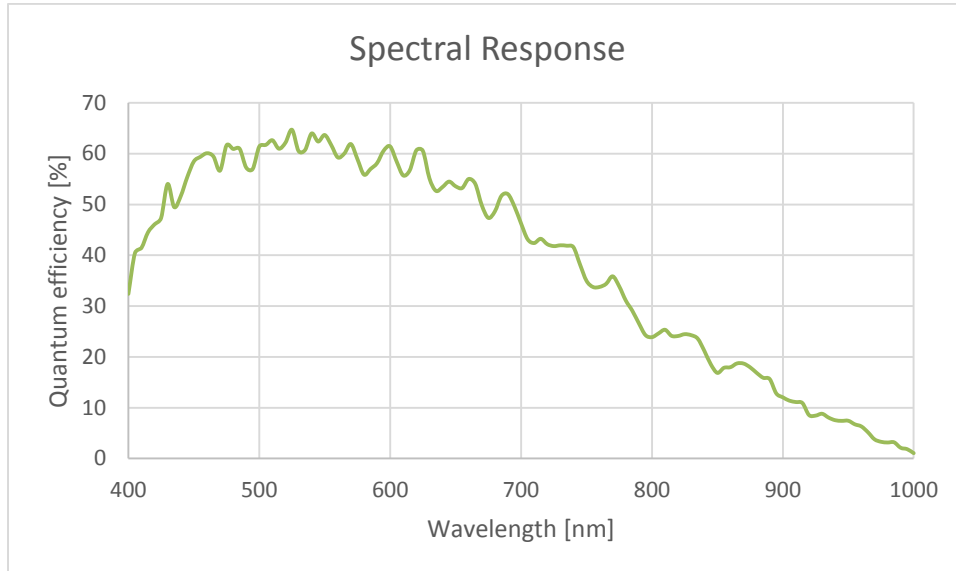

FIGURE 52: TYPICAL SPECTRAL RESPONSE OF THE CMV2000

### 9.2 12 $\mu$ M EPI DEVICES

A variation from the standard CMV2000 image sensors is processed on 12  $\mu$ m epitaxial (E12) Si wafers. The thicker epi-layer wafer starting material increases significantly the QE for wavelengths above 600 nm. Around 900 nm the QE is about doubled and increases from 8% to 16%.

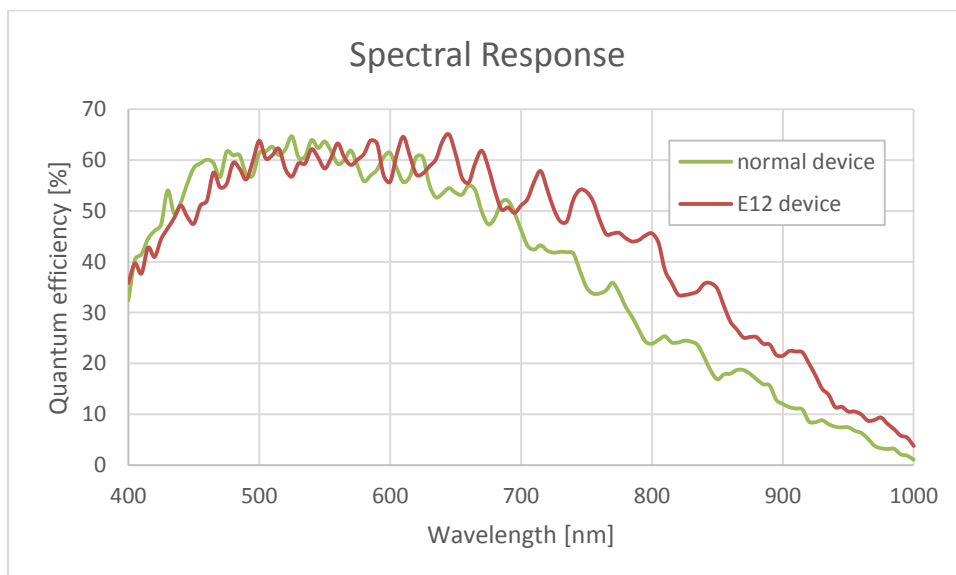
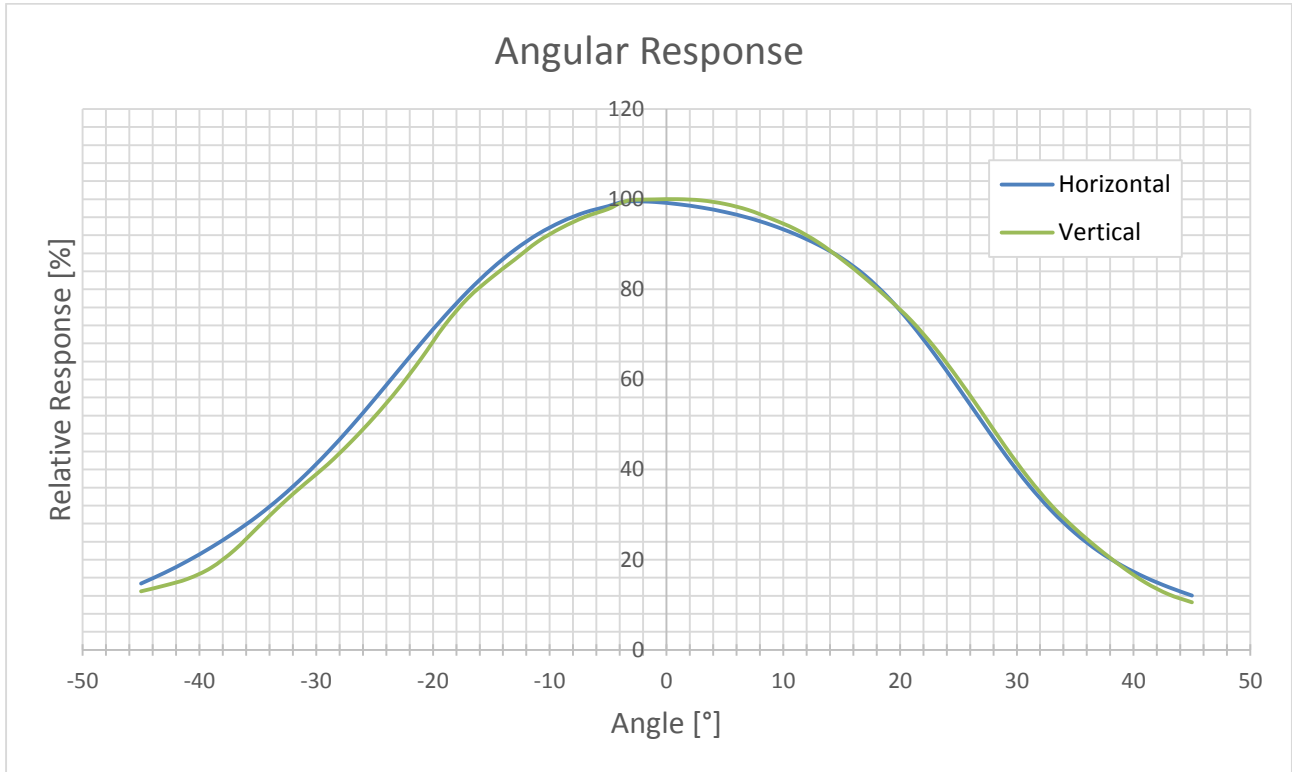

FIGURE 53: RESPONSE OF E12 DEVICES AND NORMAL DEVICES

## 10 ANGULAR RESPONSE

The typical angular response for a CMV2000 sensor can be seen in the chart below. The data includes the horizontal and vertical angles.



**FIGURE 54: HORIZONTAL AND VERTICAL ANGULAR RESPONSE**

## 11 PINNING

Pins that are marked as optional are not strictly required for sensor operation, they are test pins or pins that are only needed for using a certain feature. When these pins are not used, they can be left floating.

When all 16 LVDS channels are not used, and the sensor is configured for multiplexing, the unused output channels can also be left floating.

### 11.1 PIN LIST

The pin list of the CMV2000 can be found below for the  $\mu$ PGA and LCC packages. The pin list for the LGA package is the same as for the  $\mu$ PGA package.

$\mu$ PGA	LCC	Pin name	Description	Type
G7	60	Tana	Test pin for analog signals (optional)	Analog output
D12	42	REF_ADC	Reference for ADC testing (decouple with 100nF to ground)	Bias
E10	41	SG_ADC	Signal for ADC testing (decouple with 100nF to ground)	Bias
E11	40	Vramp1	Start voltage first ramp (decouple with 100nF to ground)	Bias
E12	39	Vramp2	Start voltage second ramp (decouple with 100nF to ground)	Bias
F6	62	Vpch_H	Precharge high voltage (decouple with 100nF to ground)	Bias
H8	57	Vres_L	Reset low voltage (decouple with 100nF to ground)	Bias
F8	54	Vtf_I2	Transfer low voltage 2 (decouple with 100nF to ground)	Bias
H9	53	Vtf_I3	Transfer low voltage 3 (decouple with 100nF to ground)	Bias
D11	43	VREF	Reference for column amps (decouple with 100nF to ground)	Bias
F9	51	Col_load	Decouple with 100nF to ground	Bias
G9	52	Col_amp	Decouple with 100nF to ground	Bias
G6	63	CMD_N	Decouple with 100nF to ground	Bias
G11	45	Vbgap	Decouple with 100nF to ground	Bias
H10	50	COL_PC	Decouple with 100nF to ground	Bias
H11	44	LVDS	Decouple with 100nF to ground	Bias
G5	66	CMD_P	Decouple with 100nF to VDD33	Bias
F5	65	CMD_P_INV	Decouple with 100nF to VDD33	Bias
F10	48	ramp	Decouple with 100nF to VDD33	Bias
G10	49	ADC	Decouple with 100nF to VDD33	Bias
G8	55	Vtf_I1	Transfer low voltage 1 (connect to ground)	Bias
H5	67	SYS_RES_N	Input pin for sequencer reset	Digital input
E1	80	CLK_IN	Master input clock	Digital input
F2	76	FRAME_REQ	Frame request pin	Digital input
G3	72	T_EXP2	Input pin for external exposure mode (optional)	Digital input
H3	75	T_EXP1	Input pin for external exposure mode (optional)	Digital input
G4	69	SPI_EN	SPI enable input pin	Digital input
H4	70	SPI_CLK	SPI clock input pin	Digital input
F3	71	SPI_IN	SPI data input pin	Digital input
F4	68	SPI_OUT	SPI data output pin	Digital output
G2	N.E.	TDIG2	Test pin for digital signals (optional)	Digital output
H2	77	TDIG1	Test pin for digital signals (optional)	Digital output
A6	8	GND	Ground pin	Ground
A12	22	GND	Ground pin	Ground
C1	28	GND	Ground pin	Ground
C6	38	GND	Ground pin	Ground
C12	47	GND	Ground pin	Ground
E3	56	GND	Ground pin	Ground
E5	64	GND	Ground pin	Ground
E9	73	GND	Ground pin	Ground
F1	81	GND	Ground pin	Ground

F12	87	GND	Ground pin	Ground
H7	92	GND	Ground pin	Ground
D1	79	LVDS_CLK_P	LVDS positive input clock	LVDS input
D2	78	LVDS_CLK_N	LVDS negative input clock	LVDS input
B11	25	OUTCLK_N	LVDS negative clock output channel	LVDS output
B12	26	OUTCLK_P	LVDS positive clock output channel	LVDS output
B1	2	OUTCTR_N	LVDS negative control output channel	LVDS output
B2	3	OUTCTR_P	LVDS positive control output channel	LVDS output
C2	4	OUT1_N	LVDS negative data output channel 1	LVDS output
C3	5	OUT1_P	LVDS positive data output channel 1	LVDS output
A2	6	OUT2_N	LVDS negative data output channel 2	LVDS output
A3	7	OUT2_P	LVDS positive data output channel 2	LVDS output
D3	91	OUT3_N	LVDS negative data output channel 3	LVDS output
D4	90	OUT3_P	LVDS positive data output channel 3	LVDS output
B3	89	OUT4_N	LVDS negative data output channel 4	LVDS output
B4	88	OUT4_P	LVDS positive data output channel 4	LVDS output
A4	10	OUT5_N	LVDS negative data output channel 5	LVDS output
A5	11	OUT5_P	LVDS positive data output channel 5	LVDS output
C4	86	OUT6_N	LVDS negative data output channel 6	LVDS output
C5	85	OUT6_P	LVDS positive data output channel 6	LVDS output
B5	12	OUT7_N	LVDS negative data output channel 7	LVDS output
B6	13	OUT7_P	LVDS positive data output channel 7	LVDS output
D5	83	OUT8_N	LVDS negative data output channel 8	LVDS output
D6	82	OUT8_P	LVDS positive data output channel 8	LVDS output
D7	36	OUT9_N	LVDS negative data output channel 9	LVDS output
D8	35	OUT9_P	LVDS positive data output channel 9	LVDS output
B7	15	OUT10_N	LVDS negative data output channel 10	LVDS output
B8	16	OUT10_P	LVDS positive data output channel 10	LVDS output
C8	17	OUT11_N	LVDS negative data output channel 11	LVDS output
C9	18	OUT11_P	LVDS positive data output channel 11	LVDS output
A8	34	OUT12_N	LVDS negative data output channel 12	LVDS output
A9	33	OUT12_P	LVDS positive data output channel 12	LVDS output
B9	19	OUT13_N	LVDS negative data output channel 13	LVDS output
B10	20	OUT13_P	LVDS positive data output channel 13	LVDS output
D9	32	OUT14_N	LVDS negative data output channel 14	LVDS output
D10	31	OUT14_P	LVDS positive data output channel 14	LVDS output
A10	30	OUT15_N	LVDS negative data output channel 15	LVDS output
A11	29	OUT15_P	LVDS positive data output channel 15	LVDS output
C10	23	OUT16_N	LVDS negative data output channel 16	LVDS output
C11	24	OUT16_P	LVDS positive data output channel 16	LVDS output
A7	9	VDD20	2.1V supply	Supply
C7	21	VDD20	2.1V supply	Supply
E4	37	VDD20	2.1V supply	Supply
E7	59	VDD20	2.1V supply	Supply
E8	84	VDD20	2.1V supply	Supply
E6	14	VDDPIX	3.0V supply	Supply
G1	46	VDDPIX	3.0V supply	Supply
G12	74	VDDPIX	3.0V supply	Supply
F7	58	Vres_H	3.3V supply	Supply
E2	1	VDD33	3.3V supply	Supply
H1	27	VDD33	3.3V supply	Supply
H6	61	VDD33	3.3V supply	Supply
F11	N.E.	DIO1	Diode 1 for test (not connected)	Test
H12	N.E.	DIO2	Diode 2 for test (not connected)	Test

N.E: Not equipped

### 11.2 $\mu$ PGA AND LGA PIN LAYOUT

This is the pin layout as seen from the top.

H	VDD33	TDIG1	T_EXP1	SPI_CLK	SYS_RES_N	VDD33	GND	Vres_L	Vtf_I3	COL_PC	LVDS	DIO2
G	VDDPIX	TDIG2	T_EXP2	SPI_EN	CMD_P	CMD_N	Tana	Vtf_I1	Col_amp	ADC	Vbgap	VDDPIX
F	GND	FRAME_REQ	SPI_IN	SPI_OUT	CMD_P_INV	Vpch_H	Vres_H	Vtf_I2	Col_load	Ramp	DIO1	GND
E	CLK_IN	VDD33	GND	VDD20	GND	VDDPIX	VDD20	VDD20	GND	SG_ADC	Vramp1	Vramp2
D	LVDS_CLK_P	LVDS_CLK_N	OUT3_N	OUT3_P	OUT8_N	OUT8_P	OUT9_N	OUT9_P	OUT14_N	OUT14_P	VREF	REF_ADC
C	GND	OUT1_N	OUT1_P	OUT6_N	OUT6_P	GND	VDD20	OUT11_N	OUT11_P	OUT16_N	OUT16_P	GND
B	OUT_CTR_N	OUT_CTR_P	OUT4_N	OUT4_P	OUT7_N	OUT7_P	OUT10_N	OUT10_P	OUT13_N	OUT13_P	OUT_CLK_N	OUT_CLK_P
A		OUT2_N	OUT2_P	OUT5_N	OUT5_P	GND	VDD20	OUT12_N	OUT12_P	OUT15_N	OUT15_P	GND
	<b>1</b>	<b>2</b>	<b>3</b>	<b>4</b>	<b>5</b>	<b>6</b>	<b>7</b>	<b>8</b>	<b>9</b>	<b>10</b>	<b>11</b>	<b>12</b>

**FIGURE 55:  $\mu$ PGA AND LGA PIN LAYOUT**

### 11.3 LCC PIN LAYOUT

This is the pin layout as seen from the bottom.

	GND	Ramp	ADC	COL_PC	Col_load	Col_amp	Vtf_I3	Vtf_I2	Vtf_I1	GND	Vres_L	Vres_H	VDD20	Tana	VDD33	Vpc_H	CMD_N	GND	CMD_P_INV	CMD_P	SYS_RES_N	SPI_OUT	SPI_EN	SPI_CLK	SPI_IN	T_EXP2	GND
	47	48	49	50	51	52	53	54	55	56	57	58	59	60	61	62	63	64	65	66	67	68	69	70	71	72	73
VDDPIX	46																									74	VDDPIX
Vbgap	45																									75	T_EXP1
LVDS	44																									76	FRAME_REQ
VREF	43																									77	TDIG1
REF_ADC	42																									78	LVDS_CLK_N
SG_ADC	41																									79	LVDS_CLK_P
Vramp1	40																									80	CLK_IN
Vramp2	39																									81	GND
GND	38																									82	OUT8_P
VDD20	37																									83	OUT8_N
OUT9_N	36																									84	VDD20
OUT9_P	35																									85	OUT6_P
OUT12_N	34																									86	OUT6_N
OUT12_P	33																									87	GND
OUT14_N	32																									88	OUT4_P
OUT14_P	31																									89	OUT4_N
OUT15_N	30																									90	OUT3_P
OUT15_P	29																									91	OUT3_N
GND	28																									92	GND
VDD33	27	OUTCLK_P	OUTCLK_N	OUT16_P	OUT16_N	GND	VDD20	OUT13_P	OUT13_N	OUT11_P	OUT11_N	OUT10_P	OUT10_N	VDDPIX	OUT7_P	OUT7_N	OUT5_P	OUT5_N	VDD20	GND	OUT2_P	OUT2_N	OUT1_P	OUT1_N	OUTCTR_P	OUTCTR_N	VDD33
	26	25	24	23	22	21	20	19	18	17	16	15	14	13	12	11	10	9	8	7	6	5	4	3	2	1	

**FIGURE 56: LCC PIN LAYOUT**



## 12 SPECIFICATION OVERVIEW

Specification	Value	Comment
Effective pixels	2048 x 1088	
Pixel pitch	5.5 x 5.5 $\mu\text{m}^2$	
Optical format	2/3"	
Full well charge	13.5 Ke <sup>-</sup>	Pinned photodiode pixel.
Conversion gain	0.075 LSB/e <sup>-</sup>	10 bit mode, unity gain
Sensitivity	5.56 V/lux.s 0.27 A/W	With microlenses @550nm
Temporal noise (analog domain)	13 e <sup>-</sup>	Pipelined global shutter (GS) with correlated double sampling (CDS). Read noise.
Dynamic range	60 dB	
Pixel type	Global shutter pixel	Allows fixed pattern noise correction and reset (kTC) noise canceling through correlated double sampling.
Shutter type	Pipelined global shutter	Exposure of next image during read-out of the previous image.
Parasitic light sensitivity - Shutter efficiency	<1/50 000 >99.998%	
Color filters	Optional	RGB Bayer pattern
Microlenses	Yes	
Fill Factor	42%	Without microlenses
QE * FF	60%	@ 550 nm with micro lenses.
Dark current signal	125 e <sup>-</sup> /s	@ 25°C die temperature
DSNU	3 LSB/s	10 bit mode
Fixed pattern noise	<1 LSB RMS	<0.1% of full swing, 10 bit mode
PRNU	< 1% RMS of signal	
LVDS Output channel	16	Each data output running @ 480 Mbit/s. 8, 4 and 2 outputs selectable at reduced frame rate
Frame rate	340 frames/s	Using a 10bit/pixel and 480 Mbit/s LVDS. Higher frame rate possible in row windowing mode.
Timing generation	On-chip	Possibility to control exposure time through external pin.
PGA	Yes	4 analog gain settings
Programmable Registers	Sensor parameters	Window coordinates, Timing parameters, Gain & offset, Exposure time, flipped read-out in x and y direction ...
Supported HDR modes	Multi-frame read-out with different exposure time  Interleaved integration times  Piecewise linear response	Successive frames are read out with increasing exposure times. The final image is a combination (externally) of these frames.  Interleaved exposure times for different rows: Odd rows (double rows for color) have a different exposure compared to even rows (double rows for color). Final image is a combination of the two (through interpolation).  Response curve with two knee points
ADC	10 bit/12bit	Column ADC
Interface	LVDS	Serial output data + synchronization signals
I/O logic levels	LVDS = 1.8V Dig. I/O = 3.3V	
Supply voltages	2.1V 3.0V 3.3V	LVDS, ADC Pixel array supply Dig. I/O, SPI, PGA

Specification	Value	Comment
Clock inputs	CLK_IN LVDS_CLK_N/P SPI_CLK	Between 5 and 48MHz Between 50 and 480MHz, LVDS Max. 48MHz
Power	550mW to 1200mW	Actual wattage is dependent on the used configuration
Package	Custom ceramic package	μPGA (95 pins) LGA (95 pins) LCC (92 pins)
Operating range	-30°C to +70°C	Dark current and noise performance will degrade at higher temperature
Cover glass	D263	Plain or AR glass, no IR cut-off filter on color devices
ESD	Class 1A HBM Class 4C CDM	
RoHS	Compliant	

## 13 ORDERING INFO

Part Number	Epi Thickness	Chroma	Microlens	Package	Glass
CMV2000-2E5M1PP	5µm	Mono	Yes	Ceramic 95p µPGA	Plain
CMV2000-2E5M1LP	5µm	Mono	Yes	Ceramic 95p LGA	Plain
CMV2000-2E5M1CA	5µm	Mono	Yes	Ceramic 92p LCC	AR coated
CMV2000-2E5C1PP	5µm	RGB Bayer	Yes	Ceramic 95p µPGA	Plain
CMV2000-2E5C1LP	5µm	RGB Bayer	Yes	Ceramic 95p LGA	Plain
CMV2000-2E5C1CA	5µm	RGB Bayer	Yes	Ceramic 92p LCC	AR coated
CMV2000-2E12M1PP	12µm	Mono	Yes	Ceramic 95p µPGA	Plain
CMV2000-2E12M1LP	12µm	Mono	Yes	Ceramic 95p LGA	Plain
CMV2000-2E12M1CA	12µm	Mono	Yes	Ceramic 92p LCC	AR coated

On request the package and cover glass can be customized. For options, pricing and delivery time please contact [info@cmosis.com](mailto:info@cmosis.com)

## 14 HANDLING AND SOLDERING PROCEDURE

### 14.1 SOLDERING

#### 14.1.1 MANUAL SOLDERING

Use partial heating method and use a soldering iron with temperature control. The soldering iron tip temperature is not to exceed 350°C with 270°C maximum pin temperature, 2 seconds maximum duration per pin. Avoid global heating of the ceramic package during soldering. Failure to do so may alter device performance and reliability.

#### 14.1.2 WAVE SOLDERING

Wave soldering is possible but not recommended. Solder dipping can cause damage to the glass and harm the imaging capability of the device. See Figure 57 below for the wave soldering profile.

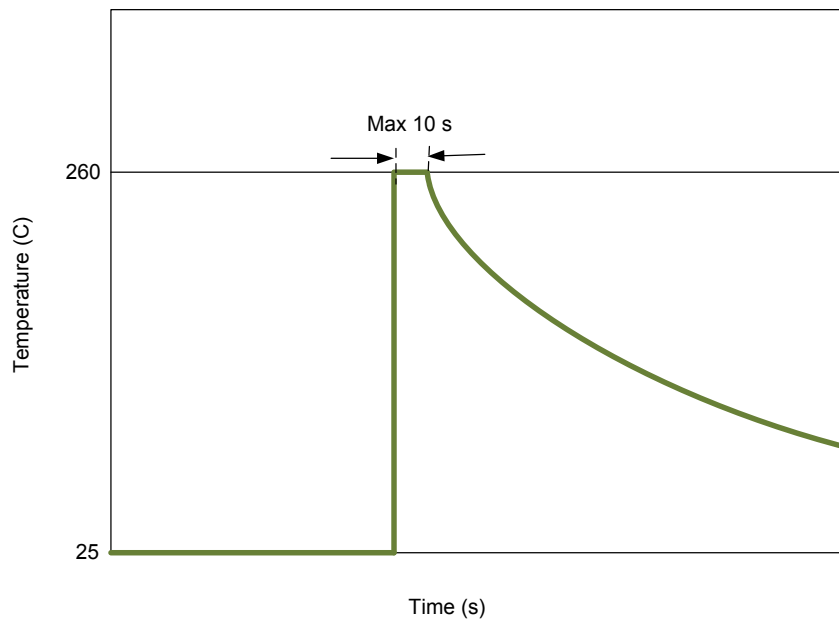

**FIGURE 57: WAVE SOLDER PROFILE**

### 14.1.3 REFLOW SOLDERING

Figure 58 below shows the maximum recommended thermal profile for a reflow soldering system. If the temperature/time profile exceeds these recommendations, damage to the image sensor can occur.

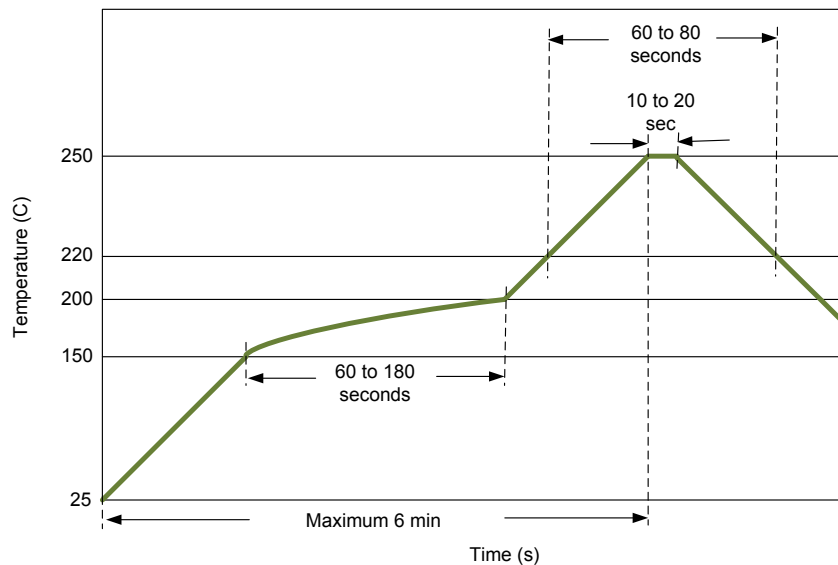

**FIGURE 58: REFLOW SOLDER PROFILE**

### 14.1.4 SOLDERING RECOMMENDATIONS

Image sensors with filter arrays (CFA) and micro-lens are especially sensitive to high temperatures. Prolonged heating at elevated temperatures may result in deterioration of the performance of the sensor. Best solution will be flow soldering or manual soldering of a socket (through hole or BGA) and plug in the sensor at latest stage of the assembly/test process. The BGA solution allows more flexibility for the routing of the camera PCB.

## 14.2 HANDLING IMAGE SENSORS

### 14.2.1 ESD

The following are the recommended minimum ESD requirements when handling image sensors.

1. Ground workspace (tables, floors...)
2. Ground handling personnel (wrist straps, special footwear...)
3. Minimize static charging (control humidity, use ionized air, wear gloves...)

### 14.2.2 GLASS CLEANING

When cleaning of the cover glass is needed we recommend the following two methods.

1. Blowing off the particles with ionized nitrogen
2. Wipe clean using IPA (isopropyl alcohol) and ESD protective wipes.

### 14.2.3 IMAGE SENSOR STORING

Image sensors should be stored under the following conditions

1. Dust free
2. Temperature 20°C to 40°C
3. Humidity between 30% and 60%.
4. Avoid radiation, electromagnetic fields, ESD, mechanical stress

## 15 EVALUATION KIT

To evaluate the performance of the CMV2000 sensor, a kit can be rented or purchased. This consists of a PCB with a ZIF socket for easily changing sensors and a lens mount in a sturdy metal box with a universal tripod adapter. Also included is a PC, with mouse and keyboard, with pre-installed demo software, a built-in frame grabber and all necessary power cables and CameraLink cables to power up and connect the PCB. The demo software allows the user to program all the sensor's registers and to view the images directly as they are grabbed from the sensor. For more information, please contact [info@cmosis.com](mailto:info@cmosis.com).

## 16 ADDITIONAL INFORMATION

For further questions related to the operation and specification of the CMV2000 imagers, or for feedback with respect to this datasheet please contact [techsupport@cmosis.com](mailto:techsupport@cmosis.com).