

4-Mbit (256K words × 16 bit) Static RAM with Error-Correcting Code (ECC)

Features

- High speed
 - $t_{AA} = 10 \text{ ns}$
- Temperature range
 - Automotive-E: $-40 \text{ }^\circ\text{C}$ to $125 \text{ }^\circ\text{C}$
 - Automotive-A: $-40 \text{ }^\circ\text{C}$ to $85 \text{ }^\circ\text{C}$
- Embedded ECC for single-bit error correction^[1]
- Low active and standby currents
 - Active current $I_{CC} = 40\text{-mA}$ typical
 - Standby current $I_{SB2} = 6\text{-mA}$ typical
- Operating voltage range: 2.2 V to 3.6 V
- 1.0-V data retention
- TTL- compatible inputs and outputs
- Pb-free 48-ball VFBGA and 44-pin TSOP II packages

Functional Description

CY7C1041G is a high-performance CMOS fast static RAM automotive part with embedded ECC. This device has a single Chip Enable (\overline{CE}) input and is accessed by asserting it LOW.

Data writes are performed by asserting the Write Enable (\overline{WE}) input LOW, while providing the data on I/O₀ through I/O₁₅ and the address on A₀ through A₁₇ pins. The Byte High Enable (\overline{BHE}) and Byte Low Enable (\overline{BLE}) inputs control write operations to the upper and lower bytes of the specified memory location. \overline{BHE} controls I/O₈ through I/O₁₅ and \overline{BLE} controls I/O₀ through I/O₇.

Data reads are performed by asserting the Output Enable (\overline{OE}) input and providing the required address on the address lines. Read data is accessible on the I/O lines (I/O₀ through I/O₁₅). Byte accesses can be performed by asserting the required byte enable signal (\overline{BHE} or \overline{BLE}) to read either the upper byte or the lower byte of data from the specified address location.

All I/Os (I/O₀ through I/O₁₅) are placed in a HI-Z state when the device is deselected (\overline{CE} LOW), or when the control signals are deasserted (\overline{OE} , \overline{BLE} , \overline{BHE}). Refer to the following logic block diagram.

Logic Block Diagram – CY7C1041G

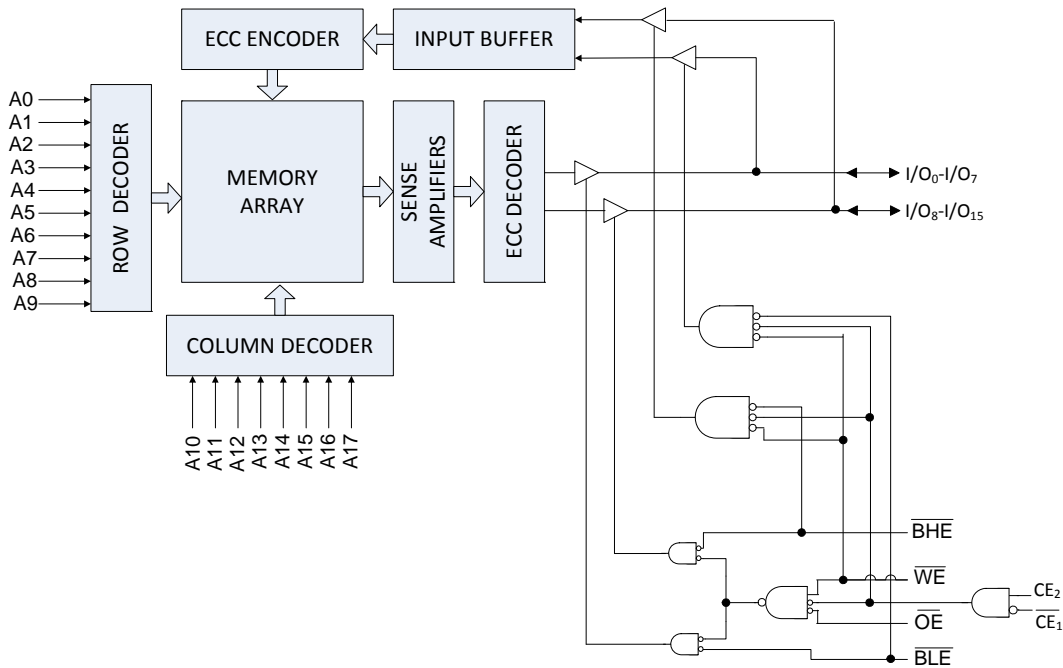

Note
1. This device does not support automatic write-back on error detection.

Contents

| | | | |
|---|-----------|--|-----------|
| Pin Configurations | 3 | Ordering Information | 12 |
| Product Portfolio | 3 | Ordering Code Definitions | 12 |
| Maximum Ratings | 4 | Package Diagrams | 13 |
| Operating Range | 4 | Acronyms | 14 |
| DC Electrical Characteristics | 4 | Document Conventions | 14 |
| Capacitance | 5 | Units of Measure | 14 |
| Thermal Resistance | 5 | Document History Page | 15 |
| AC Test Loads and Waveforms | 5 | Sales, Solutions, and Legal Information | 16 |
| Data Retention Characteristics | 6 | Worldwide Sales and Design Support | 16 |
| Data Retention Waveform | 6 | Products | 16 |
| AC Switching Characteristics | 7 | PSoC® Solutions | 16 |
| Switching Waveforms | 8 | Cypress Developer Community | 16 |
| Truth Table | 11 | Technical Support | 16 |

Pin Configurations

Figure 1. 48-ball VFBGA Pinout^[2]

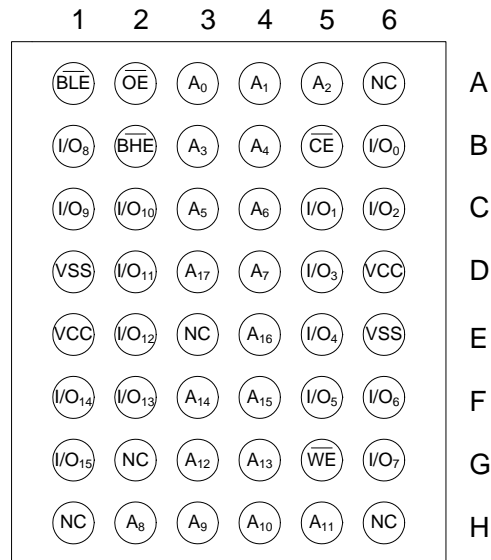
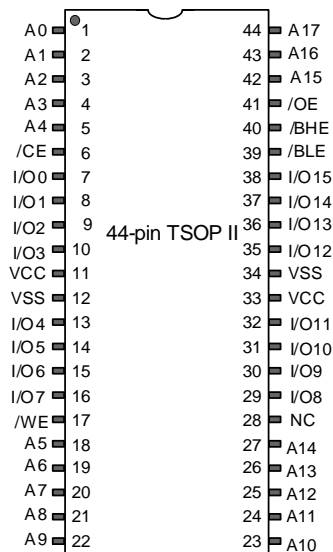

Figure 2. 44-pin TSOP II Pinout^[2]



Product Portfolio

| Product | Range | V _{CC} Range (V) | Speed (ns) | Power Dissipation | | | |
|-----------|--------------|---------------------------|------------|--|-----|--------------------------------|-----|
| | | | | Operating I _{CC} , (mA), f = f _{max} | | Standby, I _{SB2} (mA) | |
| | | | | Typ ^[3] | Max | Typ ^[3] | Max |
| CY7C1041G | Automotive-E | 2.2 V–3.6 V | 10 | 40 | 50 | 6 | 14 |
| | Automotive-A | | | 38 | 45 | 6 | 8 |

Notes

- 2. NC pins are not connected internally to the die.
- 3. Typical values are included for reference only and are not guaranteed or tested.

Maximum Ratings

Exceeding maximum ratings may impair the useful life of the device. These user guidelines are not tested.

- Storage temperature -65 °C to +150 °C
- Ambient temperature with power applied -55 °C to +125 °C
- Supply voltage on V_{CC} relative to GND^[4] -0.5 V to V_{CC} + 0.3 V
- DC voltage applied to outputs in HI-Z State^[4] -0.3 V to V_{CC} + 0.3 V
- DC input voltage^[4] -0.3 V to V_{CC} + 0.3 V

- Current into outputs (in low state) 20 mA
- Static discharge voltage (MIL-STD-883, Method 3015) > 2001 V
- Latch-up current > 140 mA

Operating Range

| Grade | Ambient Temperature | V _{CC} |
|--------------|---------------------|-----------------|
| Automotive-E | -40 °C to +125 °C | 2.2 V to 3.6 V |
| Automotive-A | -40 °C to +85 °C | 2.2 V to 3.6 V |

DC Electrical Characteristics

Over the Operating Range

| Parameter | Description | Test Conditions | 10 ns (Automotive-E) | | | 10 ns (Automotive-A) | | | Unit |
|------------------|---|--|----------------------|-----|--------------------------------------|----------------------|-----|--------------------------------------|------|
| | | | Min | Typ | Max | Min | Typ | Max | |
| V _{OH} | Output HIGH voltage | 2.2 V to 2.7 V V _{CC} = Min, I _{OH} = -1.0 mA | 2 | - | - | 2 | - | - | V |
| | | 2.7 V to 3.0 V V _{CC} = Min, I _{OH} = -4.0 mA | 2.2 | - | - | 2.2 | - | - | |
| | | 3.0 V to 3.6 V V _{CC} = Min, I _{OH} = -4.0 mA | 2.4 | - | - | 2.4 | - | - | |
| V _{OL} | Output LOW voltage | 2.2 V to 2.7 V V _{CC} = Min, I _{OL} = 2 mA | - | - | 0.4 | - | - | 0.4 | V |
| | | 2.7 V to 3.6 V V _{CC} = Min, I _{OL} = 8 mA | - | - | 0.4 | - | - | 0.4 | |
| V _{IH} | Input HIGH voltage | 2.2 V to 2.7 V | 2 | - | V _{CC} + 0.3 ^[4] | 2 | - | V _{CC} + 0.3 ^[4] | V |
| | | 2.7 V to 3.6 V | 2 | - | V _{CC} + 0.3 ^[4] | 2 | - | V _{CC} + 0.3 ^[4] | |
| V _{IL} | Input LOW voltage | 2.2 V to 2.7 V | -0.3 ^[4] | - | 0.6 | -0.3 ^[4] | - | 0.6 | V |
| | | 2.7 V to 3.6 V | -0.3 ^[4] | - | 0.8 | -0.3 ^[4] | - | 0.8 | |
| I _{IX} | Input leakage current | GND ≤ V _{IN} ≤ V _{CC} | -5 | - | +5 | -1 | - | +1 | μA |
| I _{OZ} | Output leakage current | GND ≤ V _{OUT} ≤ V _{CC} , Output disabled | -5 | - | +5 | -1 | - | +1 | μA |
| I _{CC} | Operating supply current | V _{CC} = 3.6 V, I _{OUT} = 0 mA, CMOS levels f = f _{MAX} = 1/t _{RC} | - | 40 | 50 | - | 38 | 45 | mA |
| I _{SB1} | Automatic CE power down current – TTL inputs | V _{CC} = 3.6 V, $\overline{CE} \geq V_{IH}$, V _{IN} ≥ V _{IH} or V _{IN} ≤ V _{IL} , f = f _{MAX} | - | - | 24 | - | - | 15 | mA |
| I _{SB2} | Automatic CE power down current – CMOS inputs | V _{CC} = 3.6 V, $\overline{CE} \geq V_{CC} - 0.2 V$, V _{IN} ≥ V _{CC} - 0.2 V or V _{IN} ≤ 0.2 V, f = 0 | - | 6 | 14 | - | 6 | 8 | mA |

Note
4. V_{IL(min)} = -2.0 V and V_{IH(max)} = V_{CC} + 2 V for pulse durations of less than 20 ns.

Capacitance

| Parameter ^[5] | Description | Test Conditions | All Packages | Unit |
|--------------------------|-------------------|---|--------------|------|
| C _{IN} | Input capacitance | T _A = 25 °C, f = 1 MHz, V _{CC} = V _{CC(typ)} | 10 | pF |
| C _{OUT} | I/O capacitance | | 10 | pF |

Thermal Resistance

| Parameter ^[5] | Description | Test Conditions | 48-ball VFBGA | 44-pin TSOPII | Unit |
|--------------------------|--|---|---------------|---------------|------|
| Θ _{JA} | Thermal resistance (junction to ambient) | Still air, soldered on a 3 x 4.5 inch, four layer printed circuit board | 30.68 | 66.82 | °C/W |
| Θ _{JC} | Thermal resistance (junction to case) | | 14.83 | 15.97 | °C/W |

AC Test Loads and Waveforms

Figure 3. AC Test Loads and Waveforms^[6]

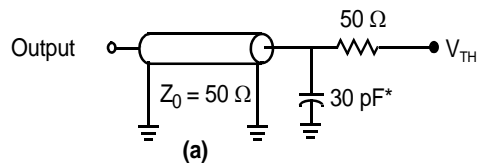

* Capacitive load consists of all components of the test environment

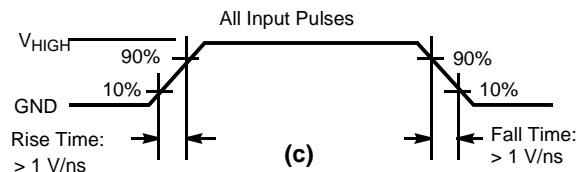
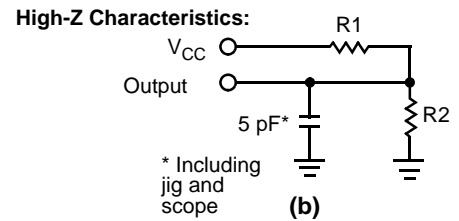

| Parameters | 3.0 V | Unit |
|-------------------|-------|------|
| R1 | 317 | Ω |
| R2 | 351 | Ω |
| V _{TH} | 1.5 | V |
| V _{HIGH} | 3 | V |

Notes

5. Tested initially and after any design or process change that may affect these parameters.
6. Full-device AC operation assumes a 100-μs ramp time from 0 to V_{CC(min)} and a 100-μs wait time after V_{CC} stabilization.

Data Retention Characteristics

Over the Operating Range

| Parameter | Description | Conditions | Automotive-E | | Automotive-A | | Unit |
|-----------------|--------------------------------------|---|--------------|-----|--------------|-----|------|
| | | | Min | Max | Min | Max | |
| V_{DR} | V_{CC} for data retention | – | 1 | – | 1 | – | V |
| I_{CCDR} | Data retention current | $V_{CC} = 1.2\text{ V}$, $\overline{CE} \geq V_{CC} - 0.2\text{ V}$, $V_{IN} \geq V_{CC} - 0.2\text{ V}$ or $V_{IN} \leq 0.2\text{ V}$ | – | 14 | – | 8 | mA |
| $t_{CDR}^{[7]}$ | Chip deselect to data retention time | – | 0 | – | 0 | – | ns |
| $t_R^{[7,8]}$ | Operation recovery time | $V_{CC} \geq 2.2\text{ V}$ | 10 | – | 10 | – | ns |

Data Retention Waveform

Figure 4. Data Retention Waveform^[8]

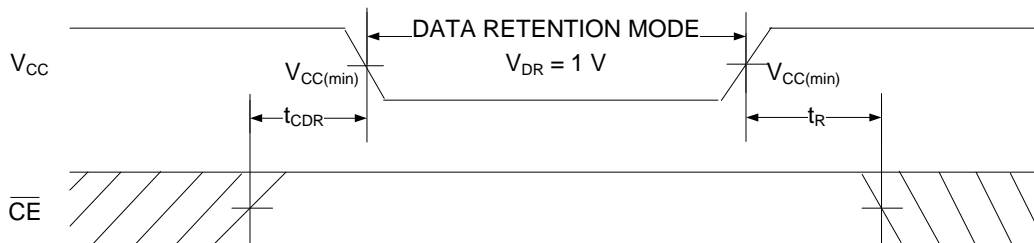

Notes

- These parameters are guaranteed by design.
- Full-device operation requires linear V_{CC} ramp from V_{DR} to $V_{CC(min.)} \geq 100\ \mu\text{s}$ or stable at $V_{CC(min.)} \geq 100\ \mu\text{s}$.

AC Switching Characteristics

Over the Operating Range

| Parameter ^[9] | Description | 10 ns (Automotive-A/ Automotive-E) | | Unit |
|---------------------------------------|--|------------------------------------|-----|------|
| | | Min | Max | |
| Read Cycle | | | | |
| t _{RC} | Read cycle time | 10 | – | ns |
| t _{AA} | Address to data | – | 10 | ns |
| t _{OHA} | Data | 3 | – | ns |
| t _{ACE} | \overline{CE} LOW to data ^[10] | – | 10 | ns |
| t _{DOE} | \overline{OE} LOW to data | – | 4.5 | ns |
| t _{LZOE} | \overline{OE} LOW to low impedance ^[11, 12] | 0 | – | ns |
| t _{HZOE} | \overline{OE} HIGH to HI-Z ^[11, 12] | – | 5 | ns |
| t _{LZCE} | \overline{CE} LOW to low impedance ^[10, 11, 12] | 3 | – | ns |
| t _{HZCE} | \overline{CE} HIGH to HI-Z ^[10, 11, 12] | – | 5 | ns |
| t _{PU} | \overline{CE} LOW to power up ^[10, 12] | 0 | – | ns |
| t _{PD} | \overline{CE} HIGH to power down ^[10, 12] | – | 10 | ns |
| t _{DBE} | Byte enable to data valid | – | 4.5 | ns |
| t _{LZBE} | Byte enable to low impedance ^[12] | 0 | – | ns |
| t _{HZBE} | Byte disable to HI-Z ^[12] | – | 6 | ns |
| Write Cycle^[13, 14] | | | | |
| t _{WC} | Write cycle time | 10 | – | ns |
| t _{SCE} | \overline{CE} LOW to write end ^[9] | 7 | – | ns |
| t _{AW} | Address setup to write end | 7 | – | ns |
| t _{HA} | Address hold from write end | 0 | – | ns |
| t _{SA} | Address setup to write start | 0 | – | ns |
| t _{PWE} | \overline{WE} pulse width | 7 | – | ns |
| t _{SD} | Data setup to write end | 5 | – | ns |
| t _{HD} | Data hold from write end | 0 | – | ns |
| t _{LZWE} | \overline{WE} HIGH to low impedance ^[11, 12] | 3 | – | ns |
| t _{HZWE} | \overline{WE} LOW to HI-Z ^[11, 12] | – | 5 | ns |
| t _{BW} | Byte Enable to write end | 7 | – | ns |

Notes

9. Test conditions assume a signal transition time (rise/fall) of 3 ns or less, timing reference levels of 1.5 V (for $V_{CC} \geq 3$ V) and $V_{CC}/2$ (for $V_{CC} < 3$ V), and input pulse levels of 0 to 3 V (for $V_{CC} \geq 3$ V) and 0 to V_{CC} (for $V_{CC} < 3$ V). Test conditions for the read cycle use output loading shown in part (a) of Figure 3 on page 5, unless specified otherwise.
10. For all dual chip enable devices, \overline{CE} is the logical combination of \overline{CE}_1 and \overline{CE}_2 . When \overline{CE}_1 is LOW and \overline{CE}_2 is HIGH, \overline{CE} is LOW; when \overline{CE}_1 is HIGH or \overline{CE}_2 is LOW, \overline{CE} is HIGH.
11. t_{HZOE}, t_{HZCE}, t_{HZWE}, t_{HZBE}, t_{LZOE}, t_{LZCE}, t_{LZWE}, and t_{LZBE} are specified with a load capacitance of 5 pF as in (b) of Figure 3 on page 5. Transition is measured ± 200 mV from steady state voltage.
12. These parameters are guaranteed by design and are not tested.
13. The internal write time of the memory is defined by the overlap of $\overline{WE} = V_{IL}$, $\overline{CE} = V_{IL}$ and \overline{BHE} or $\overline{BLE} = V_{IL}$. These signals must be LOW to initiate a write, and the HIGH transition of any of these signals can terminate the operation. The input data setup and hold timing should be referenced to the edge of the signal that terminates the write.
14. The minimum write cycle pulse width for Write Cycle No. 2 (\overline{WE} Controlled, \overline{OE} LOW) should be equal to sum of t_{SD} and t_{HZWE}.

Figure 7. Write Cycle No. 1 (\overline{CE} Controlled)^[17, 18, 19]

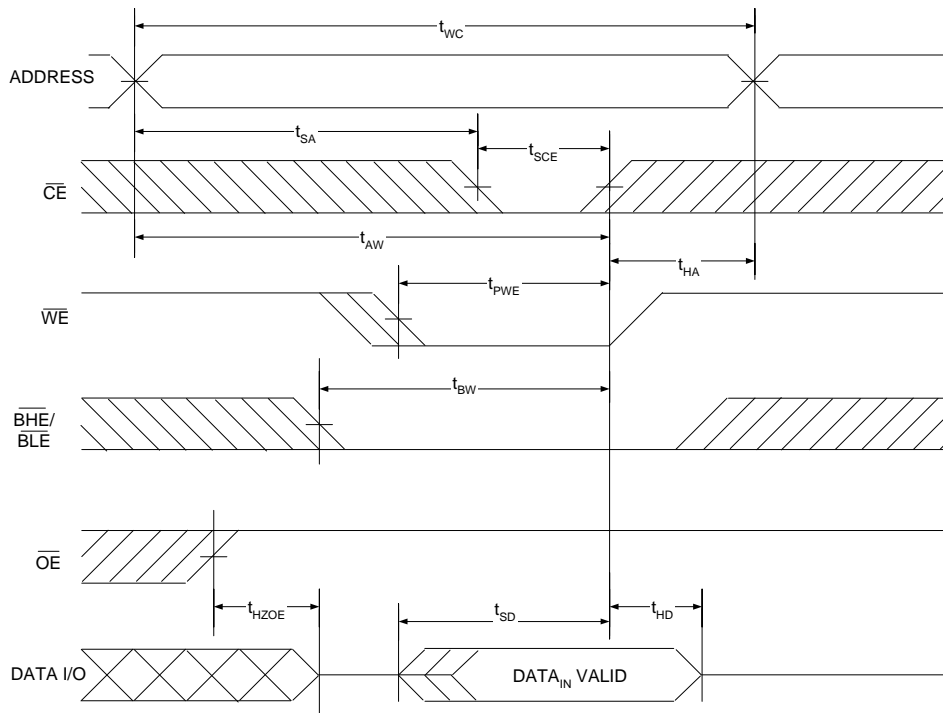
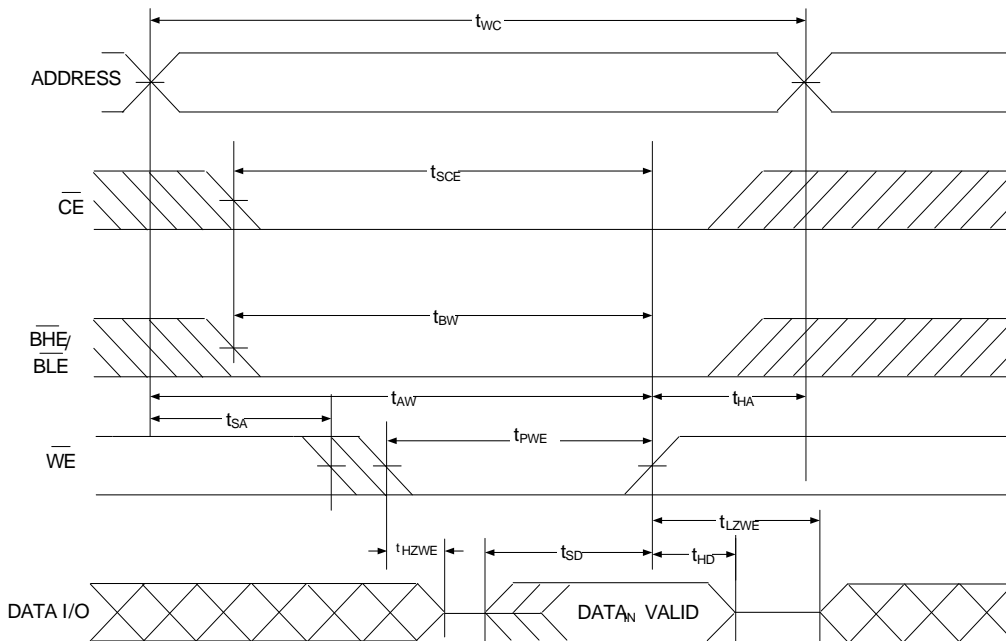

Figure 8. Write Cycle No. 2 (\overline{WE} Controlled, \overline{OE} LOW)^[17, 18, 19, 20]



Notes

- 17. Address valid prior to or coincident with \overline{CE} LOW transition.
- 18. The internal write time of the memory is defined by the overlap of $\overline{WE} = V_{IL}$, $\overline{CE} = V_{IL}$ and \overline{BHE} or $\overline{BLE} = V_{IL}$. These signals must be LOW to initiate a write, and the HIGH transition of any of these signals can terminate the operation. The input data setup and hold timing should be referenced to the edge of the signal that terminates the write.
- 19. Data I/O is in HI-Z state if $\overline{CE} = V_{IH}$, or $\overline{OE} = V_{IH}$ or \overline{BHE} , and/or $\overline{BLE} = V_{IH}$.
- 20. The minimum write cycle pulse width should be equal to sum of t_{SD} and t_{HZWE} .

Figure 9. Write Cycle No. 3 ($\overline{\text{BLE}}$ or $\overline{\text{BHE}}$ Controlled)^[21, 22]

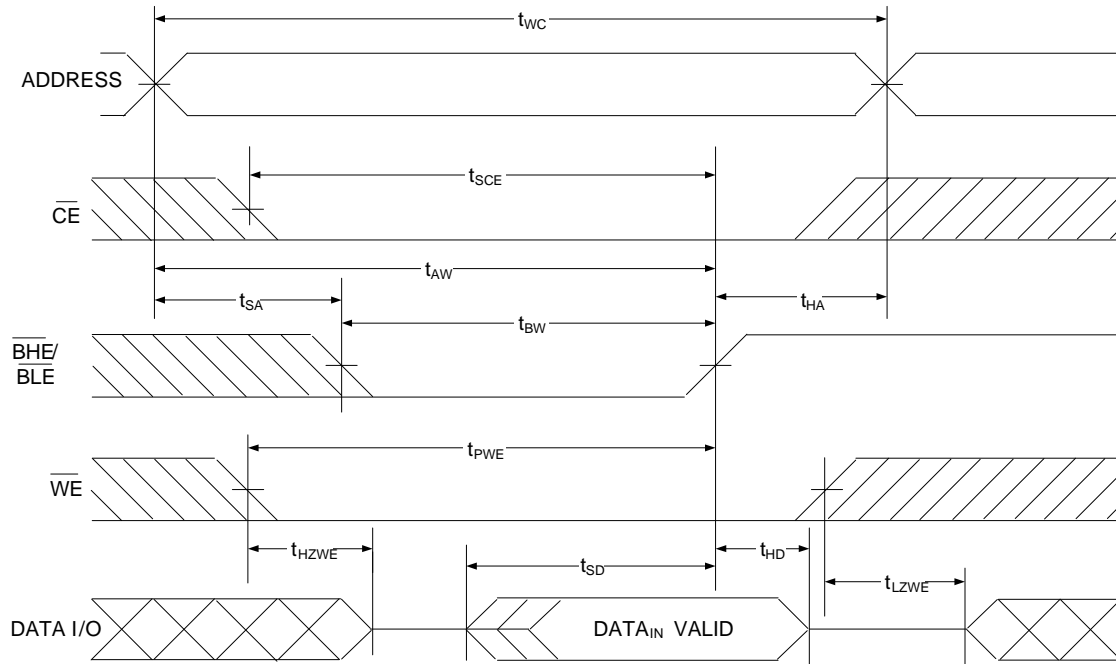
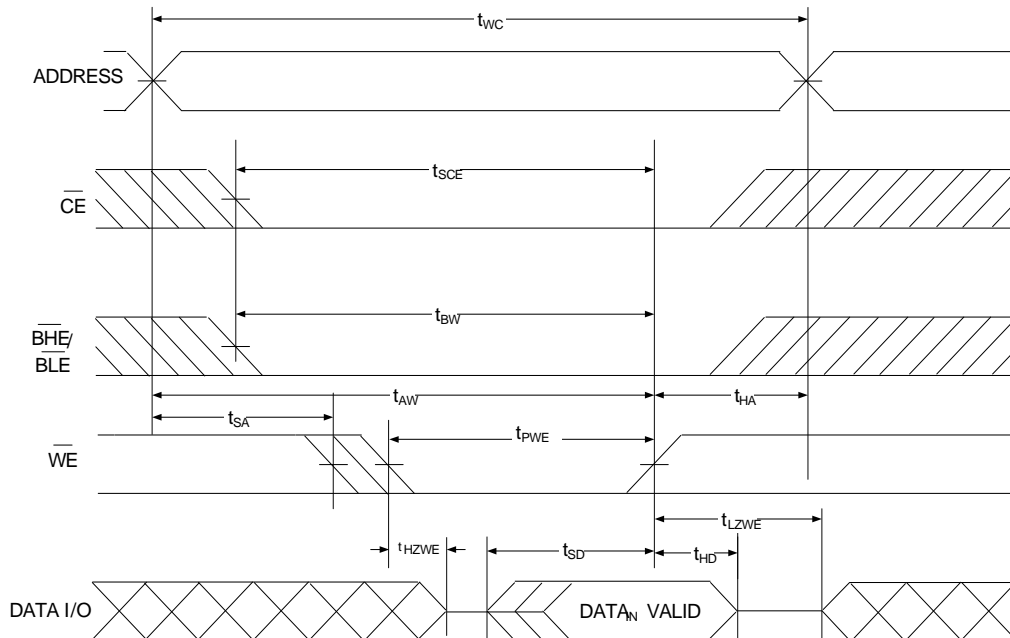

Figure 10. Write Cycle No. 4 (WE Controlled)^[21, 22, 23]



Notes

- 21. The internal write time of the memory is defined by the overlap of $\overline{\text{WE}} = V_{\text{IL}}$, $\overline{\text{CE}} = V_{\text{IL}}$ and $\overline{\text{BHE}}$ or $\overline{\text{BLE}} = V_{\text{IL}}$. These signals must be LOW to initiate a write, and the HIGH transition of any of these signals can terminate the operation. The input data setup and hold timing should be referenced to the edge of the signal that terminates the write.
- 22. Data I/O is in HI-Z state if $\overline{\text{CE}} = V_{\text{IH}}$, or $\overline{\text{OE}} = V_{\text{IH}}$ or $\overline{\text{BHE}}$, and/or $\overline{\text{BLE}} = V_{\text{IH}}$.
- 23. Data I/O is high impedance if $\text{OE} = V_{\text{IH}}$.
- 24. During this period the I/Os are in output state. Do not apply input signals.

Truth Table

| \overline{CE} | \overline{OE} | \overline{WE} | \overline{BLE} | \overline{BHE} | I/O ₀ -I/O ₇ | I/O ₈ -I/O ₁₅ | Mode | Power |
|-----------------|-----------------|-----------------|------------------|------------------|------------------------------------|-------------------------------------|----------------------------|----------------------------|
| H | X | X | X | X | HI-Z | HI-Z | Power down | Standby (I _{SB}) |
| L | L | H | L | L | Data out | Data out | Read all bits | Active (I _{CC}) |
| L | L | H | L | H | Data out | HI-Z | Read lower bits only | Active (I _{CC}) |
| L | L | H | H | L | HI-Z | Data out | Read upper bits only | Active (I _{CC}) |
| L | X | L | L | L | Data in | Data in | Write all bits | Active (I _{CC}) |
| L | X | L | L | H | Data in | HI-Z | Write lower bits only | Active (I _{CC}) |
| L | X | L | H | L | HI-Z | Data in | Write upper bits only | Active (I _{CC}) |
| L | H | H | X | X | HI-Z | HI-Z | Selected, outputs disabled | Active (I _{CC}) |

Ordering Information

| Speed (ns) | Voltage Range | Ordering Code | Package Diagram | Package Type (all Pb-free) | Operating Range |
|------------|---------------|----------------------|-----------------|-----------------------------|-----------------|
| 10 | 2.2 V–3.6 V | CY7C1041G30-10BAJXE | 001-85259 | 48-ball VFBGA | Automotive-E |
| | | CY7C1041G30-10BAJXET | 001-85259 | 48-ball VFBGA, Tape & Reel | |
| | | CY7C1041G30-10ZSX E | 51-85087 | 44-pin TSOP II | |
| | | CY7C1041G30-10ZSXET | 51-85087 | 44-pin TSOP II, Tape & Reel | |
| | | CY7C1041G30-10ZSXA | 51-85087 | 44-pin TSOP II | Automotive-A |
| | | CY7C1041G30-10ZSXAT | 51-85087 | 44-pin TSOP II, Tape & Reel | |

Ordering Code Definitions

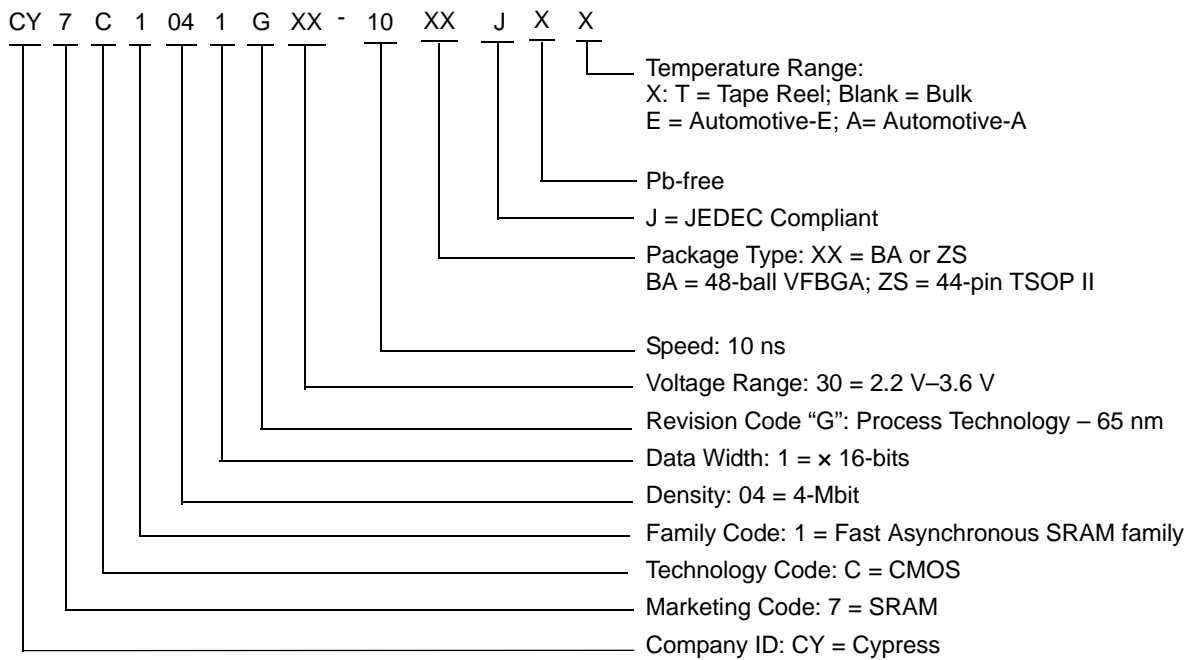

Package Diagrams

Figure 11. 48-ball VFBGA (6 × 8 × 1.2 mm) BA48M/BK48M (0.35 mm Ball Diameter) Package Outline, 001-85259

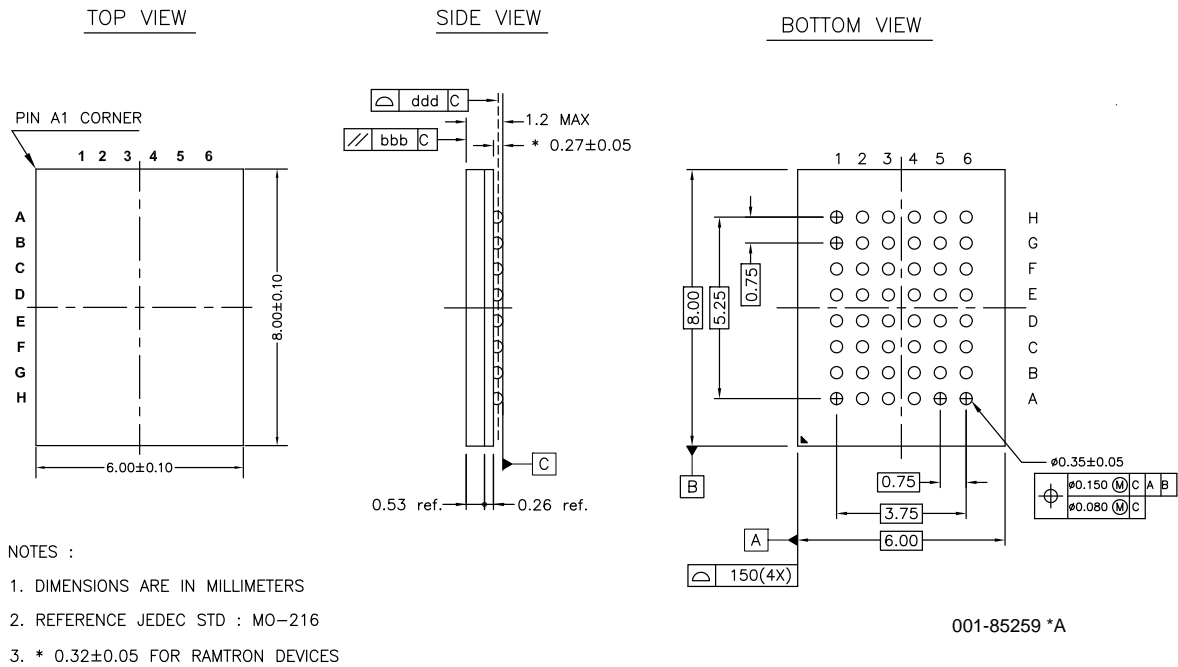
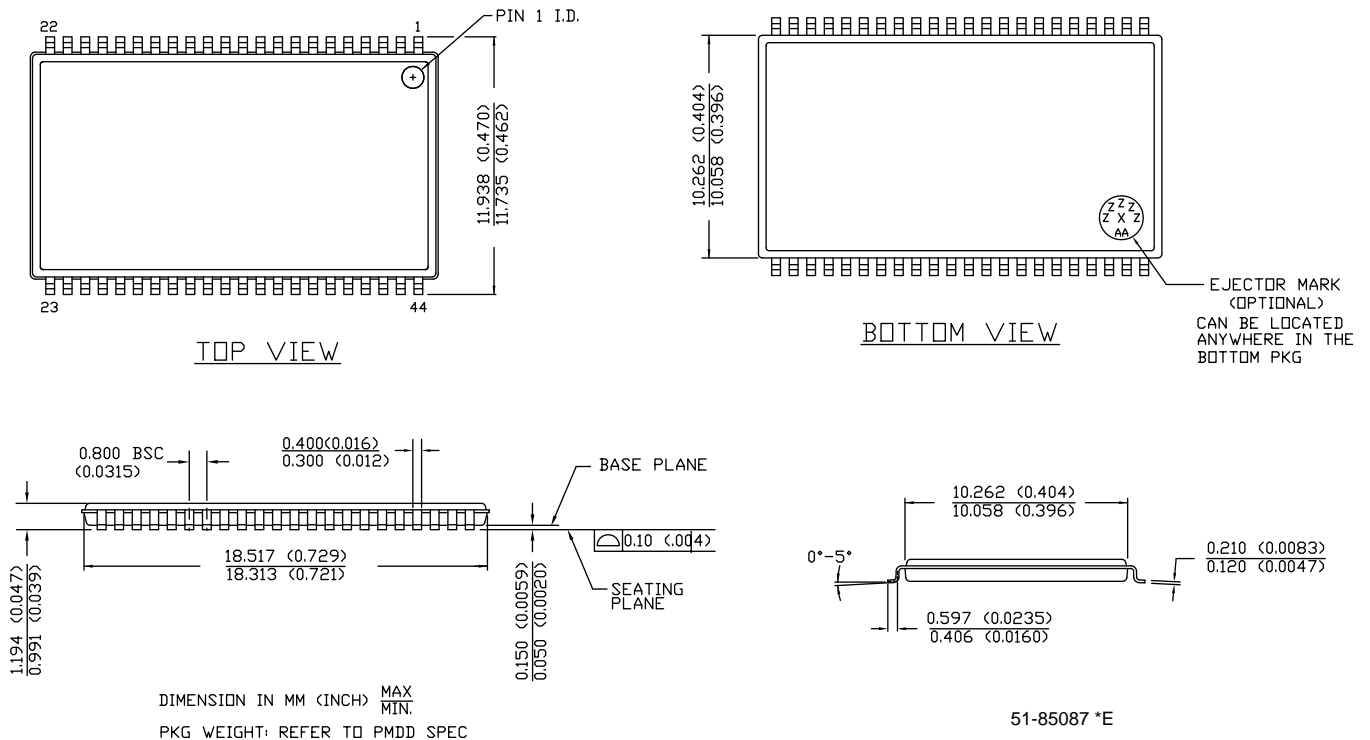

Figure 12. 44-pin TSOP Z44-II Package Outline, 51-85087



Acronyms

Table 1. Acronyms Used in this Document

| Acronym | Description |
|-------------------------|---|
| $\overline{\text{BHE}}$ | Byte High Enable |
| $\overline{\text{BLE}}$ | Byte Low Enable |
| $\overline{\text{CE}}$ | Chip Enable |
| CMOS | Complementary Metal Oxide Semiconductor |
| I/O | Input/Output |
| $\overline{\text{OE}}$ | Output Enable |
| SRAM | Static Random Access Memory |
| TSOP | Thin Small Outline Package |
| TTL | Transistor-Transistor Logic |
| VFBGA | Very Fine-Pitch Ball Grid Array |
| $\overline{\text{WE}}$ | Write Enable |

Document Conventions

Units of Measure

Table 2. Units of Measure

| Symbol | Unit of Measure |
|--------|-----------------|
| °C | degree Celsius |
| MHz | megahertz |
| μA | microampere |
| μs | microsecond |
| mA | milliampere |
| mm | millimeter |
| ns | nanosecond |
| Ω | ohm |
| % | percent |
| pF | picofarad |
| V | volt |
| W | watt |

Document History Page

| Document Title: CY7C1041G Automotive, 4-Mbit (256K words × 16 bit) Static RAM with Error-Correcting Code (ECC) | | | | |
|--|---------|-----------------|-----------------|--|
| Document Number: 001-91255 | | | | |
| Rev. | ECN No. | Orig. of Change | Submission Date | Description of Change |
| *F | 4996293 | NILE | 10/30/2015 | Changed status from Preliminary to Final. |
| *G | 5026902 | NILE | 11/25/2015 | Added Automotive-A Temperature Range related information in all instances across the document. Updated Ordering Information : Updated part numbers. |
| *H | 5427560 | NILE | 09/07/2016 | Updated Ordering Information : Updated part numbers. Added Tape and Reel ordering codes. Updated DC Electrical Characteristics : Enhanced V _{OH} for voltage range 3.0V to 3.6V from 2.2V to 2.4V. Updated Foot note 4. Updated Copyright and Disclaimer. |

Sales, Solutions, and Legal Information

Worldwide Sales and Design Support

Cypress maintains a worldwide network of offices, solution centers, manufacturer's representatives, and distributors. To find the office closest to you, visit us at [Cypress Locations](#).

Products

| | |
|-------------------------------|--|
| ARM® Cortex® Microcontrollers | cypress.com/arm |
| Automotive | cypress.com/automotive |
| Clocks & Buffers | cypress.com/clocks |
| Interface | cypress.com/interface |
| Internet of Things | cypress.com/iot |
| Lighting & Power Control | cypress.com/powerpsoc |
| Memory | cypress.com/memory |
| PSoC | cypress.com/psoc |
| Touch Sensing | cypress.com/touch |
| USB Controllers | cypress.com/usb |
| Wireless/RF | cypress.com/wireless |

PSoC® Solutions

[PSoC 1](#) | [PSoC 3](#) | [PSoC 4](#) | [PSoC 5LP](#)

Cypress Developer Community

[Forums](#) | [Projects](#) | [Video](#) | [Blogs](#) | [Training](#) | [Components](#)

Technical Support

cypress.com/support

© Cypress Semiconductor Corporation, 2014-2016. This document is the property of Cypress Semiconductor Corporation and its subsidiaries, including Spansion LLC ("Cypress"). This document, including any software or firmware included or referenced in this document ("Software"), is owned by Cypress under the intellectual property laws and treaties of the United States and other countries worldwide. Cypress reserves all rights under such laws and treaties and does not, except as specifically stated in this paragraph, grant any license under its patents, copyrights, trademarks, or other intellectual property rights. If the Software is not accompanied by a license agreement and you do not otherwise have a written agreement with Cypress governing the use of the Software, then Cypress hereby grants you a personal, non-exclusive, nontransferable license (without the right to sublicense) (1) under its copyright rights in the Software (a) for Software provided in source code form, to modify and reproduce the Software solely for use with Cypress hardware products, only internally within your organization, and (b) to distribute the Software in binary code form externally to end users (either directly or indirectly through resellers and distributors), solely for use on Cypress hardware product units, and (2) under those claims of Cypress's patents that are infringed by the Software (as provided by Cypress, unmodified) to make, use, distribute, and import the Software solely for use with Cypress hardware products. Any other use, reproduction, modification, translation, or compilation of the Software is prohibited.

TO THE EXTENT PERMITTED BY APPLICABLE LAW, CYPRESS MAKES NO WARRANTY OF ANY KIND, EXPRESS OR IMPLIED, WITH REGARD TO THIS DOCUMENT OR ANY SOFTWARE OR ACCOMPANYING HARDWARE, INCLUDING, BUT NOT LIMITED TO, THE IMPLIED WARRANTIES OF MERCHANTABILITY AND FITNESS FOR A PARTICULAR PURPOSE. To the extent permitted by applicable law, Cypress reserves the right to make changes to this document without further notice. Cypress does not assume any liability arising out of the application or use of any product or circuit described in this document. Any information provided in this document, including any sample design information or programming code, is provided only for reference purposes. It is the responsibility of the user of this document to properly design, program, and test the functionality and safety of any application made of this information and any resulting product. Cypress products are not designed, intended, or authorized for use as critical components in systems designed or intended for the operation of weapons, weapons systems, nuclear installations, life-support devices or systems, other medical devices or systems (including resuscitation equipment and surgical implants), pollution control or hazardous substances management, or other uses where the failure of the device or system could cause personal injury, death, or property damage ("Unintended Uses"). A critical component is any component of a device or system whose failure to perform can be reasonably expected to cause the failure of the device or system, or to affect its safety or effectiveness. Cypress is not liable, in whole or in part, and you shall and hereby do release Cypress from any claim, damage, or other liability arising from or related to all Unintended Uses of Cypress products. You shall indemnify and hold Cypress harmless from and against all claims, costs, damages, and other liabilities, including claims for personal injury or death, arising from or related to any Unintended Uses of Cypress products.

Cypress, the Cypress logo, Spansion, the Spansion logo, and combinations thereof, WICED, PSoC, CapSense, EZ-USB, F-RAM, and Traveo are trademarks or registered trademarks of Cypress in the United States and other countries. For a more complete list of Cypress trademarks, visit cypress.com. Other names and brands may be claimed as property of their respective owners.