

**CHIP COIL (CHIP INDUCTORS) LQW15AN□□□□0ZD**  
**Murata Standard Reference Specification 【AEC-Q200】**

**1. Scope**

This Reference specification applies to LQW15AN\_0ZD series, Chip coil(Chip Inductors) for automotive Electronics based on AEC-Q200 except for Power train and Safety.

**2. Part Numbering**

(ex)   LQ     W     15     A     N     1N5     B     0     Z     D    
 Product ID Structure Dimension Applications Category Inductance Tolerance Features Application Packaging  
 (L×W) and Characteristics Z:Automotive D:Taping

**3. Rating**

- Operating Temperature Range      -55°C ~ +125°C
- Storage Temperature Range.       -55°C ~ +125°C

Customer Part Number	MURATA Part Number	Inductance (*1) refer to below comment		Q (*1) (min.)	DC Resistance (*1) (Ω max.)	Self Resonant Frequency (*1) (GHz min.)	Rated Current (mA)	ESD Rank 6 : 25kV
		(nH)	Tolerance					
	LQW15AN1N5B0ZD	1.5	B:±0.1nH C:±0.2nH D:±0.5nH	10	0.03	18.0	1000	
	LQW15AN1N5C0ZD							
	LQW15AN1N5D0ZD							
	LQW15AN1N6C0ZD	1.6	C:±0.2nH D:±0.5nH		0.07	17	750	
	LQW15AN1N6D0ZD							
	LQW15AN1N7C0ZD	1.7						
	LQW15AN1N7D0ZD							
	LQW15AN1N8C0ZD	1.8		0.16	16	460		
	LQW15AN1N8D0ZD							
	LQW15AN2N4B0ZD	2.4	B:±0.1nH C:±0.2nH D:±0.5nH				20	0.05
	LQW15AN2N4C0ZD							
	LQW15AN2N4D0ZD							
	LQW15AN2N5B0ZD	2.5						
	LQW15AN2N5C0ZD							
	LQW15AN2N5D0ZD							
	LQW15AN2N6B0ZD	2.6	0.07	750				
	LQW15AN2N6C0ZD							
	LQW15AN2N6D0ZD							
	LQW15AN2N7B0ZD	2.7	0.13	570				
	LQW15AN2N7C0ZD							
	LQW15AN2N7D0ZD							
	LQW15AN2N8B0ZD	2.8	0.17	500				
	LQW15AN2N8C0ZD							
	LQW15AN2N8D0ZD							
	LQW15AN2N9B0ZD	2.9	0.07	750				
	LQW15AN2N9C0ZD							
	LQW15AN2N9D0ZD							
	LQW15AN3N0B0ZD	3.0	0.13	570				
	LQW15AN3N0C0ZD							
	LQW15AN3N0D0ZD							
	LQW15AN3N1B0ZD	3.1	0.17	500				
	LQW15AN3N1C0ZD							
	LQW15AN3N1D0ZD							
	LQW15AN3N2B0ZD	3.2	0.07	750				
	LQW15AN3N2C0ZD							
	LQW15AN3N2D0ZD							
	LQW15AN3N9B0ZD	3.9	0.07	10.0	750			
	LQW15AN3N9C0ZD							
	LQW15AN3N9D0ZD							

Customer Part Number	MURATA Part Number	Inductance (*1) refer to below comment		Q (*1) (min.)	DC Resistance (*1) (Ω max.)	Self Resonant Frequency (*1) (GHz min.)	Rated Current (mA)	ESD Rank 6 : 25kV
		(nH)	Tolerance					
	LQW15AN4N1B0ZD	4.1		25	0.07	10.0	750	6
	LQW15AN4N1C0ZD							
	LQW15AN4N1D0ZD							
	LQW15AN4N3B0ZD	4.3		25	0.07	8.0	600	6
	LQW15AN4N3C0ZD							
	LQW15AN4N3D0ZD							
	LQW15AN4N4B0ZD	4.4		25	0.07	8.0	600	6
	LQW15AN4N4C0ZD							
	LQW15AN4N4D0ZD							
	LQW15AN4N5B0ZD	4.5		25	0.07	8.0	600	6
	LQW15AN4N5C0ZD							
	LQW15AN4N5D0ZD							
	LQW15AN4N6B0ZD	4.6		25	0.07	8.0	600	6
	LQW15AN4N6C0ZD							
	LQW15AN4N6D0ZD							
	LQW15AN4N7B0ZD	4.7		25	0.07	8.0	600	6
	LQW15AN4N7C0ZD							
	LQW15AN4N7D0ZD							
	LQW15AN4N8B0ZD	4.8		25	0.07	8.0	600	6
	LQW15AN4N8C0ZD							
	LQW15AN4N8D0ZD							
	LQW15AN4N9B0ZD	4.9		25	0.07	8.0	600	6
	LQW15AN4N9C0ZD							
	LQW15AN4N9D0ZD							
	LQW15AN5N0B0ZD	5.0	B:±0.1nH C:±0.2nH D:±0.5nH	25	0.12	8.0	600	6
	LQW15AN5N0C0ZD							
	LQW15AN5N0D0ZD							
	LQW15AN5N1B0ZD	5.1		25	0.12	8.0	600	6
	LQW15AN5N1C0ZD							
	LQW15AN5N1D0ZD							
	LQW15AN5N8B0ZD	5.8		25	0.09	6.0	700	6
	LQW15AN5N8C0ZD							
	LQW15AN5N8D0ZD							
	LQW15AN6N2B0ZD	6.2		25	0.09	6.0	700	6
	LQW15AN6N2C0ZD							
	LQW15AN6N2D0ZD							
	LQW15AN6N3B0ZD	6.3		25	0.09	6.0	700	6
	LQW15AN6N3C0ZD							
	LQW15AN6N3D0ZD							
	LQW15AN6N4B0ZD	6.4		25	0.09	6.0	700	6
	LQW15AN6N4C0ZD							
	LQW15AN6N4D0ZD							
	LQW15AN6N5B0ZD	6.5		25	0.09	6.0	700	6
	LQW15AN6N5C0ZD							
	LQW15AN6N5D0ZD							
	LQW15AN6N6B0ZD	6.6		25	0.09	6.0	700	6
	LQW15AN6N6C0ZD							
	LQW15AN6N6D0ZD							
	LQW15AN6N7B0ZD	6.7		25	0.09	6.0	700	6
	LQW15AN6N7C0ZD							
	LQW15AN6N7D0ZD							
	LQW15AN6N8G0ZD	6.8	G:±2% H:±3% J:±5%	25	0.09	6.0	700	6
	LQW15AN6N8H0ZD							
	LQW15AN6N8J0ZD							

Customer Part Number	MURATA Part Number	Inductance (*1) refer to below comment		Q (*1) (min.)	DC Resistance (*1) (Ω max.)	Self Resonant Frequency (*1) (GHz min.)	Rated Current (mA)	ESD Rank 6 : 25kV
		(nH)	Tolerance					
	LQW15AN6N9G0ZD	6.9	G:±2% H:±3% J:±5%	25	0.13	6.0	570	6
	LQW15AN6N9H0ZD							
	LQW15AN6N9J0ZD							
	LQW15AN7N0G0ZD	7.0						
	LQW15AN7N0H0ZD							
	LQW15AN7N0J0ZD							
	LQW15AN7N1G0ZD	7.1						
	LQW15AN7N1H0ZD							
	LQW15AN7N1J0ZD							
	LQW15AN7N2G0ZD	7.2						
	LQW15AN7N2H0ZD							
	LQW15AN7N2J0ZD							
	LQW15AN7N3G0ZD	7.3						
	LQW15AN7N3H0ZD							
	LQW15AN7N3J0ZD							
	LQW15AN7N5G0ZD	7.5						
	LQW15AN7N5H0ZD							
	LQW15AN7N5J0ZD							
	LQW15AN8N2G0ZD	8.2						
	LQW15AN8N2H0ZD							
	LQW15AN8N2J0ZD							
	LQW15AN8N6G0ZD	8.6						
	LQW15AN8N6H0ZD							
	LQW15AN8N6J0ZD							
	LQW15AN8N7G0ZD	8.7						
	LQW15AN8N7H0ZD							
	LQW15AN8N7J0ZD							
	LQW15AN8N8G0ZD	8.8						
	LQW15AN8N8H0ZD							
	LQW15AN8N8J0ZD							
	LQW15AN8N9G0ZD	8.9						
	LQW15AN8N9H0ZD							
	LQW15AN8N9J0ZD							
	LQW15AN9N0G0ZD	9.0						
	LQW15AN9N0H0ZD							
	LQW15AN9N0J0ZD							
	LQW15AN9N1G0ZD	9.1						
	LQW15AN9N1H0ZD							
	LQW15AN9N1J0ZD							
	LQW15AN9N2G0ZD	9.2						
	LQW15AN9N2H0ZD							
	LQW15AN9N2J0ZD							
	LQW15AN9N3G0ZD	9.3						
	LQW15AN9N3H0ZD							
	LQW15AN9N3J0ZD							
	LQW15AN9N4G0ZD	9.4						
	LQW15AN9N4H0ZD							
	LQW15AN9N4J0ZD							
	LQW15AN9N5G0ZD	9.5						
	LQW15AN9N5H0ZD							
	LQW15AN9N5J0ZD							
	LQW15AN9N6G0ZD	9.6						
	LQW15AN9N6H0ZD							
	LQW15AN9N6J0ZD							

Customer Part Number	MURATA Part Number	Inductance (*1) refer to below comment		Q (*1) (min.)	DC Resistance (*1) (Ω max.)	Self Resonant Frequency (*1) (GHz min.)	Rated Current (mA)	ESD Rank 6 : 25kV
		(nH)	Tolerance					
	LQW15AN9N7G0ZD	9.7	G:±2% H:±3% J:±5%	25	0.14	5.5	540	6
	LQW15AN9N7H0ZD							
	LQW15AN9N7J0ZD							
	LQW15AN9N8G0ZD							
	LQW15AN9N8H0ZD							
	LQW15AN9N8J0ZD							
	LQW15AN9N9G0ZD	9.9						
	LQW15AN9N9H0ZD							
	LQW15AN9N9J0ZD							
	LQW15AN10NG0ZD	10						
	LQW15AN10NH0ZD							
	LQW15AN10NJ0ZD							
	LQW15AN11NG0ZD	11						
	LQW15AN11NH0ZD							
	LQW15AN11NJ0ZD							
	LQW15AN12NG0ZD	12						
	LQW15AN12NH0ZD							
	LQW15AN12NJ0ZD							
	LQW15AN13NG0ZD	13						
	LQW15AN13NH0ZD							
	LQW15AN13NJ0ZD							
	LQW15AN15NG0ZD	15						
	LQW15AN15NH0ZD							
	LQW15AN15NJ0ZD							
	LQW15AN16NG0ZD	16						
	LQW15AN16NH0ZD							
	LQW15AN16NJ0ZD							
	LQW15AN18NG0ZD	18						
	LQW15AN18NH0ZD							
	LQW15AN18NJ0ZD							
	LQW15AN19NG0ZD	19						
	LQW15AN19NH0ZD							
	LQW15AN19NJ0ZD							
	LQW15AN20NG0ZD	20						
	LQW15AN20NH0ZD							
	LQW15AN20NJ0ZD							
	LQW15AN22NG0ZD	22						
	LQW15AN22NH0ZD							
	LQW15AN22NJ0ZD							
	LQW15AN23NG0ZD	23						
	LQW15AN23NH0ZD							
	LQW15AN23NJ0ZD							
	LQW15AN24NG0ZD	24						
	LQW15AN24NH0ZD							
	LQW15AN24NJ0ZD							
	LQW15AN27NG0ZD	27						
	LQW15AN27NH0ZD							
	LQW15AN27NJ0ZD							
	LQW15AN30NG0ZD	30						
	LQW15AN30NH0ZD							
	LQW15AN30NJ0ZD							
	LQW15AN33NG0ZD	33						
	LQW15AN33NH0ZD							
	LQW15AN33NJ0ZD							

Customer Part Number	MURATA Part Number	Inductance (*1) refer to below comment		Q (*1) (min.)	DC Resistance (*1) (Ω max.)	Self Resonant Frequency (*1) (GHz min.)	Rated Current (mA)	ESD Rank 6 : 25kV			
		(nH)	Tolerance								
	LQW15AN36NG0ZD LQW15AN36NH0ZD LQW15AN36NJ0ZD	36	G:±2% H:±3% J:±5%	25	0.63	3.1	260	6			
	LQW15AN39NG0ZD LQW15AN39NH0ZD LQW15AN39NJ0ZD	39			0.70	3.0	250				
	LQW15AN40NG0ZD LQW15AN40NH0ZD LQW15AN40NJ0ZD	40									
	LQW15AN43NG0ZD LQW15AN43NH0ZD LQW15AN43NJ0ZD	43									
	LQW15AN47NG0ZD LQW15AN47NH0ZD LQW15AN47NJ0ZD	47							1.08	2.9	210
	LQW15AN51NG0ZD LQW15AN51NH0ZD LQW15AN51NJ0ZD	51							2.85		
	LQW15AN56NG0ZD LQW15AN56NH0ZD LQW15AN56NJ0ZD	56							1.17	2.8	200
	LQW15AN62NG0ZD LQW15AN62NH0ZD LQW15AN62NJ0ZD	62			1.82	2.6	145				
	LQW15AN68NG0ZD LQW15AN68NJ0ZD	68			1.96	2.5	140				
	LQW15AN72NG0ZD LQW15AN72NJ0ZD	72			2.10		2.4		135		
	LQW15AN75NG0ZD LQW15AN75NJ0ZD	75									
	LQW15AN82NG0ZD LQW15AN82NJ0ZD	82			2.24	2.3	130				
	LQW15AN91NG0ZD LQW15AN91NJ0ZD	91	2.38	2.1	125						
	LQW15ANR10J0ZD	100	J:±5%	2.52	1.5	120					
	LQW15ANR12J0ZD	120		2.66	1.0	110					

(\*1)

## 4. Testing Conditions

《Unless otherwise specified》

Temperature : Ordinary Temperature / 15°C to 35°C  
Humidity : Ordinary Humidity / 25%(RH) to 85%(RH)

《In case of doubt》

Temperature : 20°C±2°C  
Humidity : 60%(RH) to 70%(RH)  
Atmospheric Pressure : 86kPa to 106 kPa

## 5. Appearance and Dimensions

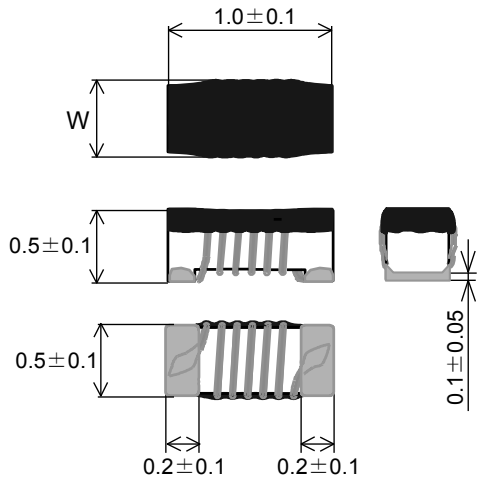

\*Dimension of W

Inductance	W (in mm)
1N5~23N	$0.6 \pm 0.1$
24N~R12	$0.5 \pm 0.1$

■ Unit mass (Typical value)

0.0008g

(in mm)

## 6. Electrical Performance

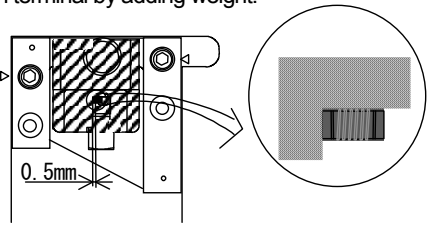
No.	Item	Specification	Test Method
6.1	Inductance	Inductance shall meet item 3.	Measuring Equipment : KEYSIGHT E4991A or equivalent Measuring Frequency : <Inductance> 100MHz <Q> 250MHz / 1.5nH~ 43nH 200MHz / 47nH~ 68nH 150MHz / 72nH~120nH  Measuring Condition : Test signal level / about 0dBm Electrical length / 0.94cm Measuring Fixture : KEYSIGHT 16193A  Position coil under test as shown in below and contact coil with each terminal by adding weight.
6.2	Q	Q shall meet item 3.	 <p>The diagram shows a cross-section of a measuring fixture with a coil placed inside. A dimension line indicates a width of 0.5mm. An inset shows a top-down view of the coil.</p> Measuring Method : See the endnote. <Electrical Performance : Measuring Method of Inductance/Q>
6.3	DC Resistance	DC Resistance shall meet item 3.	Measuring Equipment : Digital multi meter
6.4	Self Resonant Frequency(S.R.F)	S.R.F shall meet item 3.	Measuring Equipment : KEYSIGHT N5230A or equivalent
6.5	Rated Current	Self temperature rise shall be limited to 20°C max.	The rated current is applied.

## 7. Q200 Requirement

## 7.1.Performance (based on Table 5 for Magnetics(Inductors / Transformer)

## AEC-Q200 Rev.D issued June 1. 2010

AEC-Q200			Murata Specification / Deviation				
No	Stress	Test Method					
3	High Temperature Exposure	1000hours at 125 deg C Set for 24hours at room temperature, then measured.	Meet Table A after testing. Table A <table border="1"> <tr> <td>Appearance</td> <td>No damage</td> </tr> <tr> <td>Inductance change (at 100MHz)</td> <td>Within <math>\pm 5\%</math></td> </tr> </table>	Appearance	No damage	Inductance change (at 100MHz)	Within $\pm 5\%$
Appearance	No damage						
Inductance change (at 100MHz)	Within $\pm 5\%$						
4	Temperature Cycling	1000cycles -40 deg C to +125 deg C Set for 24hours at room temperature, then measured.	Meet Table A after testing.				
7	Biased Humidity	1000hours at 85 deg C, 85%RH unpowered..	Meet Table A after testing.				
8	Operational Life	Apply 125 deg C 1000hours Set for 24hours at room temperature, then measured	Meet Table A after testing.				
9	External Visual	Visual inspection	No abnormalities				
10	Physical Dimension	Meet ITEM 5 (Style and Dimensions)	No defects				
12	Resistance to Solvents	Per MIL-STD-202 Method 215	Not Applicable				
13	Mechanical Shock	Per MIL-STD-202 Method 213 Condition C : 100g's(0.98N), 6ms, Half sine, 12.3ft / s	Meet Table A after testing.				
14	Vibration	5g's(0.049N) for 20 minutes, 12cycles each of 3 orientations Test from 10-2000Hz.	Meet Table A after testing.				
15	Resistance to Soldering Heat	No-heating Solder temperature 260C $\pm$ 5 deg C Immersion time 10s	Pre-heating: 150C + / -10 deg C, 60s to 90s Meet Table A after testing.				
17	ESD	Per AEC-Q200-002	ESD Rank: Refer to Item 3. Rating. Meet Table A after testing				
18	Solderability	Per J-STD-002	Method b : Not Applicable 95% of the terminations is to be soldered. (Except exposed wire)				
19	Electrical Characterization	Measured : Inductance	No defects				
20	Flammability	Per UL-94	Not Applicable				

AEC-Q200			Murata Specification / Deviation				
No	Stress	Test Method					
21	Board Flex	Epoxy-PCB(1.6mm) Deflection 2mm(min) Holding time 60s	Meet Table B after testing. Table B <table border="1" style="margin-left: 20px;"> <tr> <td>Appearance</td> <td>No damage</td> </tr> <tr> <td>DC resistance change</td> <td>Within ±10%</td> </tr> </table>	Appearance	No damage	DC resistance change	Within ±10%
Appearance	No damage						
DC resistance change	Within ±10%						
22	Terminal Strength	Per AEC-Q200-006 A force of 17.7N for 60s	No defects Murata Deviation Request: 5N / 60s				

8. Specification of Packaging

8.1 Appearance and Dimensions of paper tape (8mm-wide)

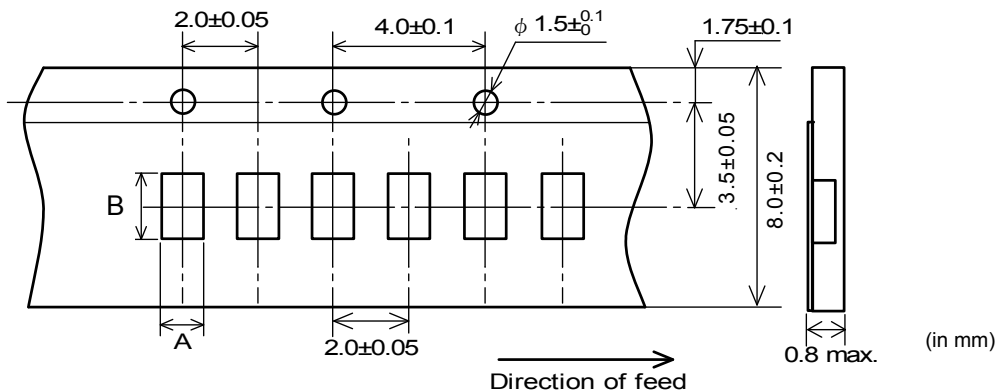

Inductance	A* (mm) (Tolerance ±0.03)	B* (mm) (Tolerance ±0.03)
1N5, 2N4~2N8, 3N9~4N8, 5N8~6N8, 8N2~9N9, 11N, 12N, 15N	0.69	1.18
1N6~1N8, 2N9, 3N0, 3N1, 3N2, 4N9~5N1, 6N9-7N5, 10N, 13N, 16N~23N, R10, R12	0.66	1.18
24N~91N	0.64	1.18

\*Typical value

8.2 Specification of Taping

- (1) Packing quantity (standard quantity)  
10,000 pcs. / reel
- (2) Packing Method  
Products shall be packed in the cavity of the base tape and sealed by Cover tape.
- (3) Sprocket hole  
The sprocket holes are to the right as the tape is pulled toward the user.
- (4) Spliced point  
Base tape and Cover tape has no spliced point.
- (5) Missing components number  
Missing components number within 0.1% of the number per reel or 1 pc., whichever is greater, and are not continuous. The Specified quantity per reel is kept.

8.3 Pull Strength

Cover tape	5N min.
------------	---------

8.4 Peeling off force of cover tape

Speed of Peeling off	300mm/min
Peeling off force	0.1N to 0.6N (minimum value is typical)

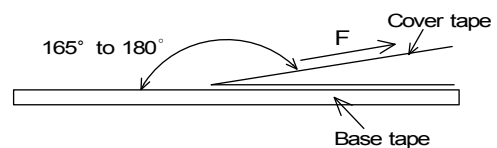



**8.5 Dimensions of Leader-tape,Trailer and Reel**

There shall be leader-tape (cover tape and empty tape) and trailer-tape (empty tape) as follows.

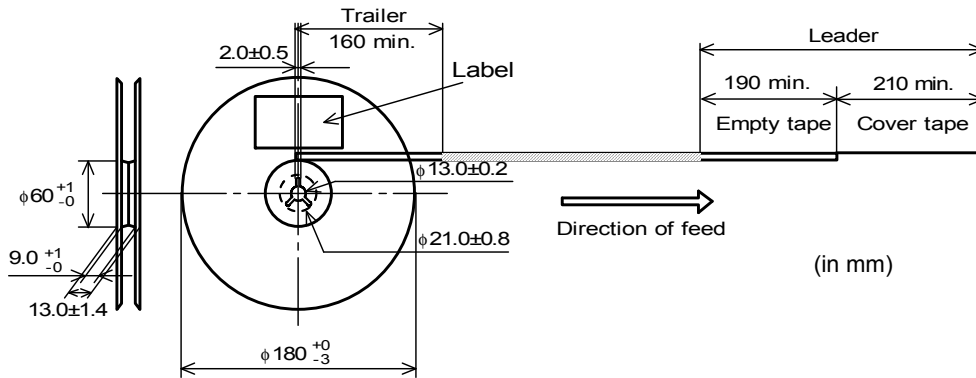

**8.6 Marking for reel**

Customer part number, MURATA part number, Inspection number(\*1), RoHS marking(\*2), Quantity etc ...

\*1) <Expression of Inspection No.>  $\square\square\ 0000\ xxx$   
 (1) (2) (3)

(1) Factory Code

(2) Date  
 First digit : Year / Last digit of year  
 Second digit : Month / Jan. to Sep. → 1 to 9, Oct. to Dec. → O, N, D  
 Third, Fourth digit : Day

(3) Serial No.

\*2) « Expression of RoHS marking » ROHS -  $\underline{Y}(\underline{\Delta})$   
 (1) (2)

(1) RoHS regulation conformity

(2) MURATA classification number

**8.7 Marking for Outside package (corrugated paper box)**

Customer name, Purchasing order number, Customer part number, MURATA part number, RoHS Marking (\*2), Quantity, etc ...

**8.8. Specification of Outer Case**

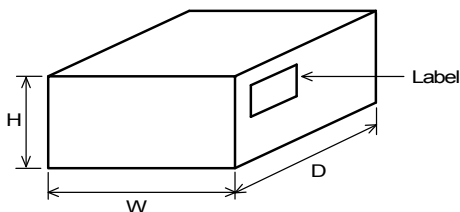

Outer Case Dimensions (mm)			Standard Reel Quantity in Outer Case (Reel)
W	D	H	
186	186	93	5

\* Above Outer Case size is typical. It depends on a quantity of an order.

**9. ⚠ Caution**

**Limitation of Applications**

Please contact us before using our products for the applications listed below which require especially high reliability for the prevention of defects which might directly cause damage to the third party's life, body or property.

- (1) Aircraft equipment
- (2) Aerospace equipment
- (3) Undersea equipment
- (4) Power plant control equipment
- (5) Medical equipment
- (6) Transportation equipment (trains, ships, etc.)
- (7) Traffic signal equipment
- (8) Disaster prevention / crime prevention equipment
- (9) Data-processing equipment
- (10) Applications of similar complexity and /or reliability requirements to the applications listed in the above

**10. Notice**

Products can only be soldered with reflow.  
 This product is designed for solder mounting.  
 Please consult us in advance for applying other mounting method such as conductive adhesive.

**10.1 Land pattern designing**

Recommended land patterns for reflow soldering are as follows:  
 These have been designed for Electric characteristics and solderability.  
 Please follow the recommended patterns. Otherwise, their performance which includes electrical performance or solderability may be affected, or result to "position shift" in soldering process.

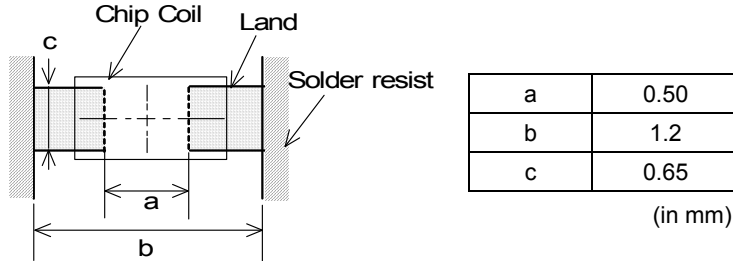

**10.2 Flux, Solder**

- Use rosin-based flux.  
 Includes middle activator equivalent to 0.06(wt)% to 0.1(wt) % Chlorine.  
 Don't use highly acidic flux with halide content exceeding 0.2(wt) % (chlorine conversion value).  
 Don't use water-soluble flux.
- Use Sn-3.0Ag-0.5Cu solder.
- Standard thickness of solder paste : 100 μm to 150 μm.

**10.3 Reflow soldering conditions**

- Pre-heating should be in such a way that the temperature difference between solder and product surface is limited to 150°C max. Cooling into solvent after soldering also should be in such a way that the temperature difference is limited to 100°C max.  
 Insufficient pre-heating may cause cracks on the product, resulting in the deterioration of products quality.
- Standard soldering profile and the limit soldering profile is as follows.  
 The excessive limit soldering conditions may cause leaching of the electrode and / or resulting in the deterioration of product quality.
- Reflow soldering profile

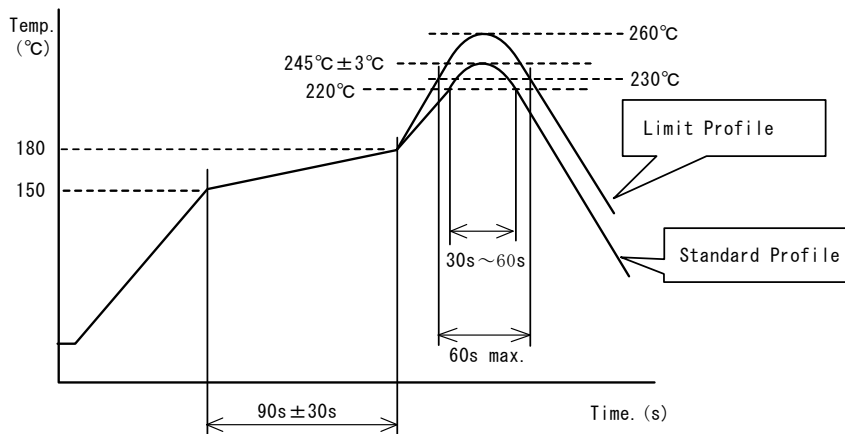

	Standard Profile	Limit Profile
Pre-heating	150°C~180°C , 90s±30s	
Heating	above 220°C, 30s~60s	above 230°C, 60s max.
Peak temperature	245°C±3°C	260°C, 10s
Cycle of reflow	2 times	2 times

**10.4 Reworking with soldering iron**

The following conditions must be strictly followed when using a soldering iron.

Pre-heating	150°C, 1 min
Tip temperature	350°C max.
Soldering iron output	80W max.
Tip diameter	φ3mm max.
Soldering time	3(+1,-0)s
Time	2 times

Note: Do not directly touch the products with the tip of the soldering iron in order to prevent the crack on the products due to the thermal shock.

**10.5 Solder Volume**

- Solder shall be used not to be exceeded the upper limits as shown below.
- Accordingly increasing the solder volume, the mechanical stress to Chip is also increased. Exceeding solder volume may cause the failure of mechanical or electrical performance.

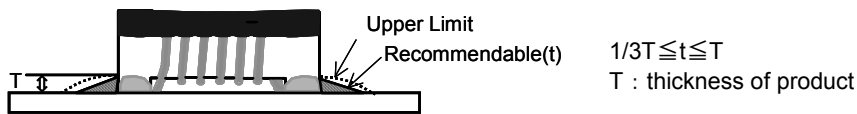

**10.6 Product's location**

The following shall be considered when designing and laying out P.C.B.'s.

- (1) P.C.B. shall be designed so that products are not subject to the mechanical stress due to warping the board.

[Products direction]

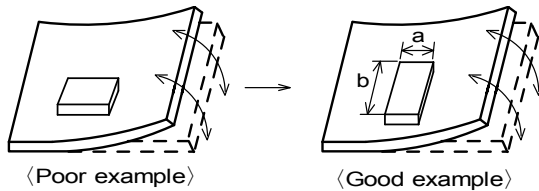

Products shall be located in the sideways direction (Length: a < b) to the mechanical stress.

- (2) Components location on P.C.B. separation.

It is effective to implement the following measures, to reduce stress in separating the board.

It is best to implement all of the following three measures; however, implement as many measures as possible to reduce stress.

Contents of Measures	Stress Level
(1) Turn the mounting direction of the component parallel to the board separation surface.	A > D *1
(2) Add slits in the board separation part.	A > B
(3) Keep the mounting position of the component away from the board separation surface.	A > C

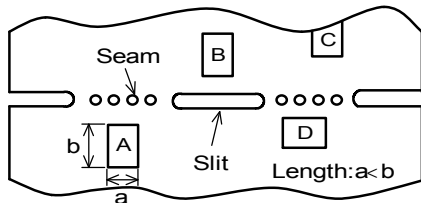

\*1 A > D is valid when stress is added vertically to the perforation as with Hand Separation. If a Cutting Disc is used, stress will be diagonal to the PCB, therefore A > D is invalid.

- (3) Mounting Components Near Screw Holes

When a component is mounted near a screw hole, it may be affected by the board deflection that occurs during the tightening of the screw. Mount the component in a position as far away from the screw holes as possible.

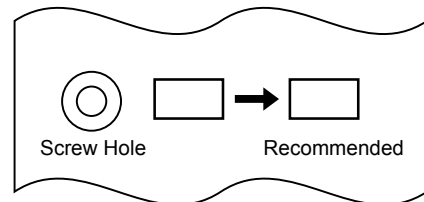

**10.7 Cleaning Conditions**

Products shall be cleaned on the following conditions.

- (1) Cleaning temperature shall be limited to 60°C max.(40°C max for IPA)
- (2) Ultrasonic cleaning shall comply with the following conditions with avoiding the resonance phenomenon at the mounted products and P.C.B.  
Power : 20 W / l max.      Frequency : 28kHz to 40kHz      Time : 5 min max.
- (3) Cleaner
  1. Alcohol type cleaner  
Isopropyl alcohol (IPA)
  2. Aqueous agent  
PINE ALPHA ST-100S
- (4) There shall be no residual flux and residual cleaner after cleaning.  
In the case of using aqueous agent, products shall be dried completely after rinse with de-ionized water in order to remove the cleaner.
- (5) Other cleaning      Please contact us.

**10.8 Resin coating**

The inductance value may change due to high cure-stress of resin to be used for coating/molding products.

An open circuit issue may occur by mechanical stress caused by the resin, amount/cured shape of resin, or operating condition etc. Some resin contains some impurities or chloride possible to generate chlorine by hydrolysis under some operating condition may cause corrosion of wire of coil, leading to open circuit. So, please pay your careful attention when you select resin in case of coating/molding the products with the resin.

Prior to use the coating resin, please make sure no reliability issue is observed by evaluating products mounted on your board.

**10.9 Caution for use**

- Sharp material such as a pair of tweezers or other material such as bristles of cleaning brush , shall not be touched to the winding portion to prevent the breaking of wire.
- Mechanical shock should not be applied to the products mounted on the board to prevent the breaking of the core.

**10.10 Notice of product handling at mounting**

In some mounting machines,when picking up components support pin pushes up the components from the bottom of base tape. In this case, please remove the support pin. The support pin may damage the components and break wire.

In rare case ,the laser recognition can not recognize this component. Please contact us when you use laser recognition. (There is no problem with the permeation and reflection type.)

**10.11 Handling of a substrate**

After mounting products on a substrate, do not apply any stress to the product caused by bending or twisting to the substrate when cropping the substrate, inserting and removing a connector from the substrate or tightening screw to the substrate.

Excessive mechanical stress may cause cracking in the product.

Bending

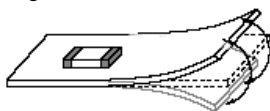

Twisting

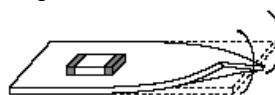
**10.12 Storage and Handling Requirements****(1) Storage period**

Use the products within 12 months after delivered.

Solderability should be checked if this period is exceeded.

**(2) Storage conditions**

- Products should be stored in the warehouse on the following conditions.

Temperature : -10°C to 40°C

Humidity : 15% to 85% relative humidity      No rapid change on temperature and humidity

- Don't keep products in corrosive gases such as sulfur, chlorine gas or acid, or it may cause oxidization of electrode, resulting in poor solderability.
- Products should not be stored on bulk packaging condition to prevent the chipping of the core and the breaking of winding wire caused by the collision between the products.
- Products should be stored on the palette for the prevention of the influence from humidity, dust and so on.
- Products should be stored in the warehouse without heat shock, vibration, direct sunlight and so on.

**(3) Handling Condition**

Care should be taken when transporting or handling product to avoid excessive vibration or mechanical shock.

**11. ⚠ Note**

- (1) Please make sure that your product has been evaluated in view of your specifications with our product being mounted to your product.
- (2) You are requested not to use our product deviating from the reference specifications.
- (3) The contents of this reference specification are subject to change without advance notice.  
Please approve our product specifications or transact the approval sheet for product specifications before ordering.

**< Electrical Performance: Measuring Method of Inductance/Q >**

(1) Residual elements and stray elements of test fixture can be described by F-parameter shown in following.

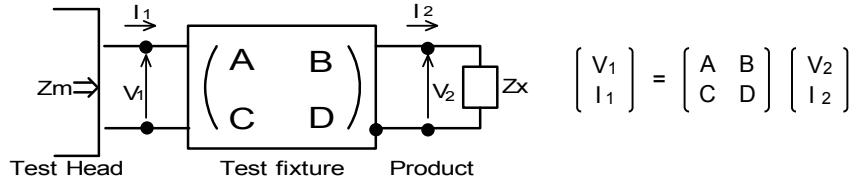

(2) The impedance of chip coil  $Z_x$  and measured value  $Z_m$  can be described by input/output current/voltage.

$$Z_m = \frac{V_1}{I_1}, \quad Z_x = \frac{V_2}{I_2}$$

(3) Thus, the relation between  $Z_x$  and  $Z_m$  is following;

$$Z_x = \alpha \frac{Z_m - \beta}{1 - Z_m \Gamma} \quad \text{where, } \alpha = D / A = 1$$

$$\beta = B / D = Z_{sm} - (1 - Y_{om} Z_{sm}) Z_{ss}$$

$$\Gamma = C / A = Y_{om}$$

- $Z_{sm}$  : measured impedance of short chip
- $Z_{ss}$  : residual impedance of short chip (0.556nH)
- $Y_{om}$  : measured admittance when opening the fixture

(4)  $L_x$  and  $Q_x$  shall be calculated with the following equation.

$$L_x = \frac{\text{Im}(Z_x)}{2\pi f}, \quad Q_x = \frac{\text{Im}(Z_x)}{\text{Re}(Z_x)}$$

$L_x$  : Inductance of chip coil  
 $Q_x$  : Q of chip coil  
 $f$  : Measuring frequency