

# User Guide

## Sentrius RG1xx

*Version 2.0*

---

## REVISION HISTORY

Version	Date	Notes	Approver
1.0	20 July	Initial Release	Jonathan Kaye
1.1	3 Aug 2017	Clarified web interface URL. Identified separate mDNS address.	Shewan Yitayew
1.2	29 Nov 2017	Update info for compatibility with GA2 (93.7.2.x) firmware. Add compliance information. Add IP67 Rated Version Specs	Jonathan Kaye
2.0	13 Dec 2017	Changed rev # to 2.0 to match engineering release	Jonathan Kaye

## CONTENTS

1	About this Guide.....	4
2	Introduction.....	4
2.1	Product Overview.....	4
2.2	Specification.....	5
3	Connecting the Hardware.....	9
3.1	Connect the Gateway.....	9
4	Log into the Gateway.....	10
5	LAN Connection Setup.....	13
5.1	IPv4 Configuration.....	13
5.2	IPv6 Configuration.....	13
5.3	Advanced View.....	14
6	Wi-Fi Connection Setup.....	15
6.1	Use Scan to Add a Profile.....	15
6.2	Manually Adding a Profile.....	16
6.3	Wi-Fi Advanced Page.....	17
7	LoRa Connection Setup.....	18
7.1	Using Presets.....	18
7.2	Forwarder.....	19
7.3	Radios.....	20
7.4	Advanced Configuration.....	23
7.5	Traffic.....	24
8	Manage the Gateway.....	25
8.1	Changing Username and Password.....	25
8.2	Version Information.....	26
8.3	Updating Gateway Firmware.....	26
8.4	Save/Restore Settings.....	28
8.5	Debug.....	28
8.6	Factory Reset.....	29
8.7	Bluetooth.....	29
8.8	Additional information:.....	29
9	IP67 Rated Enclosure.....	30
9.1	Specification.....	31
9.2	LED Display Reference.....	32
9.3	Cable Assemblies.....	33
9.4	Mounting Hardware.....	35
10	FCC and ISED Canada Regulatory Statements.....	37
10.1	Power Exposure Information.....	37
10.2	OEM Responsibilities.....	37
11	CE Regulatory.....	39
12	EU Declarations of Conformity (Update when ICC testing done).....	39

## 1 ABOUT THIS GUIDE

This document is the parent guide of the *RG1xx Quick Start Guide* and provides a comprehensive guide on how to configure the Sentrius RG186 and RG191 gateways to suit the intended application. It covers all the Sentrius RG1xx functionality, including Ethernet, Wi-Fi and LoRa configurations. It also provides instructions for setting up the gateway on a LoRa network server.

---

**Note:** Step-by-step instruction, screen shots, and pictures are based on the Sentrius RG191, but the same is applicable for the Sentrius RG186; differences are highlighted in the notes.

---

## 2 INTRODUCTION

### 2.1 Product Overview

Laird's Sentrius™ RG1xx LoRa-Enabled Gateway is the ultimate in secure, scalable, robust LoRa solutions for end-to-end control of your private LoRaWAN network. Leveraging Laird's field-proven and reliable 50 Series *Wireless Bridge* certified module, it also offers enterprise dual-band Wi-Fi, BT v4.0 (BLE and Classic), and wired Ethernet for complete design freedom. Based on the Semtech SX1301/SX1257 chipset designs, it offers a LoRa range up to ten miles and pre-loaded LoRa Packet Forwarder software, perfect for highly scalable, flexible IoT networks. The Sentrius RG1xx Gateway works with Laird's Sentrius RM1xx Series LoRa+BLE certified modules for simple out-of-the-box integration and is compatible with third-party cloud and LoRa partners, as well as any LoRaWAN-certified client devices.



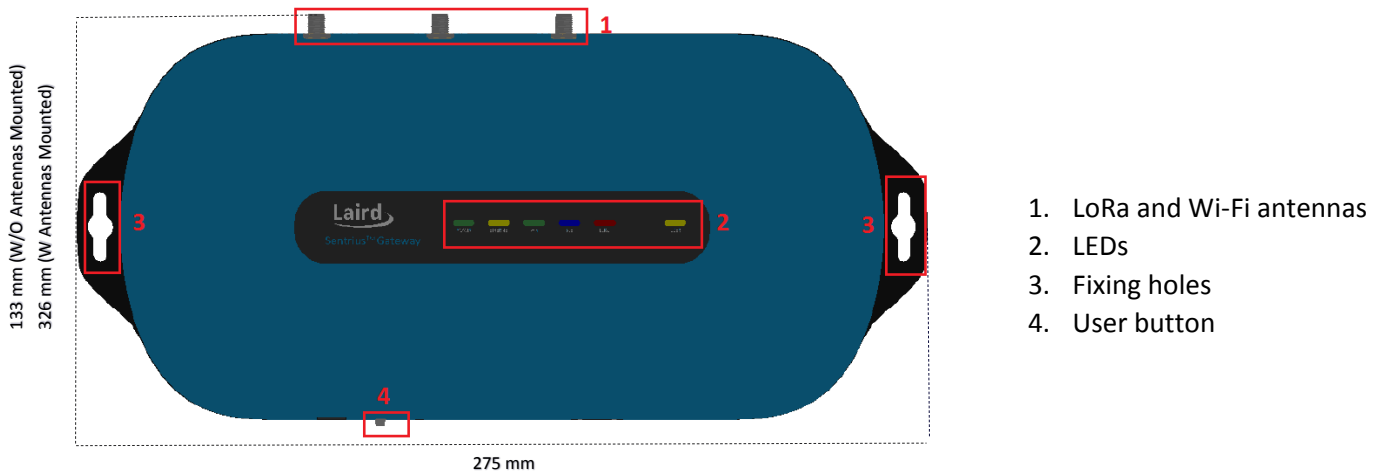

Figure 1: Top of the Sentrius™ RG1xx gateway



Figure 2: Side panel of the Sentrius™ RG1xx gateway

1. LoRa and Wi-Fi antennas
2. LEDs
3. Fixing holes
4. User button

5. DC power input
6. User button
7. Reset button
8. SD card slot
9. Ethernet connector

## 2.2 Specification

Category	Feature	Specification	
Chipset	LoRa®	Semtech SX1301/SX1257	
	Bluetooth®	Cambridge Silicon Radio CSR8811 A08	
	Wi-Fi	Qualcomm Atheros QCA6004	
Wireless Characteristics	Wi-Fi Spatial Streams	2x2 MIMO	
	Wi-Fi Frequencies	2.4 and 5 GHz operation	
	Conducted Maximum Transmit Power	<b>802.11a (UNII-1, UNII-2A, UNII-2C) or CH 36 – CH140</b>	6 Mbps   17 dBm 54 Mbps   14 dBm
		<b>802.11a (UNII-3) or CH 148 – CH 165</b>	6 Mbps   15 dBm 54 Mbps   14 dBm
		<b>802.11b</b>	1 Mbps   17 dBm 11 Mbps   17 dBm
		<b>802.11g</b>	6 Mbps   17 dBm 54 Mbps   14 dBm
	<b>802.11n (2.4 GHz)</b>	6.5 Mbps (MCS0)   17 dBm 65 Mbps (MCS7)   13 dBm	

Category	Feature	Specification
		<b>802.11n (5 GHz) (UNII-1, UNII-2A, UNII-2C) or CH 36 – CH140</b> 6.5 Mbps (MCS0, HT20)   17 dBm 65 Mbps (MCS7, HT20)   13 dBm (MCS0, HT40)   14 dBm (MCS7, HT40)   11 dBm  <b>802.11n (5 GHz) (UNII-3) or CH 148 – CH 165</b> 6.5 Mbps (MCS0, HT20)   15 dBm 65 Mbps (MCS7, HT20)   12 dBm (MCS0, HT40)   14 dBm (MCS7, HT40)   11 dBm  <b>Bluetooth</b> 1 Mbps   6 dBm 2 Mbps   6 dBm 3 Mbps   3 dBm  <b>Bluetooth Low Energy</b> 1 Mbps   6 dBm
	<b>Wi-Fi Radio</b> <b>Conducted Typical Receiver Sensitivity</b>  <i>Note: All values nominal, ±3 dBm. Variant by channels.</i>	<b>802.11a</b> 6 Mbps   -92 dBm 54 Mbps   -74 dBm (PER ≤ 10%)  <b>802.11b</b> 1 Mbps   -94 dBm 11 Mbps   -87 dBm (PER ≤ 8%)  <b>802.11g</b> 6 Mbps   -91 dBm 54 Mbps   -74 dBm (PER ≤ 10%)  <b>802.11n (2.4 GHz)</b> 6.5 Mbps (MCS0)   -91 dBm 65 Mbps (MCS7)   -71 dBm  <b>802.11n (5 GHz HT20)</b> 6.5 Mbps (MCS0)   -92 dBm 65 Mbps (MCS7)   -71 dBm  <b>Bluetooth</b> 1 Mbps   -83 dBm (1DH1) 2 Mbps   -75 dBm (3DH5) 3 Mbps   -86 dBm  <b>Bluetooth Low Energy</b> 1 Mbps   -86 dBm
LoRa - Wireless Characteristics	<b>LoRa Frequencies</b>  <b>LoRa Radio Conducted TX Power (RG191)</b>  <b>LoRa Radio Conducted RX Sensitivity (RG191)</b>	863 – 870 MHz (EU) – RG186 902 – 928 MHz (US) – RG191  28 dBm (max entry in Radio TX Power Table) 0 dBm (min entry in Radio TX Power Table)  -127 dBm (Bandwidth = 125 kHz, Spreading Factor = 7)

Category	Feature	Specification
	<b>LoRa Radio Conducted TX power (RG186)</b>	Supports TX power as per ETSI Frequency bands 25 dBm (max entry in Radio TX Power Table) -3 dBm (min entry in Radio TX Power Table)
	<b>LoRa Radio Conducted RX Sensitivity (RG186)</b>	-125 dBm (Bandwidth = 125 kHz, Spreading Factor = 7) -123 dBm (Bandwidth = 250 kHz, Spreading Factor = 7)
<b>Interfaces</b>	<b>Wired</b>	Ethernet - RJ45 Connector
	<b>Wireless</b>	Wireless
<b>Power</b>	<b>Supply Voltage</b>	12V/1A
	<b>Power Adapter</b>	External DC Power Supply (has 12V /2A rating) with regional plug adapter
<b>Security</b>	<b>Wi-Fi</b>	Standards – WEP, WPA, WPA2 Encryption – WEP, TKIP, AES EAP Types – EAP-FAST, EAP-TLS, EAP-TTLS, PEAP-GTC, PEAP-MSCHAP, PEAP-MSCHAPv2, PEAP-TLS, LEAP
<b>Software</b>	<b>Operating System</b>	Embedded Linux, 4.x Kernel
	<b>LoRa</b>	Packet Forwarder (default) Support for The Things Network, Stream Communications, Lorient
	<b>Configuration</b>	Web-based interface via Ethernet/Wi-Fi
<b>Physical</b>	<b>Dimensions</b>	133 x 275 x 30 mm (enclosure only)
<b>Environmental</b>	<b>Operating Temperature</b>	-30° to +70°C <i>Note: The RG1xx gateway operating temperature range is limited to -30° to +70°C due to the supplied external power supply. The RG1xx gateway without the external power supply is certified for -40° to +85°C.</i>
<b>Regulatory</b>	<b>Approvals (RG186)</b>	<b>CE</b> Health and Safety – IEC 60950-1 V2.0 Radio – EN300 220-1 V3.1.1 (2017-02); EN300-220-2 V3.1.1 (2017-02) EMC – EN301 489-1 V2.2.0 (2017-03); EN301 489-3 V2.1.1 (2017-03)
	<b>Approvals (RG191)</b>	<b>FCC</b> – Contains FCC ID: SQG-WB50NBT <b>IC</b> – Contains IC ID: 3147A-WB50NBT <b>FCC</b> – Contains FCC ID: SQG-1001 <b>IC</b> – Contains IC ID: 31347A-1001
<b>Wi-Fi Antenna</b>	<b>Model</b>	Laird MAF94051
	<b>Type</b>	Dipole

Category	Feature	Specification
	<b>Connector</b>	RP-SMA
	<b>Antenna Gain</b>	2.1 dBi (2.4-2.5 GHz), 2.4 dBi (4.9 GHz) 2.6 dBi (5.25 GHz), 3.4 dBi (5.875 GHz)
<b>LoRa Antenna</b>	<b>Model</b>	Laird 001-0028 (863-870 MHz) used with RG186 Laird 001-0002 (902-928 MHz) used with RG191
	<b>Type</b>	Dipole
	<b>Connector</b>	RP-SMA
	<b>Antenna Gain</b>	2.0 dBi (863-870 MHz) used with RG186 2.0 dBi (902-928 MHz) used with RG191
<b>Accessories</b>	<b>Included</b>	1 x 868 MHz antenna (with RG186) or 1 x 915 MHz antenna (with RG191), 2 x 2.4/5 GHz antennas 1 x External DC power adapter
<b>Enclosure</b>	<b>Standard</b>	Molded plastic housing
<b>Warranty</b>		One-year warranty



### 3 CONNECTING THE HARDWARE

#### 3.1 Connect the Gateway

To use the gateway, you must power up the gateway and access the web interface via the Ethernet port. To do this, follow these steps:

1. Follow the label on the box and connect the three antennas. Refer to [Antenna Configuration](#) for additional information.
2. Connect the power supply (see #2 in [Figure 3](#)).
3. Connect the gateway to your router (#3 in [Figure 3](#)) using the Ethernet cable (#1 in [Figure 3](#)). Alternatively use the Wi-Fi Quick Config mechanism. Refer to [Wi-Fi Quick Config](#) for additional information.

Your gateway is now connected and ready.

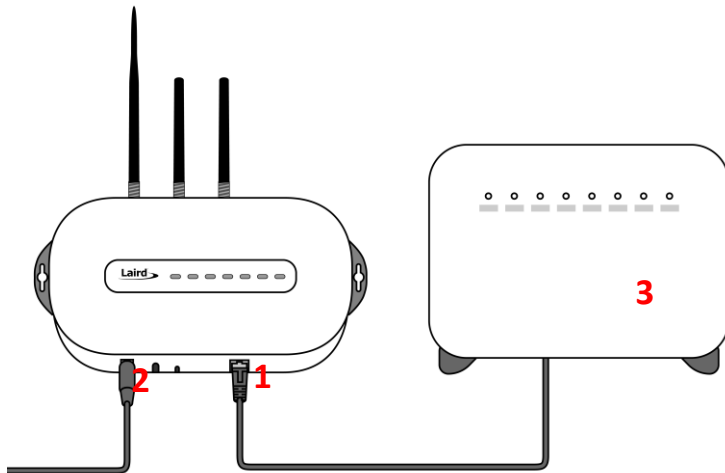
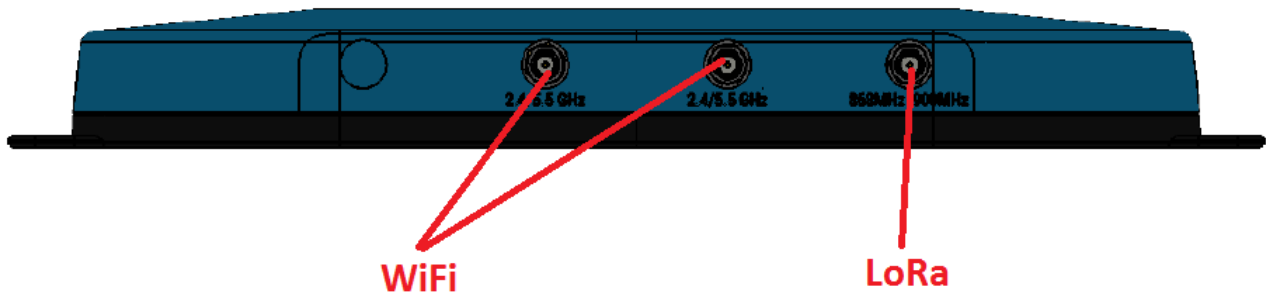

Figure 3: Connecting the gateway

##### 3.1.1 Antenna Configuration

To configure the antenna properly, do the following:

1. Attach the two shorter antennas to the 2.4/5.5 GHz (Wi-Fi) ports.
2. Attach the third and longer antenna to the 868 MHz/900 MHz (LoRa) port.



### 3.1.2 Wi-Fi Quick Configuration

The gateway includes a mode to allow you to configure without ethernet access, in the case that you wish to join a wireless network.

Apply power to the gateway and allow to start, then perform the following:

1. Depress and hold the user button (see #2 in [Figure 2](#)) for seven seconds.
2. From a wirelessly enabled device perform a scan.
3. Connect to the access point rg1xx**29378B**, where “29378B” are the last six digits of the Ethernet MAC address found on the label on the bottom of the gateway ([Figure 4](#)).  
The network is secured with WPA2 with a password that is the same as the SSID. We recommend that you change the default password for security reasons. The password can be changed on the Wi-Fi > Advanced web page.

Upon logout or client disassociation, Wi-Fi Quick Config shuts down and normal operation resumes.

## 4 LOG INTO THE GATEWAY

To log into the gateway web interface, follow these steps:

1. Determine the last three bytes of your gateway’s Ethernet MAC address. This can be found on the label on the bottom of the gateway; the last three bytes are highlighted ([Figure 4](#)).

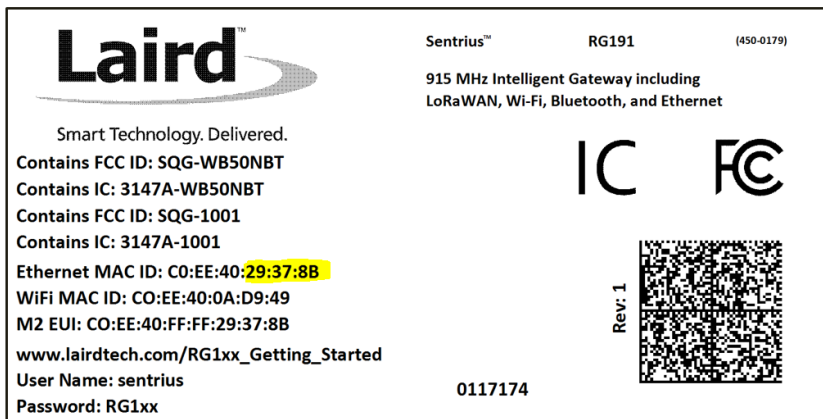

*Figure 4: Bottom label – last three bytes of the Ethernet MAC address highlighted*

2. Enter the URL into the web browser to access the web interface. For example, for the gateway used in this guide, the URL is <https://rg1xx29378B.local>, where “29378B” are the last six digits of the Ethernet MAC address. In Wi-Fi quick config mode, the gateway can also be accessed via the IP address at <https://192.168.1.1>
3. Accept the self-signed security certificate in the browser.
4. Click **Advanced** ([Figure 5](#)).

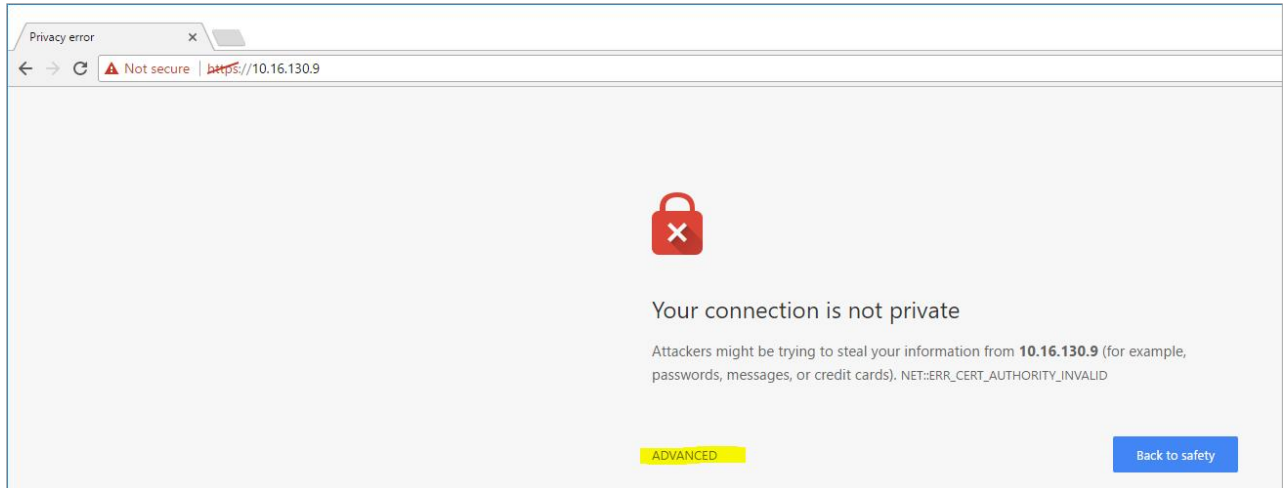

Figure 5: Web interface – first screen

1. Click **Proceed** (Figure 6).

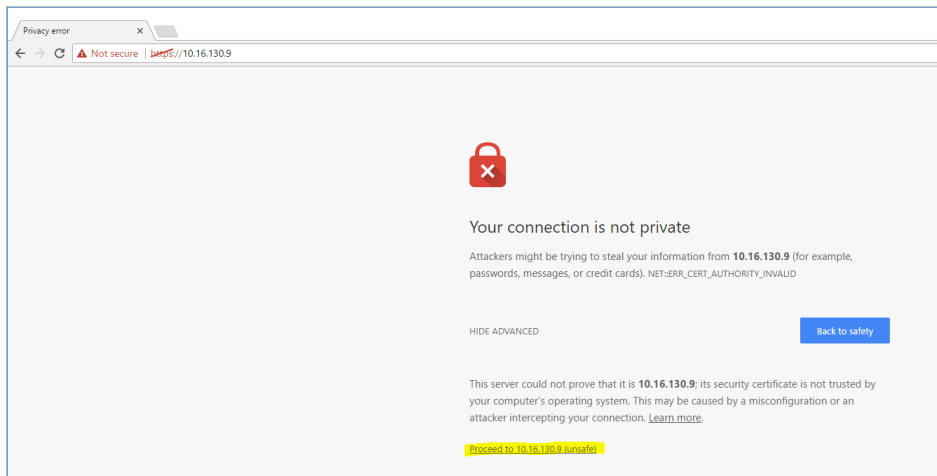

Figure 6: Web interface – second screen

2. Log on using the following default credentials:

Username: sentrius  
Password: RG1xx

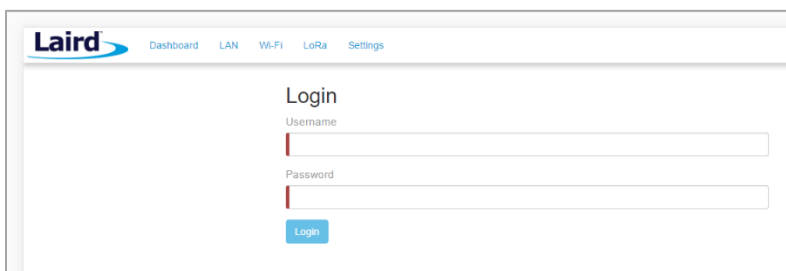
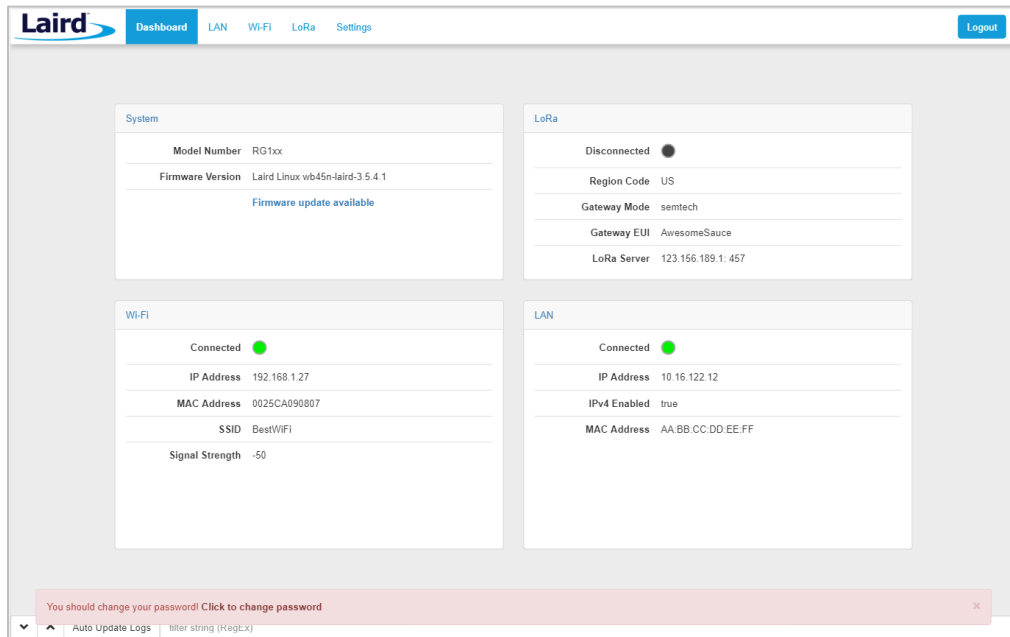

Figure 7: Gateway interface login screen

After logging in, the program warns you to change the default credentials for security reasons (Figure 8).



**Figure 8: Change the default credentials**

Only one login session is allowed at a time. If there is another active session active, the program warns you before allowing you to take over the session (Figure 9).

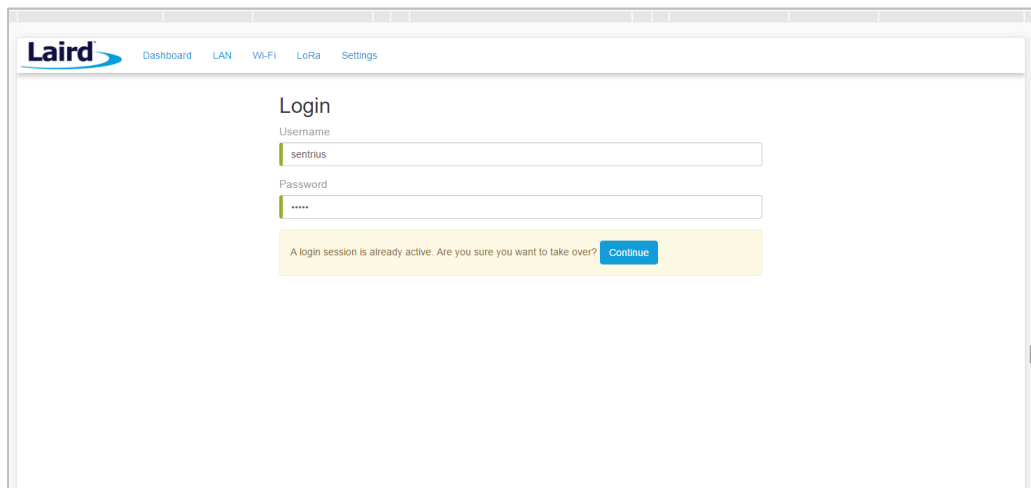

**Figure 9: Active session warning**

3. Click **Continue** to log in.

## 5 LAN CONNECTION SETUP

The LAN menu allows selections for configuration and status of the IPv4/IPv6 wired network. The current status of the IPv4 network is also displayed. To access this section, click **LAN** in the page menu.

### 5.1 IPv4 Configuration

The first page for configuring the Ethernet LAN connection is the IPv4 Configuration page. There are two basic modes of operation – DHCP and Static. These are selected in the IP Address Acquisition Method drop-down box (Figure 10). The gateway factory default setting is DHCP.

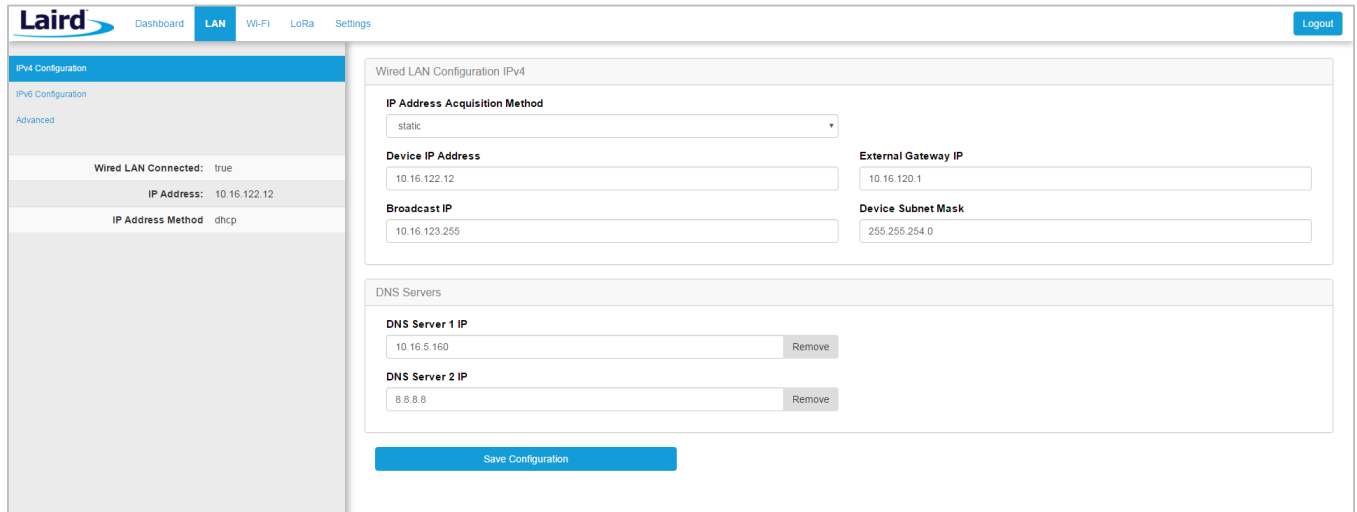

Figure 10: IPv4 Configuration page

- **DHCP** – When in DHCP mode, all settings are provided by the DHCP server. All configuration settings (except IP Address Acquisition Method) are greyed out. IP values provided by DHCP are displayed but cannot be changed.
- **Static** – When the IP Address Acquisition Method is set to static, all IP settings are fixed and saved in the device. The external Gateway IP address is optional and may be left blank. DNS Server IP addresses are also optional. Zero, one, or two DNS servers may be specified.

### 5.2 IPv6 Configuration

Select the IPv6 configuration by clicking the IPv6 menu item in the side menu of the LAN view (Figure 10). The IPv6 configuration settings are shown below.

There are two fully-supported modes for IPv6 addressing:

- **DHCP** – In DHCP mode, all settings are provided through communication with an IPv6 server on the network.
- **Auto** – In auto mode, you have the option of selecting the auto DHCP method (either stateless or SLAAC). As of June 2017, IPv6 static mode is only partially supported. Please see the software release notes for current information.

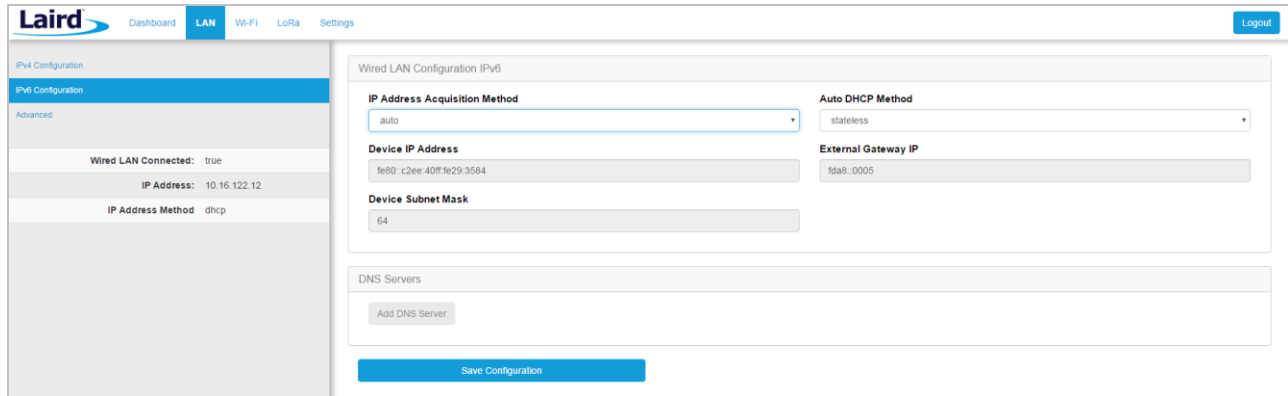

Figure 11: IPv6 Configuration page

### 5.3 Advanced View

Select the advanced view by clicking the Advanced menu item in the LAN sidebar (Figure 12). The Advanced view shows all network information provided by the Wi-Fi module in the gateway. Depending on the settings of the network and the gateway, not all settings may apply to the current mode of operation. This view is intended to support advanced users in troubleshooting their network.

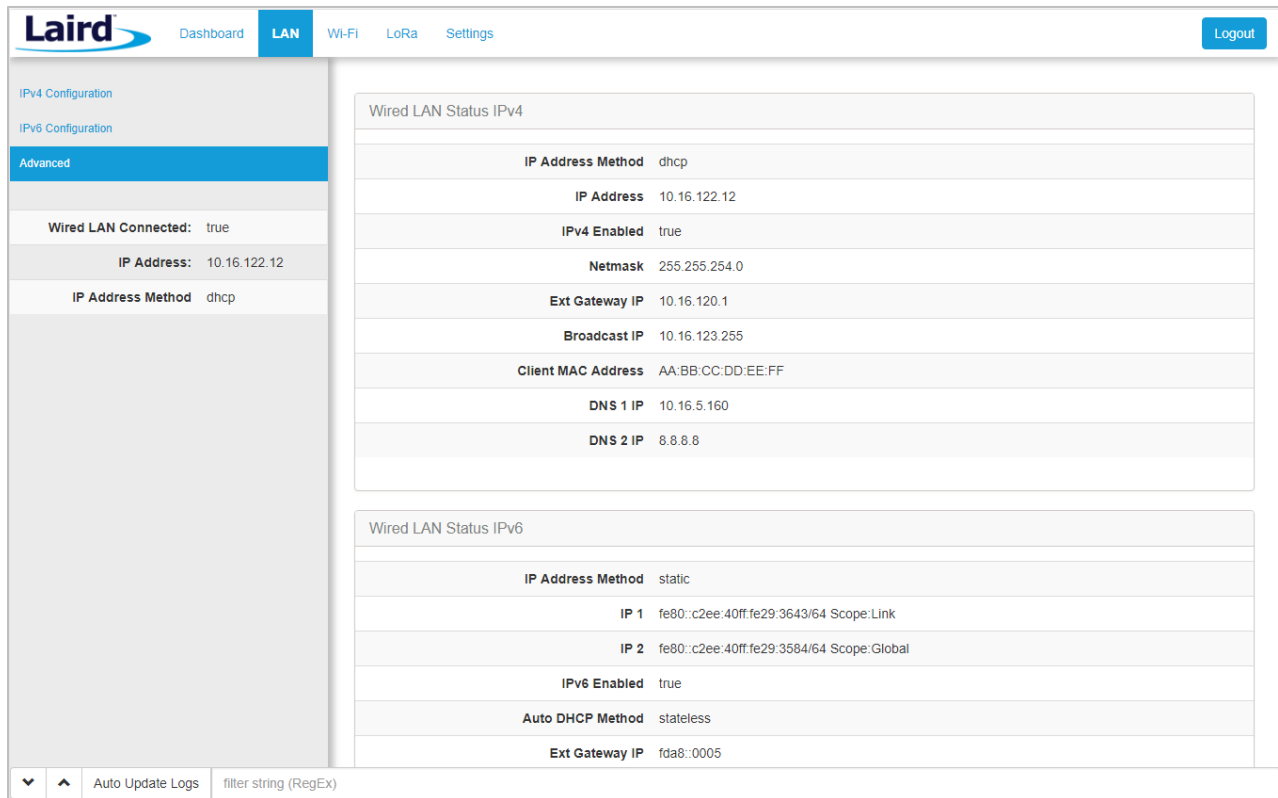

Figure 12: Advanced view

## 6 Wi-Fi CONNECTION SETUP

By default, the gateway's Wi-Fi radio is not configured to connect to a Wi-Fi network. The user must access the web interface on the gateway via the Ethernet interface to setup the Wi-Fi connection.

To setup a Wi-Fi connection, click the **Wi-Fi** tab in the main menu (Figure 13).

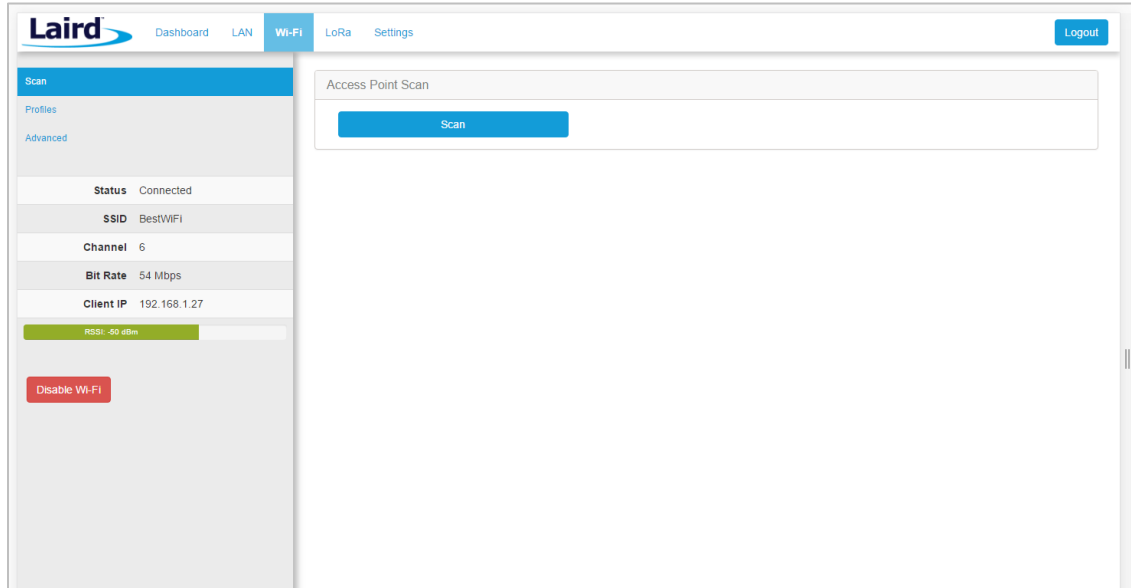

Figure 13: Wi-Fi connection setup

In the sidebar on the left, you can navigate to various Wi-Fi pages and see the status of the Wi-Fi interface. There is also a button to enable/disable the Wi-Fi radio.

### 6.1 Use Scan to Add a Profile

To use the scan function to add a profile, follow these steps:

1. **Connect to a Wi-Fi network** – click **Scan** to scan for nearby Wi-Fi networks. Scanning continues until you click **Stop** or click on one of the listed scan results (Figure 14).

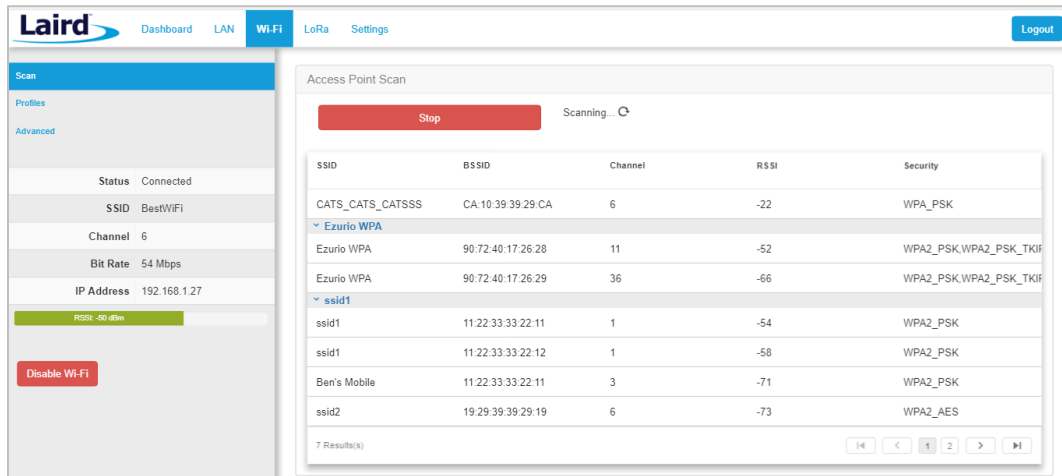

Figure 14: Scan function

2. Click on the applicable scan result.
3. In the Wi-Fi profile window, enter the appropriate credential information for your chosen Wi-Fi network (Figure 15).

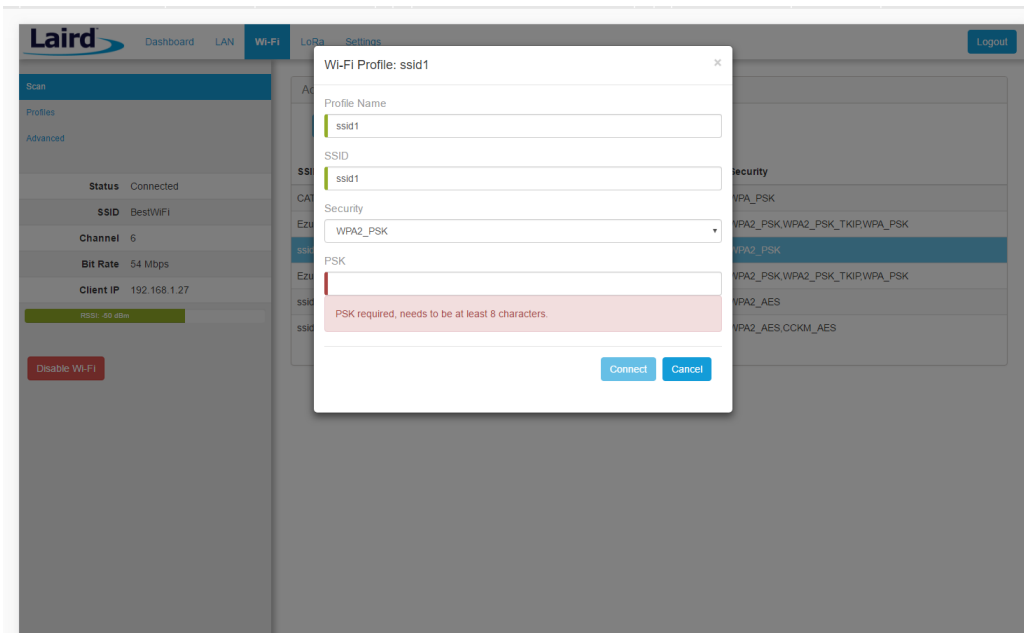

Figure 15: Wi-Fi profile window

## 6.2 Manually Adding a Profile

To add a Wi-Fi network profile manually, follow these steps:

1. Click the **LAN** button in the main menu, then click the **Profiles** button in the left menu. This page is useful for adding a hidden Wi-Fi network that is not broadcasting its SSID (Figure 16).

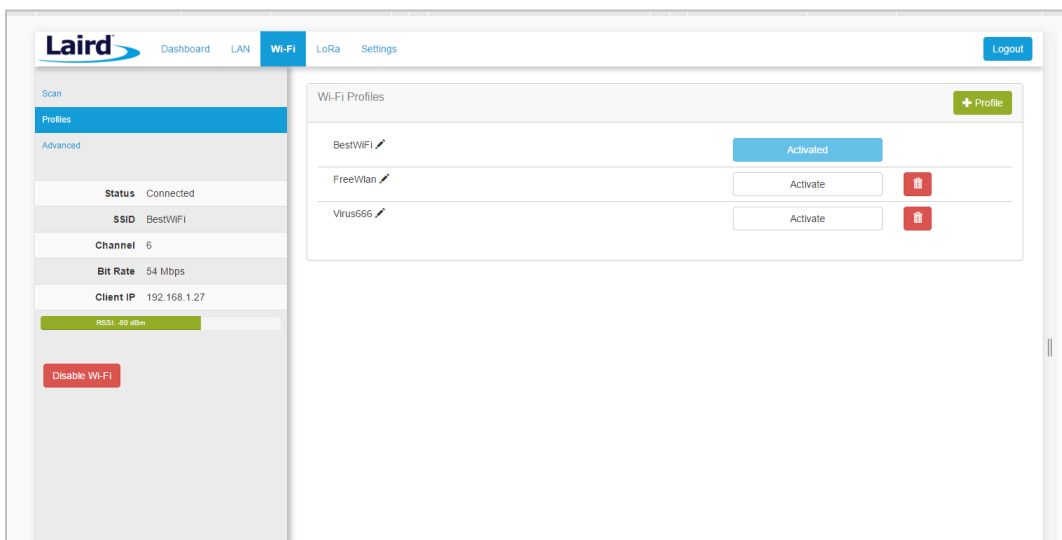

Figure 16: Wi-Fi profiles page

The profile page shows all Wi-Fi profiles that are saved in the gateway. You can add, activate, or delete the profiles shown on this page.



2. Click **+ Profile** to display the Wi-Fi profile dialog (Figure 17).

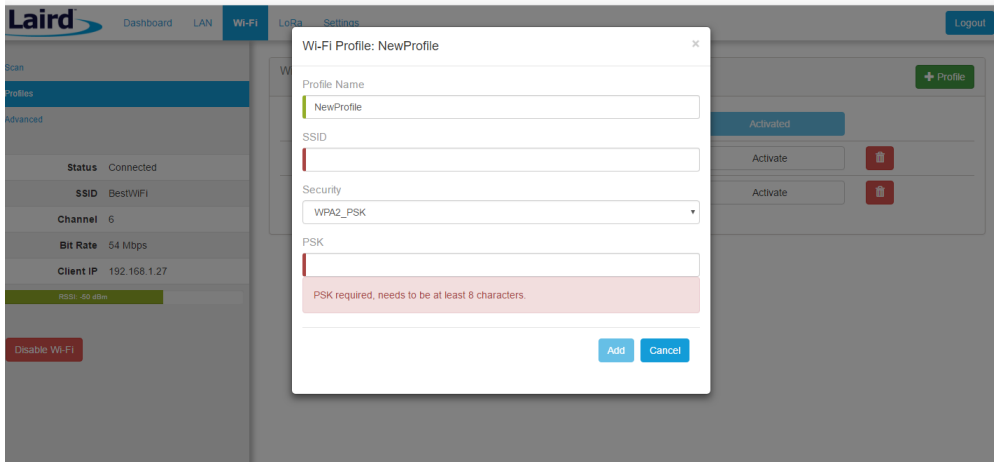

Figure 17: Wi-Fi profile dialog

3. Enter the appropriate information for the new profile.
4. Click **Add**.

### 6.3 Wi-Fi Advanced Page

The Wi-Fi advanced page shows more detailed information about the Wi-Fi radio status and allows the user to configure the Quick Config AP mode password (Figure 18).

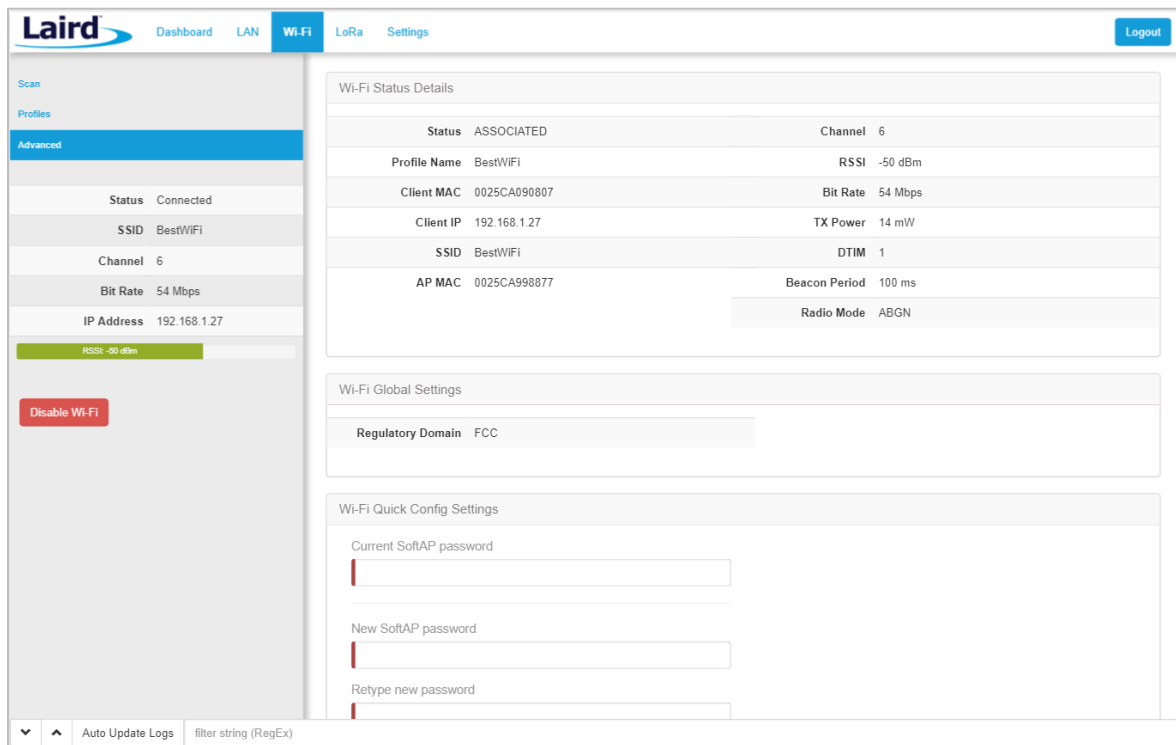

Figure 18: Wi-Fi Advanced page

## 7 LORA CONNECTION SETUP

The side panel for the LoRa Gateway allows selections for configuration and status of the LoRa network card. The status of the LoRa Network is also displayed (Figure 19).

**Note:** The LoRa Region Code is displayed here. Be sure that the gateway you are operating matches the region in which you are operating it.

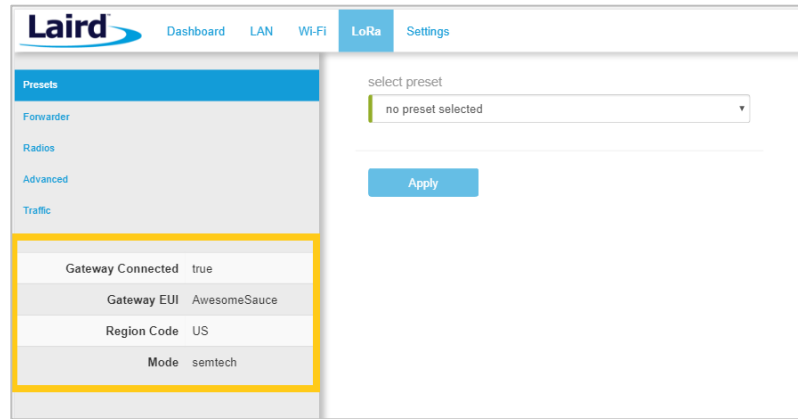

Figure 19: LoRa connection setup page

The Gateway ID (also known as the gateway EUI), is used to uniquely identify the RG1xx gateway. It is required when registering the gateway on a LoRa network server. The gateway EUI is also printed on the bottom label of the gateway, with the label M2 EUI.

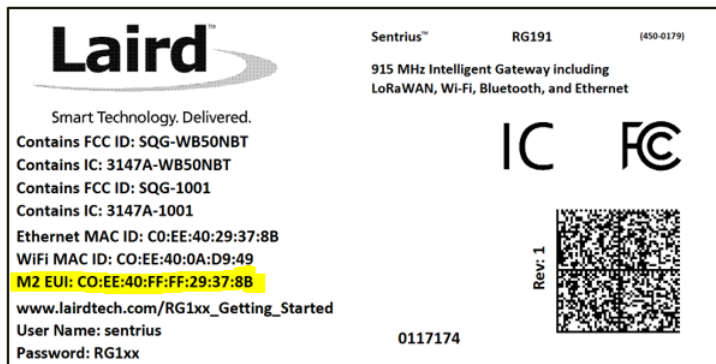

Figure 20: Gateway label

### 7.1 Using Presets

The Sentrius RG1xx contains multiple preset configurations for connecting to a third-party server or as the basis for a private network. These presets configure the forwarder and the channel plan.

To apply a preset configuration, follow these steps:

1. Click the **LoRa** tab in the main menu. The default page of the LoRa menu is the **Presets** page (also accessible in the left side menu of the LoRa pages).
2. Select the preset from the drop down. Information about this preset is displayed in a panel to the right (Figure 21).
3. Click **Apply** to apply the preset configuration. After a few moments, a green confirmation appears on the bottom of the page.

**Note:** After applying a preset, further changes can be made on the other screens. Some presets (such as Loriot) use a custom forwarder and may not be modified.

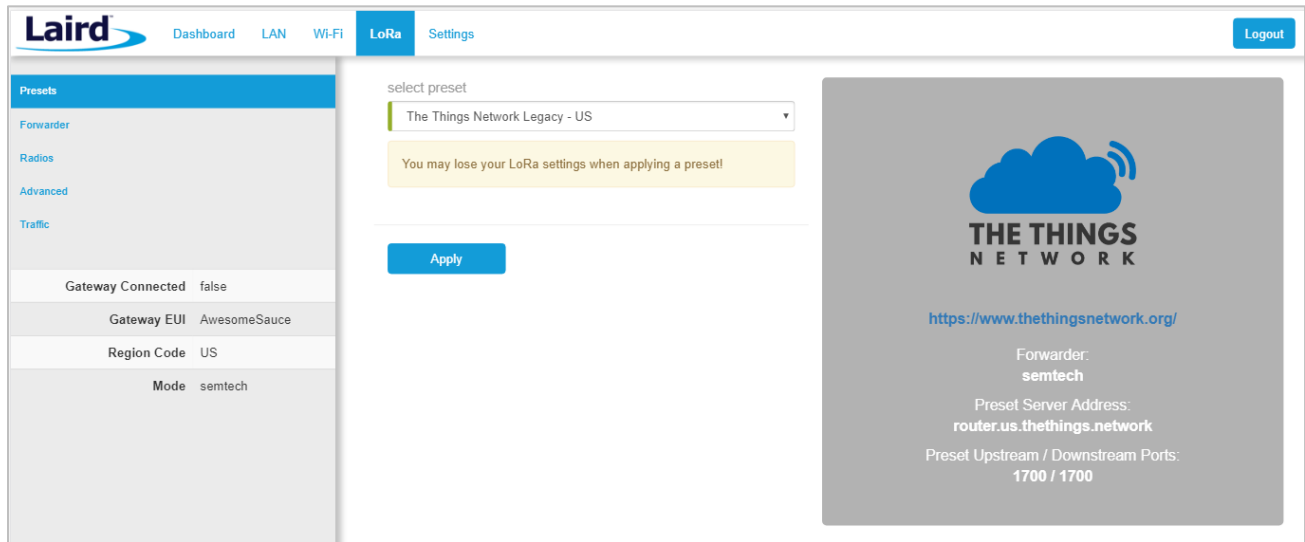

Figure 21: Selecting a preset configuration

## 7.2 Forwarder

Click **Forwarder** in the left-hand menu of the LoRa pages to access the Forwarder settings.

### 7.2.1 Mode

The forwarder page allows configuration of the packet forwarder. The mode allows the user to change to different packet forwarders.

### 7.2.2 Configuration

The configuration changes based on what packet forwarder is used.

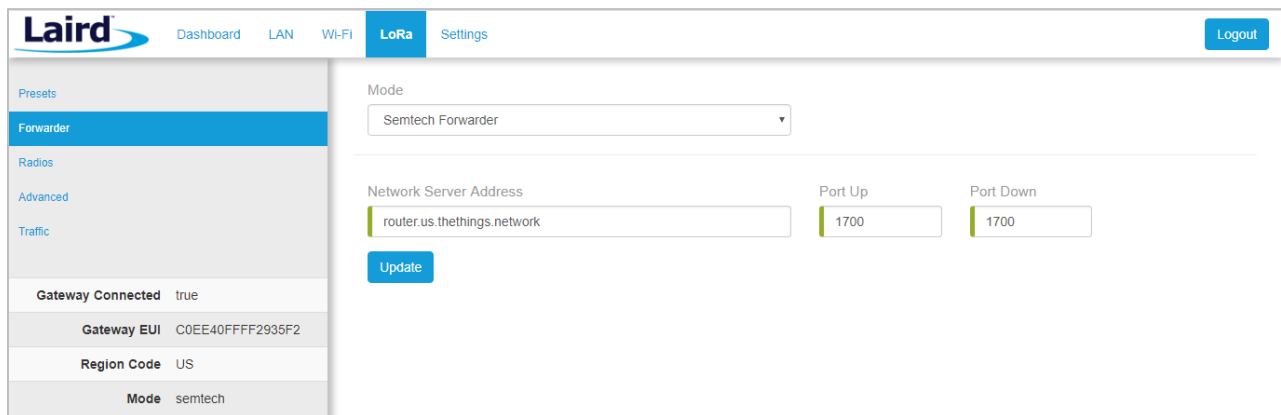

Figure 22: Semtech packet forwarder configuration

### 7.3 Radios

The radio page provides configuration of the radios and channels. The LoRa card has two radios (Radio 0 and Radio 1). This interface allows advanced users to change radio and channel assignments within the allowed range per the gateway region. Depending on the forwarder being used, the radio configuration may not be available.

#### 7.3.1 Channel Plan Graphic

At the top of the Radios page is a graphic representation of the full bandwidth range, channels, and radios. This graphic is different for gateways operating in US mode and EU mode.

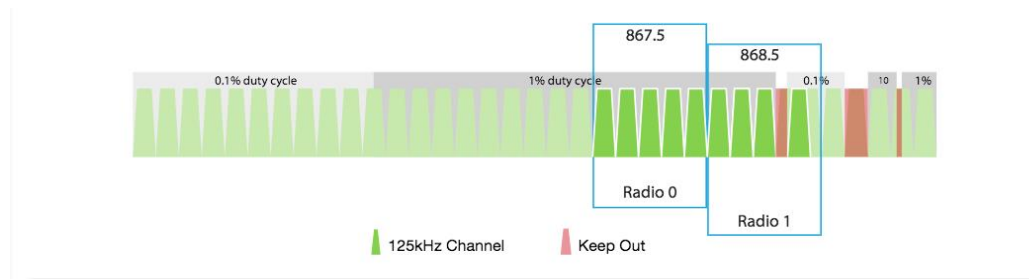

#### 7.3.2 Radio Center Frequencies

Each radio is assigned a center frequency. Channels are then assigned to each radio and given an offset from the center (Figure 23).

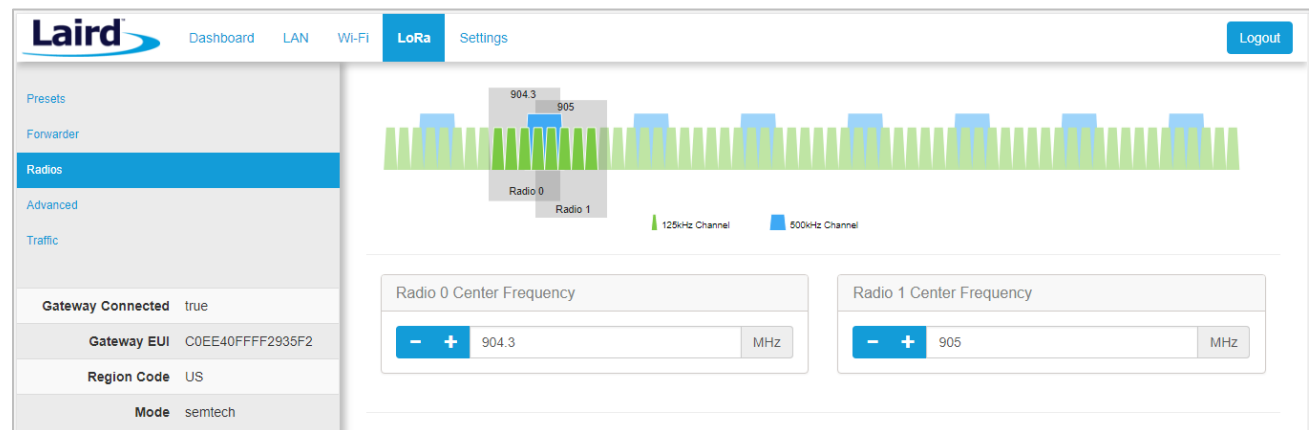

Figure 23: Channel assignments

#### 7.3.3 Channels

Channels are enabled and assigned to either radio. Each radio can have up to five channels assigned to it.

The channel’s frequency is an offset of its radio’s center frequency. For most channels with a 125-kHz bandwidth, the offset can be -0.4 to +0.4 MHz.

Lora STD and FSK channels have configurable bandwidth. For these channels, when operating in 250-kHz or 500-kHz bandwidth, the offset can be -0.3 to +0.3 MHz.

Each channel should be placed at least 200 kHz from any other channel, otherwise the channel’s bandwidth overlaps. While this configuration still functions, there is wasted bandwidth. The interface displays a warning and marks each channel in red if they overlap (Figure 25). Channel configuration is shown in Figure 24.

Enable Channel	Radio	Channels	Frequency
<input checked="" type="checkbox"/> Multi SF 0	Radio 0	- +	911.9 MHz
<input checked="" type="checkbox"/> Multi SF 1	Radio 0	- +	912.1 MHz
<input checked="" type="checkbox"/> Multi SF 2	Radio 0	- +	912.3 MHz
<input checked="" type="checkbox"/> Multi SF 3	Radio 0	- +	912.5 MHz
<input checked="" type="checkbox"/> Multi SF 4	Radio 1	- +	912.6 MHz

Figure 24: Channels window

Enable Channel	Radio	Channels	Frequency
<input checked="" type="checkbox"/> Multi SF 0	Radio 0	- +	903.9 MHz
<input checked="" type="checkbox"/> Multi SF 1	Radio 0	- +	904 MHz

Figure 25: Overlapping channels

### 7.3.4 LoRa Radio Card (US)

Gateways that operate in the US region should have a 500-kHz channel. In [Figure 26](#), the allowed placement of these channels displays larger and blue.

If a 500-kHz channel is not configured, the interface displays a warning.

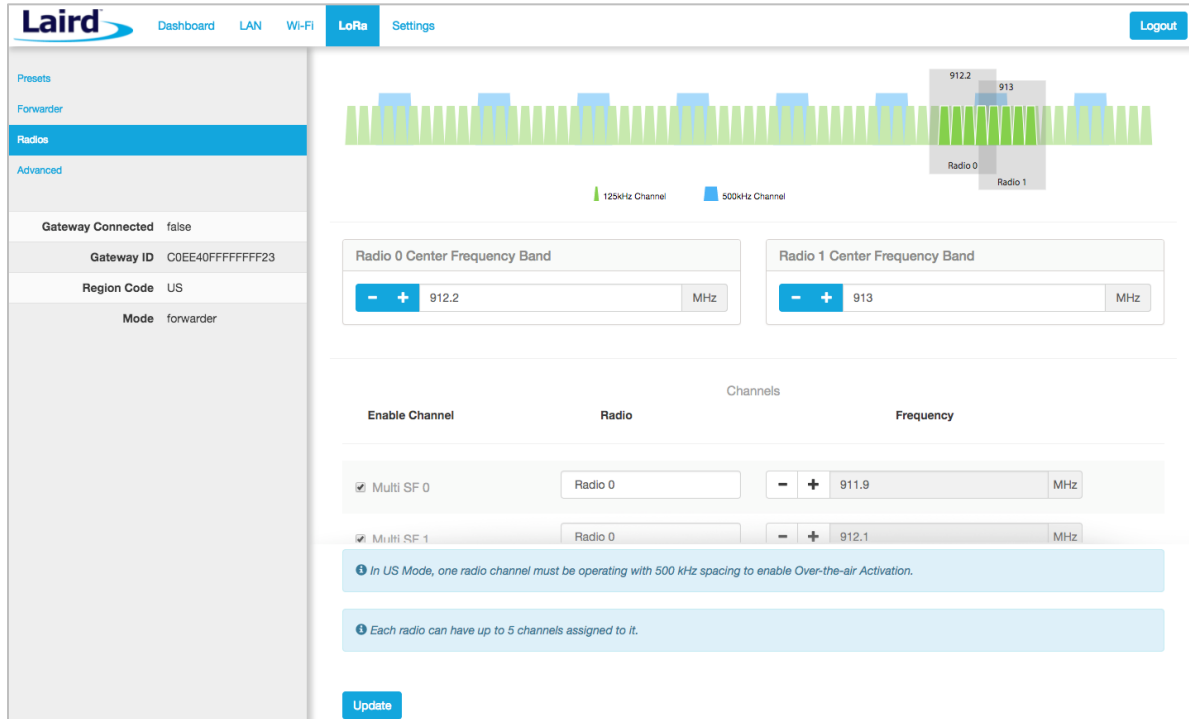

Figure 26: US region gateways

### 7.3.5 LoRa Radio Card (EU)

There are three mandatory channels for gateways that operate in the EU region. These channels are 868.1, 868.3, and 868.5.

The EU region bands have different duty cycles. This is indicated with a grey background box and label in [Figure 27](#). A higher duty cycle allows higher throughput.

The EU region specifies *keep out* areas in the allowed frequencies. These are highlighted in red on the illustration. The interface displays a warning if a channel lies in a keep-out area.

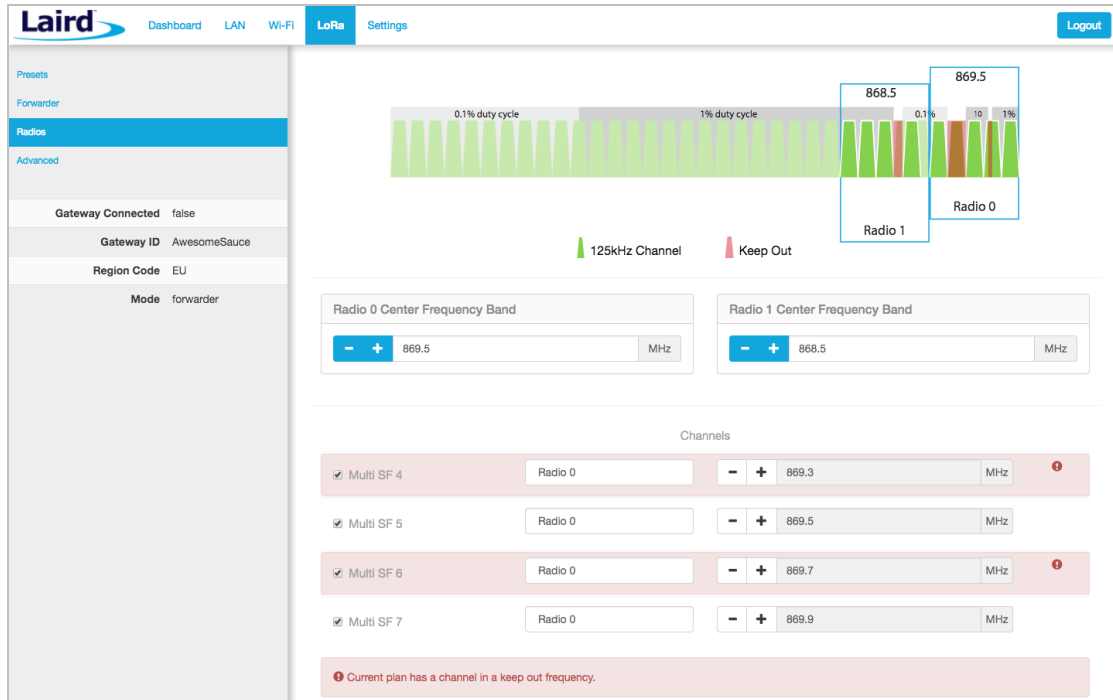

Figure 27: EU region gateways – keep out channels

## 7.4 Advanced Configuration

The Advanced page provides additional configuration options for the specific forwarder.

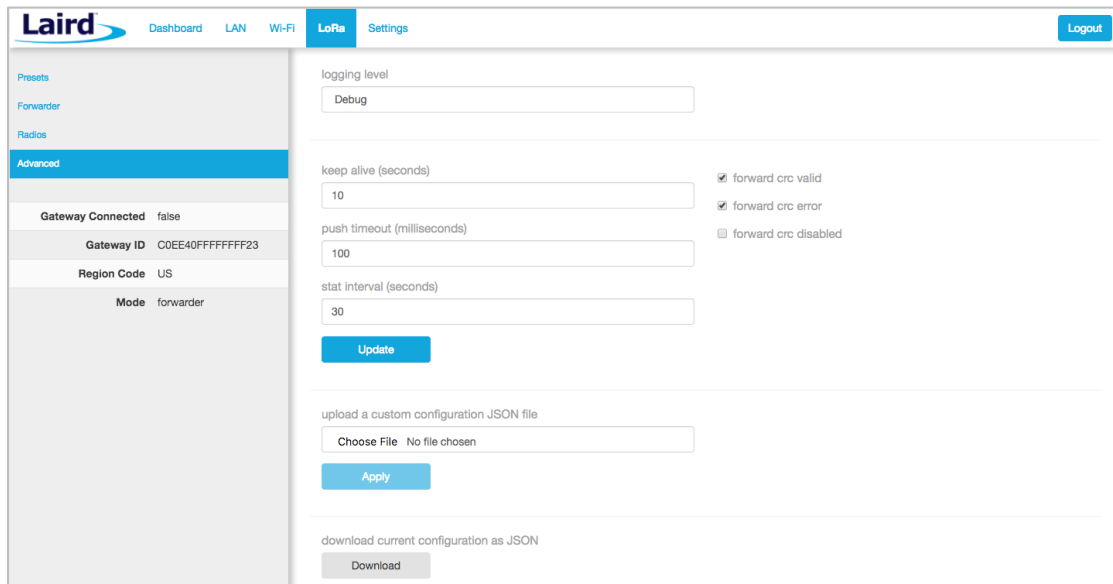

Figure 28: Advanced configuration page

The current configuration may be saved as a JSON text file. This file can also be uploaded to restore the saved configuration. This feature is useful for configuring multiple gateways with the same configuration (Figure 29).

**Note:** If the forwarder settings contain credentials, these are not saved in the configuration file for security reasons. The user must take care to set the appropriate credentials when restoring the saved configuration to a gateway.

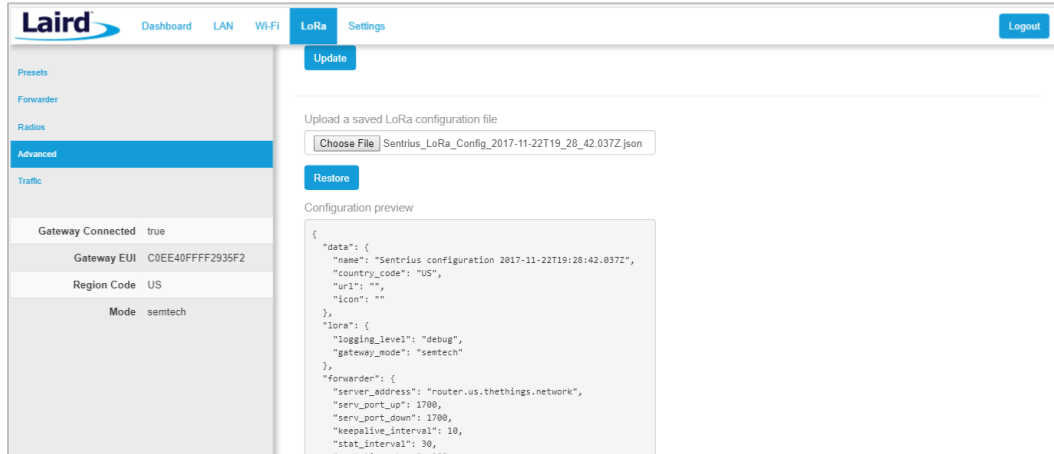

Figure 29: Current configuration file

## 7.5 Traffic

The traffic page is only available when using certain forwarders. When navigating to the traffic page, any recent traffic that has been seen by the gateway displays. To watch live traffic, click **Poll Traffic**. Traffic columns can be sorted, and filters can be applied to one column at a time.

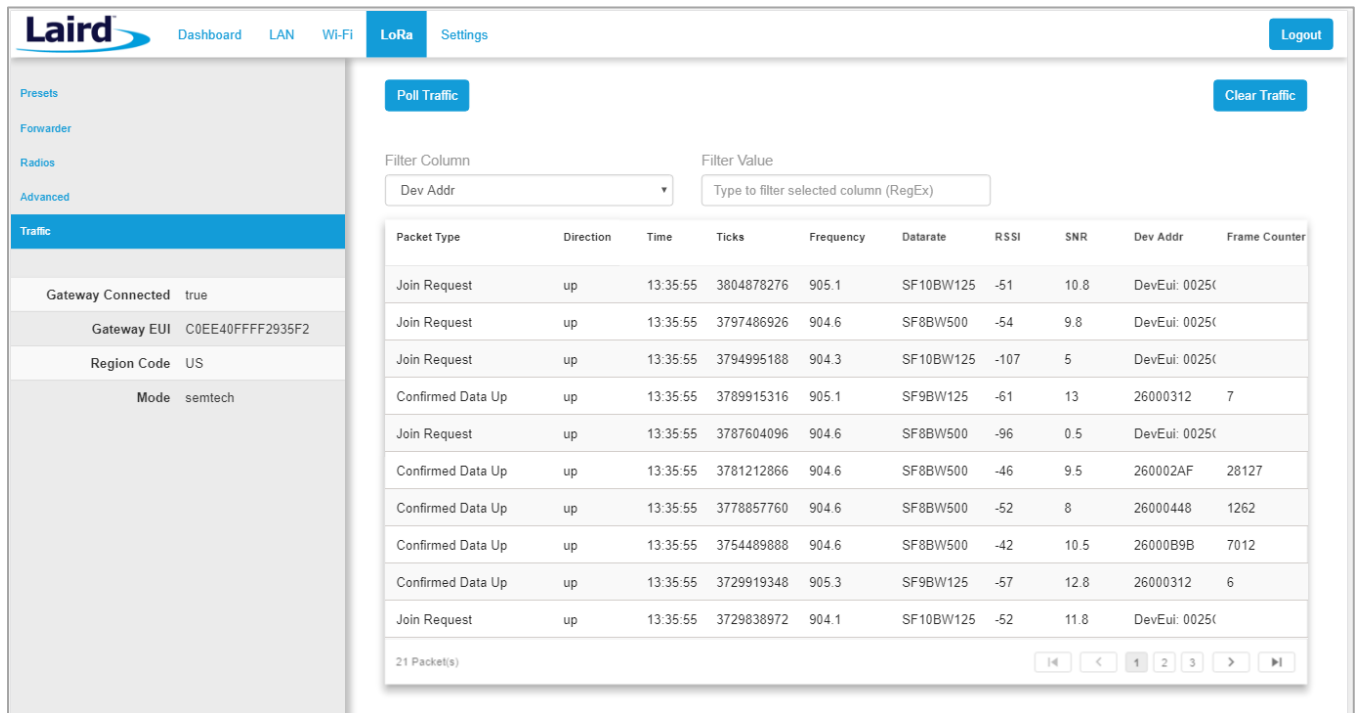

Figure 30: LoRa traffic



Clicking on a traffic row displays packet details.

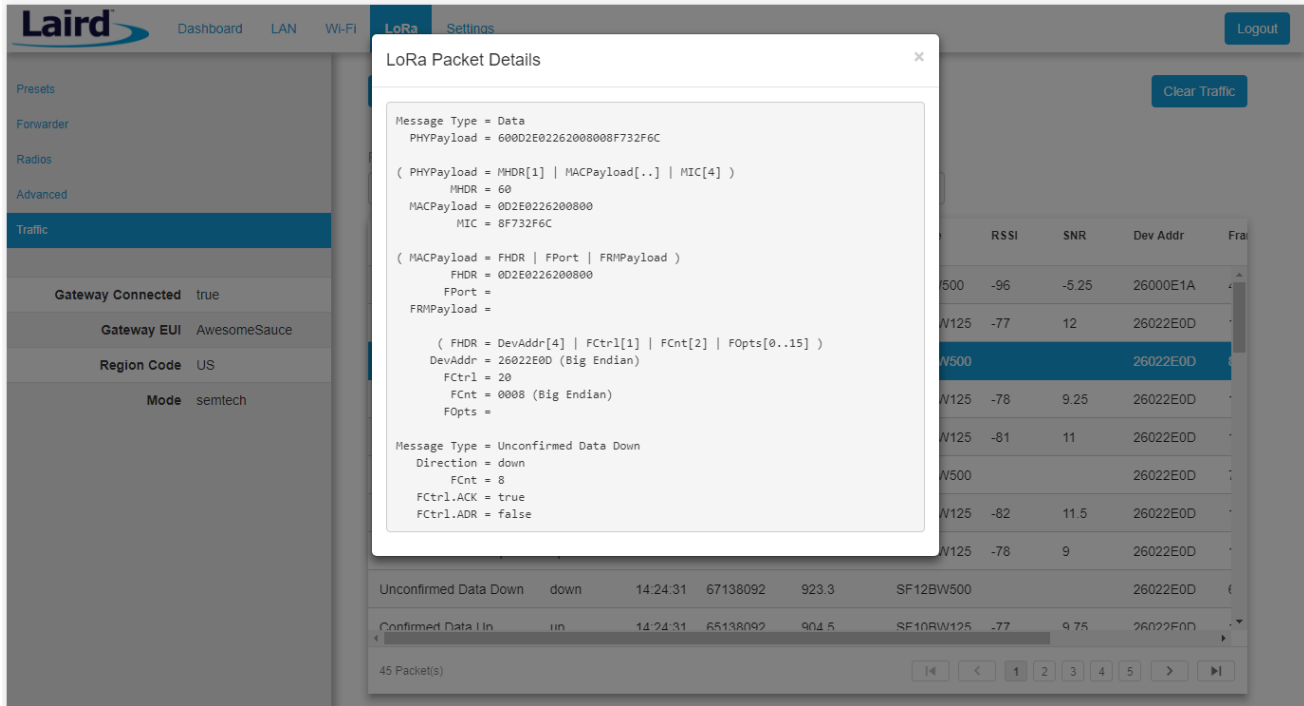

Figure 31: LoRa packet details

## 8 MANAGE THE GATEWAY

### 8.1 Changing Username and Password

To change the login credentials of the gateway, follow these steps:

1. In the main menu, click the **Settings** tab. Then in the left menu, click the **User** tab (Figure 32).
2. Enter the current password, and then the new desired user name and password.
3. Click **Update**.

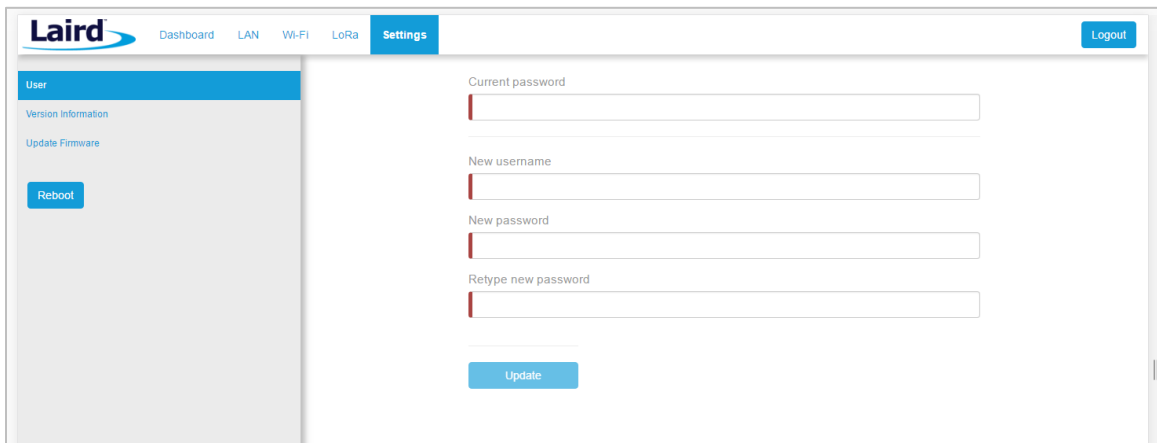

Figure 32: Change user name and password

## 8.2 Version Information

The **Settings > Version Information** page shows detailed software/firmware information of various components in the gateway.

The Build string is the overall firmware version for the gateway software package.

If a firmware update is available, New Build Available row displays.

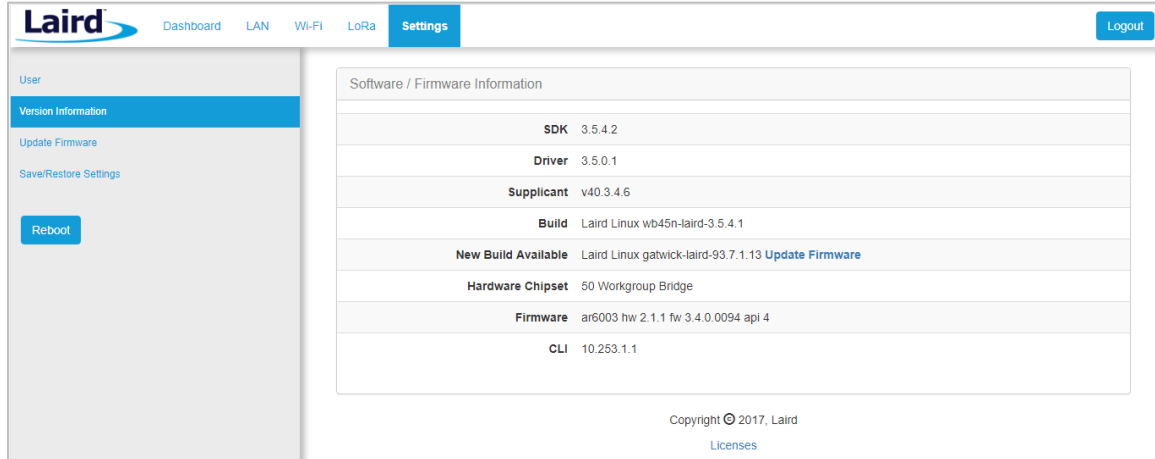

Figure 33: Version information

## 8.3 Updating Gateway Firmware

To update the firmware in the gateway, follow these steps:

1. Click the **Settings** tab in the main menu. Then click **Update Firmware** in the left menu.
2. The default URL where newest official firmware image is hosted is pre-populated in the field. If needed, the user can enter the URL of the location where the firmware image is hosted.
3. Click **Start Update**.

**Note:** Laird hosts the latest firmware for the RG1xx gateway at this link:  
<https://www.lairdtech.com/products/rg1xx-lora-gateway/firmware/latest/fw.txt>

**Warning:** Updating the firmware **MAY** restore the gateway to factory default settings. We advise you to save or make note of any settings the user does not wish to lose.

The firmware update process downloads the firmware to the gateway and then flashes it.

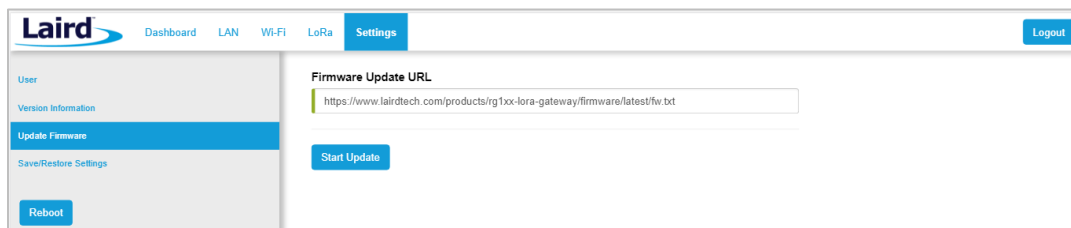
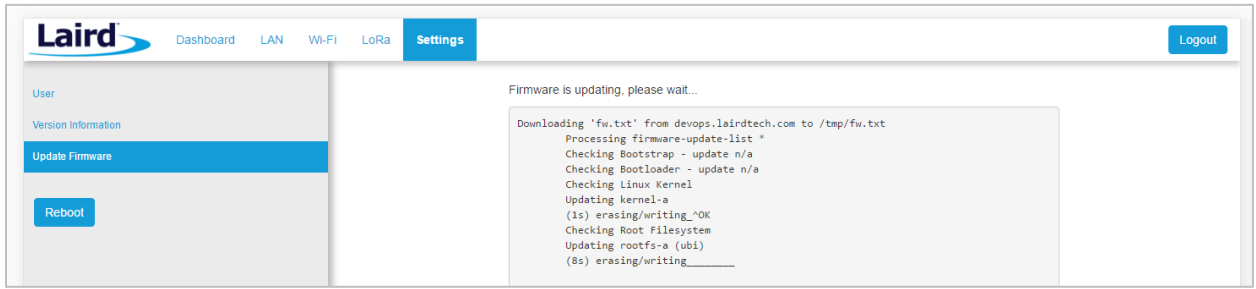

Figure 34: Updating gateway firmware window

During the firmware update, the progress displays as shown in [Figure 35](#).



**Figure 35: Progress indicator**

At the end of the update, you are prompted to reboot the gateway.

4. Click **Reboot**. The gateway must be rebooted for the update to take effect ([Figure 36](#)).

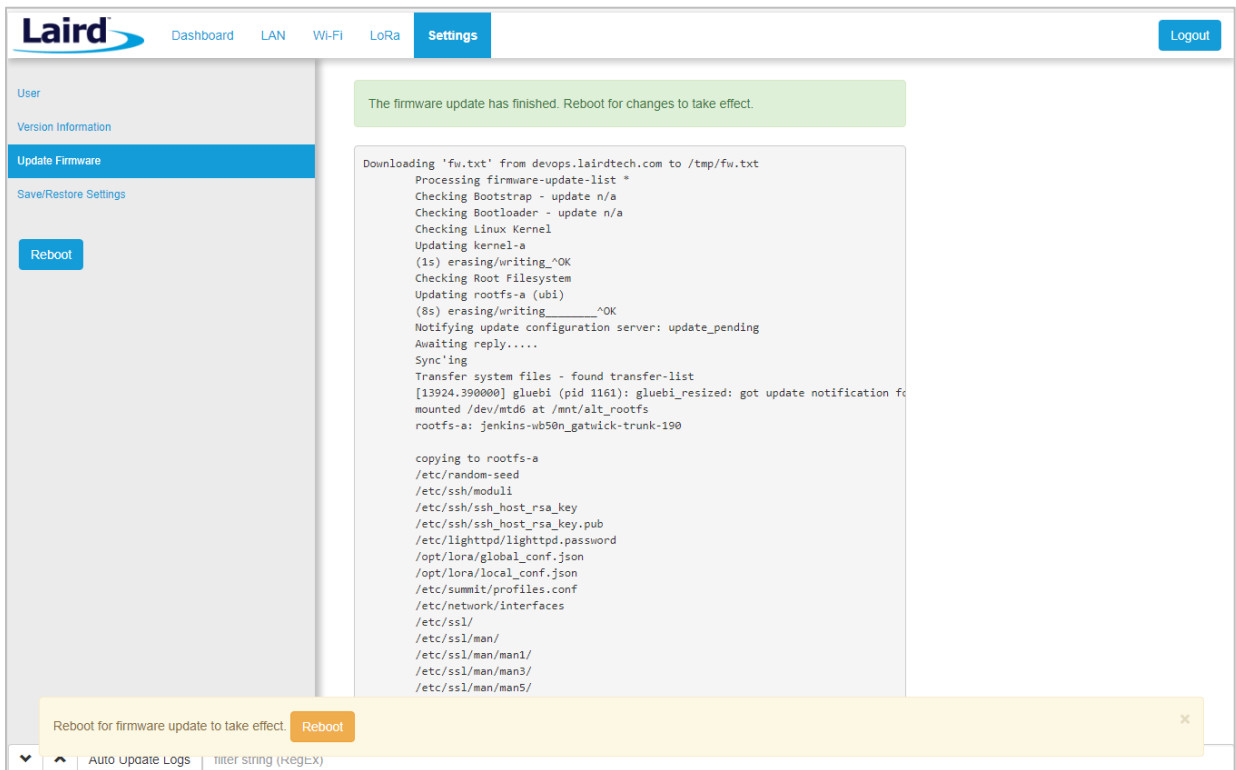

**Figure 36: Reboot prompt**

## 8.4 Save/Restore Settings

All the settings in the gateway can be saved and restored. This is useful for backing up all settings before a factory reset or firmware upgrade. Settings are saved to a JSON file and can be restored on another gateway.

**Note:** Any security related settings like credentials and security certificates are not saved in the JSON file for security reasons. That means security-related settings cannot be restored onto a separate gateway. Security related settings are only saved on the current gateway and are restored on the same gateway.

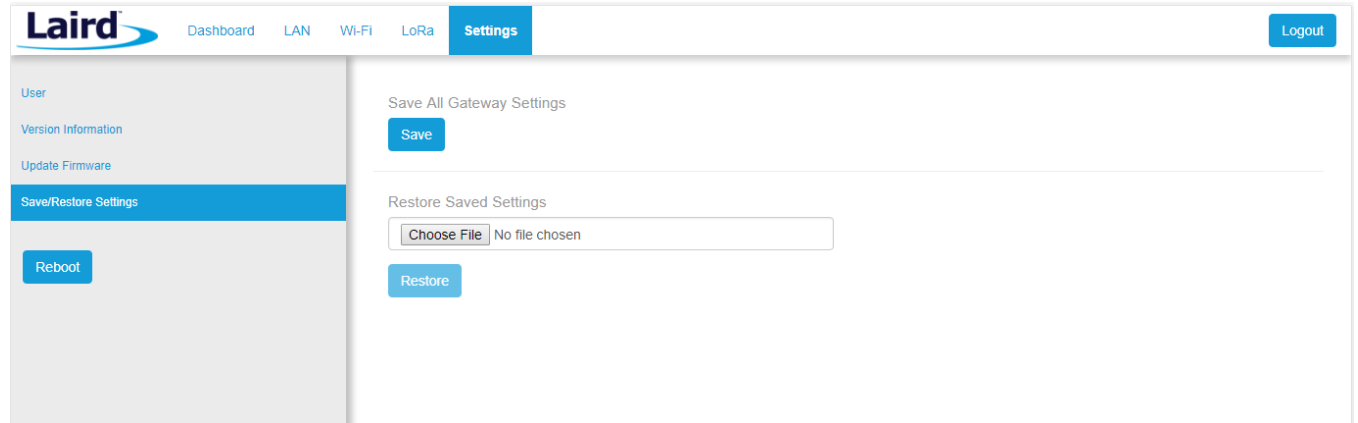

Figure 37: Save/Restore settings

After restoring settings, the gateway must be rebooted for changes to take effect.

## 8.5 Debug

At the bottom of the web UI is a debug pane that can be used to view system logs on the gateway. Click the arrow buttons to expand or collapse the debug pane. To start or stop debug log polling, click **Auto Update Logs**.

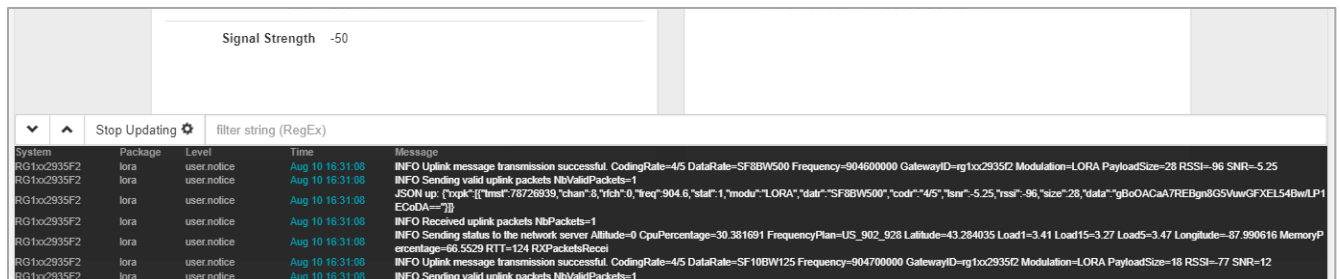

Figure 38: Debug info

## 8.6 Factory Reset

To factory reset the gateway back to default settings, complete the following steps:

1. Hold the user button while power is applied *OR* hold the user button while you press the reset button (Figure 39).



Figure 39: Performing a factory reset

2. Continue to hold the user button until all the LEDs on the top begin to flash.
3. Once the LEDs start flashing, release the user button.
4. The factory defaults are applied, the gateway reboots, and it is ready to use.

## 8.7 Bluetooth

At the time of writing this document the Bluetooth and Bluetooth Low Energy functionality in the gateway is not enabled. Please visit the RG1xx page on Lairdtech.com for more information:  
[www.lairdtech.com/products/rg1xx-lora-gateway](http://www.lairdtech.com/products/rg1xx-lora-gateway).

## 8.8 Additional information:

For the latest version of this manual, quick start guide, regulatory information and firmware updates, please see the Documentation tab the RG1xx page on Lairdtech.com: [www.lairdtech.com/products/rg1xx-lora-gateway](http://www.lairdtech.com/products/rg1xx-lora-gateway).

For technical support, please contact Laird at <https://laird-ews-support.desk.com>.

## 9 IP67 RATED ENCLOSURE

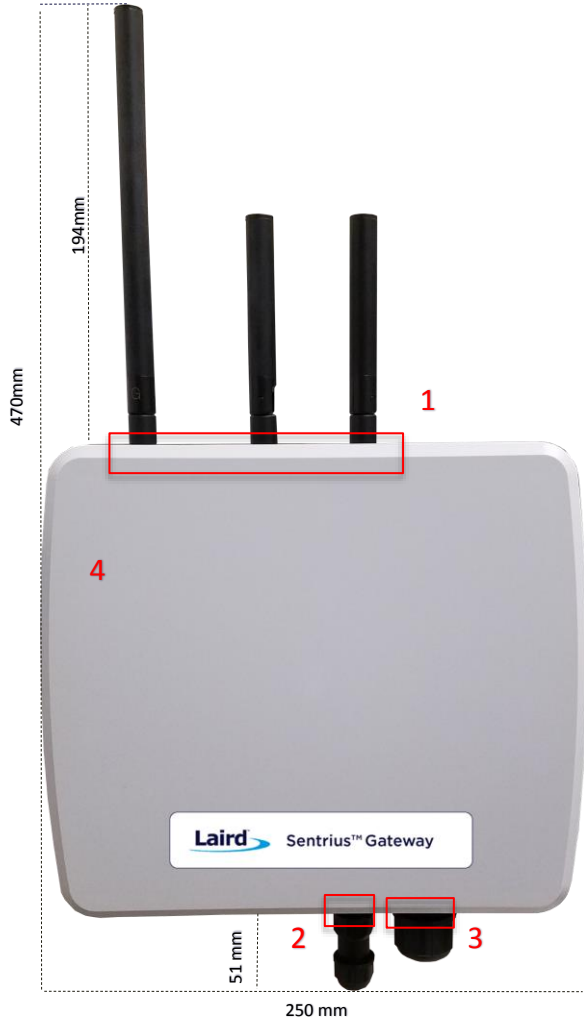

Figure 40: Top of the IP67 Rated Sentrius™ RG1xx Gateway

Reference	Description
1	LoRa and Wi-Fi antennas
2	Power supply module
3	CAT6 Ethernet module
4	Molded plastic cover

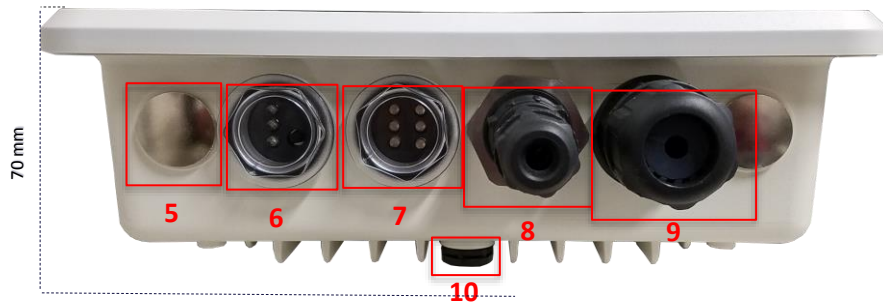

Figure 41: Side panel of the IP67 Rated Sentrius™ RG1xx Gateway

Ref.	Description
5	Metal cover plug (2) – Available data/power ports for expansion
6	Three LED display and User button with transparent dust cover
7	Six LED displays with transparent dust cover
8	Power supply module
9	CAT6 Ethernet module
10	Plastic gore ventilation plug

## 9.1 Specification

Category	Feature	Specification
Interfaces	<b>Wired</b>	CAT6 Ethernet - RJ45 Connector LED Data Communication Ports (2) Optional Data Communication/Power Ports Available for Expansion (2)
	<b>Wireless</b>	<b>Wireless</b>
Power	<b>Supply Voltage</b>	12V/1A
	<b>Power Adapter/Cable</b>	External DC Power Supply (12V/2A rating) with regional plug adapter – Industrial Temperature Rated (supplied by end-user)
	<b>Configuration</b>	Web-based interface via Ethernet/Wi-Fi
Physical	<b>Dimensions</b>	220 x 250 x 70 mm (enclosure only)
Environmental	<b>Operating Temp.</b>	-40° to +85°C
Wi-Fi Antenna	<b>Model</b>	Laird 001-0012 IP67-rated
	<b>Type</b>	Dipole
	<b>Connector</b>	RP-SMA
	<b>Antenna Gain</b>	2.0 dBi (2.4–2.5 GHz), 2.0 dBi (4.9–5.875 GHz)
LoRa Antenna	<b>Model</b>	Laird 001-0029 IP67-rated (863–870 MHz) used with RG186 Laird 001-0011 IP67-rated (902–928 MHz) used with RG191
	<b>Type</b>	Dipole
	<b>Connector</b>	RP-SMA
	<b>Antenna Gain</b>	2.0 dBi (863–870 MHz) used with RG186 2.0 dBi (902–928 MHz) used with RG191
Accessories	<b>Included</b>	<ul style="list-style-type: none"> <li>▪ One 868 MHz antenna (with RG186) or 915 MHz antenna (with RG191)</li> <li>▪ Two 2.4/5 GHz antennas</li> <li>▪ Mounting hardware (wall mount or pole mount available; includes mounting hardware) – sold separately</li> </ul>
Enclosure	<b>IP67 Rated</b>	<ul style="list-style-type: none"> <li>▪ External enclosure housing for Main Gateway PCB</li> <li>▪ Molded plastic cover</li> <li>▪ Anti-corrosive</li> <li>▪ Die Cast Alloy Frame (Al-Si-Mg)</li> </ul>
Warranty		One-year warranty

## 9.2 LED Display Reference

### 9.2.1 Three LED Display with User Button

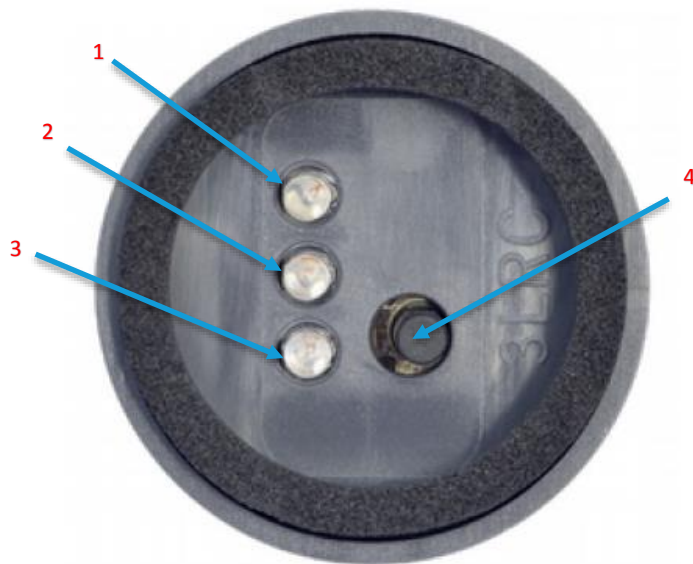

Reference	Description
1	Power (green)
2	LoRa (green)
3	BLE (green)
4	User Button

Figure 42: LED displays with User button (#6 from Figure 41)

### 9.2.2 Six LED Display

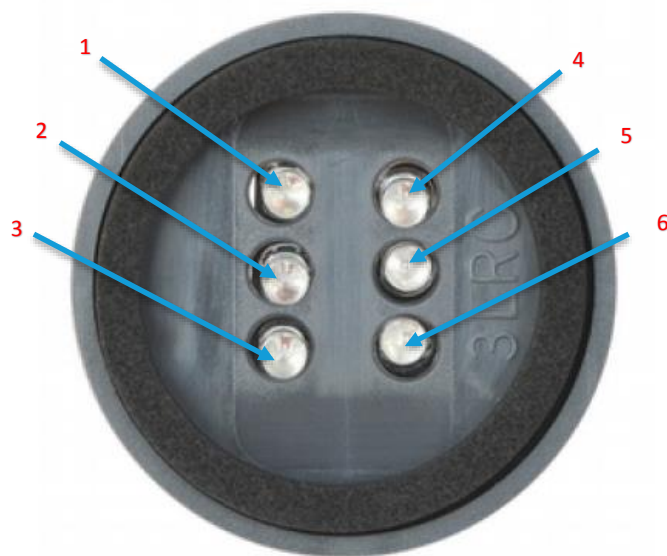

Reference	Description
1	Power
2	Ethernet
3	Wi-Fi
4	N/A
5	User
6	N/A

**Note:** All LEDs are green.

Figure 43: Six LED display (#7 from Figure 41)



### 9.3 Cable Assemblies

#### 9.3.1 Power Supply and Ethernet Module

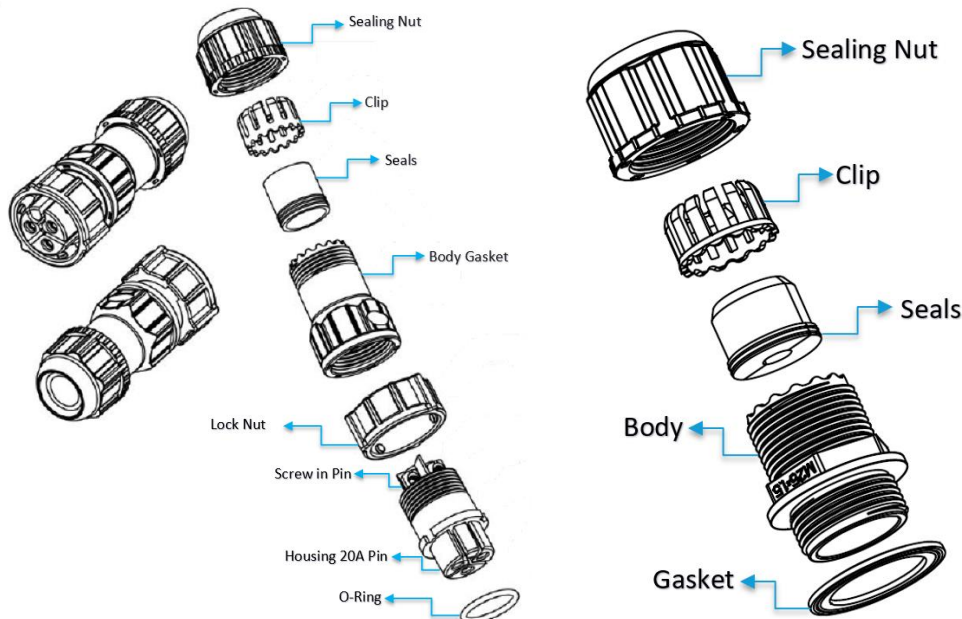

Figure 44: Power cable (left) and Ethernet (right) assembly components

#### 9.3.2 Assembly Steps

The steps explained below cover the power cable assembly process in detail. The ethernet cable assembly is very similar, however less complex, to work with. In general, place the Ethernet cord through each component and mount to the enclosure. Tighten the Sealing Nut with a **Torque Force of 8 ~ 10 kgf.cm**. The rest of the guide covers the power cord assembly.

**Note:** To ensure the IP67 rating, the Ethernet cable diameter must be in the range of 4.5 mm – 6.5 mm. If the cable is too small, there is a potential risk of environment factors potentially damaging the internal hardware.

To assemble the power cable, follow these steps:

1. Insert the Ethernet cord through each component – sealing nut (i), clip (ii), sealing (iii), sealing body (iv), gasket (v), and lock nut (vi) (Figure 45).

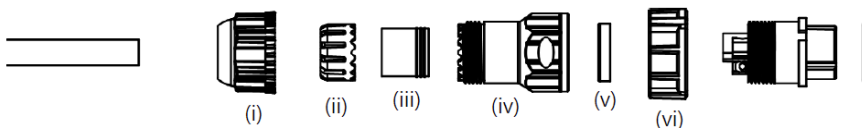

Figure 45: Insert Ethernet cord

**Note:** To ensure the IP67 rating, the **cable diameter must be in the range of 5.5 mm – 8.0 mm**. If the cable is too small, there is a potential risk of environment factors potentially damaging the internal hardware.

- Use a 1.5 mm screwdriver to fix the core wire(s) into the screw fixing point (Figure 46).

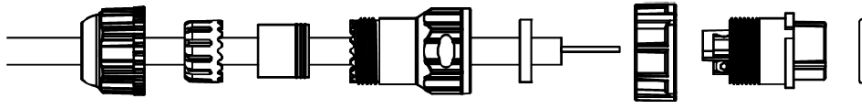
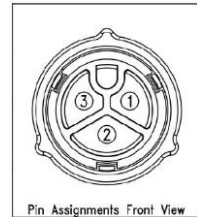

Figure 46: Core wire fixed into the screw fixing point

**Note:** The cable core wires for the power cable assembly need to be in the range of 14 AWG to 18 AWG to fit properly in the screw points. We recommend that you strip and tin the ends of the core cable wires to make the install easier when inserting the wire into the screw points. Range of length tinning wire: 5 mm– 6 mm.

Pin 2 should be negative (black wire) and Pin 1 should be positive (red wire). It is recommended to install an Earth Ground Wire. There are positions available on the enclosure for this (Figure 52).



- Fit the gasket (v), sealing (iii), and clip (ii) onto the sealing body (iv) (Figure 47).
- Fit the lock (vi) and o-ring (ix) onto the housing (vii) (Figure 47).

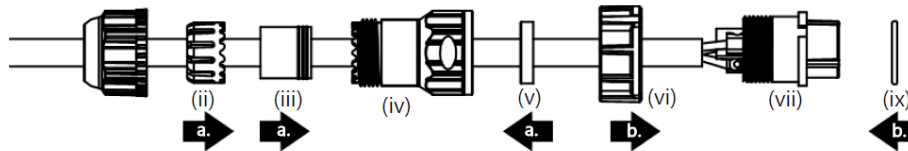

Figure 47: Steps 3 and 4

- Screw the sealing nut (i) and the assembled housing (x) onto the assembled sealing body (xi) with a torque force of 8–10 kgf-cm (Figure 48).

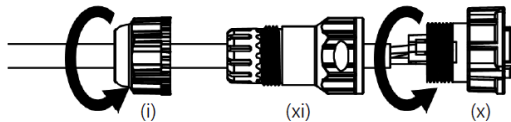

Figure 48: Step 5

The assembly is now complete (Figure).

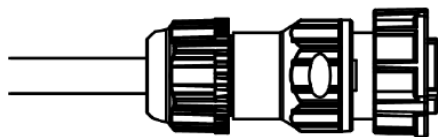

Figure 49: Completed assembly



- Mount the completed cables into the keyed power module slot and the Ethernet module slot #8 and #9 from Figure 41.

## 9.4 Mounting Hardware

### 9.4.1 Wall Mount



#### Included Mounting Hardware

M6x0.8x10.0 mm, stainless steel screws with washers – 4

5/16 x 11 self-tapping screws, L=25.00 mm – 4

3/4" wall anchors – 4

4" hose clamps – 2

M5x1.0x10.0 mm, stainless steel screws with washers (optional) – 4

Figure 50: Wall Mount

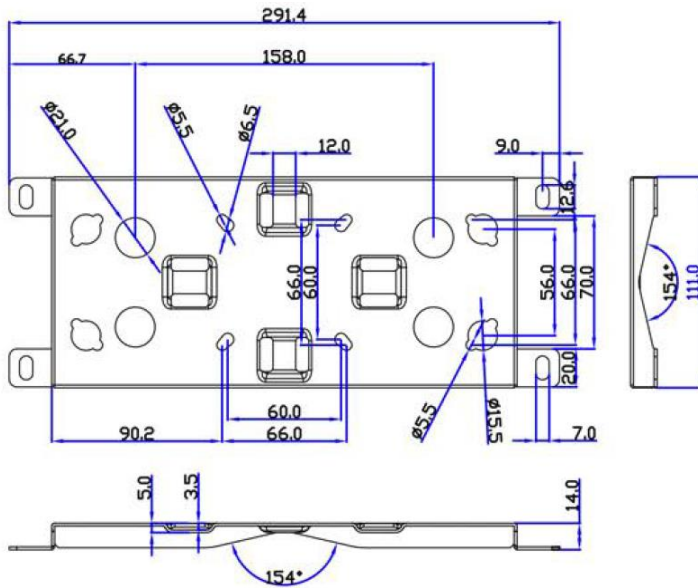

Figure 51: Wall mount dimensions

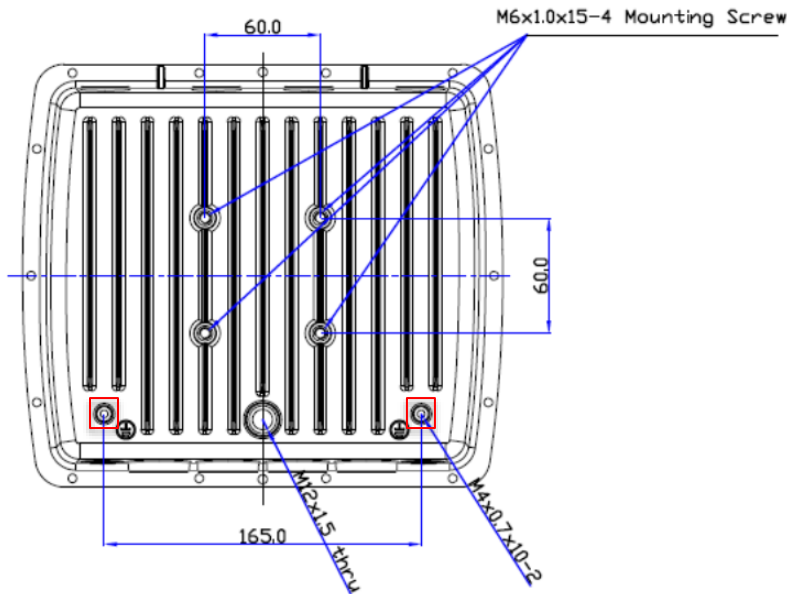

Figure 52: Enclosure placement dimensions (mm)

### 9.4.2 Pole Mount



#### Included Mounting Hardware

M6x0.8x10.0 mm, stainless steel screws with washers – 4

5/16 x 11 Self-tapping screws, L=25.00 mm – 4

3/4" wall anchors – 4

M8x1.25x80.0 mm stainless steel screws with washers – 2

M8x1.25x90.0 mm Stainless Steel Screws with washers and nut – 1

M5x1.0mm Stainless Steel Screws, L = 10.0 mm with washers (optional) – 4

Figure 53: Pole mount (pole diameter range ~34 mm – 90 mm)

#### 9.4.2.1 Dimensions

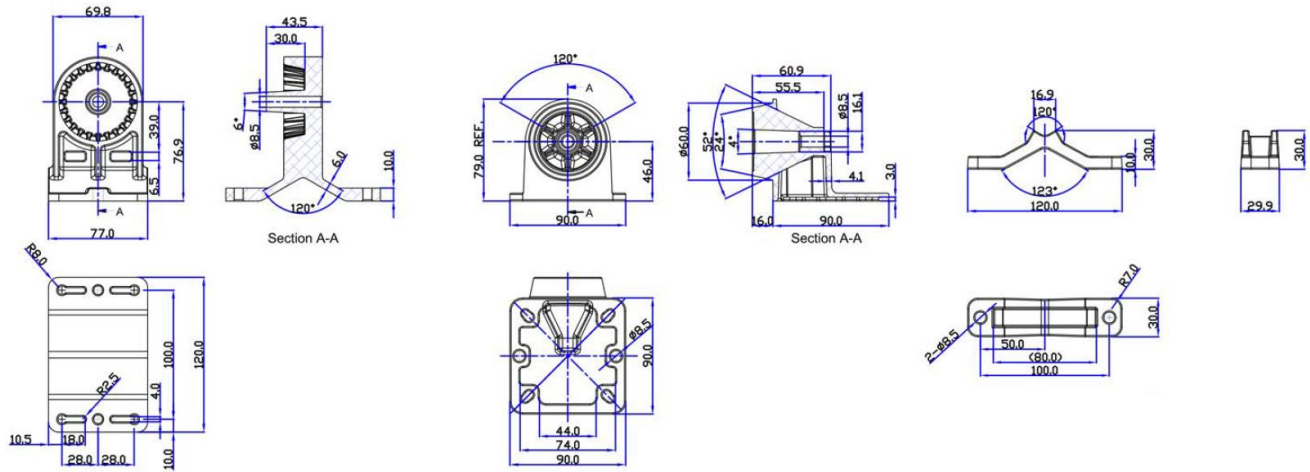

Figure 54: Pole mount dimensions

## 10 FCC AND ISED CANADA REGULATORY STATEMENTS

This product contains the RG191-M2 and the WB50NBT from Laird.

Model	US/FCC	CANADA/IC
RG191-M2	SQG-1001	3147A-1001
WB50NBT	SQG-WB50NBT	3147A-WB50NBT

### 10.1 Power Exposure Information

To comply with FCC RF exposure limits for general population/uncontrolled exposure, the antenna(s) used for this transmitter must be installed to provide a separation distance of at least 20 cm from all persons and operating in conjunction with any other antenna or transmitter.

**IMPORTANT NOTE:** If these conditions cannot be met (for certain configurations or co-location with another transmitter), then the FCC and Industry Canada authorizations are no longer considered valid and the FCC ID and IC Certification Number cannot be used on the final product. In these circumstances, the OEM integrator is responsible for re-evaluating the end product (including the transmitter) and obtaining a separate FCC and Industry Canada authorization.

### 10.2 OEM Responsibilities

To comply with FCC and Industry Canada RF exposure limits for general population/uncontrolled exposure, the antenna(s) used for this transmitter must be installed to provide a separation distance of at least 20 cm from all persons and operating in conjunction with any other antenna or transmitter, except in accordance with FCC multi-transmitter product procedures.

---

**WARNING:** Changes or modifications not expressly approved by Laird could void the user's authority to operate the equipment.

---

#### 10.2.1 FCC Interference Statement

This equipment has been tested and found to comply with the limits for a Class B digital device, pursuant to Part 15 of the FCC Rules. These limits are designed to provide reasonable protection against harmful interference in a residential installation. This equipment generates, uses, and can radiate radio frequency energy and, if not installed and used in accordance with the instructions, may cause harmful interference to radio communications. However, there is no guarantee that interference will not occur in an installation. If this equipment does cause harmful interference to radio or television reception, which can be determined by turning the equipment off and on, the user is encouraged to correct the interference by one or more of the following measures:

- Re-orient or relocate the receiving antenna
- Increase the separation between the equipment and the receiver
- Connect the equipment to an outlet on a circuit different from that to which the receiver is connected.
- Consult the dealer or an experienced radio/TV technician for help.

#### 10.2.2 FCC Warning

This device complies with part 15 of the FCC rules operation is subject to the following two conditions: (1) this device may not cause harmful interference, and (2) this device must accept any interference received, including interference that may cause undesired operation.

### 10.2.3 Industry Canada (IC) Warning

This device complies with Industry Canada license-exempt RSS standard(s). Operation is subject to the following two conditions: (1) this device may not cause interference, and (2) this device must accept any interference, including interference that may cause undesired operation of the device.

French equivalent is:

Le présent appareil est conforme aux CNR d'Industrie Canada applicable aux appareils radio exempts de licence. L'exploitation est autorisée aux deux conditions suivantes : (1) l'appareil ne doit pas produire de brouillage, et (2) l'utilisateur de l'appareil doit accepter tout brouillage radioélectrique subi, même si le brouillage est susceptible d'en compromettre le fonctionnement.

### 10.2.4 ISED Radiation Exposure Statement

To comply with ISED Canada RF exposure limits for general population / uncontrolled exposure, the antenna(s) used for this transmitter must be installed to provide a separation distance of at least 20 cm from all persons and must not be operating in conjunction with any other antenna or transmitter.

French equivalent is:

Déclaration IC d'exposition aux radiations

Pour se conformer à Industrie Canada RF limites d'exposition pour la population générale / exposition non contrôlée, l'antenne utilisée pour ce transmetteur doit être installée pour fournir une distance d'au moins 20 cm de toutes les personnes et ne doit pas fonctionner en conjonction avec toute autre antenne ou transmetteur.

## 11 CE REGULATORY

The RG186 has been tested for compliance with relevant standards for the EU market.

Reference the Declaration of Conformities listed below for a full list of the standards that the modules were tested to. Test reports are available upon request.

## 12 EU DECLARATIONS OF CONFORMITY

<b>Manufacturer</b>	Laird	
<b>Products</b>	RG186	
<b>Product Description</b>	LoRa/Wi-Fi/BT and BLE RF Module	
<b>EU Directives</b>	2014/53/EU – Radio Equipment Directive (RED)	

### Reference standards used for presumption of conformity:

Article Number	Requirement	Reference standard(s)
3.1a	Health and Safety	EN60950-1:2006+A2:2013
3.1b	Protection requirements – Electromagnetic compatibility	EN 301 489-1 v2.2.0 (2017-03) EN 301 489-3 v2.1.1 (2017-03) EN 301 489-17 v3.2.0 (2017-03)
3.2	Means of the efficient use of the radio frequency spectrum (ERM)	EN 300 220-1 v3.1.1 (2017-02) EN 300 220-2 v3.1.1 (2017-02) EN 300 328 v2.1.1 (2016-11) EN 301 893-v2.1.1 (2017-05)

### Declaration:

We, Laird, declare under our sole responsibility that the essential radio test suites have been carried out and that the above product to which this declaration relates is in conformity with all the applicable essential requirements of Article 3 of the EU Radio Equipment Directive 2014/53/EU, when used for its intended purpose.

Place of Issue:	Laird W66N220 Commerce Court, Cedarburg, WI 53012 USA tel: +1-262-375-4400 fax: +1-262-364-2649
Date of Issue:	20 Dec 2017
Name of Authorized Person:	Thomas T Smith, Director of EMC Compliance
Signature of Authorized Person:	