

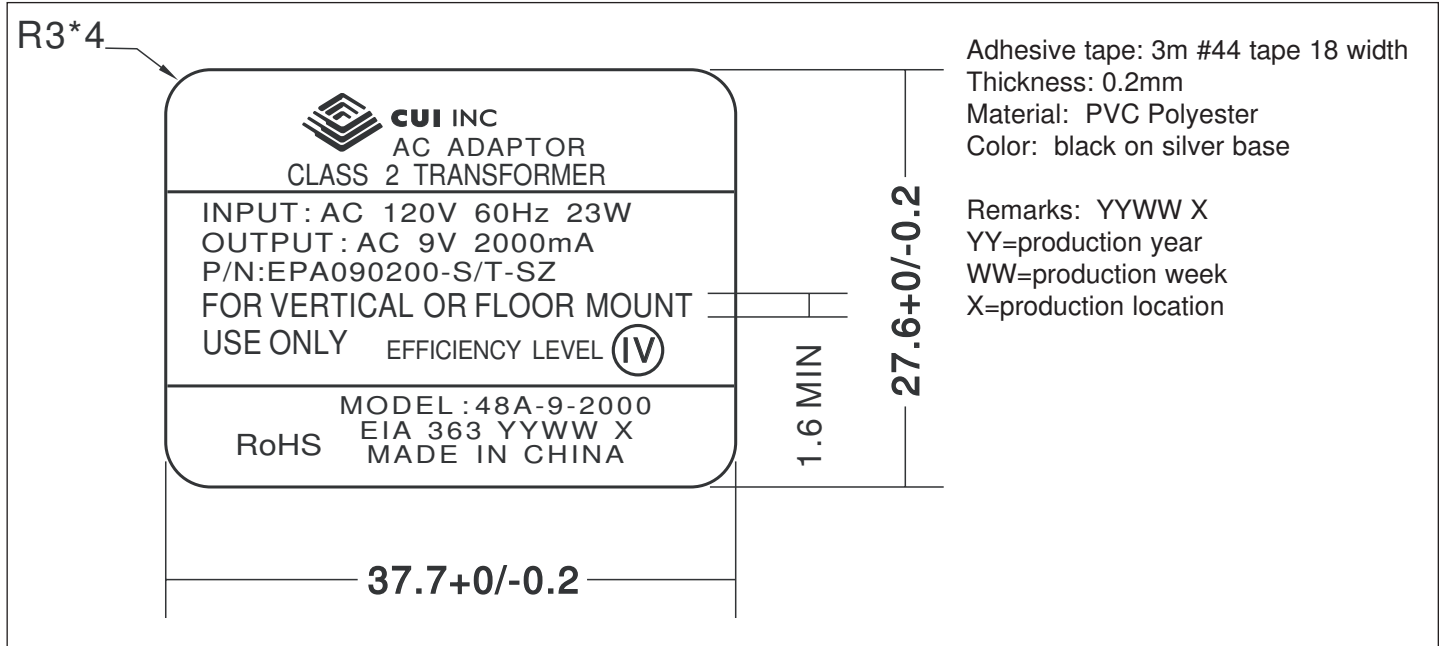

Specifications

Output voltage	9 V ac at 2000 mA	
Rated input voltage	120 V ac	
Primary rated voltage	120 V ac 60 Hz 23 W	
Primary exciting current	30 mA rms max.	
Secondary rated voltage & current	no load voltage (max.)	11.1 V ref
	full load voltage (2000 mA)	9 V \pm 5%
Temperature rise of primary winding (full load)	70°C max. using resistance method	
Insulation resistance	\geq 100 M Ohm at 500 V dc	
HI-POT test	from input to output for 1 min.	1240 V ac at 2 mA
	from input to output for 1 sec.	1600 V ac at 2 mA
	from primary to secondary winding for 1 sec.	1600 V ac at 2 mA
	from primary winding to core for 1 sec.	1600 V ac at 2 mA
	from secondary winding to core for 1 sec.	750 V ac at 2 mA
Safety standards	UL/cUL	
RoHS compliant	yes	
No load power consumption	0.5 W max.	
Efficiency	Energy Star Compliant - Efficiency Level IV	
Test conditions	Ambient temp	40°C \pm 2°C
	Humidity	90-95% 96 hours at Full Load
	Rated voltage	8 hours at full load
Adapter color	Case	black
	Cord	black



Label



Mechanical Drawing

 Tolerance: ± 1

Weight

520 g

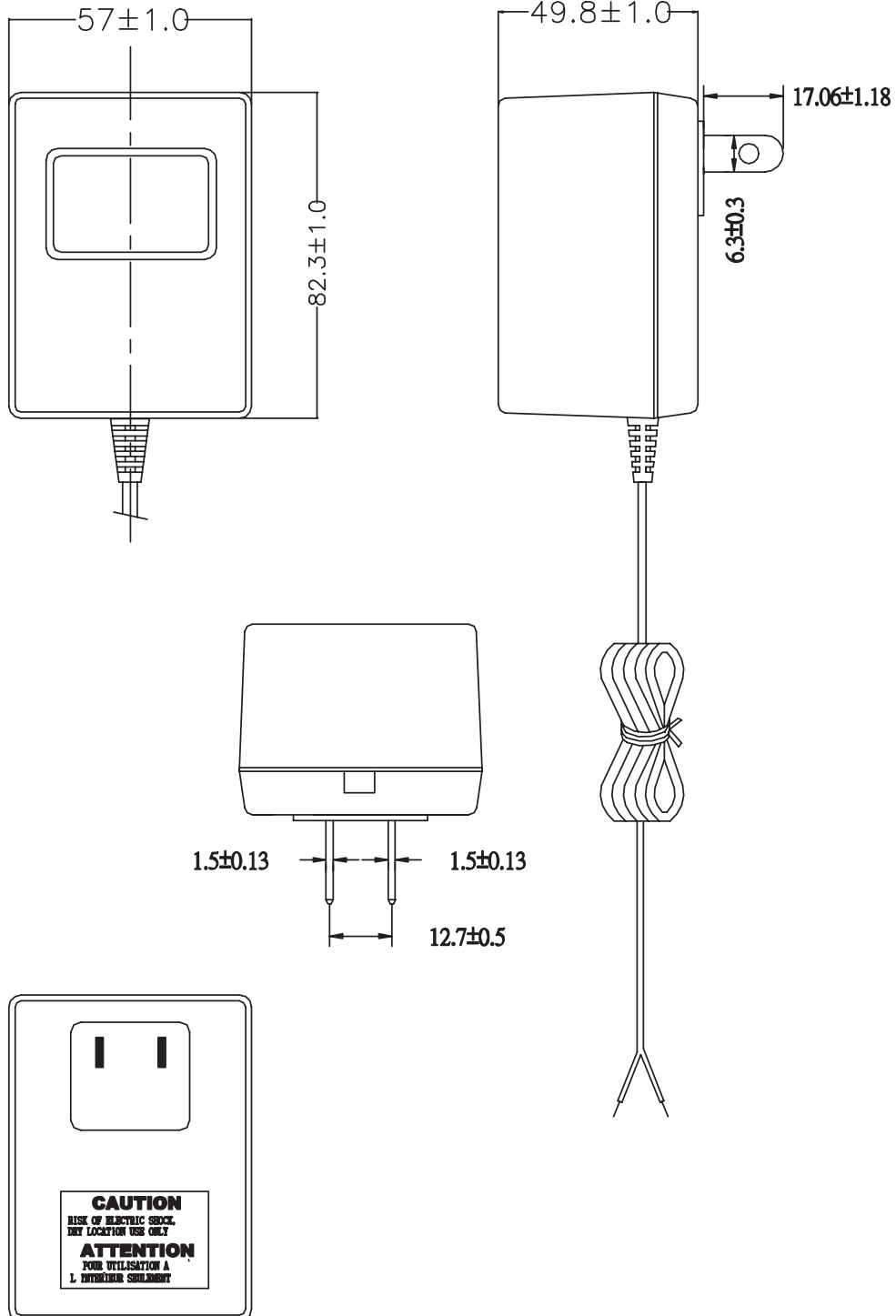



DC Cord

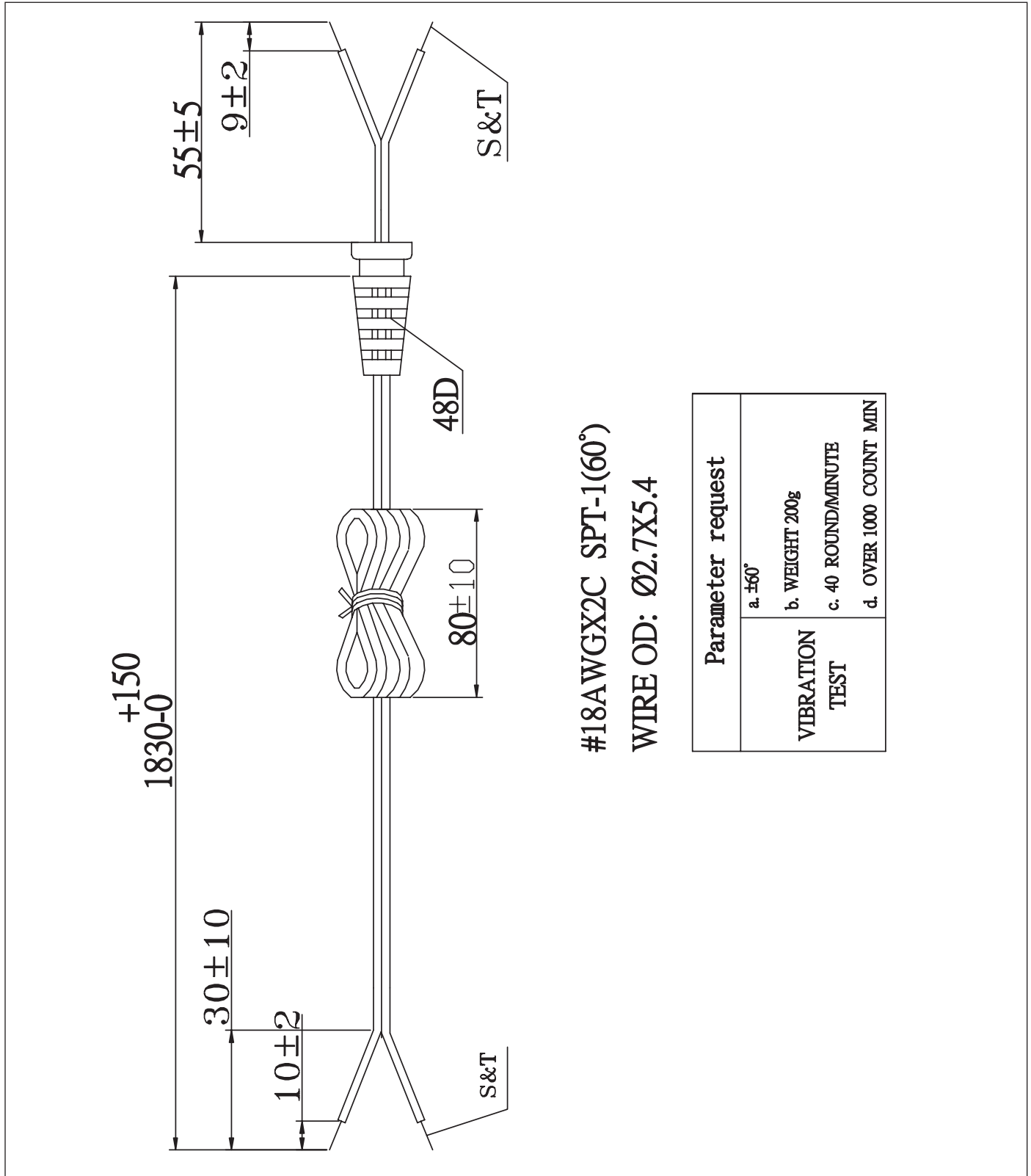

#18AWGX2C SPT-1(60°)

WIRE OD: Ø2.7X5.4

Parameter request	
a. ±60°	VIBRATION TEST
b. WEIGHT 200g	
c. 40 ROUND/MINUTE	
d. OVER 1000 COUNT MIN	

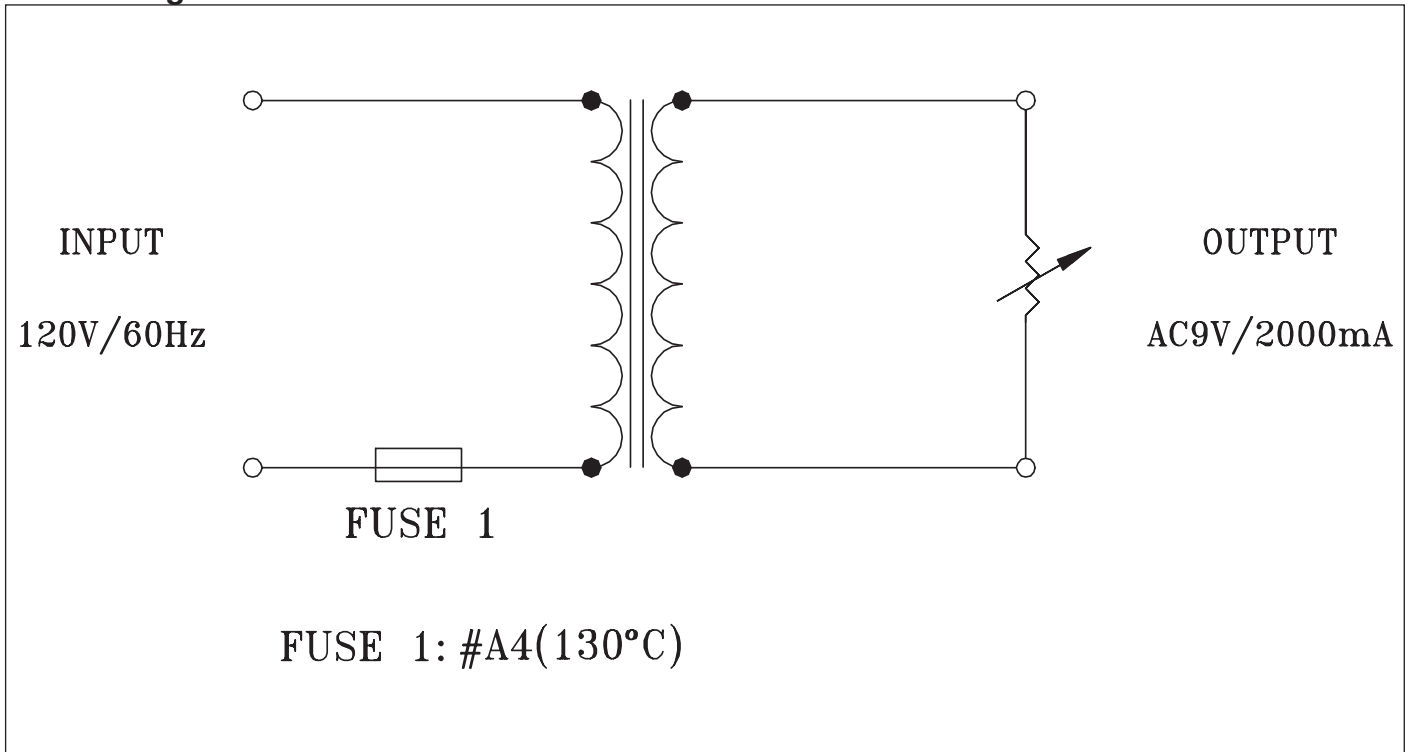
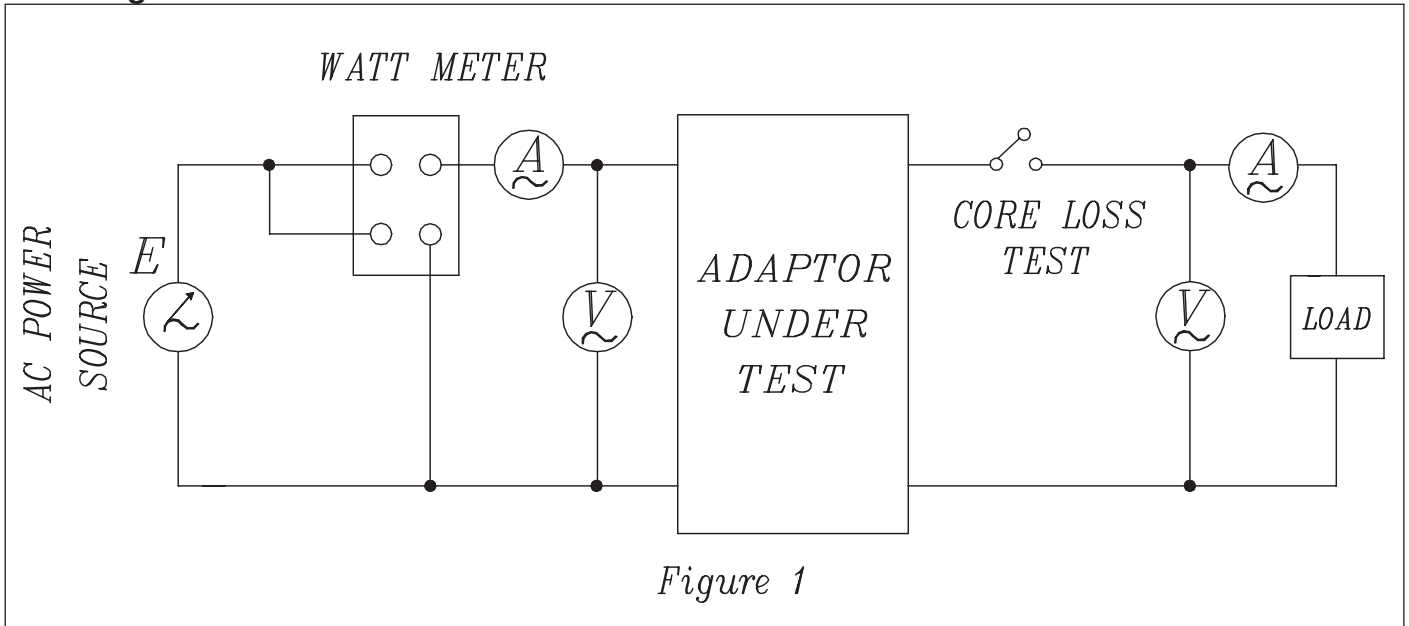
Circuit Diagrams

Test Diagram

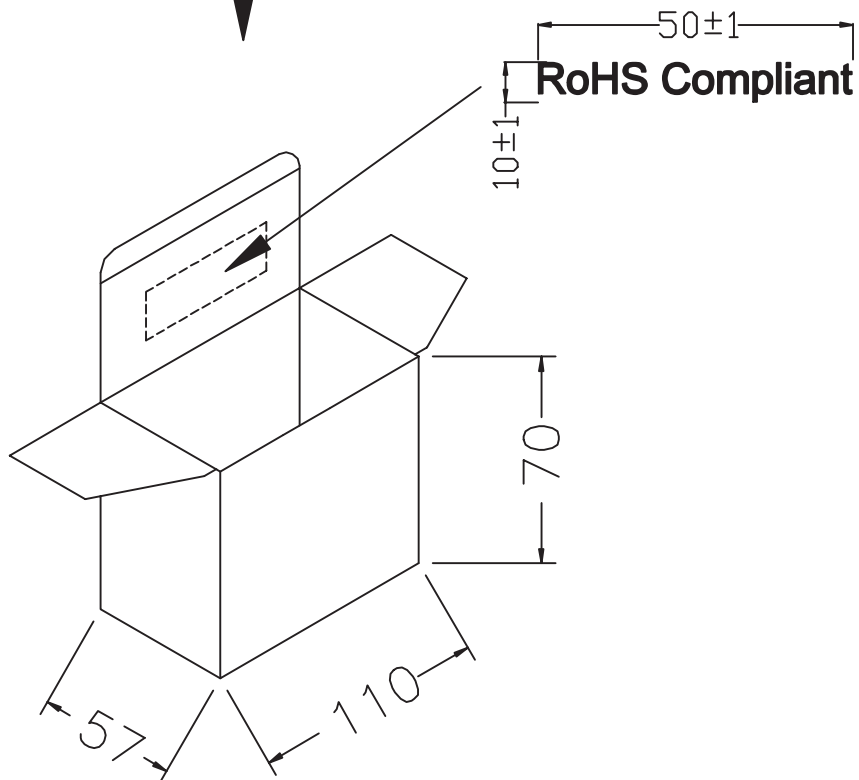
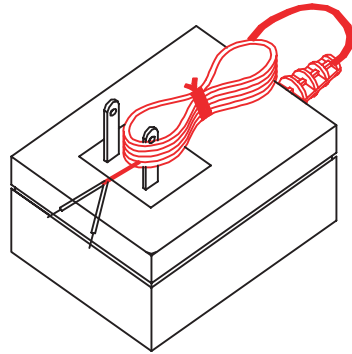

Individual Packaging

Tolerance: ± 1





Packaging

Tolerance: +7/-0

CARTON SIZE: 377X355X147mm

Q'TY: 30pcs(15x2)

N.W:15.6KGS

G.W:16.6KGS

G.W:17.1KGS

