

LT1370 6A Switch

2.7V to 12V Input

5V or 12V Output

DESCRIPTION

Demonstration board DC185 is a complete DC/DC step-down regulator using the LT[®]1370 constant frequency, high efficiency converter in a 7-pin DD package. High

frequency switching allows the use of small inductors, making this all surface mount solution ideal for space-conscious systems.

LT, LTC and LT are registered trademarks of Linear Technology Corporation.

PERFORMANCE SUMMARY

$T_A = 25^\circ\text{C}$, $V_{IN} = 5\text{V}$, $I_{LOAD} = 1\text{A}$, $V_{OUT} = 12\text{V}$ (jumper J1 removed), S/D pin open, unless otherwise specified.

| PARAMETER | CONDITIONS | MIN | TYP | MAX | UNITS |
|---------------------------|---|------|------|------|-------------------|
| Output Voltage | Jumper J1 Removed (Note 1) | 11.6 | 12.0 | 12.4 | V |
| | Jumper J1 Inserted | 4.85 | 5.00 | 5.17 | V |
| Maximum I_{SW} | | 6 | 8 | 10 | A |
| Input Voltage Range | (Note 2) | 2.7 | | 12 | V |
| Switching Frequency | | 440 | 500 | 580 | kHz |
| Output Ripple Voltage | | | 80 | | mV _{p-p} |
| Line Regulation | $V_{IN} = 2.7\text{V to }11\text{V}$, $I_{LOAD} = 0.5\text{A}$ | | 20 | | mV |
| Load Regulation | $I_{LOAD} = 10\text{mA to }1.75\text{A}$ | | 18 | | mV |
| S/D Shutdown Threshold | | 0.6 | 1.3 | 2 | V |
| S/D Synchronization Range | | 600 | | 800 | kHz |
| Supply Current | S/D = 0V, $I_{LOAD} = 0\text{A}$ (Note 3) | | 100 | | μA |

Note 1: Output voltage variations include $\pm 1\%$ tolerance of feedback divider network. For tighter voltage range, use lower tolerance resistors.

Note 2: With the boost topology, input voltage must always be lower than output voltage. See the LT1370 data sheet for maximum device ratings.

Note 3: The boost topology provides a path from input to output even with the LT1370 in shutdown. Applications are available that remove this direct path and reduce shutdown supply current to $12\mu\text{A}$, independent of loading.

TYPICAL PERFORMANCE CHARACTERISTICS AND BOARD PHOTO

Output Efficiency

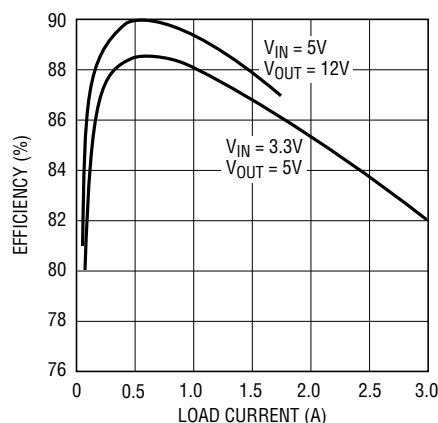

DM185 G01

Maximum Load Current vs Input Voltage

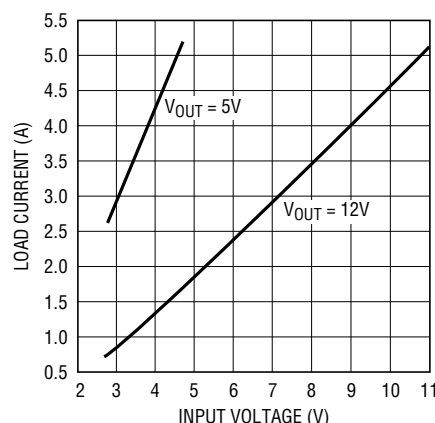

DM185 G02

Component Side



DC185 BP

PACKAGE A MD SCHEMATIC DIAGRAMS

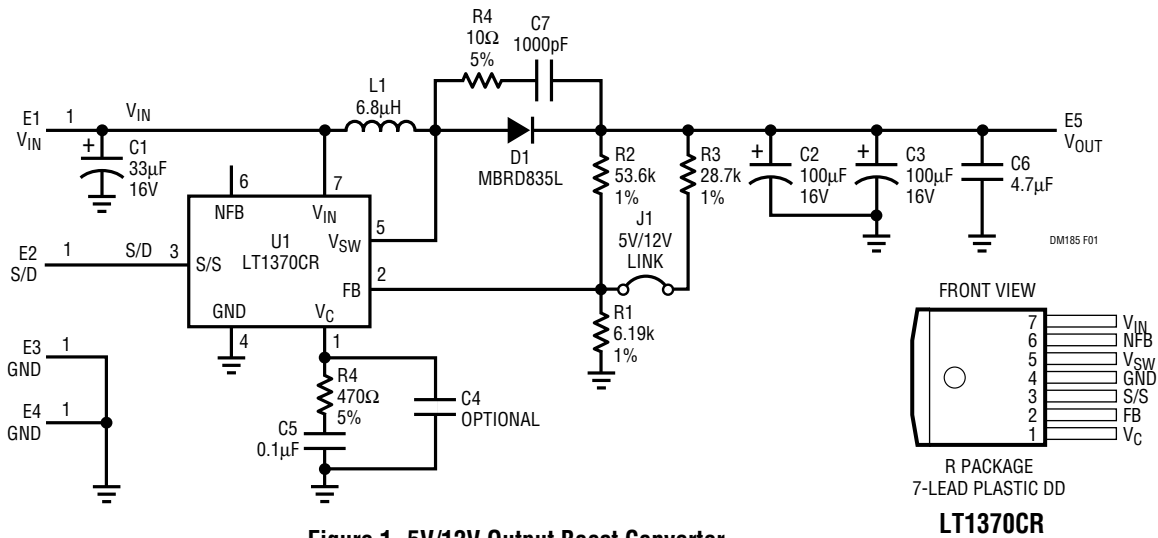

Figure 1. 5V/12V Output Boost Converter

PARTS LIST

| REFERENCE DESIGNATOR | QUANTITY | PART NUMBER | DESCRIPTION | VENDOR | TELEPHONE |
|----------------------|----------|----------------|--------------------------------------|----------|----------------|
| C1 | 1 | T495D336M016AS | 33µF 16V Tantalum Capacitor, Case-D | Kemet | (714) 640-9320 |
| C2, C3 | 2 | T495X107M016AS | 100µF 16V Tantalum Capacitor, Case-D | Kemet | (714) 640-9320 |
| C4 | 1 | Optional | | | |
| C5 | 1 | 08055C104MAT3S | 0.1µF 50V X7R Chip Capacitor, 0805 | AVX | (803) 946-0362 |
| C6 | 1 | 1206YG475MAT3S | 4.7µF 16V Y5V Chip Capacitor, 1206 | AVX | (803) 946-0362 |
| C7 | 1 | 08053A102KAT | 1000pF, 25V NPO Chip Capacitor, 0805 | AVX | (803) 946-0362 |
| D1 | 1 | MBRD835L | SMT Diode, D-Pak | Motorola | (602) 244-3576 |
| E1 to E5 | 5 | 2501-2 | Pad Turret, PAD.092 | Mill-Max | (516) 922-6000 |
| R1 | 1 | CR10-6191F-T | 6.19k 1/8W 1% Chip Resistor, 0805 | TAD | (800) 508-1521 |
| R2 | 1 | CR10-5362F-T | 53.6k 1/8W 1% Chip Resistor, 0805 | TAD | (800) 508-1521 |
| R3 | 1 | CR10-2872F-T | 28.7k 1/8W 1% Chip Resistor, 0805 | TAD | (800) 508-1521 |
| R4 | 1 | CT10-471J-T | 470Ω 1/8W 5% Chip Resistor, 0805 | TAD | (800) 508-1521 |
| R5 | 1 | CR10-100J-T | 10Ω 1/8W 5% Chip Resistor, 0805 | TAD | (800) 508-1521 |
| L1 | 1 | 501-0726 | 6.8µH 20% Inductor, Qtr-Pak | BH-Elec | (612) 894-9590 |
| J1 | 1 | 2802S-02-G2 | 0.079" Center 2-Pin Header | Comm Con | (818) 301-4200 |
| J1 | 1 | CCIJ2MM-138-G | 0.079" Center 2-Pin Shunt | Comm Con | (818) 301-4200 |
| U1 | 1 | LT1370CR | 7-Lead DD IC | LTC | (408) 432-1900 |

OPERATION

DC185 Operation

The DC185 demonstration board is intended for evaluating the LT1370 switching regulator in a typical step-up application. Solid turret terminals are provided for easy connection to test equipment. A device pinout and board schematic are shown in Figure 1. Please refer to the

LT1370 data sheet for additional specifications and applications information. You may find Linear Technology's SwitcherCAD™ software helpful for creating your own designs.

SwitcherCAD is a trademark of Linear Technology Corporation.

OPERATION

Hook-Up

Connect the input supply and measurement instruments to the V_{IN} and GND terminals. The S/D pin (synchronization/shutdown) can be connected to V_{IN} or left open. Connect the output load and measurement instruments to the V_{OUT} and GND terminals.

LT1370 Operation

The LT1370 is a monolithic, high frequency, current mode switcher. The part can operate from an input supply range of 2.7V to 30V (DC185 maximum $V_{IN} = 12V$) and draws only 4.5mA quiescent current. The on-chip current limited power switch is guaranteed to 6A minimum switch current with a 0.065Ω typical “on” resistance and a 35V minimum breakdown voltage. The switch, which operates at a fixed frequency of 500kHz, can also be easily synchronized to a higher frequency by driving the S/D pin with a logic-level source. Shutdown is activated by holding the S/D pin below 0.6V, which reduces device supply current to 40 μ A maximum.

Under normal operating conditions, a 1.245V reference voltage is developed at the Feedback pin. The output voltage is set by R1 and R2, where $V_{OUT} = V_{REF} (1 + R2/R1)$. Although not used in this application, the part also has a Negative Feedback pin (NFB), which can be used to set the output voltage of positive-to-negative converters. When in use, a $-2.48V$ reference voltage is developed at the NFB pin.

The V_C pin is the output of the error amplifier. During normal regulator operation, this pin sits at a voltage between 1V (low output current) and 1.9V (high output current). Loop frequency compensation is performed at the V_C pin via an RC network to ground.

COMPONENTS

Inductor

The inductor is a BH Electronics 501-0726, a 6.8 μ H toroidal ferrite unit. It was selected for its small size, low EMI, low DCR and 5A I_{SAT} rating.

Capacitors (and Input/Output Ripple Voltage)

The capacitors on this board are low ESR (effective series resistance) tantalum units specifically designed for switch

mode power supply applications. At these high frequencies, input and output ripple voltages are more a function of the ESR of the capacitor than of the capacitance value. For example, at 500kHz a 100 μ F capacitor has a capacitive reactance of only 0.003Ω , which is much lower than the limiting 0.1Ω maximum ESR of the capacitors used. Therefore, if a reduction in input or output ripple voltage is required, use two or more capacitors in parallel instead of a larger value capacitor. If very low output ripple voltage is needed, adding an output LC filter may be a cheaper solution. The output contains very narrow voltage spikes because of the parasitic inductance of the output capacitor. Due to their high frequency nature, the amplitude of the spikes is determined by the ESL (effective series inductance) of the output capacitor. But this also makes them easy to filter. Small 0.1 μ F ceramic chip capacitors work well in reducing the spikes. If trace connections to the load are a few inches or more in length, the parasitic inductance, combined with any local load bypass capacitor, will virtually eliminate the spikes at the load.

Snubber

R4 and C7 form a snubber network across the catch diode, D1. This reduces the spikes seen on the output due to ringing of the catch diode on switching edges. The snubber reduces efficiency typically by 0.5%. Trace inductance and decoupling capacitors on the application board may remove the need for a snubber network.

Diodes

Use diodes designed for switching applications, with adequate current rating and fast turn-on times, such as Schottky or ultrafast diodes. In selecting a diode, the basic parameters of interest are forward voltage, maximum reverse voltage, average operating current and peak current. Lower forward voltage yields higher circuit efficiency and lower power dissipation in the diode. The worst-case reverse voltage is equal to the output voltage. The average diode current will be equal to the output current, but the peak diode current can be many times higher than the output current. Except for output short-circuit conditions, peak diode current is limited to the switch current limit of 7.5A maximum.

DEMO MANUAL DC185

OPERATION

Thermal Considerations

Care should be taken to ensure that the worst-case input voltage and load current conditions do not cause excessive die temperatures. Please consult the LT1370 data sheet or Linear Technology's SwitcherCAD software for more information.

PCB Layout

In many cases, the circuit area traces of the demonstration board may be dropped directly into your PCB layout. If not,

there are a few things to be aware of with high frequency converter layouts. Keep the traces connecting the Switch (Pin 5), output diode, output capacitor and ground return path (Pin 4 and Tab) as short as possible. This will reduce RFI and limit the voltage spikes caused by parasitic inductance. Keep the more sensitive components, mainly the feedback resistors and V_C pin network, away from the high current switching components.

PCB LAYOUT AND FILM

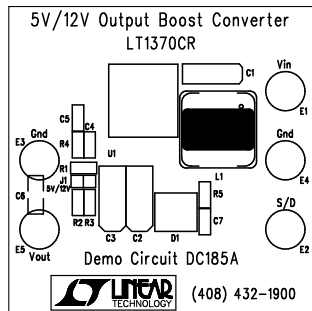

Silkscreen Top

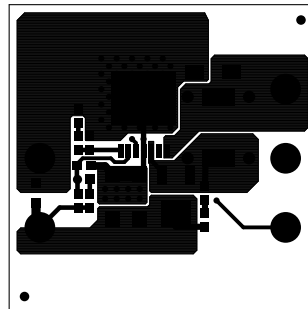

Component Side

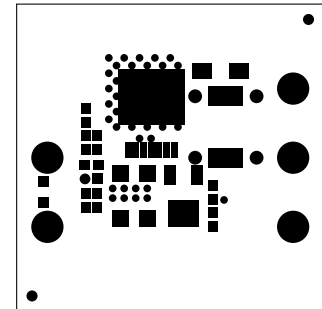

Solder Mask Top

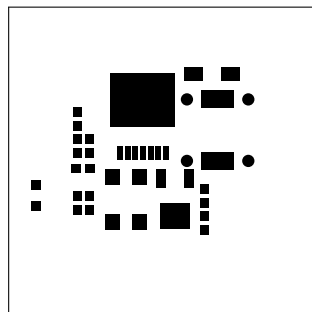

Paste Mask Top

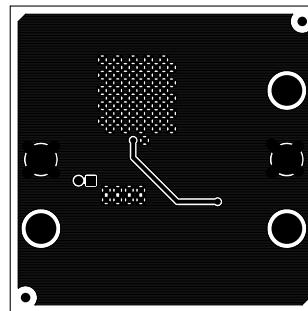

Solder Side

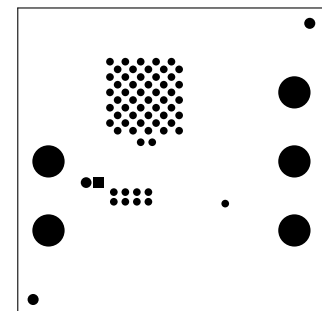

Solder Mask Bottom

PC FAB DRAWING

| SYMBOL | DIAMETER | # OF HOLES | PLATED |
|-------------|----------|------------|--------|
| A | 0.020 | 58 | Yes |
| B | 0.037 | 2 | Yes |
| C | 0.025 | 3 | Yes |
| D | 0.072 | 2 | No |
| E | 0.095 | 5 | Yes |
| TOTAL HOLES | | 70 | |

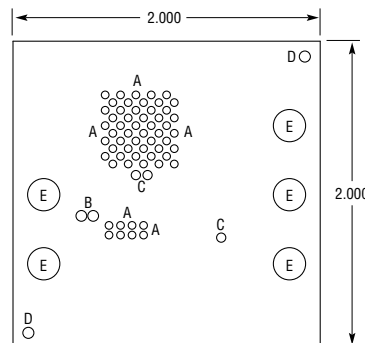

NOTES: UNLESS OTHERWISE SPECIFIED

1. MATERIAL: FR4 OR EQUIVALENT EPOXY, 2 OZ COPPER CLAD THICKNESS 0.062 ± 0.006 TOTAL OF 2 LAYERS
2. FINISH: ALL PLATED HOLES 0.001 MIN/0.0015 MAX COPPER PLATE ELECTRODEPOSITED TIN-LEAD COMPOSITION BEFORE REFLOW, SOLDER MASK OVER BARE COPPER (SMOBC)
3. SOLDER MASK: BOTH SIDES USING GREEN PC-401 OR EQUIVALENT
4. SILKSCREEN: USING WHITE NONCONDUCTIVE EPOXY INK
5. ALL DIMENSIONS ARE IN INCHES