



CAUTION: READ MANUAL BEFORE OPERATING COOLING UNIT

- Input power must be rated 230 VAC at 50/60 Hz
- Use Water or Water/Glycol as coolant
- Run the cooling unit at the correct coolant level, otherwise the cooling capacity will be reduced
- Clean the filter periodically, otherwise the pump may degrade over time
- Use cooling hoses that can handle max pressure of the liquid circuit and is resistant to corrosion from coolant
- Never operate the unit if it is damaged or leaking
- Before starting any service work on the cooling unit, please disconnect from the main power source.

global solutions: local support™

Americas: +1.888.246.9050

Europe: +46.31.704.67.57



Asia: +86.755.2714.1166

TABLE OF CONTENTS

| | Pg No. |
|-----------------------------------|--------|
| 1 Description | 2 |
| 2 Technical Data | 3 |
| 2.1 Physical Dimensions | 3 |
| 2.2 Performance Data | 3 |
| 2.3 Environmental Specifications | 3 |
| 2.4 Settings | 3 |
| 3 Setting to Work | 4 |
| 4 Settings | 5 |
| 4.1 Flow Switch | 5 |
| 4.2 System Pressure | 5 |
| 5 Maintenance | 6 |
| 5.1 Heat exchanger | 6 |
| 5.2 Pump | 6 |
| 6 Spare Part List | 7 |
| 7 Performance Diagram | 8 |
| 8 Liquid and Electronic Schematic | 9 |

DESCRIPTION

The WL 1000 cooling unit is intended to remove heat from a liquid circuit. The coolant can be either water or a mixture of water and water-glycol (antifreeze). Water circulates in a closed loop between the ambient cooling system and a cold plate at the heat source. Heat is removed from water by an air-cooled heat exchanger. The capacity of the cooling unit is dependent on the temperature differential, which is defined as the difference between the ambient temperature and the water outlet temperature. The cooling unit is designed to remove 1000 W of heat at a temperature differential of 11.6°C. The water inlet and water outlet are marked with the following symbols:

Inlet: ; outlet: 

The maximum forward pressure is limited by a bypass valve, which has been integrated into the pump. The coolant flow is controlled by a flow switch that opens when flow falls below a set rate. Cooling hoses supplied by user are connected to threaded nozzle that can accommodate a 12mm hose ID.

2 TECHNICAL DATA

2.1 PHYSICAL DIMENSIONS

- Length: 330 mm
- Width: 292 mm
- Height: 300 mm
- Weight: 17.0 kg without filling
- Coolant Capacity: 1.5 L

2.2 PERFORMANCE DATA

- Cooling Capacity: 1000 W
- Flow Rate: ≥ 4.4 l/min at 4.0 bar
- Supply Voltage: 230 V 50/60 Hz
- Current Consumption: ≤ 2 A
- Noise Level: ≤ 70 dB(A), 1 m distance

2.3 ENVIRONMENTAL SPECIFICATIONS

- Operating Temperature: $+ 10^{\circ}\text{C}$ to 40°C
(use antifreeze if ambient temperature is below 10°C)
- Storage Temperature: -40°C to 70°C
(storage with antifreeze)
- Air Humidity: 20% to 80%

2.4 SETTINGS

- Temperature Regulator: $50^{\circ}\text{C} \pm 3^{\circ}\text{C}$ (unit out) hysteresis $< 10^{\circ}\text{C}$
- Flow Switch Opens: 4.0 l/min ± 0.3 l/min
- Maximum System Pressure: 6.0 bar

3 SETTING TO WORK

1. Position cooling unit horizontally and keep obstructions away from air inlet to allow for sufficient air circulation.
2. Remove the reservoir cap.
3. Connect the external hoses supplied by the user.
4. Insert the cable and connect it to the terminals according to the terminal diagram; use a 3 mm screwdriver to connect the wires to terminal block.
5. Fill the cooling unit with approximately 1.5 L of coolant.

Note: The coolant level must be approximately 3 cm above fins to maintain peak cooling performance, otherwise the cooling capacity will be reduced.

6. Allow the cooling unit to run for 10 minutes and deaerate the liquid circuit.
7. Check the coolant level. If necessary, refill the coolant.
8. Replace the reservoir cap.



4 SETTINGS

4.1 Flow Switch

The flow switch is set to open at 4 lpm. If it is necessary to adjust this setting then perform the following:

1. Disconnect the cooling unit from the main power source.
2. Remove the complete cover.
3. Open the setscrew.
4. Increase the flow rate set point by shifting the plate in the direction of flow or decrease the flow rate set point by shifting the plate opposite of the direction of flow.
5. Fix the setscrew.

4.2 System Pressure

The maximum system pressure has been adjusted at factory to specification (at 60 Hz). If it is necessary to adjust this setting then perform the following:

1. Disconnect the cooling unit from the main power source
2. Remove the complete cover
3. Increase the maximum pressure by turning the setscrew clockwise or reduce the maximum pressure by turning the setscrew counter clockwise.

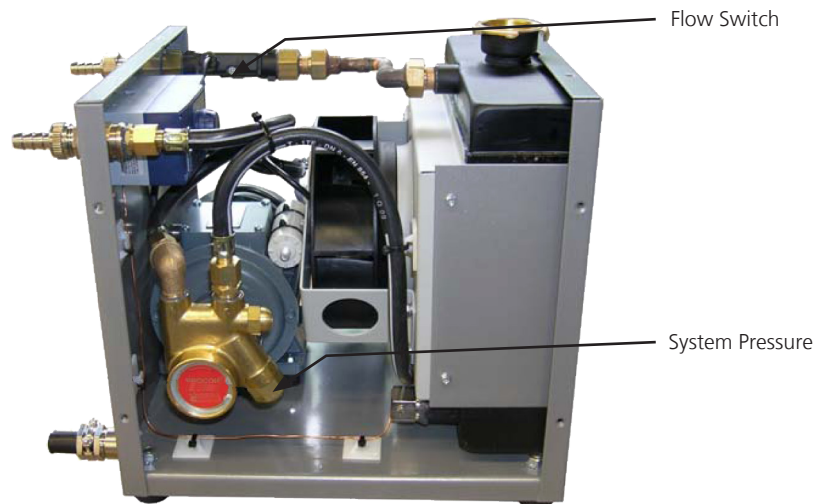

5 MAINTENANCE

Check the coolant level and antifreeze regularly and refill if necessary.

5.1 HEAT EXCHANGER

In order to achieve maximum cooling capacity the heat exchanger of the cooling unit must be kept clean. Check heat exchanger every 3 months for cleanliness. If cleaning is required perform the following:

1. Disconnect the cooling unit from the the main power source.
2. Remove the side cover.
3. Clean the heat exchanger with compressed air, a damp cloth or a shop vacuum.
4. Mount the side cover.

5.2 PUMP

The pump has incorporated a coolant filtering mechanism to keep debris out of the pump. It is recommended to check the filter every three months to make sure it is clean. If cleaning is required, then perform the following:

Note: If the filter is not cleaned, then degradation to the pump may occur.

1. Disconnect cooling unit from main power source and external hoses
2. Drain coolant from reservoir
3. Remove side cover
4. Position cooling unit on side opposite to pump. This will limit coolant leaking from system.
5. Unscrew filter cap with wrench that can accommodate 24 mm nut.

Note: Some coolant may run out from pump. Collect in suitable container.

6. Remove filter and clean with mild soap and water or replace
7. Insert filter into housing and tighten nut
8. Mount side cover and reposition cooling unit on legs
9. Refill coolant in reservoir and run for 10 minutes to deaerate. Check coolant level and refill if necessary.

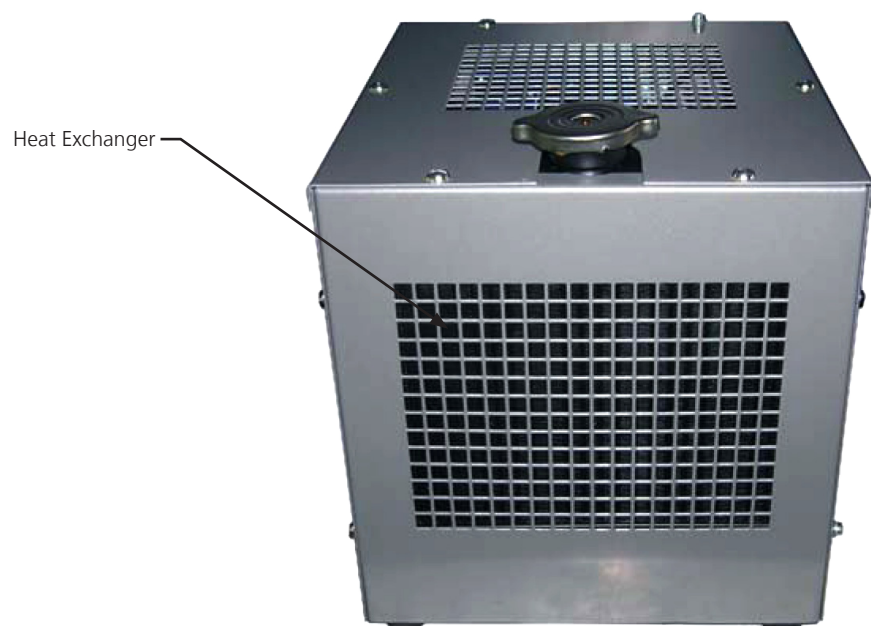

WL 1000

Liquid Cooling System

USER MANUAL

6 PLACING OUT OF OPERATION

1. Disconnect the cooling unit from the main power source.
2. Remove the electrical connections.
3. Remove the hoses from the cooling unit.
4. Remove the cap and drain the coolant in a suitable container.
5. Mount the cap on the drain.

7 SPARE PARTS LIST AND ILLUSTRATION

| NO. | DESCRIPTION | CODE NUMBER |
|-----|--|-------------|
| 1 | Flow switch Novafix FW1-15 | 2004964 |
| 2 | Set of hose nipples complete \varnothing 12 mm | 2004965 |
| 3 | Fan R2S175 | 2004966 |
| 4 | Pump CO 1333 PXHF | 2004967 |
| 5 | Motor 17C | 2004968 |
| 6 | Temperature regulator | 2004969 |

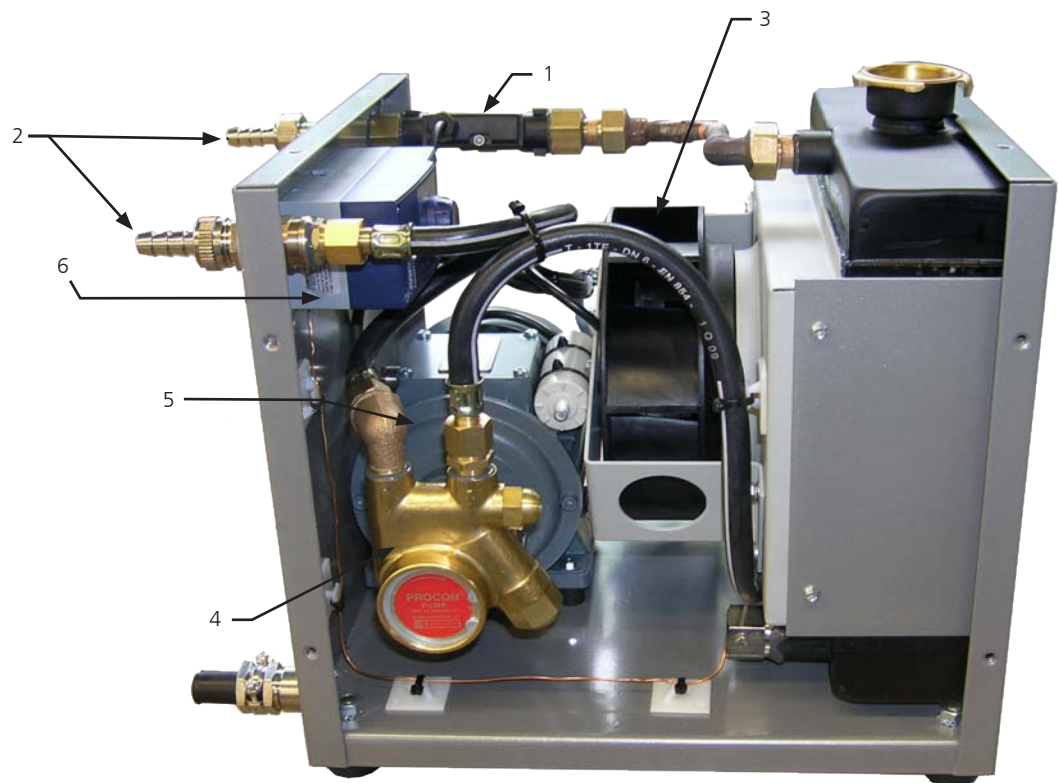

8 PERFORMANCE DIAGRAM

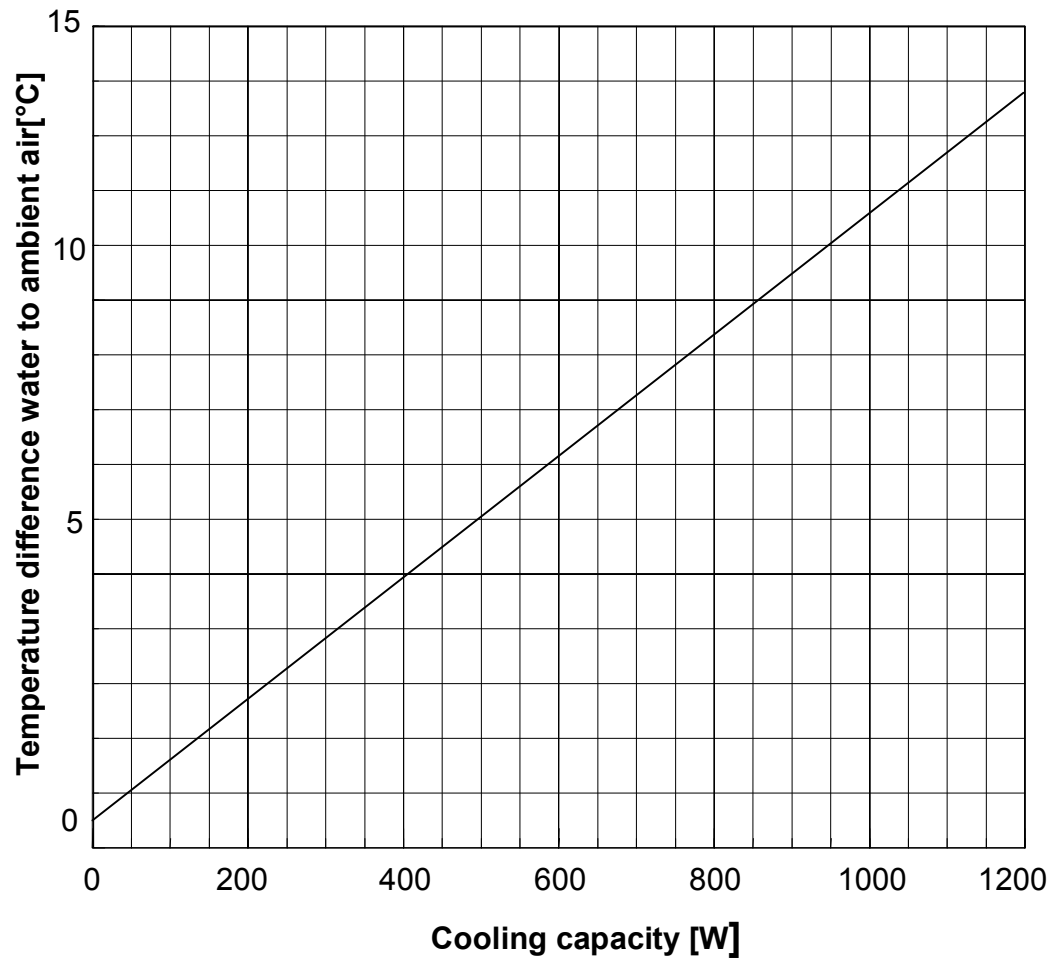

9 LIQUID AND ELECTRONIC SCHEMATIC

LIQUID CIRCUIT DIAGRAM

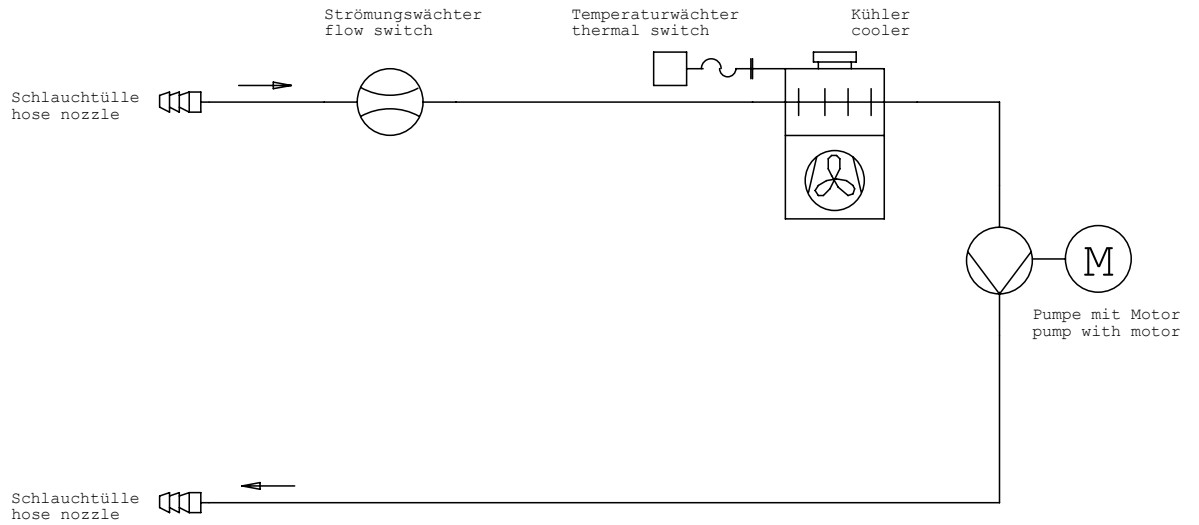

ELECTRONIC SCHEMATIC

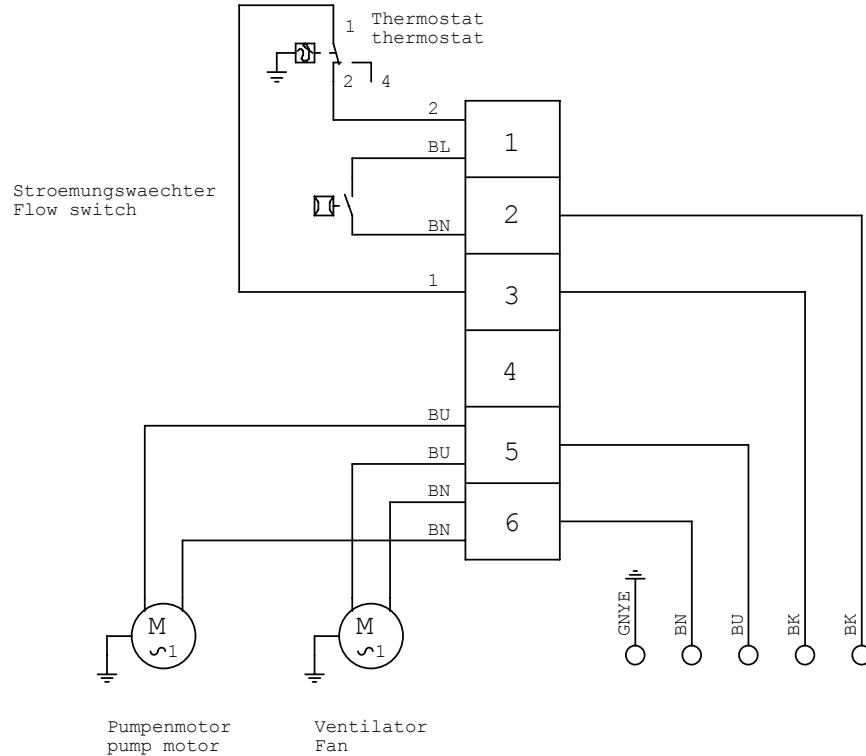

THR-UM-WL-1000 1011

Any information furnished by Laird Technologies, Inc. and its agents is believed to be accurate and reliable. All specifications are subject to change without notice. Responsibility for the use and application of Laird Technologies materials rests with the end user. Laird Technologies makes no warranties as to the fitness, merchantability, suitability or non-infringement of any Laird Technologies materials or products for any specific or general uses. Laird Technologies shall not be liable for incidental or consequential damages of any kind. All Laird Technologies products are sold pursuant to the Laird Technologies' Terms and Conditions of sale in effect from time to time, a copy of which will be furnished upon request. © Copyright 2011 Laird Technologies, Inc. All Rights Reserved. Laird, Laird Technologies, the Laird Technologies Logo, and other marks are trade marks or registered trade marks of Laird Technologies, Inc. or an affiliate company thereof. Other product or service names may be the property of third parties. Nothing herein provides a license under any Laird Technologies or any third party intellectual property rights.