

**SERIES:** VSKM-S5 | **DESCRIPTION:** MEDICAL AC-DC POWER SUPPLY

**FEATURES**

- up to 5.5 W continuous output
- compact board mount design
- universal input (85~264 Vac/110~370 Vdc)
- single regulated output from 3.3~24 V
- over voltage, over temperature, and short circuit protections
- full medical approvals
- efficiency up to 78%



MODEL	output voltage	output current max	output power max	ripple and noise typ	efficiency max
	(Vdc)	(mA)	(W)	(mVp-p)	(%)
VSKM-S5-3R3U	3.3	1250	4.125	30	66
VSKM-S5-5U	5	1000	5	30	72
VSKM-S5-9U	9	550	5	30	74
VSKM-S5-12U	12	420	5	30	76
VSKM-S5-15U	15	333	5	30	76
VSKM-S5-24U	24	230	5.5	30	78

**PART NUMBER KEY**

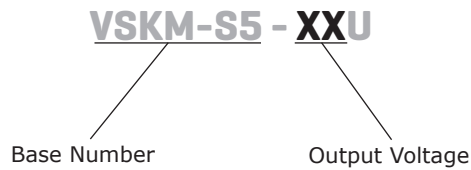

**INPUT**

parameter	conditions/description	min	typ	max	units
voltage		85		264	Vac
		110		370	Vdc
frequency		47		63	Hz
current	at 110 Vac		110		mA
	at 230 Vac		70		mA
inrush current	at 110 Vac		10		A
	at 230 Vac		20		A
input fuse	recommended external 1 A/250 V, slow-blow type				
temperature coefficient			0.02		%/°C

**OUTPUT**

parameter	conditions/description	min	typ	max	units
line regulation			±0.5		%
load regulation	at 10~100% load		±1		%
voltage set accuracy	3.3 V model		±3		%
	all other models		±2		%
hold-up time	at 230 Vac		50		ms
switching frequency			100		kHz
leakage current				0.3	mA

**PROTECTIONS**

parameter	conditions/description	min	typ	max	units
over voltage protection	diode clamp				
short circuit protection	shutdown and auto restart				
over temperature protection				150	°C

**SAFETY & COMPLIANCE**

parameter	conditions/description	min	typ	max	units
isolation voltage	for 1 minute	4,000			Vac
safety approvals	UL60601				
safety class	Class II				
conducted emissions	CISPR11/EN55011 Class A, Class B (external circuit required, see figure 2)				
radiated emissions	CISPR11/EN55011 Class A, Class B (external circuit required, see figure 2)				
ESD	IEC/EN61000-4-2 Class B, contact ±6 kV / air ±8 kV				
radiated immunity	IEC/EN61000-4-3 Class A, 10V/m				
EFT/burst	IEC/EN61000-4-4 Class B, ±2 kV				
	IEC/EN61000-4-4 Class B, ±4 kV (external circuit required, see figure 2)				
surge	IEC/EN61000-4-5 Class B, ±1 kV / ±2 kV				
	IEC/EN61000-4-5 Class B, ±2 kV / ±4 kV (external circuit required, see figure 2)				
conducted immunity	IEC/EN61000-4-6 Class A, 10 Vr.m.s				
PFM	IEC/EN61000-4-8 Class A, 10 A/m				
voltage dips & interruptions	IEC/EN61000-4-11 Class B, 0%-70%				
MTBF	at 25°C, max. load	300,000			hours
RoHS	2011/65/EU				

## ENVIRONMENTAL

parameter	conditions/description	min	typ	max	units
operating temperature	see derating curves	-25		70	°C
storage temperature		-40		105	°C
case temperature				95	°C
humidity	non-condensing			95	%

## DERATING CURVES

load vs. ambient temperature

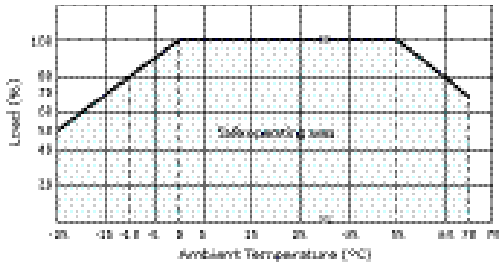

load vs. input voltage (Vac)

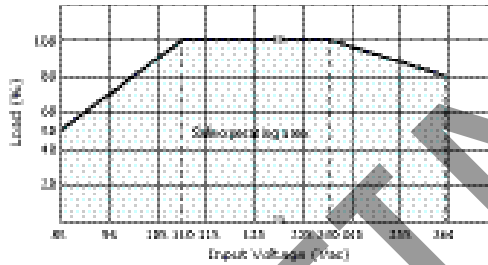

load vs. input voltage (Vdc)

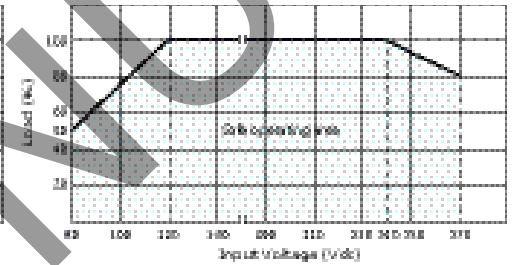

## EFFICIENCY CURVES

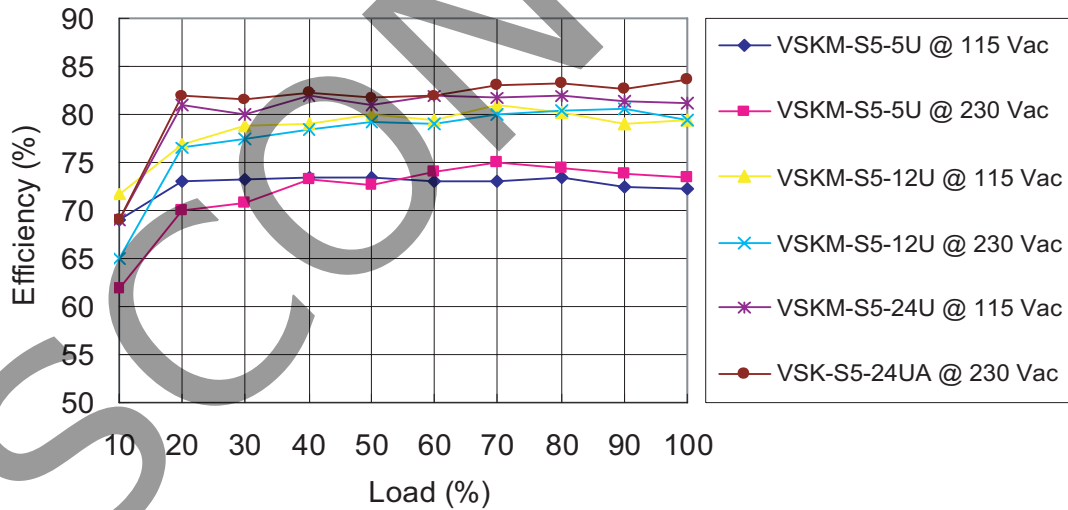

## MECHANICAL

parameter	conditions/description	min	typ	max	units
dimensions	50.8 x 25.4 x 15.16 (2.00 x 1.00 x 0.597 inch)				mm
material	UL94V-0				
weight			35		g

## MECHANICAL DRAWING

units: mm [inch]  
 tolerance:  $\pm 0.50$  [ $\pm 0.020$ ]  
 pin section tolerance:  $\pm 0.10$  [ $\pm 0.004$ ]

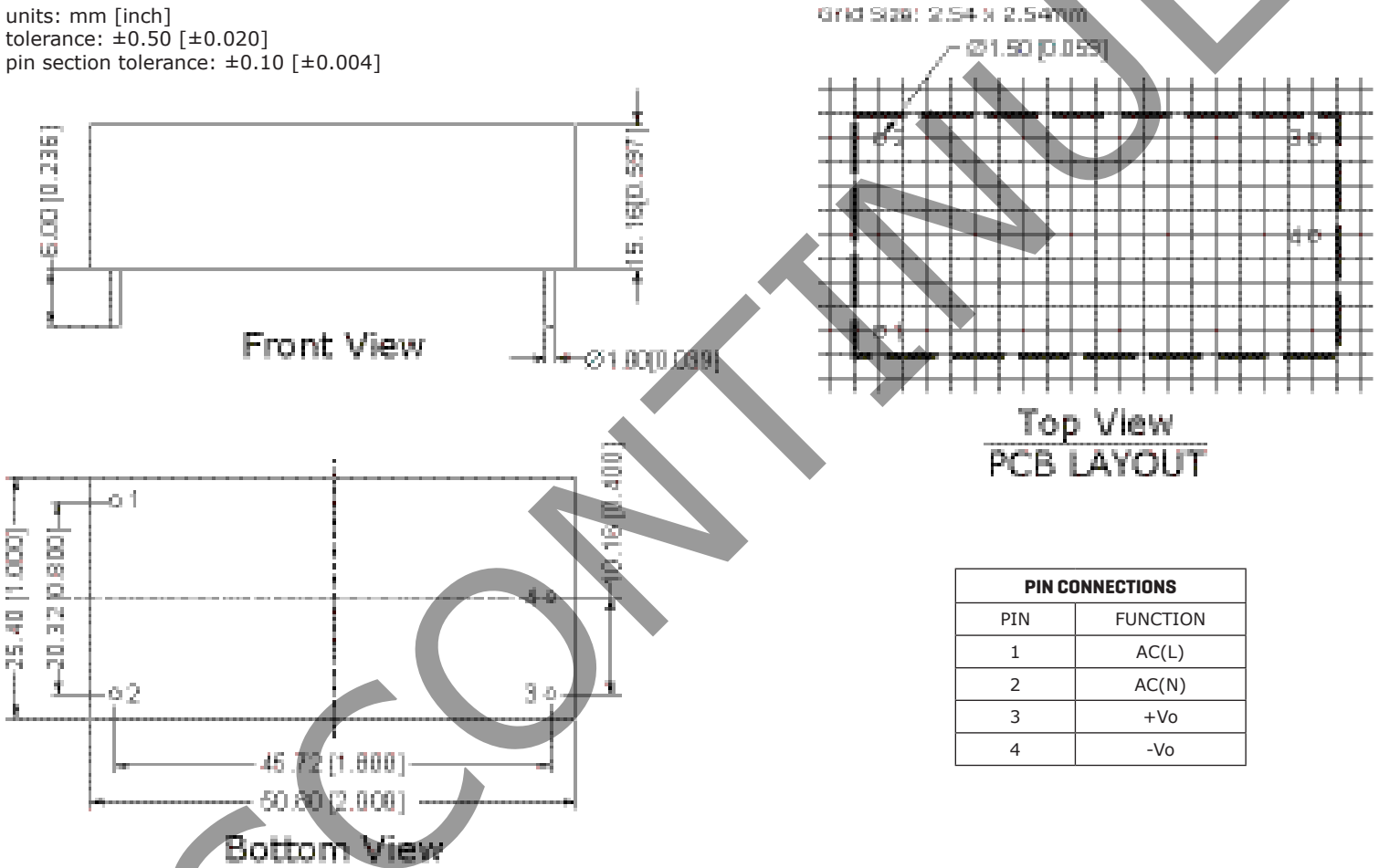

PIN CONNECTIONS	
PIN	FUNCTION
1	AC(L)
2	AC(N)
3	+Vo
4	-Vo

## TYPICAL APPLICATION CIRCUIT

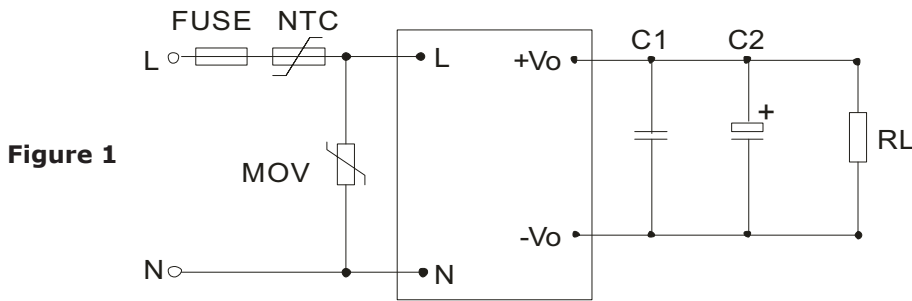

Figure 1

Table 1

Recommended External Circuit Components				
MODEL	C1 <sup>1</sup> (μF)	C2 <sup>1</sup> (μF)	FUSE	NTC
VSKM-S5-3R3U	1	47	1 A/250 V	5D-9
VSKM-S5-5U	1	47	1 A/250 V	5D-9
VSKM-S5-9U	1	33	1 A/250 V	5D-9
VSKM-S5-12U	1	33	1 A/250 V	5D-9
VSKM-S5-15U	1	33	1 A/250 V	5D-9
VSK-S5-24UA	1	10	1 A/250 V	5D-9

Note: 1. Output filtering capacitor C1 is a ceramic capacitor that is used to filter high frequency noise. C2 is an electrolytic capacitor. It is recommended to use high frequency and low impedance electrolytic capacitors. For capacitance and current of capacitor please refer to the manufacturer's datasheet. Voltage derating of capacitor should be 80% or above.

## EMC RECOMMENDED CIRCUIT

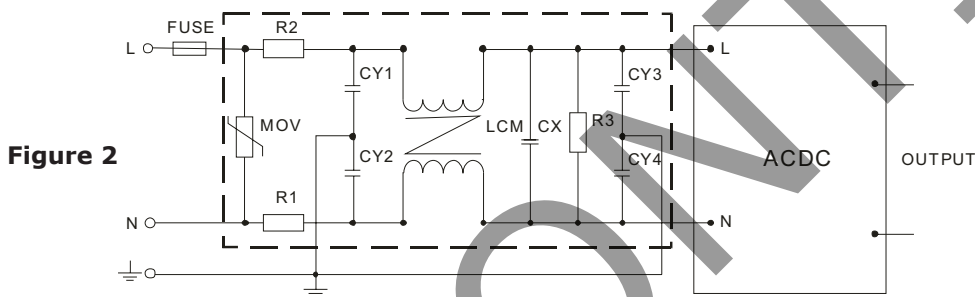

Figure 2

Table 2

Recommended External Circuit Components	
FUSE	1 A/250 V
MOV	561KD14
R1, R2	2Ω/3W winding resistor
R3	1MΩ/2W
CY1, CY2, CY3, CY4	1000pF/400Vac
CX	0.22μF/275Vac
LCM	10mH-30mH
CY	Y capacitor, 102K/400V

## TEST CONFIGURATION

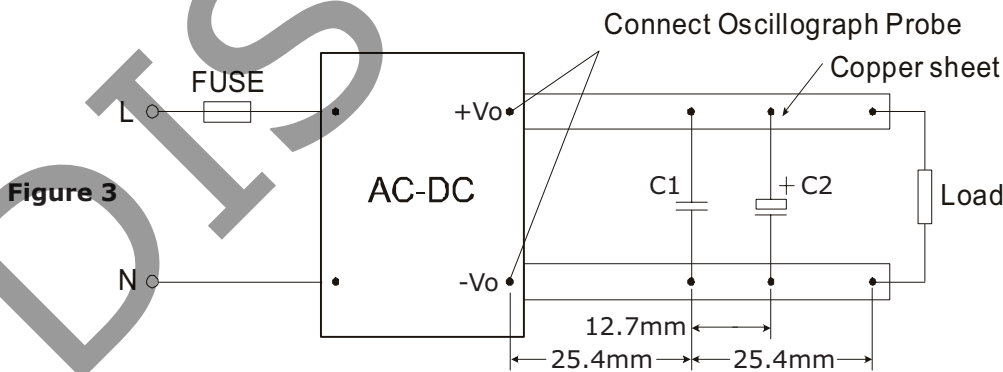

Figure 3

Table 3

Capacitors	
C1	1μF ceramic capacitor
C2	10μF electrolytic capacitor

Note: 1. All specifications measured at Ta=25°C, humidity <75%, 220 Vac input voltage, and rated output load, unless otherwise specified.

## REVISION HISTORY

rev.	description	date
1.0	initial release	01/16/2012
1.01	added leakage current to Safety & Compliance	06/20/2012
1.02	picture updated	09/06/2012
1.03	updated input data	11/13/2012
1.04	updated spec	01/08/2014

The revision history provided is for informational purposes only and is believed to be accurate.



**Headquarters**  
20050 SW 112th Ave.  
Tualatin, OR 97062  
**800.275.4899**

Fax 503.612.2383  
**cui.com**  
techsupport@cui.com

CUI offers a two (2) year limited warranty. Complete warranty information is listed on our website.

CUI reserves the right to make changes to the product at any time without notice. Information provided by CUI is believed to be accurate and reliable. However, no responsibility is assumed by CUI for its use, nor for any infringements of patents or other rights of third parties which may result from its use.

CUI products are not authorized or warranted for use as critical components in equipment that requires an extremely high level of reliability. A critical component is any component of a life support device or system whose failure to perform can be reasonably expected to cause the failure of the life support device or system, or to affect its safety or effectiveness.