

▲ CIRCUIT: SPST

NOTES:

1. ALL DIMENSIONS IN MM
2. GENERAL TOLERANCE: X.X=±0.4
X.XX=±0.25
3. TERM. NOS. FOR REFERENCE ONLY.
4. RATING: 12VDC, 50mA
5. OPERATING FORCE: 260 ± 50 gms
6. TRAVEL: 0.25mm ±0.1
7. CONTACT RESISTANCE: 100 MILLI OHMS MAX. (INITIAL)
8. MECHANICAL/ELECTRICAL LIFE 100,000 CYCLES MIN.
9. SILVER CONTACTS
10. ▲ DENOTES CRITICAL PARAMETER
11. 2002/95/EC (ROHS) COMPLIANT.
12. PACKAGING: TAPE AND REEL, 300 PIECES PER REEL

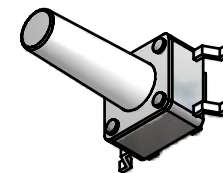
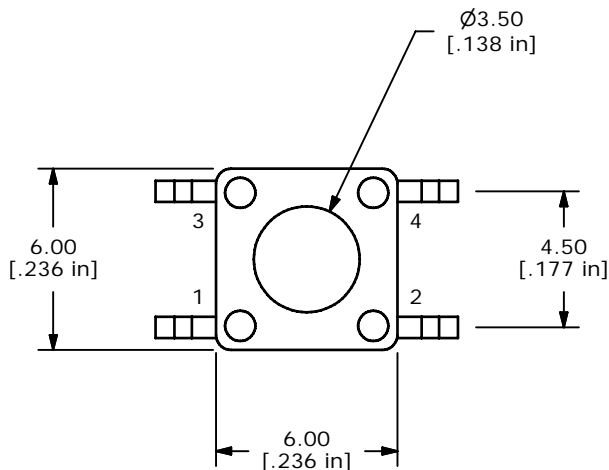

▲ ALL TERMINALS MUST BE COPLANAR WITHIN 0.10MM TOTAL

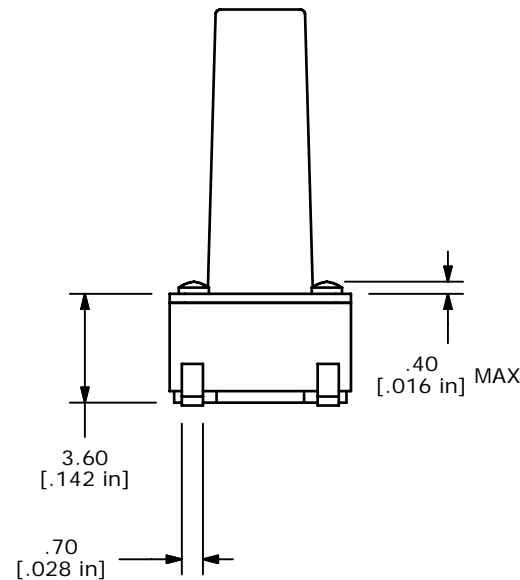
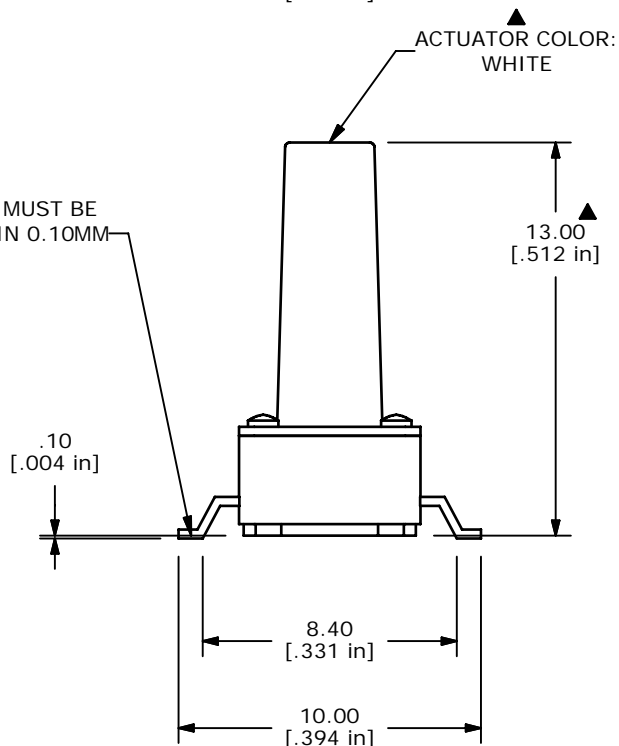

TITLE TL3301DF260QG

A	20795	NEW RELEASE	10/1/12	rc
REV	PCR NO	DESCRIPTION	DATE	BY

SCALE	DATE	DR	DWG	REV
	10/1/2012	rc	J100614	A

THE INFORMATION CONTAINED IN THIS DOCUMENT IS PROPRIETARY TO E-SWITCH AND IS NOT TO BE COPIED OR TRANSFERRED