

Digital Force Gauge

Models 475040 and 475044

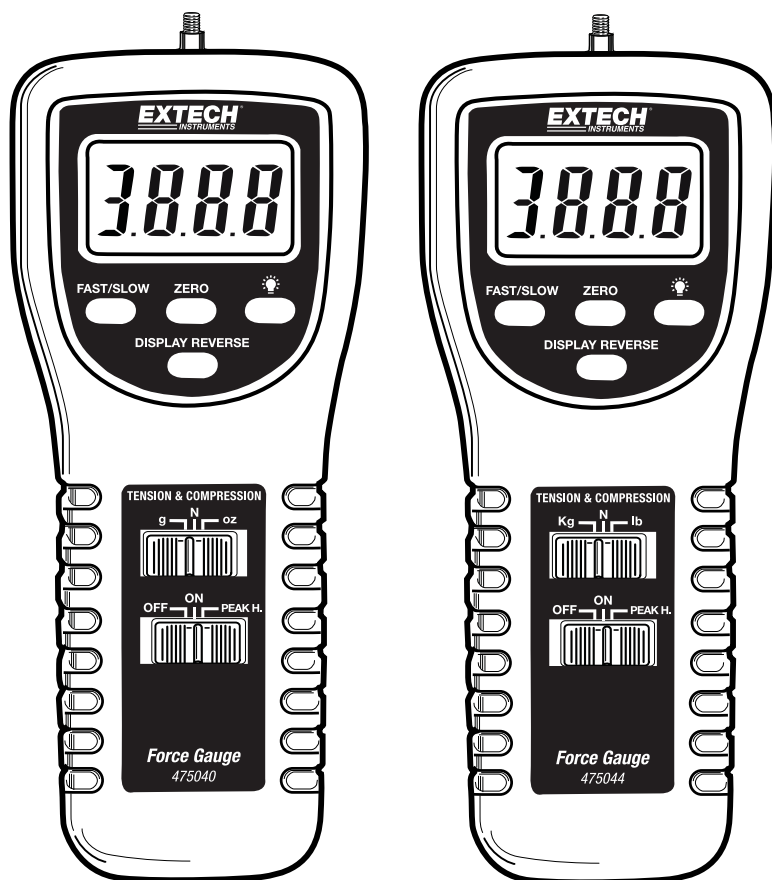

Introduction

Thank you for selecting the Extech Digital Force Gauge. This professional meter, with proper care, will provide years of safe reliable service. This device measures Tension or Compression (Push or Pull) to 5kg (475040) or 20kg (475044). The reversible display indicates readings in grams, ounces, or Newtons. This meter offers Peak Hold and a Zero function. Please visit the Extech Instruments website (www.extech.com) to check for the latest version of this User Guide.

Meter Description

FRONT DESCRIPTION

1. Universal sensing head
2. LCD Display
3. Fast response indicator
4. Unit select switch
5. OFF/ON/PEAK HOLD button
6. Battery compartment cover (on rear)

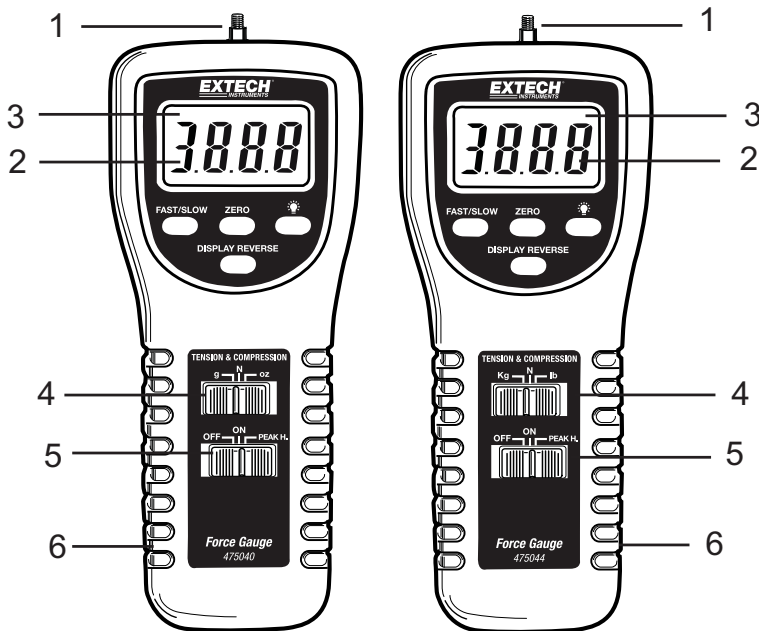

METER BACK AND MOUNTING SCREW DESCRIPTION

1. Mounting screws:

Hex head (#4 Allen wrench) with a thread size of metric (ISO) M5 x 0.8. The spacing between screws is 60.0 mm (2.36")

2. Battery compartment access screws

3. Battery compartment

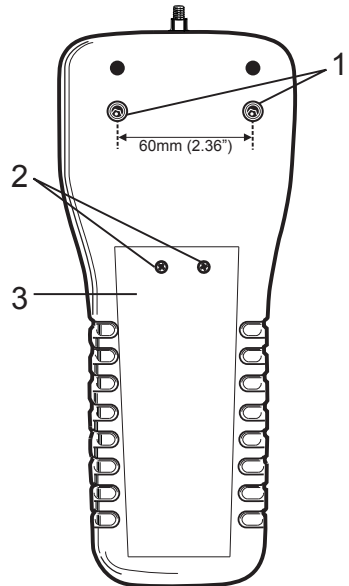

Operation

Preparation for Measurement

1. The 475044 or 474040 automatically determine TENSION or COMPRESSION (Push or Pull) force during use. Compression displays as a negative value and Tension displays as a positive value.
2. Select units of measure (grams/kilograms, ounces/pounds, or Newtons) via the units select button.
3. Attach the desired adapter (tension – hook; compression.- flat, cone or chisel head) to the Universal Sensing Head.
4. Select FAST or SLOW response. The FAST setting permits the capture of fast measurement changes and the SLOW setting provides an averaged reading display.
5. Zero the display before each measurement via the Zero button.

Note: The sensing head with adapter must be in line with the object being measured. Avoid rotating the sensing head. Refer to the figure below.

Figure 1 – Correct and Incorrect Angles of Measurement



Normal Measurement Mode

1. Slide the POWER switch to the ON position.
2. Zero the meter before each measurement.
3. Touch the adapter to the object being measured in a straight line. Refer to Fig.1.
4. Begin measurement by applying force (Push or Pull). Read the LCD display.
5. After completing the measurement, the display will indicate "0.00" if the position and angle of the Force Gauge have not changed.
6. If the position or angle of the Force Gauge changes during a measurement, the display may show one of the following:
 - a) The display over-ranges because the initial force of the transducer **decreases** due to a change in the position or angle of the Gauge after measurement.
 - b) The display indicates any value such as "12", "25", etc. This occurs because the initial force of the transducer **increases** due to a change in the position or angle of the Gauge after measurement.

Note: Be sure to press "ZERO" before taking any new measurements.

Mounting

For best results, mount the Digital Force Gauge to a test stand. Mounting holes are provided on the rear of the meter.

Maintenance

Battery Replacement

The low battery indication appears as a "LO" on the display when battery voltage is less than 6.8V. To replace the battery:

1. Remove the two screws from the battery compartment cover.
2. Lift off the battery cover.
3. Replace with 6x 1.5V AA (UM-3) batteries. Observe polarity carefully.
4. Replace compartment cover and screws.



All EU users are legally bound by the Battery Ordinance to return all used batteries to community collection points or wherever batteries / accumulators are sold! Disposal in household trash or refuse is prohibited!

Disposal: Follow the valid legal stipulations in respect of the disposal of the device at the end of its lifecycle

Specifications

	475044	475040
Range	44 lbs, 20kg, 196 Newtons	176oz, 5000g, 49 Newtons
Accuracy (23°C)	±(0.5%rdg + 2 digits)	± (0.4%rdg + 1 digit)
Resolution	0.01lbs, 0.01kg, 0.05 Newtons	0.05oz, 1g, 0.01 Newtons
Overload Capacity	30kg	10kg
Circuit	Custom LSI microprocessor circuit	
Zero adjust	Button for Peak Hold and normal display zero	
Display	5 digits, 16 mm (0.63") LCD display	
Update Rate	Fast mode 0.2 secs; Slow mode 0.6 secs.	
Over-range Indicator	Displays "-----"	
Zero Control	Maximum capacity	
Full Scale Deflection:5000g	Approx. 2mm max.	
Full Scale Deflection:20kg	Approx. 0.4mm max.	
Transducer type	Load cell	
Peak Hold	Freezes Max reading on display	
Operating Temperature	0 °C to 50 °C (32 °F to 122 °F).	
Operating RH	Max. 80% RH.	
Power Supply	6x 1.5V AA (UM-3) size battery or DC 9V adapter (not included)	
Weight	480g / 1.1 lbs.	
Size	215 x 90 x 45 mm (8.5 x 3.5 x 1.8")	
Mounting Holes	Located on rear of gauge	
Accessories	Tension adapter (hook), compression adapters (flat, cone, and chisel), 5" extension rod, 6 x 1.5V AA batteries, case	

Copyright © 2014 FLIR Systems, Inc.

All rights reserved including the right of reproduction in whole or in part in any form

www.extech.com