

MCR-T-UI(/NC) MCR-T-UI-E(/NC)

Programmable Temperature Transducers for Resistance Thermometers and Thermocouples

INTERFACE

Data Sheet
100242_03_en

© PHOENIX CONTACT - 06/2007



Description

A universal temperature measuring transducer for resistance thermometers and thermocouples, with freely selectable temperature range, is available for the **MCR-T-UI** converters:

- Resistance thermometer: -200...+850°C
- Thermocouples: -200...+2300°C

At the output side, the following analog standard signals can be used with normal (e. g. 0...10 V) and inverse (e. g. 10...0 V) action:

- 0...20 mA
- 4...20 mA
- 0...10 V
- ±10 V
- 0...5 V
- 1...5 V
- ±5 V

A PNP transistor switching output (100 mA) with two switching points and eight switching functions provides an additional monitoring function.

Versions

- Standard configuration: **MCR-T-UI(-E)-NC**
(Pt 100 according to DIN IEC 60751, with 3-wire technology of -200...+850°C with 4...20 mA output and blocked switching output)
- Configuration on basis of order: **MCR-T-UI(-E)**
Specify the configuration in the order key (see page 2). Upon delivery the module is configured according to user requirements and therefore ready to operate.

The modules can be parameterized freely using the configuration software MCR/PI-CONF-WIN.



Make sure you always use the latest documentation.
It can be downloaded from www.download.phoenixcontact.com.

A conversion table is available on the internet at
www.download.phoenixcontact.com/general/7000_en_00.pdf.



This data sheet is valid for the following products:

Ordering Data

Temperature Measuring Transducers

Description	Type	Order No.	Pcs./Pck.
Programmable temperature transducers for thermocouples and resistance thermometers with 2, 3, or 4-wire technology, not configured	MCR-T-UI/NC	2814100	1
Programmable temperature transducers for thermocouples and resistance thermometers with 2, 3, or 4-wire technology, configured	MCR-T-UI... ¹	2814090	1
Programmable temperature transducers for thermocouples and resistance thermometers with 2, 3, or 4-wire technology, with electrical isolation between input/output and input/auxiliary power, not configured	MCR-T-UI-E/NC	2814126	1
Programmable temperature transducers for thermocouples and resistance thermometers with 2, 3, or 4-wire technology, with electrical isolation between input/output and input/auxiliary power, configured	MCR-T-UI-E... ¹	2814113	1

¹ See "Order key for MCR-T-UI and MCR-T-UI-E"

Accessories

Description	Type	Order No.	Pcs./Pck.
PI/MCR configuration software, for programming the PI/Ex-RTD..., PI/Ex-THC..., MCR-T..., MCR-PSP..., MCR-f... and MCR-s... modules	MCR/PI-CONF-WIN	2814799	1
Software adapter cable (stereo jack connector/D-SUB 25-pos.), 1.2 m, for programming MCR-T-UI... modules	MCR-TTL-RS232-E	2814388	1

Order Key for MCR-T-UI and MCR-T-UI-E

The standard configuration will be supplied if customer order details are incorrect or not provided.

	Type of sensor	Characteristic curve	Connection technology	Measuring range	
Standard configuration:					
2814090	PT100	D	3	-200,0	+850,0
2814090 ≙ MCR-T-UI 2814100 ≙ MCR-T-UI-NC 2814113 ≙ MCR-T-UI-E 2814126 ≙ MCR-T-UI-E-NC	see tables on page 3 under "Type of sensor" or "Order reference"	D ≙ DIN S ≙ SAMA 0 ≙ for thermocouple, resistor, potentiometer, voltage, Ni 1000 (Landis & Gyr), Cu 10, KTY 81-110, Cu 50, Cu 53	2 ≙ 2-wire 3 ≙ 3-wire 4 ≙ 3-wire 0 ≙ for thermocouple, resistor, potentiometer, voltage	Initial value at 0 mA (e. g. -200.0°C)	End value at 20 mA (e. g. +850.0°C)
	Unit of measurement	Output	Output characteristic curve	Factory calibration certificate	
	C	OUT02	N	NONE	
	C ≙ °C F ≙ °F V ≙ mV O ≙ Ω P ≙ %	OUT01 ≙ 0...20 mA OUT02 ≙ 4...20 mA OUT03 ≙ 0...10 V OUT05 ≙ 0...5 V OUT13 ≙ -5...+5 V OUT14 ≙ -10...+10 V	N ≙ normal I ≙ inverse	NONE ≙ without factory calibration certificate YES ≙ with factory calibration certificate (a fee is charged) YESPLUS ≙ with factory calibration certificate WKZ ... with 5 measuring points (a fee is charged)	

Resistance thermometer ¹			
Type of sensor ²	Measuring range	Standard	Smallest measuring range span
Pt ...	-200...+850°C	DIN/SAMA	0.4 K
Ni ...	-60...+180°C	DIN/SAMA	0.4 K
Ni 1000	-50...+160°C	Landis & Gyr	0.4 K
Cu 10	-70...+500°C	SAMA	0.4 K
Cu 50	-50...+200°C	–	0.4 K
Cu 53	-50...+180°C	–	0.4 K
KTY 81 (≅ KTY 81-110)	-55...+150°C	Philips	0.4 K
KTY 84 (≅ KTY 84-130)	-40...+300°C	–	–

¹ Temperature ranges in accordance with IEC 60751/EN 60751 or DIN 43760 and SAMA RC 21-4-1966 in 2, 3 or 4-wire technology

² Other types and characteristic curves on request.

Resistors, potentiometers, mV-voltages			
Input	Measuring range	Order reference	Smallest measuring range span
Resistor	0...8 kΩ (2-wire technology)	RES	2 Ω
Potentiometer (max. 8 kΩ)	0...100% (3-wire technology)	POT	0.2%
Voltage	-20 mV ... +2400 mV	VOL	2 mV

Thermocouples ¹			
Type of sensor ²	Material	Measuring range	Smallest measuring range span
U ¹	Cu-CuNi	-200...+600°C	> 1 K
T ¹	Cu-CuNi	-200...+400°C	> 1 K
L ¹	Fe-CuNi	-200...+900°C	> 1 K
J ¹	Fe-CuNi	-210...+1200°C	> 1 K
E ¹	NiCr-CuNi	-226...+1000°C	> 1 K
K ¹	NiCr-Ni	-200...+1372°C	> 1 K
N ¹	NiCrSi-NiSi	-200...+1300°C	> 1 K
S ¹	Pt10Rh-Pt	-50...+1768°C	> 4 K
R ¹	Pt13Rh-Pt	-50...+1768°C	> 4 K
B ¹	Pt30Rh-Pt6Rh	500...+1820°C	> 10 K
C	–	-18...+2316°C	> 4 K
W	–	-18...+2316°C	> 4 K
HK	–	-200...+800°C	> 1 K

¹ Thermocouples in acc. with IEC 60584/EN 60584

² Other types and characteristic curves on request.

Order Examples for MCR-T-UI(-E) With Different Input Versions

Resistance thermometer

2814113 / PT100 / D / 3 / -200,0 / +850,0 / C / OUT02 / N / NONE

Configuration for 3-wire Pt 100 sensor -200.0...+850.0°C with output characteristic curve 4...20 mA, without factory calibration certificate

Thermocouple

2814113 / J / 0 / 0 / -346 / +2192 / F / OUT02 / N / NONE

Configuration for type J thermocouple of -346...+2192°F with 4...20 mA output characteristic curve, without factory calibration certificate

Voltage

2814113 / VOL / 0 / 0 / -10 / 1200 / V / OUT03 / I / YES

Configuration for voltage input of -10...+1200 mV with 10...0 V output characteristic curve, with factory calibration certificate

Resistor (2-wire technology)

2814113 / RES / 0 / 0 / 0 / 7500 / O / OUT05 / N / NONE

Configuration for connecting a resistor, which varies between 0 Ω and 7.5 kΩ, with 0...5 V output signal, without factory calibration certificate

Potentiometer (3-wire technology)

2814113 / POT / 0 / 0 / 10 / 90 / P / OUT02 / N / NONE

Configuration for connecting a 3-wire potentiometer, where 10% ... 90% of the range is used, with 4...20 mA output signal, without factory calibration certificate

Technical Data

Input

Resistance thermometer	in 2, 3 and 4-wire technology in accordance with IEC 60751/EN 60751 or DIN 43760 and SAMA RC 21-4-1966
Thermocouples	B, E, J, K, N, R, S, T, L, U, C, W, HK in acc. with IEC 60584/EN 60584
Resistors	≤ 8 kΩ
Potentiometers	≤ 8 kΩ
Linear mV signals	-20 mV... +2400 mV
Supply current (resistance thermometer)	250 μA
Input protection	Transient protection, surge protection 30 V DC

Output

	U_{OUT}	I_{OUT}
Output signal	0 V ... 5 V / 0 V ... 10 V ±5 V / ±10 V	0 mA ... 20 mA 4 mA ... 20 mA
Max. output signal	±12 V	24 mA
Load	≥ 10 kΩ	≤ 500 Ω
Ripple	≤ 20 mV _{pp}	≤ 20 mV _{pp}
Output signal on open circuit (adjustable)	-12 V ... +12 V	0 mA ... 24 mA
Overrange/underrange (adjustable)	-12 V ... +12 V	0 mA ... 24 mA
Resolution	3 mV	6 μA
Output protection	Transient protection	Transient protection

Switching Output

Output description	Transistor output, PNP
Load capability	100 mA



The switching output switches the supply voltage and is not short-circuit-proof.

General Data

Supply voltage	18 V DC ... 30 V DC
Current consumption at 24 V DC	
Maximum	< 60 mA
Typical	40 mA
Transmission error	
of end value	< 0,1%
at the output	±6 mV/12 μA
Cold junction error	
Maximum	≤ 3 K
Typical	1.5 K
Temperature coefficient	
Maximum	0.01%/K
Typical	0.005%/K
Test voltage	
Input/output	1 kV, 50 Hz, 1 minute
Input/supply	1 kV, 50 Hz, 1 minute
Ambient temperature range	-20 °C ... +65 °C
Dimensions (W x H x D)	17.5 mm x 99 mm x 114.5 mm
Conductor cross section	0.2 mm ² ... 2.5 mm ²
Stripping length	8 mm
Housing version	Polyamide PA not reinforced, color green

Approvals

CE



GL



UL/CUL Recognized

MCR-T-UI/NC

MCR-T-UI...

MCR-T-UI-E/NC

MCR-T-UI-E...



UL/CUL Listed

MCR-T-UI-E/NC

MCR-T-UI-E...

**PROCESS CONTROL EQUIPMENT FOR HAZARDOUS LOCATIONS LISTED 312N****Class I Div 2 Groups A, B, C, D**

A) This equipment is suitable for use in Class I, Division 2, Groups A, B, C and D or non-hazardous locations only.

B) Warning - explosion hazard - substitution of components may impair suitability for Class 1, Division 2.

C) Warning - explosion hazard - do not disconnect equipment unless power has been switched off or the area is known to be non-hazardous.

Conformance With EMC Directive 89/336/EEC and Low Voltage Directive 73/23/EEC**Noise Immunity Test According to EN 61000-6-2**

Discharge of static electricity (ESD)	EN 61000-4-2	Criterion B	8 kV
Air discharge			6 kV
Contact discharge			
Electromagnetic HF field	EN 61000-4-3	Criterion A	
Amplitude modulation 10 V/m			10 V/m
Pulse modulation			10 V/m
Fast transients (burst)	EN 61000-4-4	Criterion B	
Input/output/supply			2 kV/5 Hz
Surge current load (surge)	EN 61000-4-5	Criterion B	
Input/output			1 kV/2 kV/42 Ω
Supply			0.5 kV/2 Ω
Conducted interference	EN 61000-4-6	Criterion A	10 V
Input/output/supply			

Noise Emission Test According to EN 61000-6-4

Noise emission, housing	EN 55011	Class A	
-------------------------	----------	---------	--

Structure

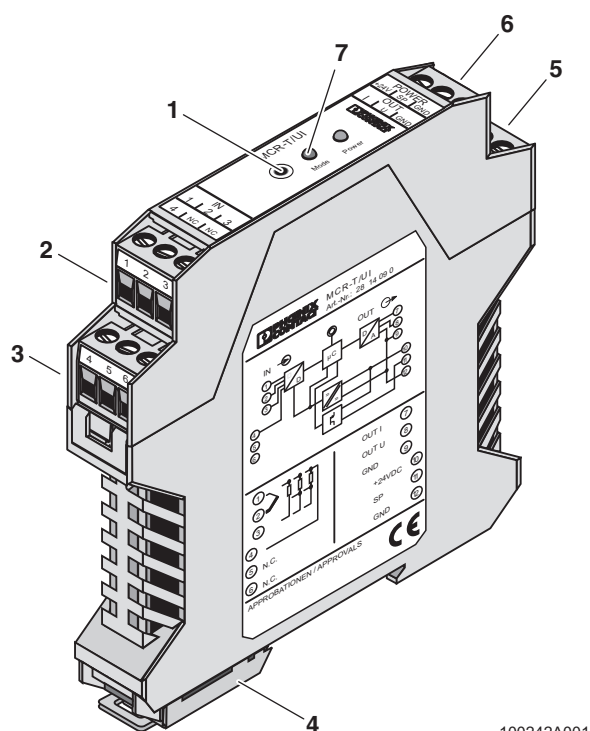

Figure 1 Structure

- 1 Programming interface
- 2 Input (plug-in screw terminal)
- 3 Shield connection (on terminal ⑤ or ⑥)
- 4 Metal latch for fixing to the DIN rail
- 5 Supply voltage and switching output (plug-in screw terminal)
- 6 Analog output (plug-in screw terminal)
- 7 Error LED

Input

The following sensor types and input signals can be processed on the input side:

- Resistance thermometer with 2, 3 or 4-wire technology
- Thermocouples
- Thermocouples of the same type connected in series for measuring temperature differentials
- mV voltages of -20...+2400 mV
- Linear resistors in the range from 0...8 k Ω
- Potentiometers up to 8 k Ω

Output

The MCR-T-UI... has two outputs:

- Analog output with either 0(4)...20 mA or 0...10 V, ± 10 V, 0(1)...5 V, ± 5 V with normal (e. g. 0...10 V) and inverse (e. g. 10...0 V) action. The loads must not fall below a voltage output of 10 k Ω and must not exceed a current output of 500 Ω .
- PNP transistor switching output (100 mA) without free-wheeling diode but with suppressor diode for transient protection. You will need the MCR/PI-CONF-WIN configuration software to program this output.

Block Diagrams

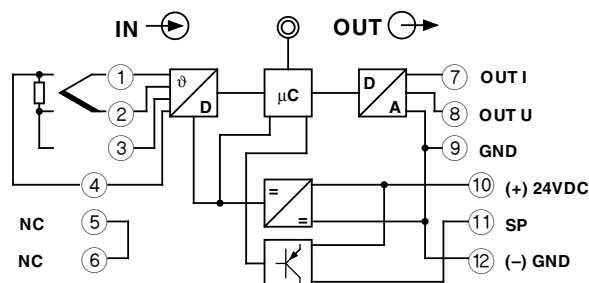

Figure 2 MCR-T-UI(-NC)

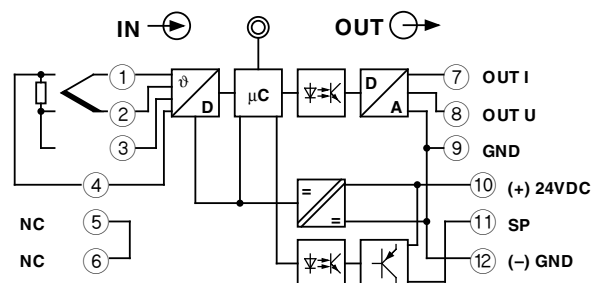

Figure 3 MCR-T-UI-E(-NC)

Method of Operation

The analog input signal of the temperature sensor is digitized with a 24-bit resolution and then supplied to a microcontroller. The microcontroller forms a digital output value in line with the temperature from the input signal. This is supplied via optocouplers to a D/A converter after electrical isolation. The corresponding output signals are realized using a subsequent voltage or current level (e. g. 0...10 V, 0...20 mA).

The microcontroller has an integrated memory in which the program sequence for the measured value calculation is stored. The user-specific parameters are stored in an EEPROM (electrically erasable programmable read-only memory). The programmed data remains in the memory even after the supply voltage has been disconnected.

Connections

Thermocouples

- Simple temperature measurement
For temperature measurements with the thermocouples described on page 3, wire terminals ① and ② of MCR-T-UI. Note the polarity of the sensor (① = "+" input; ② = "-" input).
- Differential temperature measurement
To measure temperature differentials with only one temperature measurement converter, the MCR-T-UI offers the option of connecting two thermocouple sensors of the same type in series and laying the two remaining branches to terminal points ① and ②. The connection ends of the two thermocouples can be fixed to terminal points ⑤ and ⑥ (see corresponding circuit diagram on page 6). The differential temperature measurement can only be set using the configuration software MCR/PI-CONF-WIN because the internal cold junction compensation must be switched off for this.

Resistance Thermometer

For temperature measurements with the resistance thermometers described on page 3, wire the following terminal points depending on the connection method used (see corresponding block diagram on page 6):

- ① and ③ with 2-wire technology
- ①, ② and ③ with 3-wire technology
- ①, ②, ③ and ④ with 4-wire technology

Measurement of mV Voltages

Voltages in the range of -20...+2400 mV are measured at terminals ① and ② where ① is the "+" input and ② the "-" input.

Measurement of Resistance

To measure differing resistance between 0 Ω and 8 k Ω , terminal points ① and ③ are used.

The connection is made using 2-wire technology.

Evaluation of Potentiometer Settings

To evaluate potentiometers up to 8 k Ω , terminals ① and ③ are connected with the external cables and terminal ② is connected with the loop cable.

Switching Output

The PNP transistor switching output switches the supply voltage U_B when the programmed switching conditions are met from 24 V on terminal ①. The transistor output should only be loaded with a maximum of 100 mA. A suppressor diode protects this output from fast transients.

Error Detection

Open Circuit / Measurement Range Upper and Lower Deviation

Indication of open circuit and measurement range upper and lower deviation with modules configured on the basis of the order:

- The red "MODE" LED is permanently on
- The following voltages and currents can be measured at the output using the selected output signal configuration:

Output signal	Output signal on	
	Open circuit	Measurement range upper and lower deviation
0...5 V; ± 5 V	5.5 V	5.25 V
0...10 V; ± 10 V	11 V	10.5 V
0...20 mA	22 mA	21 mA
4...20 mA	22 mA	21 mA

During independent configuration, values between -12...+12 V or 0...24 mA can be set freely.

Changing the Configuration Data

Use the MCR/PI-CONF-WIN configuration software to change the configuration data. A user manual and online help for the software provide a more detailed explanation of the configuration options and how to carry them out.

Use the MCR-TTL-RS232-E adapter cable to connect the module and PC. This cable is not included in the scope of supply for the configuration software (see "Ordering Data" on page 2).

Application Example

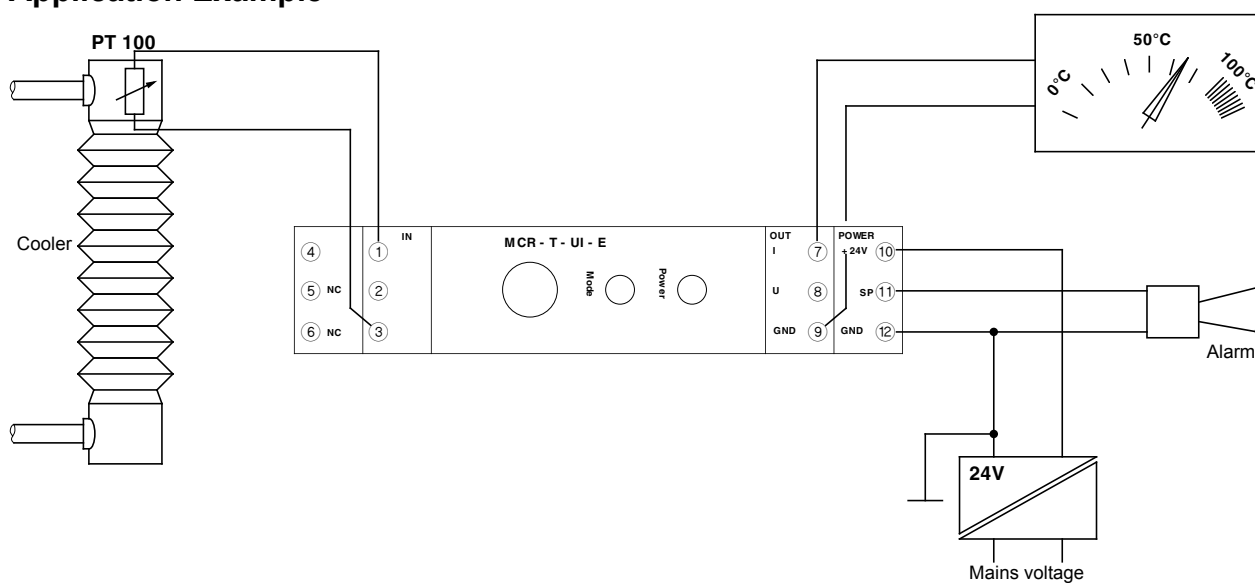

Figure 4 Temperature monitoring with a Pt 100 element with 2-wire technology using the transistor switching output

Connection Examples

Application 1

For short distances (< 10 m)



The cable resistances R_{L1} and R_{L2} directly affect the measuring result and make it incorrect (example for Pt 100: $0.385 \Omega \approx 1 \text{ K}$). Compensation of $\pm 5\%$ is possible.

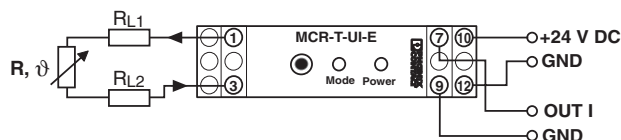

Application 2

For long distances between Pt 100 sensor and MCR-T-UI... ($R_{L1}, R_{L2}, R_{L3} \leq 25 \Omega$)



To compensate the cable resistance, all cable resistances must have exactly the same values ($R_{L1} = R_{L2} = R_{L3}$)

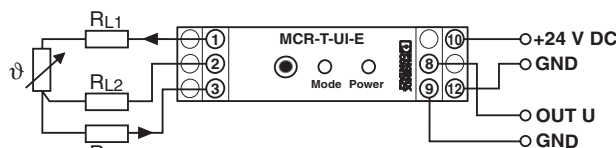

Application 3

For long distances between the Pt 100 sensor and MCR-T-UI... differing cable resistances ($R_{L1} \neq R_{L2} \neq R_{L3} \neq R_{L4}$)



The cable resistance ($R_{L2} + R_{L4}$) should not exceed 50Ω .

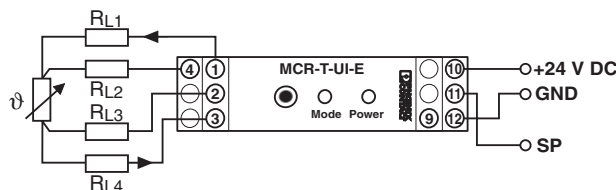

Application 4

For short distances and slow changes



Cable resistances R_{L1} and R_{L2} are incorporated in the measurement result directly and falsify the result accordingly. Compensation of $\pm 5\%$ is possible.

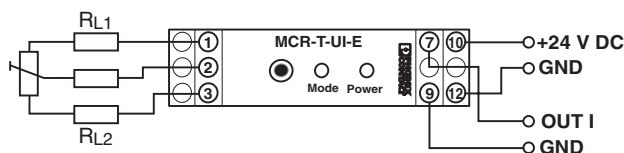

Application 5

Connecting a thermocouple or an mV signal

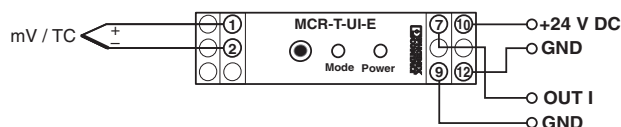

Application 6

Differential temperature measurement using thermocouples

