

Light Chaser

Beginner Soldering Kit

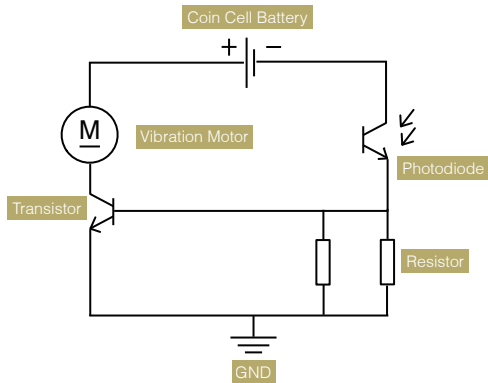

The 4-Soldering Light Chaser Kit is an introductory electronic kit designed to help kids or electronic enthusiasts, and novices learn about electronic basics like soldering and simple circuits. Mr. NEON is designed to look like a three-leg monster whose eyes or tentacles glow and dim depending on surrounding light. The stronger the light is, the faster Mr. NEON moves. There is no programming involved, and all of the soldering is beginner-friendly, making it perfect for budding electronic enthusiasts. Mr. NEON is also able to change “faces” through expression stickers.



These working principles are illustrated in the diagram below.

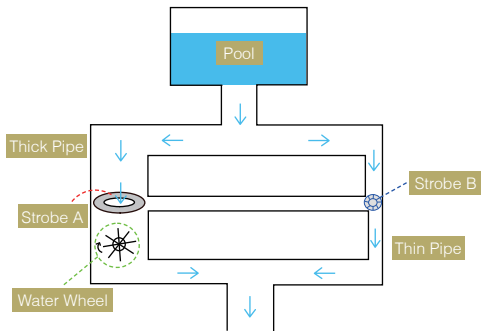

1. The water in the pool flows downward, first through the thick pipe, then the thin pipe.

2. Strobe A, located in the thick pipe, is controlled by the water flow in the thin pipe; the thin pipe is controlled by strobe B.

3. If there is no water flow in the thin pipe, then the strobe located in the thick pipe will close. The greater the water flow in the thin pipe, the wider strobe A opens up. Since strobe A controls water flow through the thick pipe, water flow will increase when strobe A opens. This is the function of the transistor.

4. The water flow in the thick pipe determines the speed of the water wheel – increased water flow will make the waterwheel spin faster. The pool represents the coin cell battery; the waterwheel represents the vibration motor; strobe B represents the photodiode. Stronger surrounding light will cause the vibration motor to run faster.

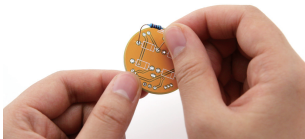

Step1

Bend the legs downward and insert them into the board.

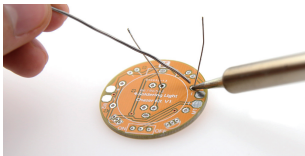

Step2

Flip the board over. Place the soldering iron's "sweet spot" (shown in diagram) and make sure it touches both the leg and the metal ring. Hold for 1 to 2 seconds.

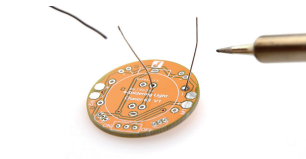

Step3

Pull the soldering wire away first, then the soldering iron.

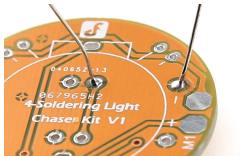

Step4

Your solder joints should look like this: a tiny volcano.

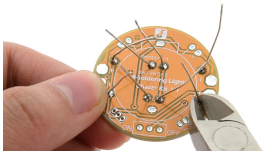

Step5

Clip off all excess wire so that only the tiny solder joints remain.

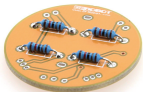

Step6

Resistance soldering completed.

WARNING: Please wear safety goggles.
This kit requires soldering and clipping leads.

Making the head

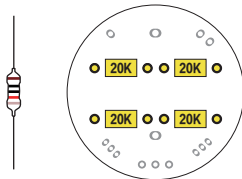

1. Solder the resistors
After soldering, cut off the remaining length of the wire.



20K Ohm Resistor

Used for limiting current or dividing voltage, a resistor is a common component within circuits. Just solder the resistors to its proper position on the board (shown in the diagram), regardless of the electrode being positive or negative.

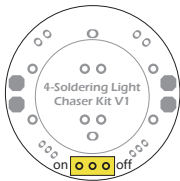

2. Solder the switch
After soldering, cut off the remaining length of the wire.



Switch

The switch is for power ON and OFF.

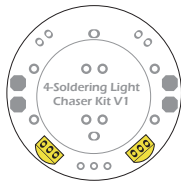
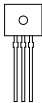

3. Solder the transistors
After soldering, cut off the remaining length of the wire.



Transistor

The transistor is a powerful component. Notice the silkscreen (white print on the board) resembles a half circle. Make sure that place the transistors in the holes on the basis of the silkscreen. The round side on the board should match the round side of the transistor.

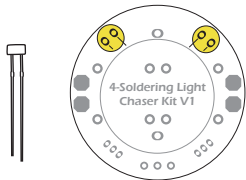

4. Solder the photodiodes
After soldering, cut off the
remaining length of the wire.



Photodiode(S8050)

The photodiode is a component that changes a light signal into a current or voltage signal. It is highly sensitive to light intensity, and can be used to change a circuit's current. Insert the photodiodes into the front of the board. Each photodiode has a short leg and a long leg. The long leg goes into the hole labeled with a long line.

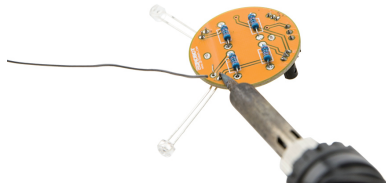

Place the photodiode into the front side of the board. Then, bend the photodiode into a 90 degree angle (see picture), making sure to leave around 25mm at the base of the diode. Flip the board over and solder the joints.

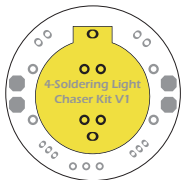

5. Solder the Battery Clip



Battery Clip

The battery clip is for holding the coin cell battery. Set the battery clip on the white footprint of the upper side of the board. Solder the two clip legs from the opposite side while keeping the part flat.

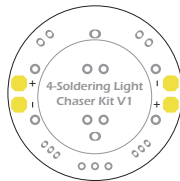
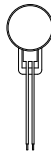

6. Solder the vibration motors
After soldering, cut off the remaining length of the wire.



Vibration Motor

The vibration motor provides the power source that enables Mr. NEON to happily hum along. Solder the motors into the front of the board. The red leg goes into the hole labeled "+".

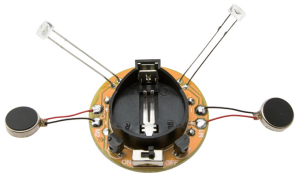

Mr. Neon should at this point look like the above picture.

Making the Base

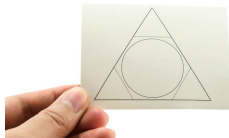
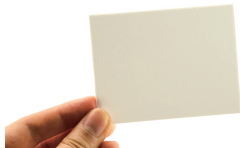

Step 1

Take out the plastic paper and the sticker with a printed triangle.

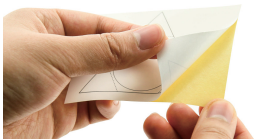

Step2

Unpeel the triangle sticker and place it atop the plastic paper.

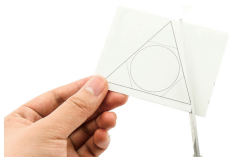
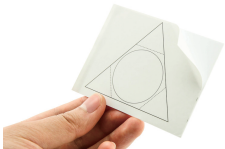

Step3

Cut the plastic paper with a scissor along the edge of the triangle.

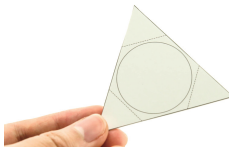



Step4

Trim the sharp corners of the triangle.

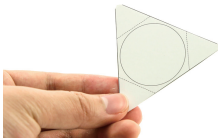

Step5

Bend three small triangles into 90 degrees along dotted lines.





Step6

Place the adhesive against the body as shown.



Step8

Stick the two vibration motors against Mr. NEON's legs.



Step7

Put the head on the body.



Step9

Place the plastic tubing over the photodiodes; this prevents electric interference with the exposed probe.

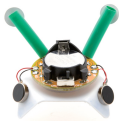

Done

You've assembled Mr. Neon! You can add stickers to Mr. Neon to give him appearance and flair that make him stand out from the rest.

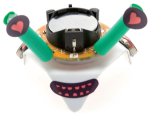

A step-by-step video walkthrough showing the assembly of Mr.

Neon is available online — to view it, please go to the DFRobot Mr. Neon product page.

Shipping List

Light Chaser PCB Board	x1
Battery	x1
Battery Clip	x1
On/Off Switch	x1
Transistor	x2
Vibration Motor	x2
Photodiode	x2
20K Ohm Resistor	x4
Plastic paper	x1
Plastic Tubing	x1
Adhesive Sticker	x1
Base Sticker	x1
Face Sticker	x1



dfrobot

dfrobot

dfrobotcn

www.DFRobot.com

Made in China

Designed by **DFROBOT**