

BLF6G38-25; BLF6G38S-25

WiMAX power LDMOS transistor

Rev. 4 — 1 September 2015

AMMPLÉON

Product data sheet

1. Product profile

1.1 General description

25 W LDMOS power transistor for base station applications at frequencies from 3400 MHz to 3800 MHz.

Table 1. Typical performance

Typical RF performance at $T_{case} = 25\text{ °C}$ in a class-AB production test circuit.

Mode of operation	f (MHz)	V_{DS} (V)	$P_{L(AV)}$ (W)	G_p (dB)	η_D (%)	ACPR _{885k} (dBc)	ACPR _{1980k} (dBc)
1-carrier N-CDMA ^[1]	3400 to 3600	28	4.5	15	24	-45 ^[2]	-61 ^[2]

[1] Single carrier IS-95 with pilot, paging, sync and 6 traffic channels (Walsh codes 8 - 13). PAR = 9.7 dB at 0.01 % probability on the CCDF. Channel bandwidth is 1.2288 MHz.

[2] Measured within 30 kHz bandwidth.

1.2 Features and benefits

- Typical 1-carrier N-CDMA performance (single carrier IS-95 with pilot, paging, sync and 6 traffic channels [Walsh codes 8 - 13]. PAR = 9.7 dB at 0.01 % probability on the CCDF. Channel bandwidth is 1.2288 MHz) at a frequency of 3400 MHz, 3500 MHz and 3600 MHz, a supply voltage of 28 V and an I_{Dq} of 225 mA:
 - ◆ Average output power = 4.5 W
 - ◆ Power gain = 15 dB
 - ◆ Drain efficiency = 24 %
 - ◆ ACPR_{885k} = -45 dBc in 30 kHz bandwidth
- Easy power control
- Integrated ESD protection
- Excellent ruggedness
- High efficiency
- Excellent thermal stability
- Designed for broadband operation (3400 MHz to 3800 MHz)
- Internally matched for ease of use
- Compliant to Directive 2002/95/EC, regarding Restriction of Hazardous Substances (RoHS)

1.3 Applications

- RF power amplifiers for base stations and multicarrier applications in the 3400 MHz to 3800 MHz frequency range

2. Pinning information

Table 2. Pinning

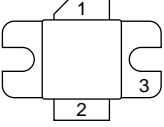
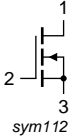
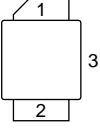
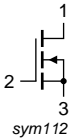
Pin	Description	Simplified outline	Graphic symbol
BLF6G38-25 (SOT608A)			
1	drain		
2	gate		
3	source		
BLF6G38S-25 (SOT608B)			
1	drain		
2	gate		
3	source		

[1] Connected to flange.

3. Ordering information

Table 3. Ordering information

Type number	Package		
	Name	Description	Version
BLF6G38-25	-	flanged ceramic package; 2 mounting holes; 2 leads	SOT608A
BLF6G38S-25	-	ceramic earless flanged package; 2 leads	SOT608B

4. Limiting values

Table 4. Limiting values

In accordance with the Absolute Maximum Rating System (IEC 60134).

Symbol	Parameter	Conditions	Min	Max	Unit
V_{DS}	drain-source voltage		-	65	V
V_{GS}	gate-source voltage		-0.5	+13	V
I_D	drain current		-	8.2	A
T_{stg}	storage temperature		-65	+150	°C
T_j	junction temperature		-	200	°C

5. Thermal characteristics

Table 5. Thermal characteristics

Symbol	Parameter	Conditions	Type	Typ	Max	Unit
$R_{th(j-case)}$	thermal resistance from junction to case	$T_{case} = 80\text{ °C};$ $P_L = 25\text{ W}$	BLF6G38-25	1.8	-	K/W
			BLF6G38S-25	1.8	-	K/W

6. Characteristics

Table 6. Characteristics

$T_j = 25\text{ }^\circ\text{C}$ unless otherwise specified.

Symbol	Parameter	Conditions	Min	Typ	Max	Unit
$V_{(BR)DSS}$	drain-source breakdown voltage	$V_{GS} = 0\text{ V}; I_D = 0.4\text{ mA}$	65	-	-	V
$V_{GS(th)}$	gate-source threshold voltage	$V_{DS} = 10\text{ V}; I_D = 40\text{ mA}$	1.4	2	2.4	V
I_{DSS}	drain leakage current	$V_{GS} = 0\text{ V}; V_{DS} = 28\text{ V}$	-	-	1.5	μA
I_{DSX}	drain cut-off current	$V_{GS} = V_{GS(th)} + 3.75\text{ V}; V_{DS} = 10\text{ V}$	6	8.2	-	A
I_{GSS}	gate leakage current	$V_{GS} = +11\text{ V}; V_{DS} = 0\text{ V}$	-	-	150	nA
g_{fs}	forward transconductance	$V_{DS} = 10\text{ V}; I_D = 1.4\text{ A}$	-	2.8	-	S
$R_{DS(on)}$	drain-source on-state resistance	$V_{GS} = V_{GS(th)} + 3.75\text{ V}; I_D = 1.4\text{ A}$	-	0.37	0.58	Ω
C_{rs}	feedback capacitance	$V_{GS} = 0\text{ V}; V_{DS} = 28\text{ V}; f = 1\text{ MHz}$	-	0.59	-	pF

7. Application information

Table 7. Application information

Mode of operation: 1-carrier N-CDMA; single carrier IS-95 with pilot, paging, sync and 6 traffic channels (Walsh codes 8 - 13); PAR = 9.7 dB at 0.01 % probability on the CCDF; channel bandwidth is 1.2288 MHz; $f_1 = 3400\text{ MHz}; f_2 = 3500\text{ MHz}; f_3 = 3600\text{ MHz}$; RF performance at $V_{DS} = 28\text{ V}; I_{Dq} = 225\text{ mA}; T_{case} = 25\text{ }^\circ\text{C}$; unless otherwise specified, in a class-AB production circuit.

Symbol	Parameter	Conditions	Min	Typ	Max	Unit
G_p	power gain	$P_{L(AV)} = 4.5\text{ W}$	12.5	15	-	dB
RL_{in}	input return loss	$P_{L(AV)} = 4.5\text{ W}$	-	-10	-	dB
η_D	drain efficiency	$P_{L(AV)} = 4.5\text{ W}$	22	24	-	%
$ACPR_{885k}$	adjacent channel power ratio (885 kHz)	$P_{L(AV)} = 4.5\text{ W}$ [1]	-	-45	-40	dBc
$ACPR_{1980k}$	adjacent channel power ratio (1980 kHz)	$P_{L(AV)} = 4.5\text{ W}$ [1]	-	-61	-56	dBc

[1] Measured within 30 kHz bandwidth.

7.1 Ruggedness in class-AB operation

The BLF6G38-25 and BLF6G38S-25 are capable of withstanding a load mismatch corresponding to VSWR = 10 : 1 through all phases under the following conditions: $V_{DS} = 28\text{ V}; I_{Dq} = 225\text{ mA}; P_L = P_{L(1dB)}; f = 3600\text{ MHz}$.

7.2 Ampleon WiMAX signal

7.2.1 WiMAX signal description

frame duration = 5 ms; bandwidth = 10 MHz; sequency = 1 frame;
 frequency band = WCS; sampling rate = 11.2 MHz; $n = 8 / 7$; $G = T_g / T_b = 1 / 8$;
 FFT = 1024; zone type = PUSC; $\delta = 97.7 \%$; number of symbols = 46;
 number of subchannels = 30; PAR = 9.5 dB.

Preamble: 1 symbol \times 30 subchannels; $P_L = P_{L(nom)} + 3.86 \text{ dB}$

Table 8. Frame structure

Frame contents	Modulation technique	Data length
Zone 0 FCH 2 symbols \times 4 subchannels	QPSK1/2	3
Zone 0 data 2 symbols \times 26 subchannels	64QAM3/4	692
Zone 0 data 44 symbols \times 30 subchannels	64QAM3/4	10000

7.2.2 Graphs

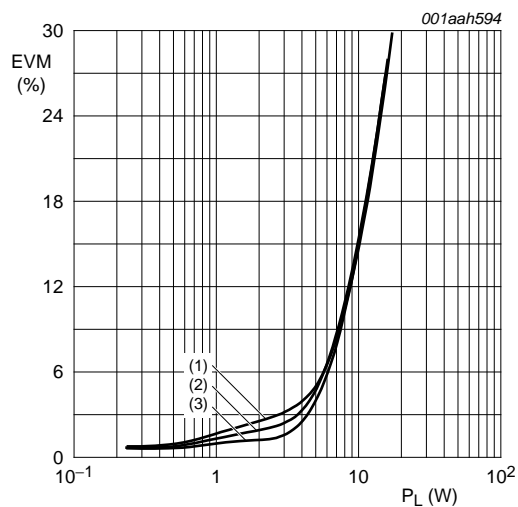

$V_{DS} = 28 \text{ V}$; $I_{Dq} = 225 \text{ mA}$; OFDMA signal;
 frame duration = 5 ms; bandwidth = 10 MHz;
 frequency band = WCS; $n = 28 / 25$; $G = 1 / 8$;
 FFT = 1024; zone type = PUSC;
 number of symbols = 46; number of subchannels = 30.

- (1) $f = 3400 \text{ MHz}$
- (2) $f = 3500 \text{ MHz}$
- (3) $f = 3600 \text{ MHz}$

Fig 1. EVM as function of load power; typical values

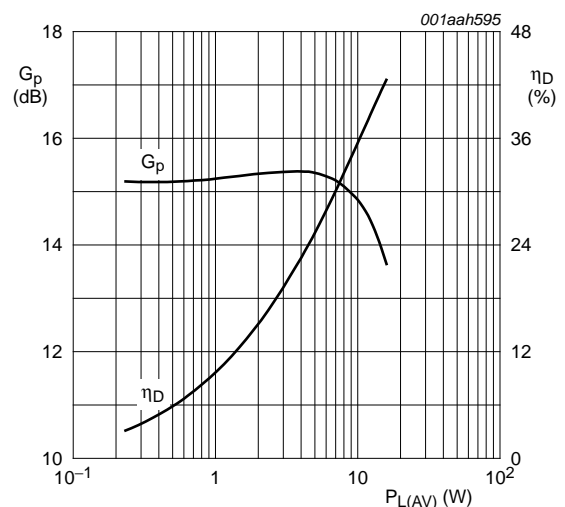

$V_{DS} = 28 \text{ V}$; $I_{Dq} = 225 \text{ mA}$; $f = 3500 \text{ MHz}$; OFDMA signal;
 frame duration = 5 ms; bandwidth = 10 MHz;
 frequency band = WCS; $n = 28 / 25$; $G = 1 / 8$;
 FFT = 1024; zone type = PUSC;
 number of symbols = 46; number of subchannels = 30.

Fig 2. Power gain and drain efficiency as functions of average load power; typical values

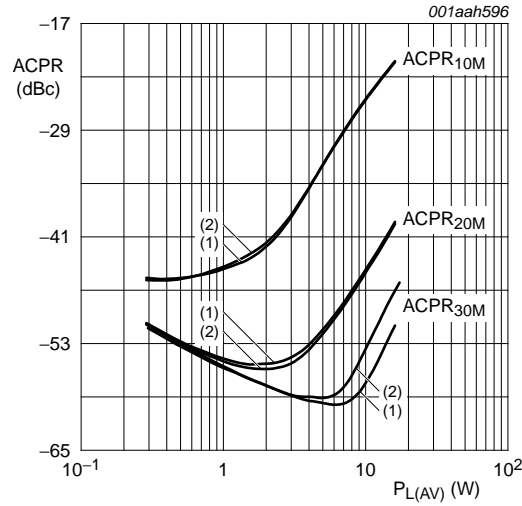

$V_{DS} = 28\text{ V}$; $I_{Dq} = 225\text{ mA}$; $f = 3500\text{ MHz}$; OFDMA signal; frame duration = 5 ms; bandwidth = 10 MHz; frequency band = WCS; $n = 28 / 25$; $G = 1 / 8$; FFT = 1024; zone type = PUSC; number of symbols = 46; number of subchannels = 30.

- (1) Low frequency component
- (2) High frequency component

Fig 3. Adjacent channel power ratio as function of average load power; typical values

7.3 Single carrier N-CDMA broadband performance at 9 W average

7.3.1 Graphs

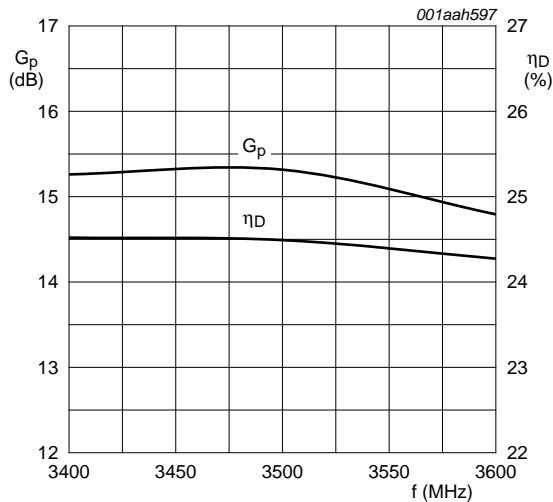

$P_{L(AV)} = 4.5\text{ W}$.

Fig 4. Power gain and drain efficiency as functions of frequency; typical values

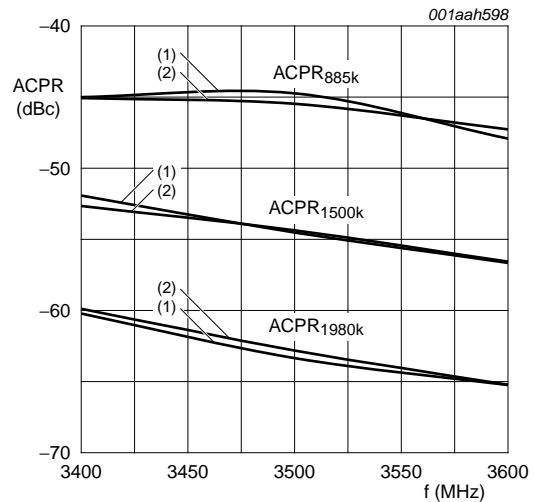

$V_{DS} = 28\text{ V}$; $I_{Dq} = 350\text{ mA}$; $P_{L(AV)} = 4.5\text{ W}$; single carrier N-CDMA; PAR = 9.7 dB at 0.01 % probability; IBW = 30 kHz.

- (1) Low frequency component
- (2) High frequency component

Fig 5. Adjacent channel power ratio as function of frequency; typical values

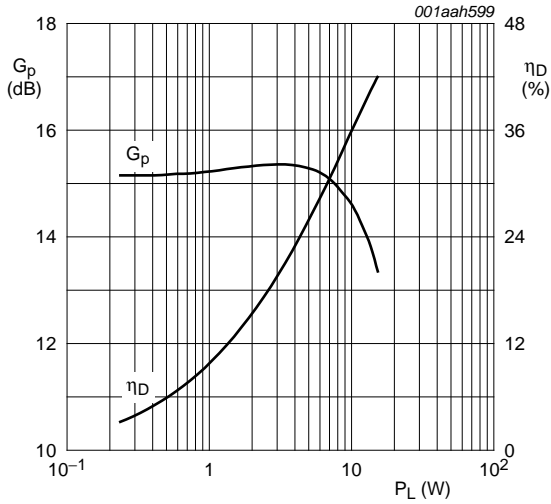

$V_{DS} = 28\text{ V}$; $I_{Dq} = 225\text{ mA}$; $f = 3500\text{ MHz}$; single carrier N-CDMA; PAR = 9.7 dB at 0.01 % probability; channel bandwidth = 1.23 MHz; IBW = 30 kHz.

Fig 6. Power gain and drain efficiency as functions of load power; typical values

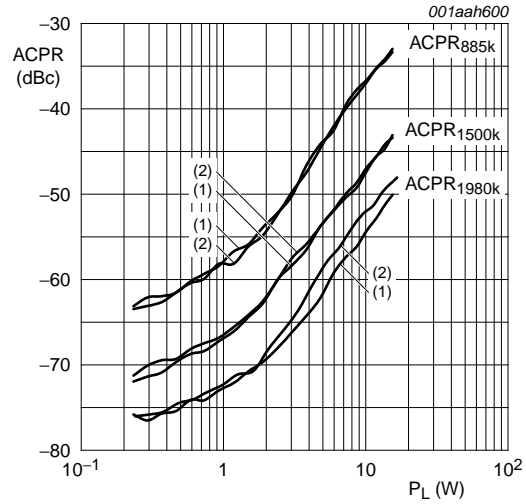

$V_{DS} = 28\text{ V}$; $I_{Dq} = 225\text{ mA}$; $f = 3500\text{ MHz}$; single carrier N-CDMA; PAR = 9.7 dB at 0.01 % probability; channel bandwidth = 1.23 MHz; IBW = 30 kHz.

- (1) Low frequency component
- (2) High frequency component

Fig 7. Adjacent channel power ratio as function of average load power; typical values

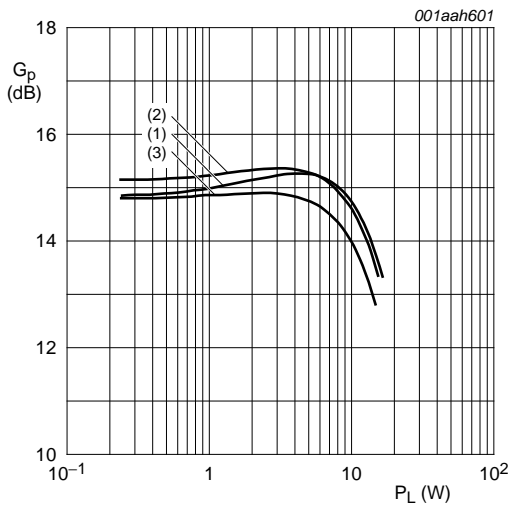

$V_{DS} = 28\text{ V}$; $I_{Dq} = 225\text{ mA}$; single carrier N-CDMA; PAR = 9.7 dB at 0.01 % probability; channel bandwidth = 1.23 MHz; IBW = 30 kHz.

- (1) $f = 3400\text{ MHz}$
- (2) $f = 3500\text{ MHz}$
- (3) $f = 3600\text{ MHz}$

Fig 8. Power gain as function of load power; typical values

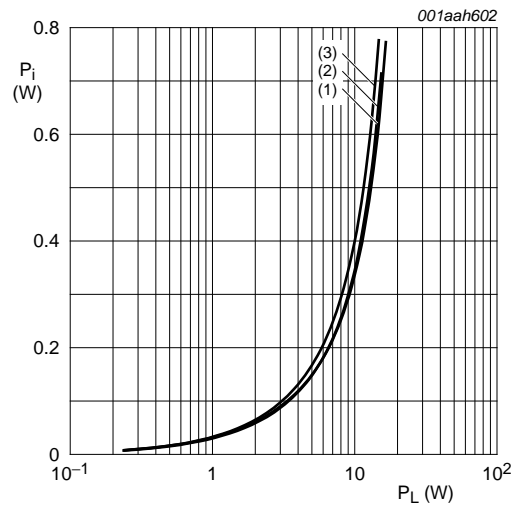

$V_{DS} = 28\text{ V}$; $I_{Dq} = 225\text{ mA}$; single carrier N-CDMA; PAR = 9.7 dB at 0.01 % probability; channel bandwidth = 1.23 MHz; IBW = 30 kHz.

- (1) $f = 3400\text{ MHz}$
- (2) $f = 3500\text{ MHz}$
- (3) $f = 3600\text{ MHz}$

Fig 9. Input power as function of load power; typical values

8. Test information

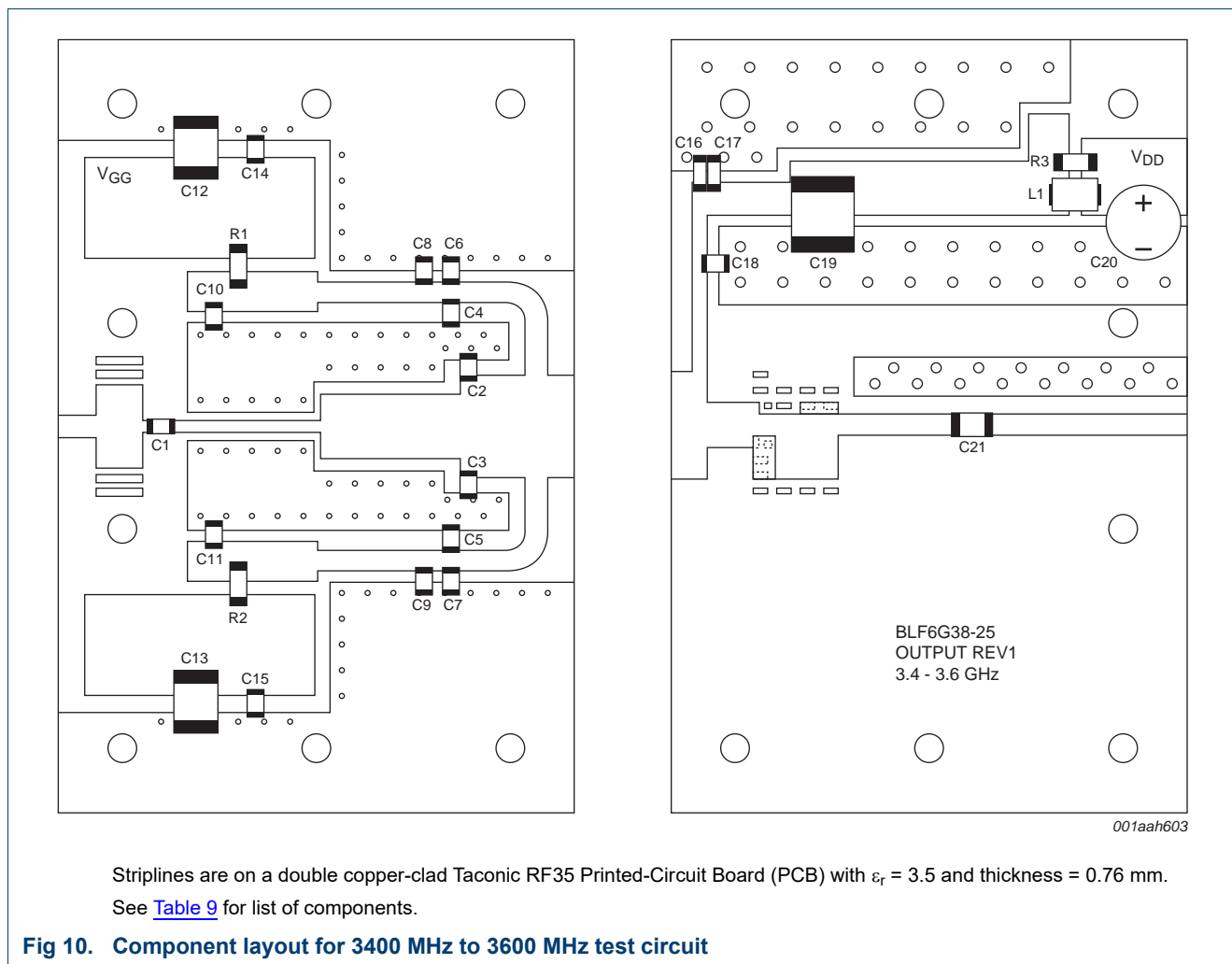

Table 9. List of components (see [Figure 10](#))

Component	Description	Value	Remarks
C1	multilayer ceramic chip capacitor	22 pF	ATC 100A or equivalent
C2, C3	multilayer ceramic chip capacitor	3 pF	ATC 100A or equivalent
C4, C5, C6, C7, C8, C9, C18	multilayer ceramic chip capacitor	10 pF	ATC 100A or equivalent
C10, C11	multilayer ceramic chip capacitor	24 pF	ATC 100A or equivalent
C12, C13	multilayer ceramic chip capacitor	4.7 μ F; 50 V	TDK C4532X7R1H475M or equivalent
C14, C15	multilayer ceramic chip capacitor	1 nF	ATC 700A or equivalent
C16, C17	multilayer ceramic chip capacitor	100 nF	Vishay VJ1206Y104KXB or equivalent
C19	multilayer ceramic chip capacitor	10 μ F; 50 V	TDK C5750X7R1H106M or equivalent
C20	electrolytic capacitor	470 μ F; 63 V	
C21	multilayer ceramic chip capacitor	10 pF	ATC 100B or equivalent

Table 9. List of components (see Figure 10) ...continued

Component	Description	Value	Remarks
L1	ferrite SMD bead	-	Ferroxcube BDS3/3/4.6-4S2 or equivalent
R1, R2	SMD resistor	20 Ω	SMD 1206
R3	SMD resistor	9.1 Ω	SMD 1206

Table 10. Measured test circuit impedances

f MHz	Z _S Ω	Z _L Ω
3400	14.65 + j29.87	13.46 + j3.58
3450	14.16 + j28.69	13.56 + j4.12
3500	14.56 + j30.52	13.76 + j4.74
3550	17.49 + j30.11	13.97 + j5.41
3600	15.50 + j29.36	14.16 + j5.95

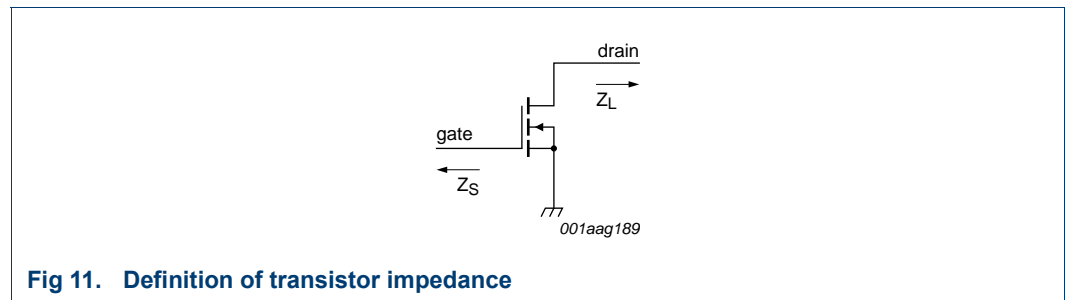

Fig 11. Definition of transistor impedance

9. Package outline

Flanged ceramic package; 2 mounting holes; 2 leads

SOT608A

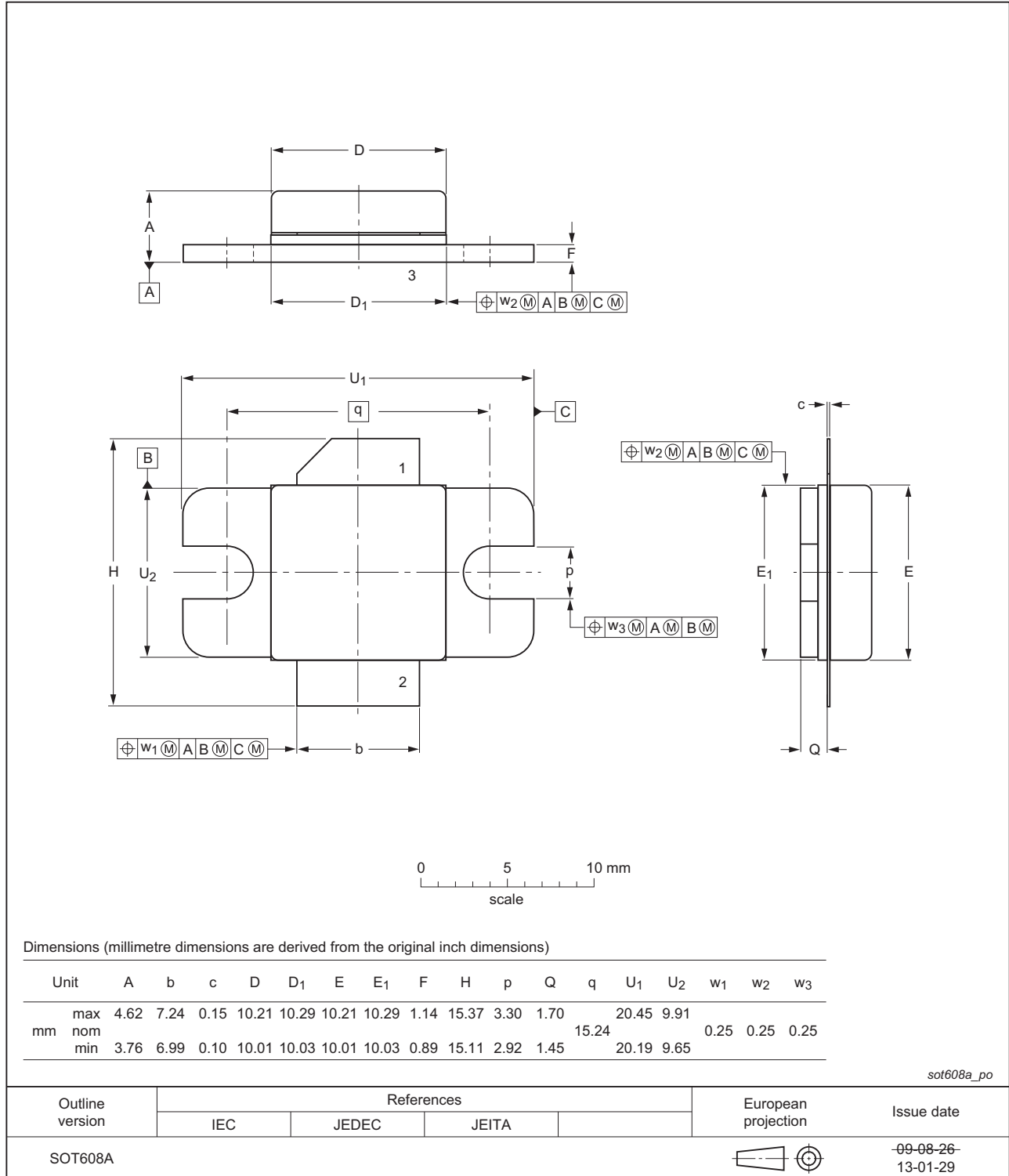

Fig 12. Package outline SOT608A

Ceramic earless flanged package; 2 leads

SOT608B

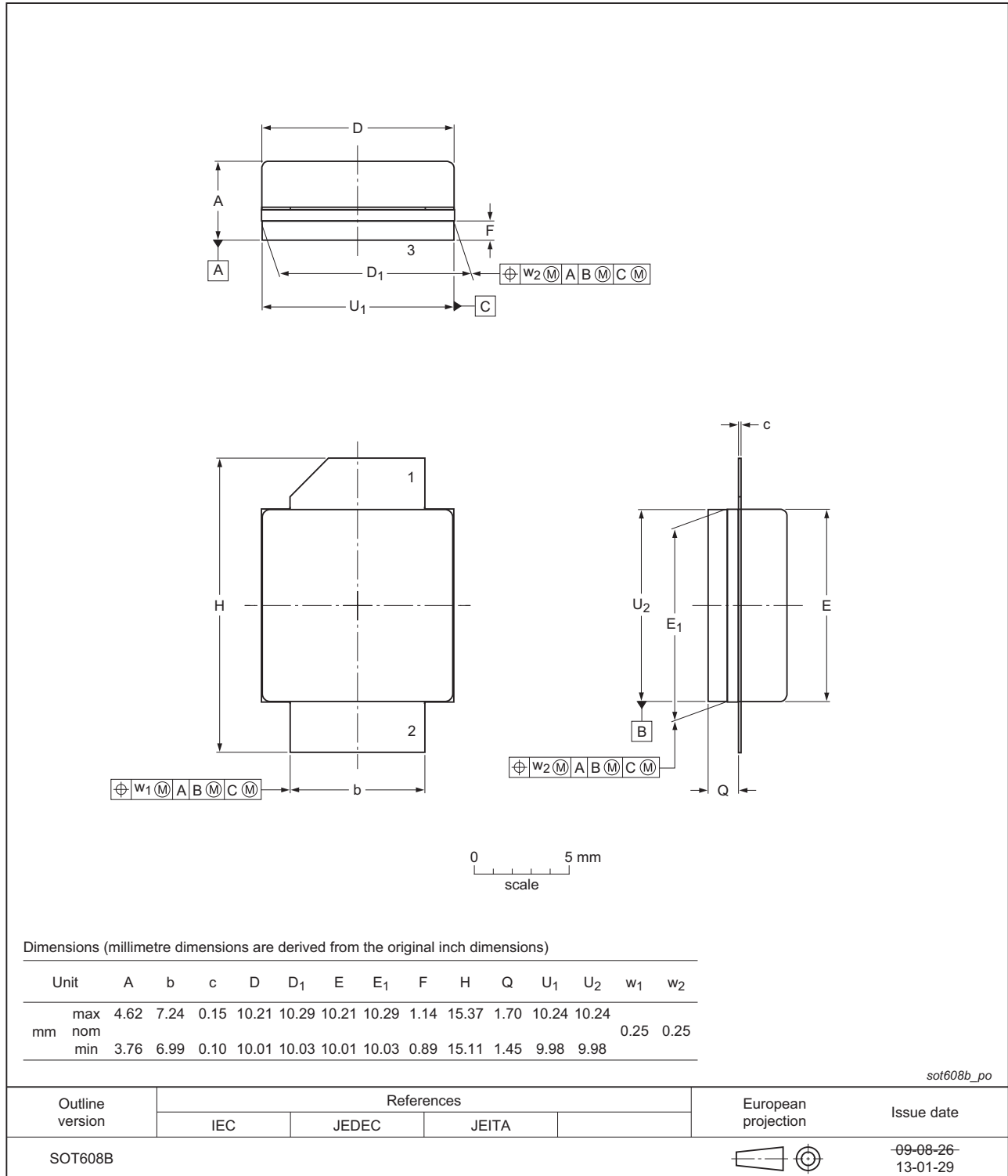

Fig 13. Package outline SOT608B

10. Abbreviations

Table 11. Abbreviations

Acronym	Description
CCDF	Complementary Cumulative Distribution Function
CW	Continuous Wave
ESD	ElectroStatic Discharge
EVM	Error Vector Magnitude
FCH	Frame Control Header
FFT	Fast Fourier Transform
IBW	Instantaneous BandWidth
IS-95	Interim Standard 95
LDMOS	Laterally Diffused Metal-Oxide Semiconductor
N-CDMA	Narrowband Code Division Multiple Access
OFDMA	Orthogonal Frequency Division Multiple Access
PAR	Peak-to-Average power Ratio
PUSC	Partial Usage of SubChannels
RF	Radio Frequency
QAM	Quadrature Amplitude Modulation
QPSK	Quadrature Phase Shift Keying
SMD	Surface Mounted Device
VSWR	Voltage Standing-Wave Ratio
WCS	Wireless Communications Service
WiMAX	Worldwide Interoperability for Microwave Access

11. Revision history

Table 12. Revision history

Document ID	Release date	Data sheet status	Change notice	Supersedes
BLF6G38-25_BLF6G38S-25#4	20150901	Product data sheet	-	BLF6G38-25_BLF6G38S-25 v.3
Modifications:	<ul style="list-style-type: none"> The format of this document has been redesigned to comply with the new identity guidelines of Ampleon. Legal texts have been adapted to the new company name where appropriate. 			
BLF6G38-25_BLF6G38S-25 v.3	20130311	Product data sheet	-	BLF6G38-25_BLF6G38S-25_2
BLF6G38-25_BLF6G38S-25_2	20081223	Product data sheet	-	BLF6G38-25_BLF6G38S-25_1
BLF6G38-25_BLF6G38S-25_1	20080218	Preliminary data sheet	-	-

12. Legal information

12.1 Data sheet status

Document status ^{[1][2]}	Product status ^[3]	Definition
Objective [short] data sheet	Development	This document contains data from the objective specification for product development.
Preliminary [short] data sheet	Qualification	This document contains data from the preliminary specification.
Product [short] data sheet	Production	This document contains the product specification.

[1] Please consult the most recently issued document before initiating or completing a design.

[2] The term 'short data sheet' is explained in section "Definitions".

[3] The product status of device(s) described in this document may have changed since this document was published and may differ in case of multiple devices. The latest product status information is available on the Internet at URL <http://www.ampleon.com>.

12.2 Definitions

Draft — The document is a draft version only. The content is still under internal review and subject to formal approval, which may result in modifications or additions. Ampleon does not give any representations or warranties as to the accuracy or completeness of information included herein and shall have no liability for the consequences of use of such information.

Short data sheet — A short data sheet is an extract from a full data sheet with the same product type number(s) and title. A short data sheet is intended for quick reference only and should not be relied upon to contain detailed and full information. For detailed and full information see the relevant full data sheet, which is available on request via the local Ampleon sales office. In case of any inconsistency or conflict with the short data sheet, the full data sheet shall prevail.

Product specification — The information and data provided in a Product data sheet shall define the specification of the product as agreed between Ampleon and its customer, unless Ampleon and customer have explicitly agreed otherwise in writing. In no event however, shall an agreement be valid in which the Ampleon product is deemed to offer functions and qualities beyond those described in the Product data sheet.

12.3 Disclaimers

Limited warranty and liability — Information in this document is believed to be accurate and reliable. However, Ampleon does not give any representations or warranties, expressed or implied, as to the accuracy or completeness of such information and shall have no liability for the consequences of use of such information. Ampleon takes no responsibility for the content in this document if provided by an information source outside of Ampleon.

In no event shall Ampleon be liable for any indirect, incidental, punitive, special or consequential damages (including - without limitation - lost profits, lost savings, business interruption, costs related to the removal or replacement of any products or rework charges) whether or not such damages are based on tort (including negligence), warranty, breach of contract or any other legal theory.

Notwithstanding any damages that customer might incur for any reason whatsoever, Ampleon' aggregate and cumulative liability towards customer for the products described herein shall be limited in accordance with the *Terms and conditions of commercial sale* of Ampleon.

Right to make changes — Ampleon reserves the right to make changes to information published in this document, including without limitation specifications and product descriptions, at any time and without notice. This document supersedes and replaces all information supplied prior to the publication hereof.

Suitability for use — Ampleon products are not designed, authorized or warranted to be suitable for use in life support, life-critical or safety-critical systems or equipment, nor in applications where failure or malfunction of an

Ampleon product can reasonably be expected to result in personal injury, death or severe property or environmental damage. Ampleon and its suppliers accept no liability for inclusion and/or use of Ampleon products in such equipment or applications and therefore such inclusion and/or use is at the customer's own risk.

Applications — Applications that are described herein for any of these products are for illustrative purposes only. Ampleon makes no representation or warranty that such applications will be suitable for the specified use without further testing or modification.

Customers are responsible for the design and operation of their applications and products using Ampleon products, and Ampleon accepts no liability for any assistance with applications or customer product design. It is customer's sole responsibility to determine whether the Ampleon product is suitable and fit for the customer's applications and products planned, as well as for the planned application and use of customer's third party customer(s). Customers should provide appropriate design and operating safeguards to minimize the risks associated with their applications and products.

Ampleon does not accept any liability related to any default, damage, costs or problem which is based on any weakness or default in the customer's applications or products, or the application or use by customer's third party customer(s). Customer is responsible for doing all necessary testing for the customer's applications and products using Ampleon products in order to avoid a default of the applications and the products or of the application or use by customer's third party customer(s). Ampleon does not accept any liability in this respect.

Limiting values — Stress above one or more limiting values (as defined in the Absolute Maximum Ratings System of IEC 60134) will cause permanent damage to the device. Limiting values are stress ratings only and (proper) operation of the device at these or any other conditions above those given in the Recommended operating conditions section (if present) or the Characteristics sections of this document is not warranted. Constant or repeated exposure to limiting values will permanently and irreversibly affect the quality and reliability of the device.

Terms and conditions of commercial sale — Ampleon products are sold subject to the general terms and conditions of commercial sale, as published at <http://www.ampleon.com/terms>, unless otherwise agreed in a valid written individual agreement. In case an individual agreement is concluded only the terms and conditions of the respective agreement shall apply. Ampleon hereby expressly objects to applying the customer's general terms and conditions with regard to the purchase of Ampleon products by customer.

No offer to sell or license — Nothing in this document may be interpreted or construed as an offer to sell products that is open for acceptance or the grant, conveyance or implication of any license under any copyrights, patents or other industrial or intellectual property rights.

Export control — This document as well as the item(s) described herein may be subject to export control regulations. Export might require a prior authorization from competent authorities.

Non-automotive qualified products — Unless this data sheet expressly states that this specific Ampleon product is automotive qualified, the product is not suitable for automotive use. It is neither qualified nor tested in accordance with automotive testing or application requirements. Ampleon accepts no liability for inclusion and/or use of non-automotive qualified products in automotive equipment or applications.

In the event that customer uses the product for design-in and use in automotive applications to automotive specifications and standards, customer (a) shall use the product without Ampleon' warranty of the product for such automotive applications, use and specifications, and (b) whenever customer uses the product for automotive applications beyond Ampleon' specifications such use shall be solely at customer's own risk, and (c) customer fully indemnifies Ampleon for any liability, damages or failed product claims resulting from customer design and use of the product for automotive applications beyond Ampleon' standard warranty and Ampleon' product specifications.

Translations — A non-English (translated) version of a document is for reference only. The English version shall prevail in case of any discrepancy between the translated and English versions.

13. Contact information

For more information, please visit:
<http://www.ampleon.com>

12.4 Trademarks

Notice: All referenced brands, product names, service names and trademarks are the property of their respective owners.

Any reference or use of any 'NXP' trademark in this document or in or on the surface of Ampleon products does not result in any claim, liability or entitlement vis-à-vis the owner of this trademark. Ampleon is no longer part of the NXP group of companies and any reference to or use of the 'NXP' trademarks will be replaced by reference to or use of Ampleon's own Any reference or use of any 'NXP' trademark in this document or in or on the surface of Ampleon products does not result in any claim, liability or entitlement vis-à-vis the owner of this trademark. Ampleon is no longer part of the NXP group of companies and any reference to or use of the 'NXP' trademarks will be replaced by reference to or use of Ampleon's own trademarks.

For sales office addresses, please visit:
<http://www.ampleon.com/sales>

14. Contents

1	Product profile	1
1.1	General description	1
1.2	Features and benefits	1
1.3	Applications	1
2	Pinning information	2
3	Ordering information	2
4	Limiting values	2
5	Thermal characteristics	2
6	Characteristics	3
7	Application information	3
7.1	Ruggedness in class-AB operation	3
7.2	Ampleon WiMAX signal	4
7.2.1	WiMAX signal description	4
7.2.2	Graphs	4
7.3	Single carrier N-CDMA broadband performance at 9 W average	5
7.3.1	Graphs	5
8	Test information	7
9	Package outline	9
10	Abbreviations	11
11	Revision history	11
12	Legal information	12
12.1	Data sheet status	12
12.2	Definitions	12
12.3	Disclaimers	12
12.4	Trademarks	13
13	Contact information	13
14	Contents	14

Please be aware that important notices concerning this document and the product(s) described herein, have been included in section 'Legal information'.

© Ampleon The Netherlands B.V. 2015. All rights reserved.

For more information, please visit: <http://www.ampleon.com>
 For sales office addresses, please visit: <http://www.ampleon.com/sales>

Date of release: 1 September 2015

Document identifier: BLF6G38-25_BLF6G38S-25#4