

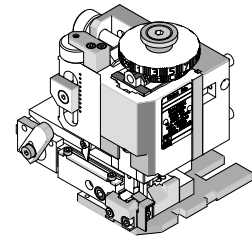

**FineAdjust  
Applicator**

**Application Tooling  
Specification Sheet**



**Order No. 63868-1000**

**FEATURES**

- Quick punch removal with the push of a button for fast and easy tooling change
- Applicator designed to industry standard mounting and shut height 135.80mm (5.346")
- Quick set-up time; plus the crimp height, track and feed adjustments can be set without removing the applicator from the press
- Fine adjustment allows users to achieve target with little effort by adjusting in increments of .015mm (.0006") for conductor crimp height and .063mm (.0025") for insulation height
- Independent adjustment rings allow users to quickly adjust the conductor or insulation crimp height without affecting each other
- Directly adapts to most automatic wire processing machines

**SCOPE**

Products: Contact Pin and Contact Socket (Hooded) 16-18 AWG – See 63868-1100 for different insulation diameters out of this range.

Terminal Series No.	Terminal Order No.				Wire Size		Insulation Diameter		Strip Length	
					AWG	mm <sup>2</sup>	mm	In.	mm	In.
84524	84524-0004	84524-0014			16-18	1.31-0.82	1.40-1.79	.055-.070	3.81-5.08	.150-.200
84525	84525-0009	84525-0032			16-18	1.31-0.82	1.40-1.79	.055-.070	3.81-5.08	.150-.200
84590	84590-0020	84590-0025	84590-0026	84590-0031	16-18	1.31-0.82	1.40-1.79	.055-.070	3.81-5.08	.150-.200

**DEFINITION OF TERMS**

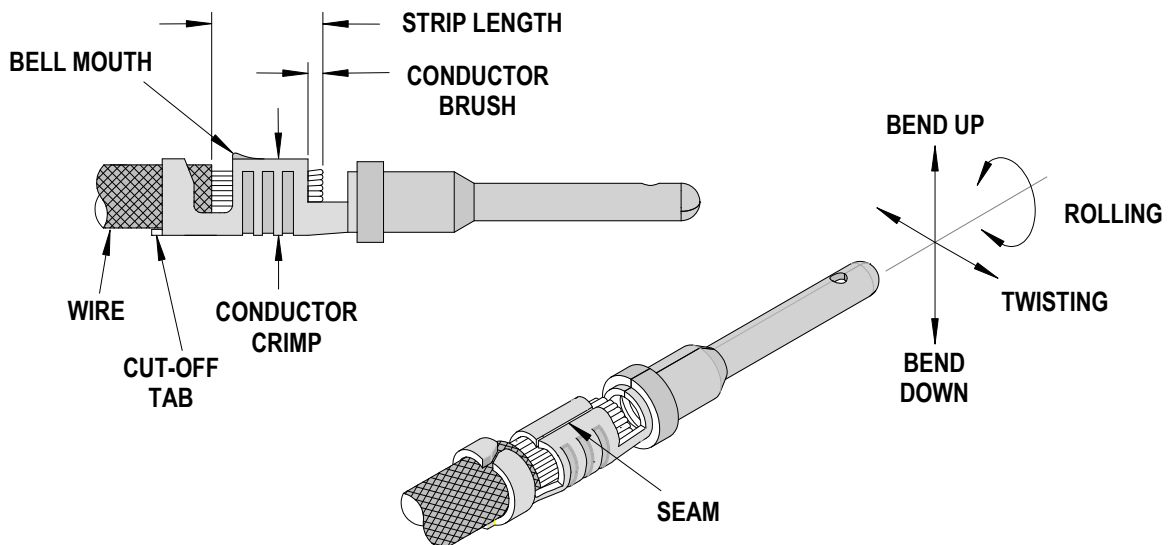

**CRIMP SPECIFICATION**

Terminal Series No.	Bell mouth		Cut-off Tab Max.		Conductor Brush	
	mm	In.	mm	In.	mm	In.
84524	0.30-0.60	.012-.024	0.50	.020	0.30-0.80	.012-.032
84525	0.30-0.60	.012-.024	0.50	.020	0.30-0.80	.012-.032
84590	0.30-0.60	.012-.024	0.50	.020	0.30-0.80	.012-.032

Terminal Series No.	Bend up	Bend down	Twist	Roll	Punch Width (Ref)				Seam Seam shall not be open and no wire allowed out of the crimping area
					Conductor		Insulation		
	Degree		Degree		mm	In	mm	In	
84524	3 °	3 °	4 °	8 °	2.30	.090	2.20	.087	
84525	3 °	3 °	4 °	8 °	2.30	.090	2.20	.087	
84590	3 °	3 °	4 °	8 °	2.30	.090	2.20	.087	

After crimping, the crimp profiles should measure the following:

Terminal Series No.	Wire Size		Conductor				Pull Force Minimum	
			Crimp Height		Crimp Width (Ref)			
	AWG	mm <sup>2</sup>	mm	In.	mm	In.	N	Lb.
84524	16	1.31	1.46-1.54	.057-.060	2.30-2.50	.090-.098	111.3	25
	18	0.82	1.26-1.34	.050-.053	2.30-2.50	.090-.098	111.3	25
84525	16	1.31	1.46-1.54	.057-.060	2.30-2.50	.090-.098	111.3	25
	18	0.82	1.26-1.34	.050-.053	2.30-2.50	.090-.098	111.3	25
84590	16	1.31	1.46-1.54	.057-.060	2.30-2.50	.090-.098	111.3	25
	18	0.82	1.26-1.34	.050-.053	2.30-2.50	.090-.098	111.3	25

Tool Qualification Notes:

1. This Applicator was qualified to the above specifications with UL 1061 wire.
2. Pull Force should be measured with no influence from the insulation crimp.
3. The above specifications are guidelines to an optimum crimp.

**PARTS LIST**

<b>FineAdjust Applicator 63868-1000</b>				
<b>Item</b>	<b>Order No</b>	<b>Engineering No.</b>	<b>Description</b>	<b>Quantity</b>
<b>Perishable Tooling</b>				
	63868-1070	63868-1070	Tool Kit (All "Y" Items)	REF
1	63457-0028	63457-0028	Conductor Punch	1 Y
2	63445-2319	63445-2319	Conductor Anvil	1 Y
3	63454-0039	63454-0039	Insulation Punch	1 Y
4	63445-2236	63445-2236	Insulation Anvil	1 Y
5	63443-0037	63443-0037	Cut-Off Plunger Front	1 Y
6	63443-0038	63443-0038	Plunger Retainer Front	1 Y
<b>Other Components</b>				
7	11-17-0022	1739-21	Compression Spring	1
8	11-18-4083	60707-8	Front Cover	1
9	11-18-4456	60739A109	Wire Hold Down Spring	1
10	11-24-1149	4996-37	Shank	1
11	63443-0009	63443-0009	Scrap Chute Front	1
12	63443-0021	63443-0021	Lower Tooling Key	1
13	63443-0061	63443-0061	Wire Stop	1
14	63443-2801	63443-2801	Plunger Striker Front	1
15	63443-1168	63443-1168	Blade-Wire Hold Down	1
16	63443-1169	63443-1169	Terminal Hold Down	1
17	63443-2518	63443-2518	Anvil Mount	1
18	63443-2912	63443-2912	Wire Hold-Down Plunger	1
19	63443-6121	63443-6121	Rear Cover	1
20	63600-0021	63600-0021	Spring-Compression	1
21	63600-2673	63600-2673	Mini Rod	1
22	63700-0539	63700-0539	Cut-off Plunger Spring	1
<b>Frame</b>				
23	63800-4901	63800-4901	Top	1
24	63801-3281	63801-3281	Base	1
25	63801-4650	63801-4650	Track	1
<b>Hardware</b>				
26	N/A	N/A	M3 by 6 Long SHCS	2**
27	N/A	N/A	M4 by 6 Long SHCS	1**
28	N/A	N/A	M4 by 12 Long BHCS	2**
29	N/A	N/A	M4 by 50 Long SHCS	2**
30	N/A	N/A	M5 by 12 Long SHCS	1**
31	N/A	N/A	2mm by 5 Long Roll Pin	1**
32	N/A	N/A	3mm by 6 Long Roll Pin	1**
33	N/A	N/A	#5-40 by 3/8" Long SHCS	1**
34	N/A	N/A	#10-32 by 5/32" Long BHCS	1**
** Available from an industrial supply company such as MSC (1-800-645-7270).				

# Assembly Drawing

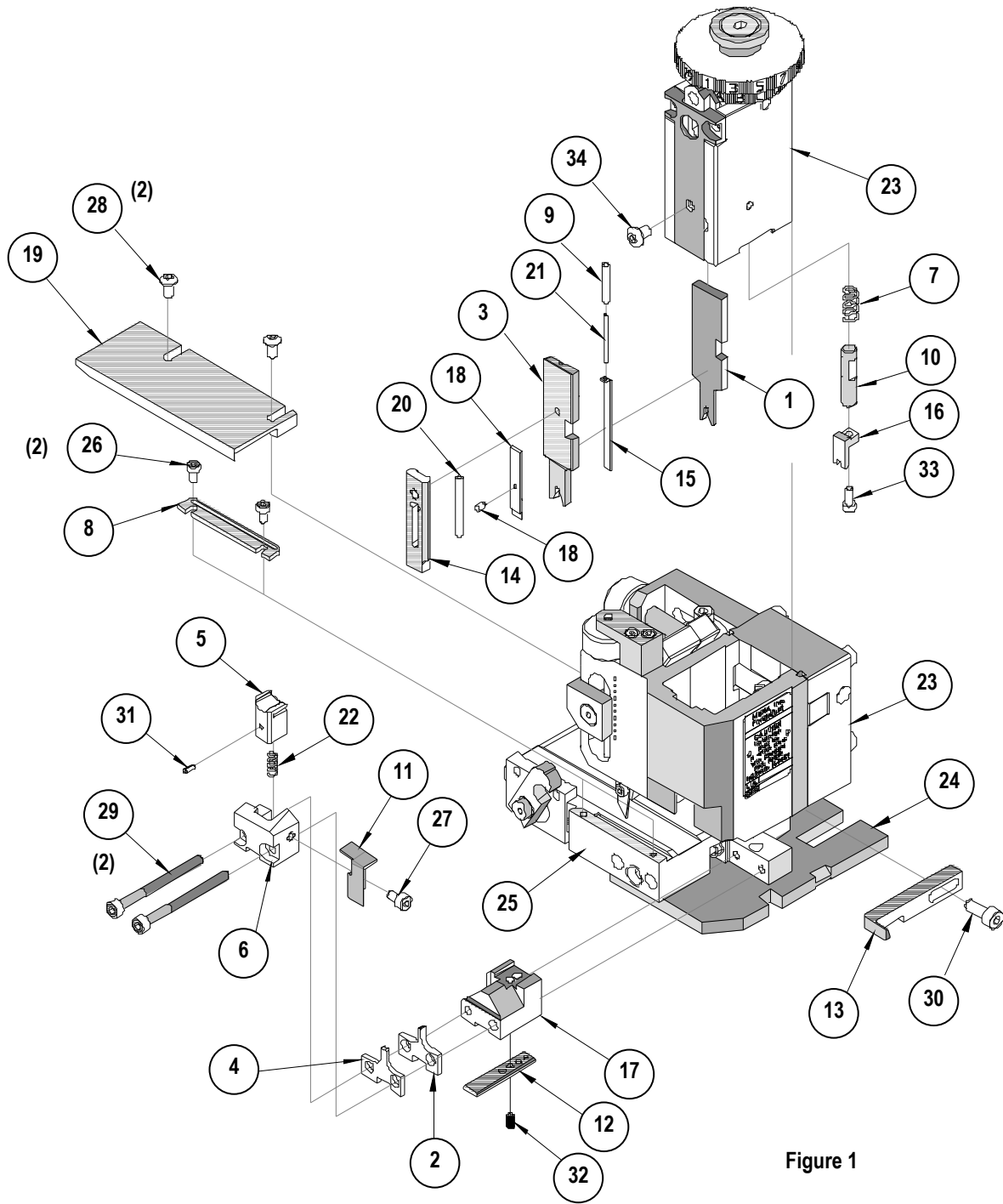

Figure 1

## NOTES

1. Molex recommends an extra perishable tooling kit be maintained at your facility.
2. Verify tooling alignment by manually cycling the press and Applicator before crimping under power. Check that all screws are tight.
3. Slugs, Terminals, Dirt and Oil should be kept clear of work area.
4. Wear safety glasses at all times.
5. For recommended maintenance refer to the FineAdjust Manual.

**CAUTION:** This applicator should only be used in a press with a shut height of 135.80 mm (5.346"). Tooling damage could result at a lower setting.

**CAUTION:** To prevent injury never operate this Applicator without the guards supplied with the press or wire-processing machine in place. Reference the press or wire processing manufacturer's instruction manual.

**CAUTION:** Molex crimp specifications are valid only when used with Molex terminals, applicators and tooling.

<http://www.molex.com>