

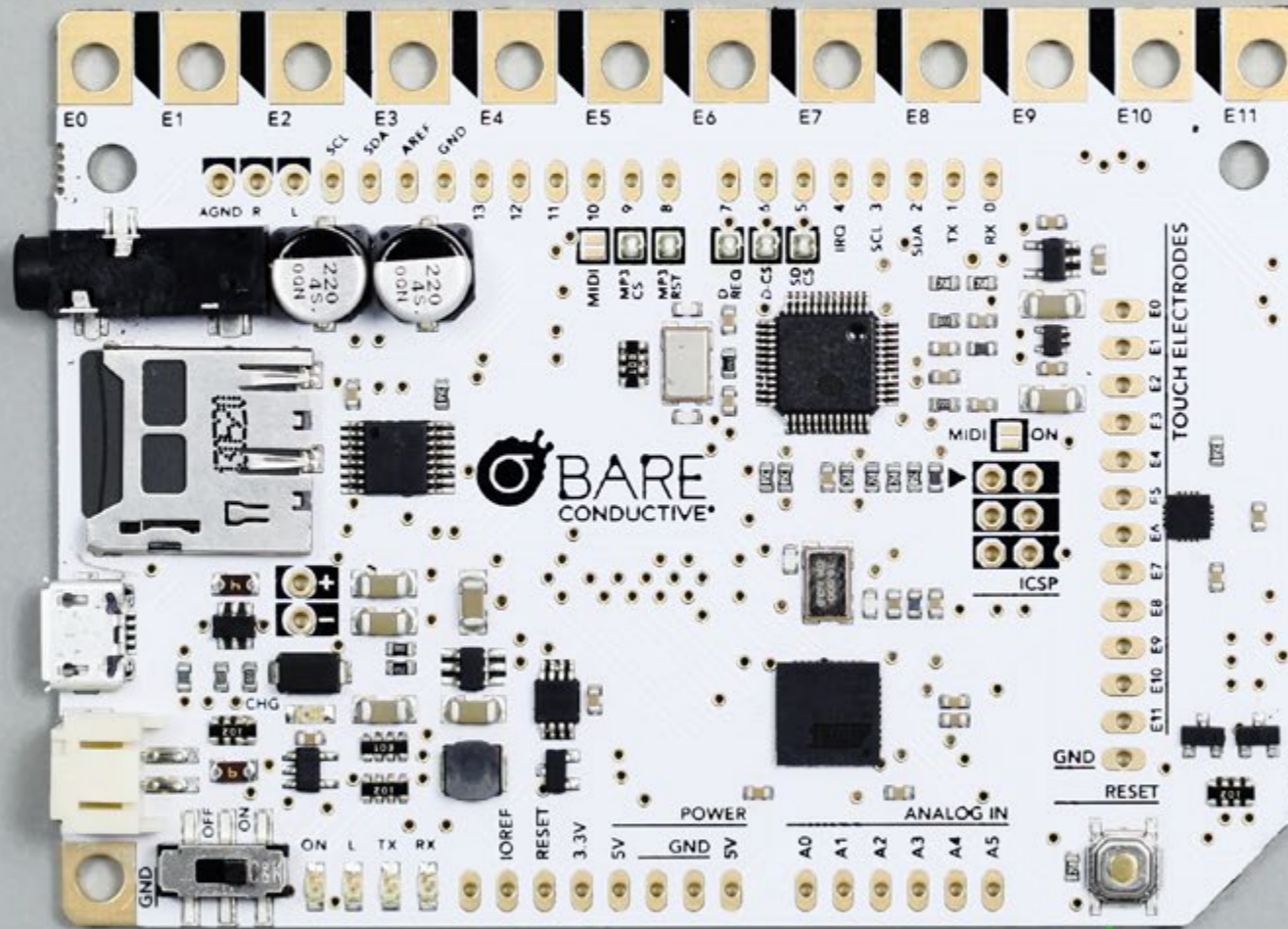

WORKSHOP MANUAL



HELLO

How to use this document **3**

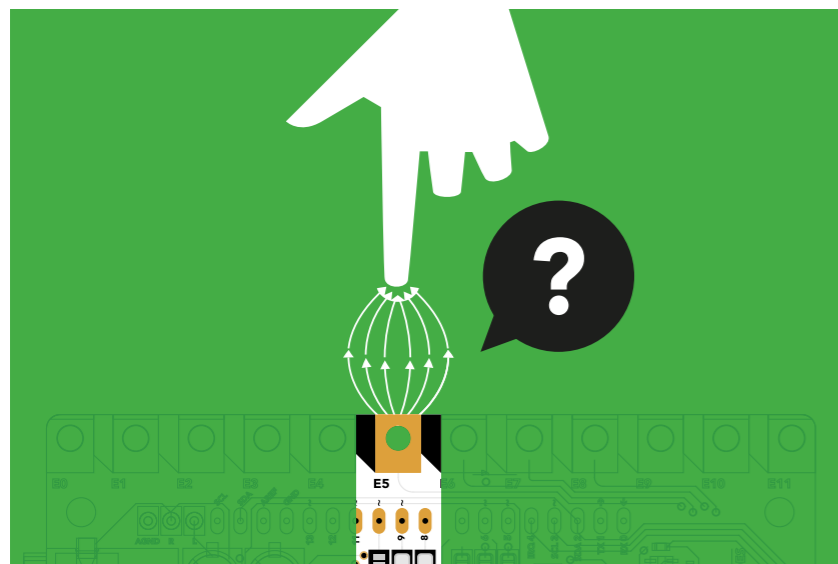

DEFINITIONS **4 – 13**



EQUIPMENT AND SETUP **14 – 17**



WORKSHOP STRUCTURE **18 – 21**

WORKSHOP MANUAL

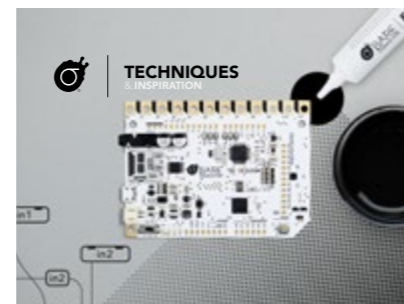

How to use this document

The **Touch Board Workshop Manual** has been designed to help you organise and lead a workshop using **Electric Paint** and the **Touch Board**. It will take you from learning the basics, through set up, and all the way to running a workshop.



- SENSORS
- SWITCHES
- CIRCUITS
- COLD SOLDER
- PAINT
- SCREEN PRINT

ELECTRIC PAINT

It works like any other water-based paint, except it conducts electricity

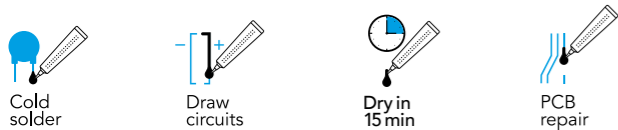

What can it be used for?

Paint wires or sensors directly onto almost any material, safely and quickly cold solder components, repair small devices and PCBs, or create switches and circuit designs straight onto any material.

Why is it special?

It's electrically conductive, non-toxic, solvent free and water soluble. You can also stencil and screen print with it, just like a normal paint. Although not as conductive as metal or copper wire, it's a great tool for low-current circuits and sensors.

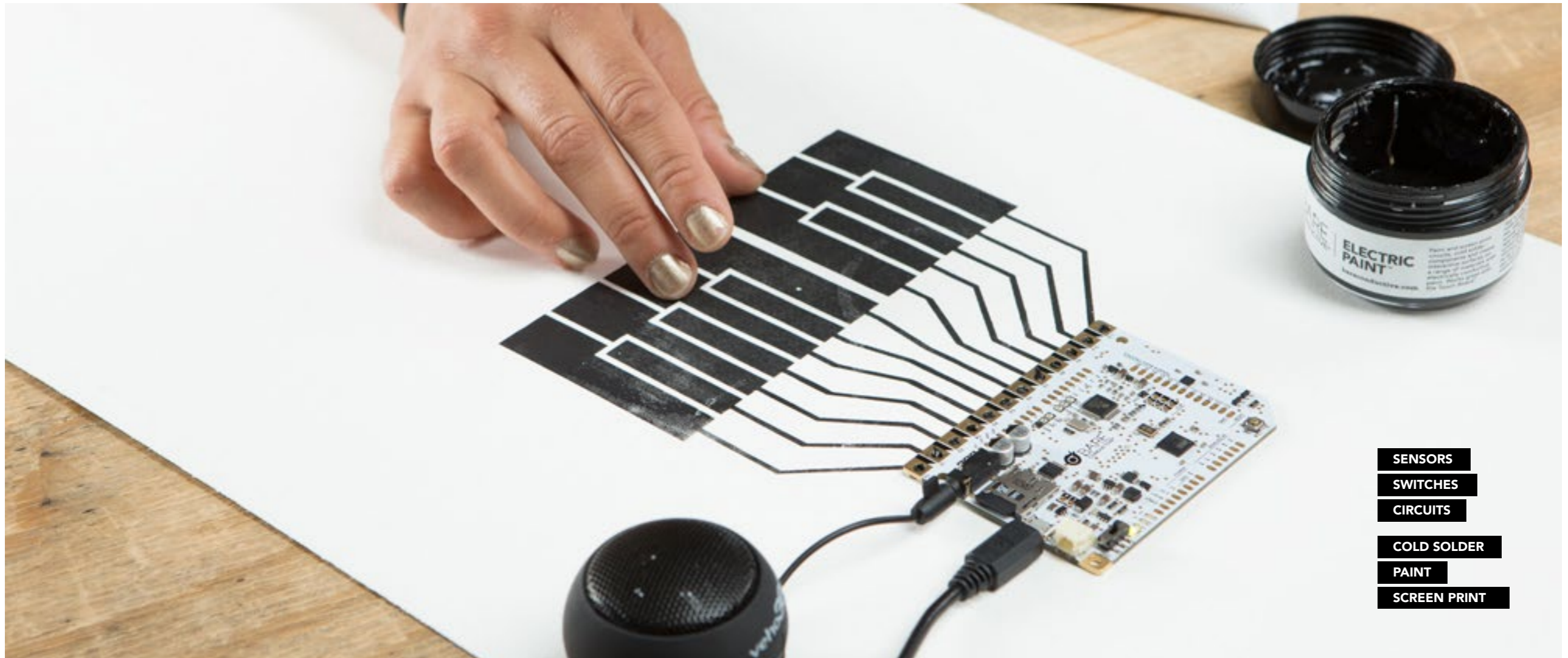

SENSORS

SWITCHES

CIRCUITS

COLD SOLDER

PAINT

SCREEN PRINT

TOUCH BOARD

A plug and play microcontroller board which lets you turn almost any material or surface into a sensor

What can it be used for?

Make custom instruments, interactive surfaces, or even light switches. Connect anything conductive to its 12 electrodes to make your own sensors, then make music, control visuals or create alarms — any output you want!

Why is it special?

It uses capacitive sensing, so you can trigger its electrodes without direct contact. Calibrate it to sense touch or distance, or program it just like an Arduino to create lots of projects straight from the box.

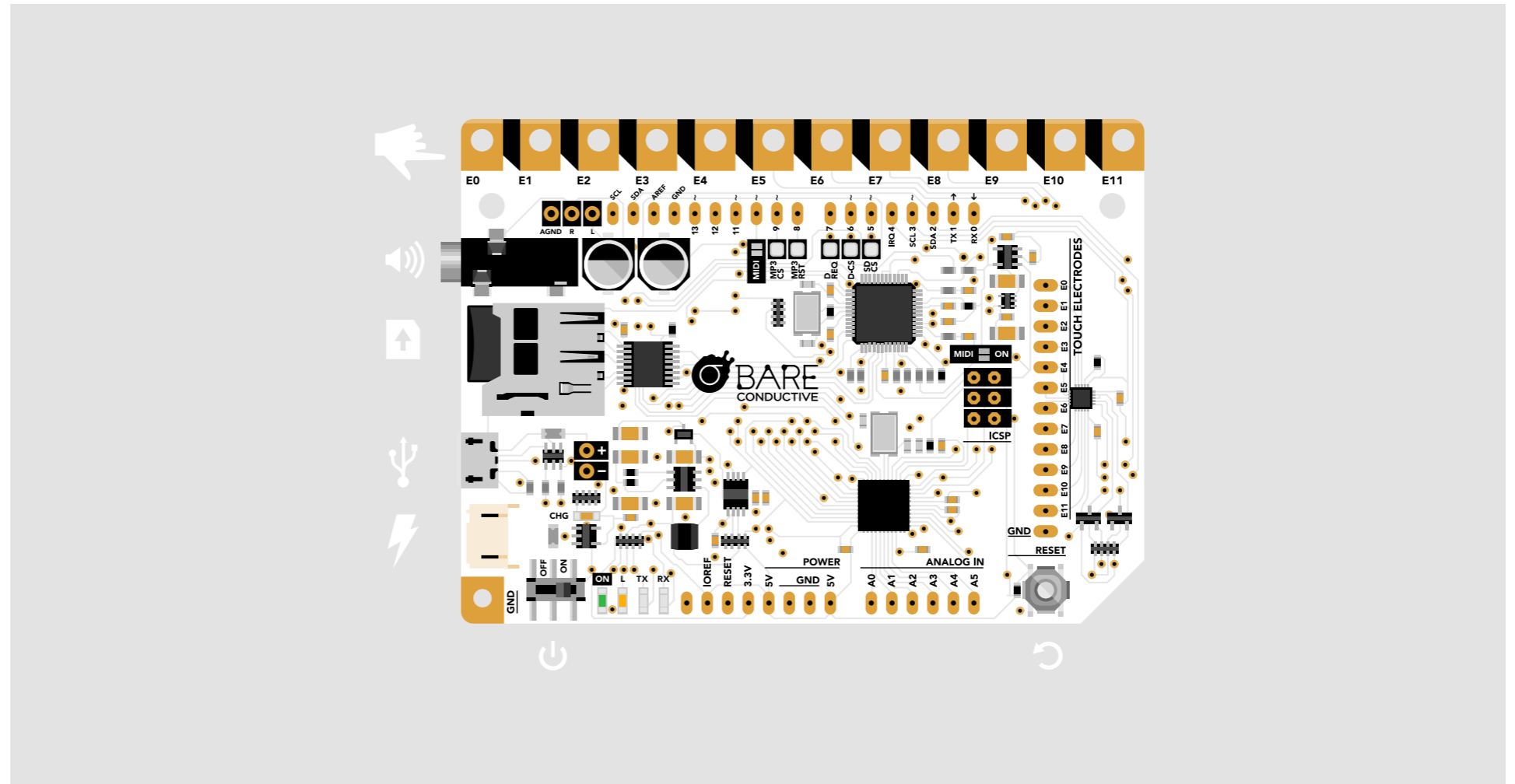

What is on my Touch Board

A quick navigation guide to the Touch Board components and features

 **ON / OFF SWITCH**

 **SPEAKER / HEADPHONE JACK**

 **USB MINI**

Plug in here to power your board through USB or to reprogram it via your computer.

 **3.7V LIPO BATTERY CHARGER**

Don't want your board to be cable connected? Use a rechargeable LiPo* battery for stand-alone projects.

 **TOUCH SENSORS / ELECTRODES**

 The electrodes are mini sensors that detect touch or proximity*. Connect them to anything conductive to turn that object into a sensor. Electric Paint can

be used to make graphical sensors too.

MICRO SD CARD READER



To change your sounds, just replace the MP3 files on the SD card using our track naming system. Remember to always switch off the board before removing the card.

RESET BUTTON



Recalibrate the board each time you connect something new to the electrodes. Press this button and wait for the red light (LED) to stop flashing.

*LiPo (Lithium Polymer) battery a rechargeable battery of lithium-ion technology. / *Proximity Nearness in space. Distance.

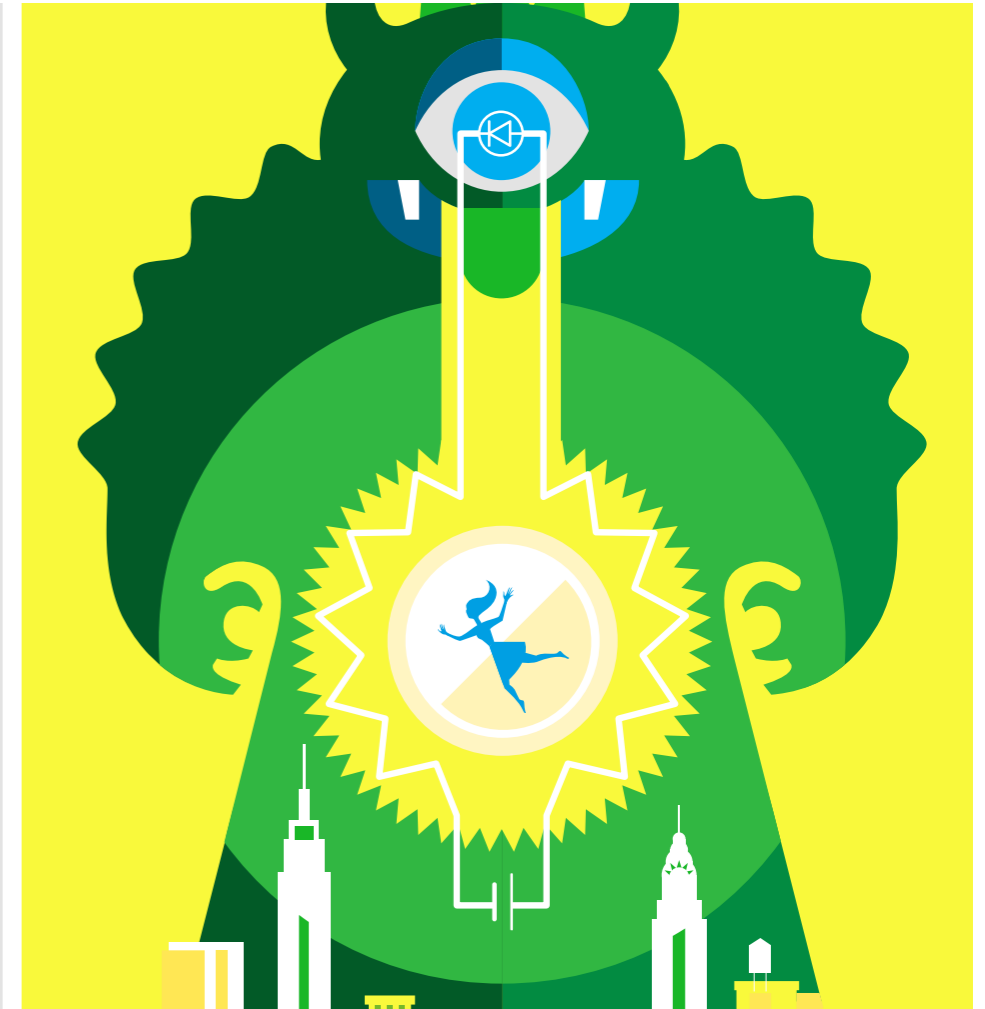
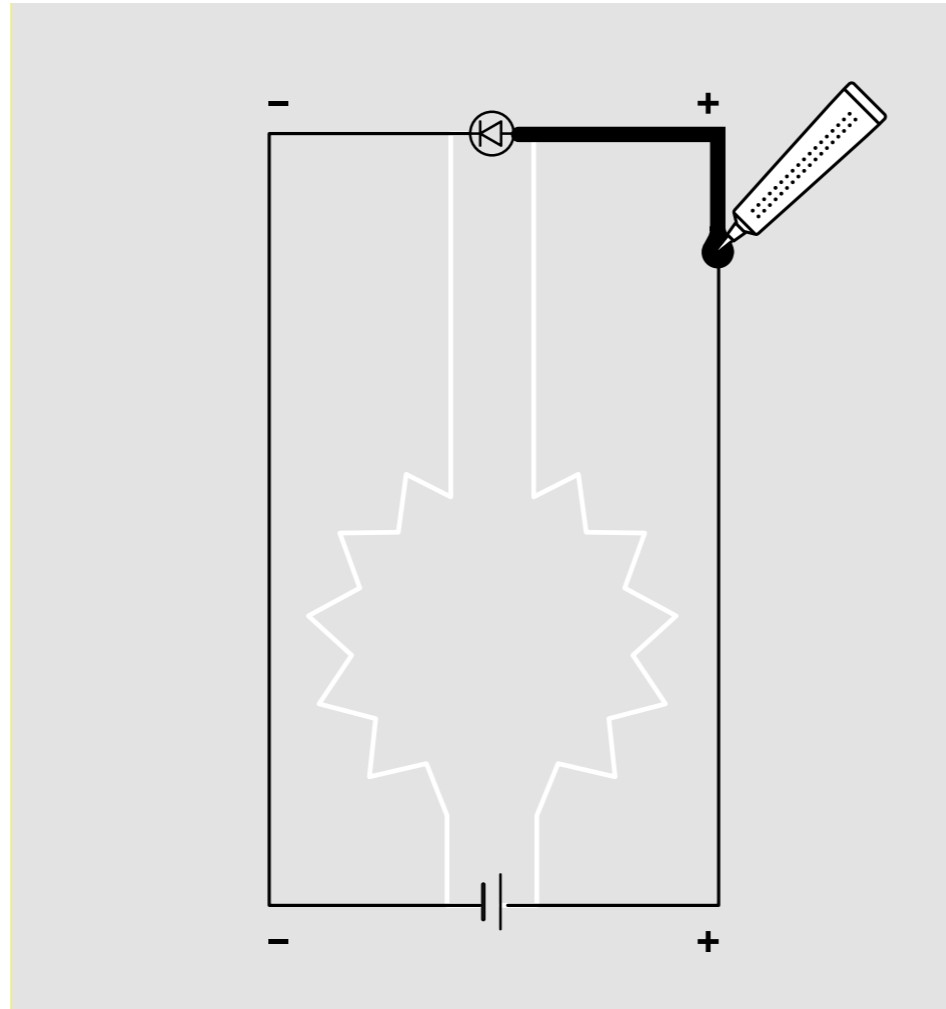
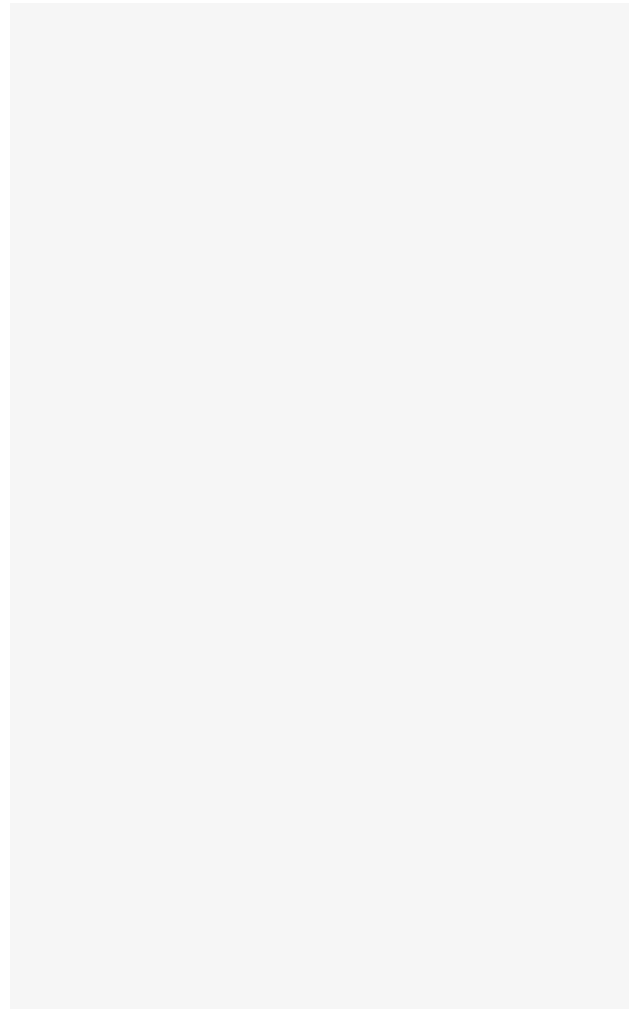

What is a circuit

Understanding and creating circuits with Electric Paint

Your circuits don't have to include straight lines or look conventional. With Electric Paint you can write a word or draw a picture to turn conductive pathways into graphics.

An electrical circuit is a pathway that begins and ends in the same place, passing electricity through it. In a basic circuit there will be components that put this electricity to use as power passes to each component or device.

To be able to flow, electricity needs a conductive material as its pathway. Electric Paint is conductive, so it can provide this. How does it start moving in the first place? Electricity flows from a higher voltage (positive

+) to a lower voltage (negative -). Batteries and some components will have a positive and negative connection (they exhibit **polarity***) so it's important to position them the right way round for electricity to flow through the circuit.

***Polarity** — Electricity flows from a higher voltage to a lower voltage. In a direct current (DC) circuit, the current flows in one direction only.

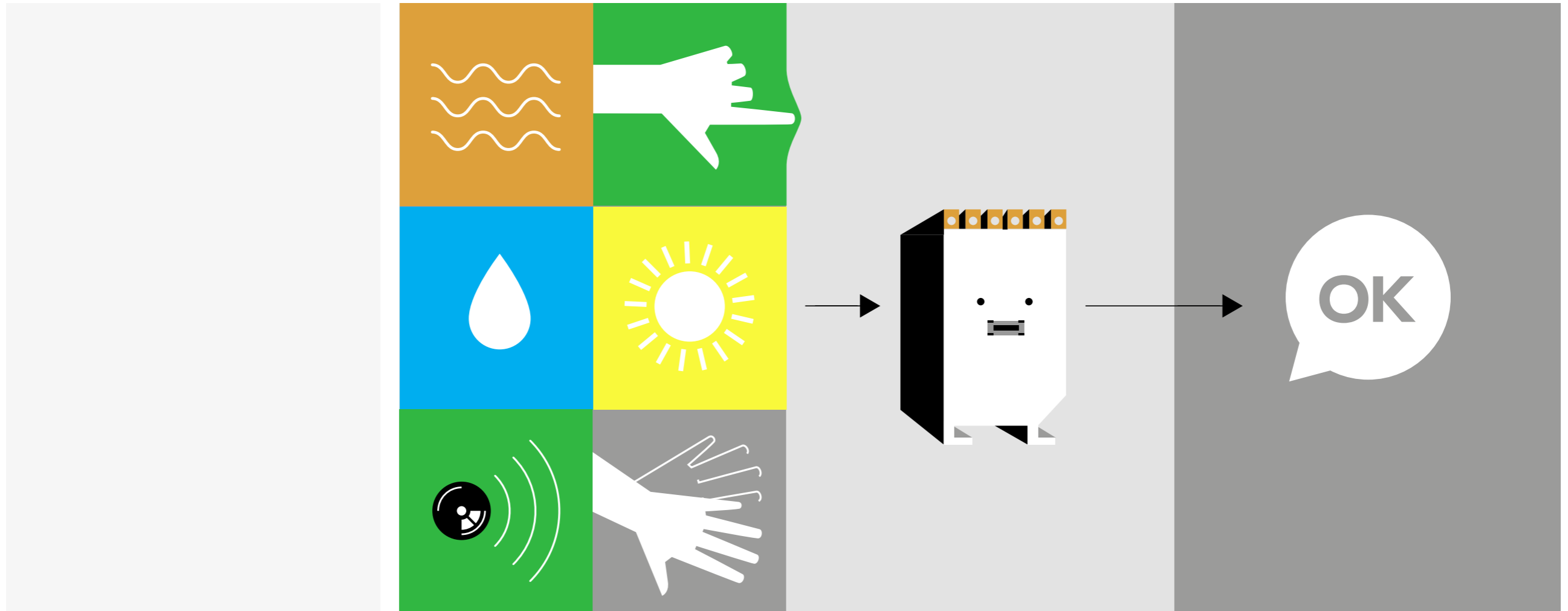

INPUT

PROCESS

OUTPUT

What is a sensor

Understanding different types of sensors

Sensors are hidden everywhere around us, like in fire alarms, security lights or automatic doors in shops.



In the broadest definition, a sensor is an object whose purpose is to detect changes in its environment, which could be light, pressure, touch, heat, sound, moisture, and motion among other things. The sensor then provides an output that we can detect electronically. For example, a light sensor could detect the sun rising and trigger a system to open the blinds in a bedroom.

The Touch Board has 12 sensors that can detect changes in capacitance caused by touch or proximity (distance). So it can translate touch or distance into any output defined by you.

Each Touch Board electrode generates a sensitive electric field.

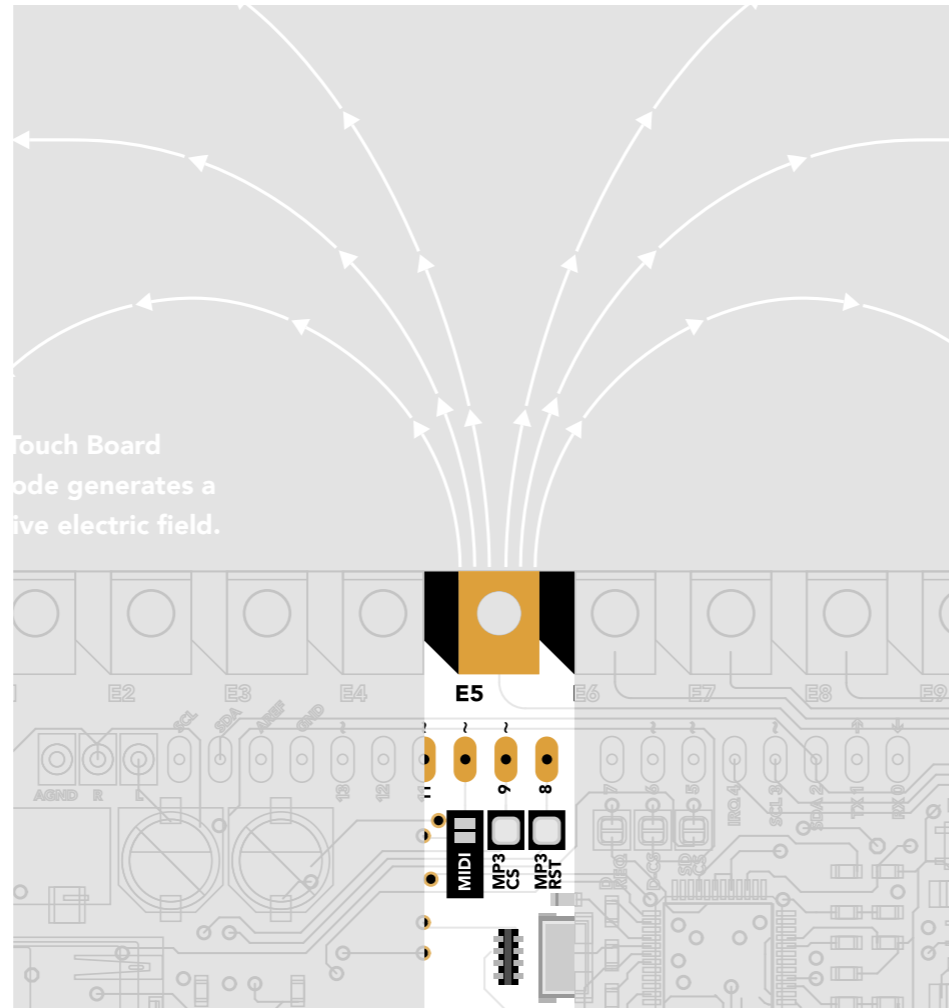

Your finger couples with the electrode's field and connects it to earth, which the Touch Board can detect.



What is capacitive sensing

This is how the Touch Board works, but what does it really mean?

Touch screens on your smart phone or tablet, or the trackpad on your laptop also work with capacitive sensing.



Capacitive sensing is a proximity sensing technology. It detects nearby objects by sensing that the electric field generated by a sensor (in this case one of the 12 electrodes), has been disrupted. It can detect anything that is conductive or that has a significantly different **permittivity*** than that of air, like a human body or hand.

Capacitive sensing is the technology used in smart-phone screens to detect touch. It's also used in other situations where there's a need to detect human touch or proximity.

It's also used when trying to detect something without touching it.

The Touch Board has 12 capacitive sensing electrodes, each of which can individually detect touch and proximity.

***Permittivity** [put-mi-tiv-i-tee] is the measure of the difficulty encountered when forming an electric field in a material. The ability of a substance to store electrical energy in an electric field.

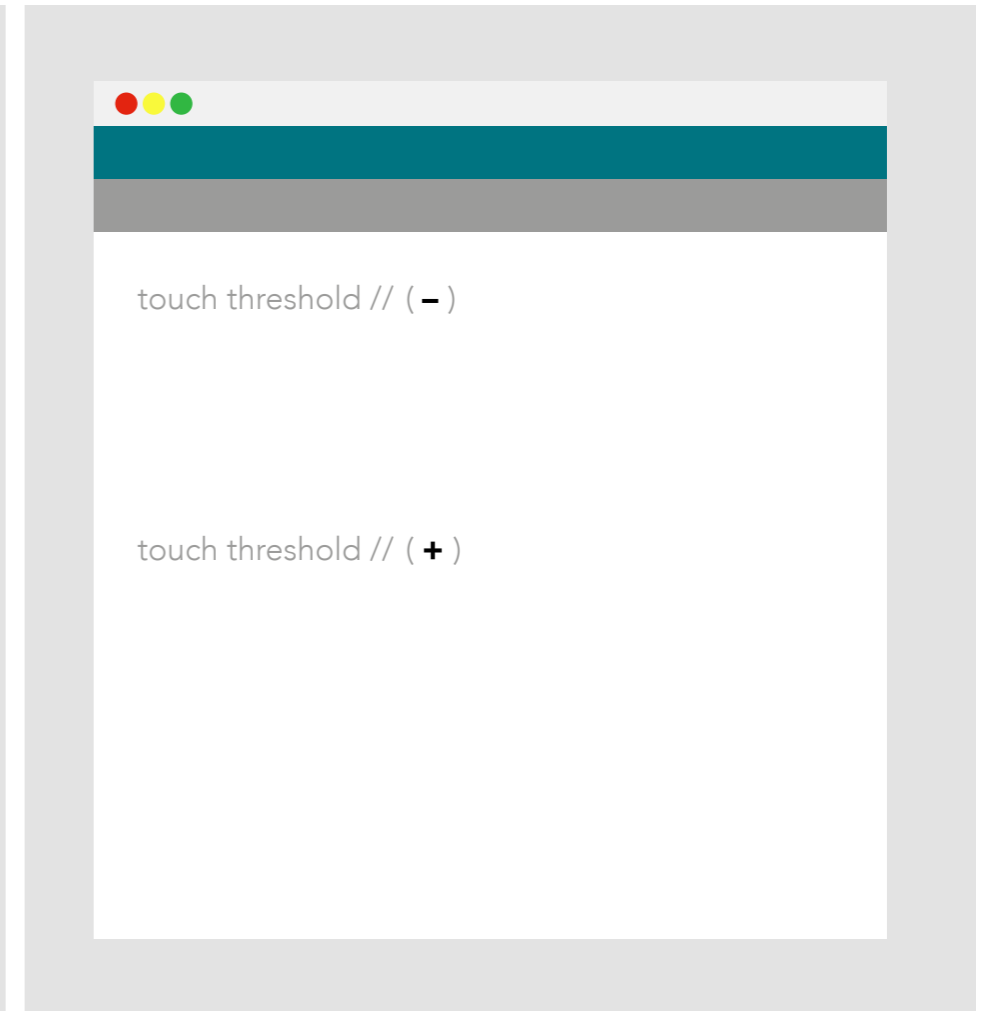
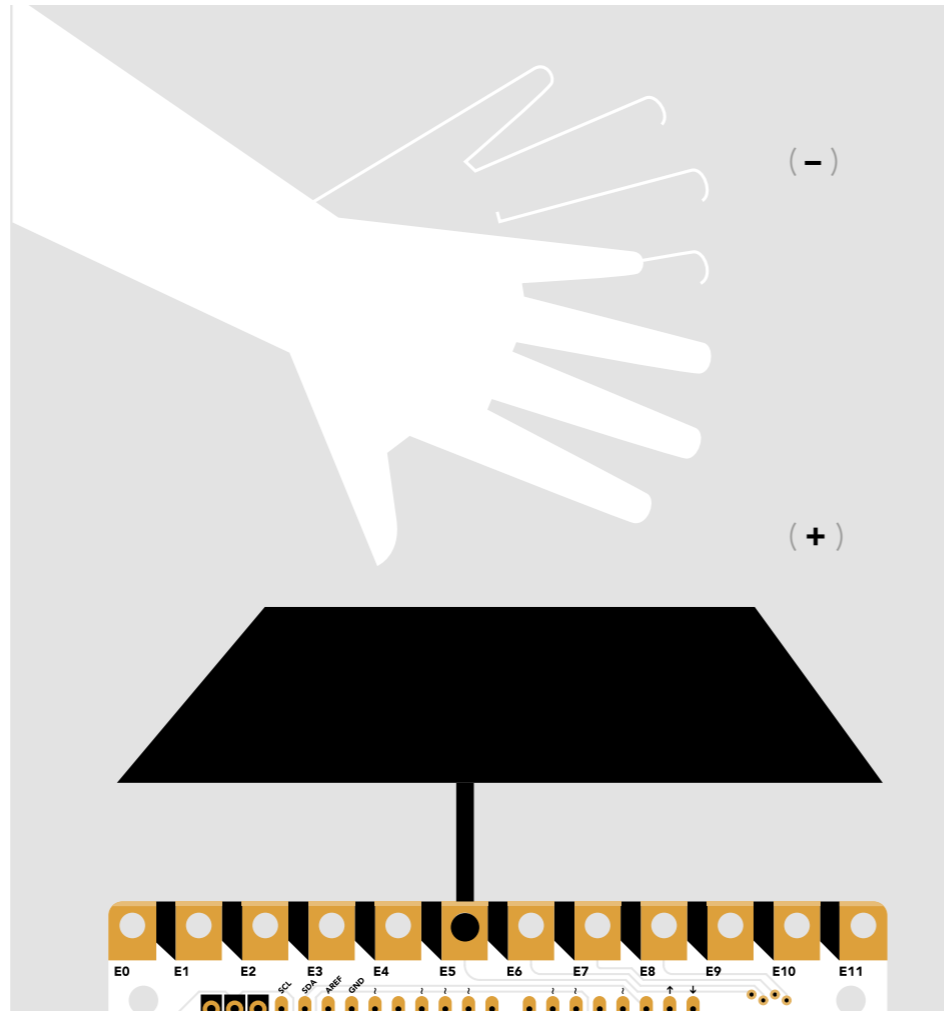

What is distance sensing

The Touch Board can work without touch too. Try distance sensing (proximity)

Although it's called the Touch Board, what the electrodes are really doing is sensing proximity via capacitive sensing. When you set a sensor's thresholds to be relatively high, the Touch Board only responds to actual contact or touch, rejecting proximity events.

If you want the Touch Board to sense something from further away, or even through an insulation such as

glass or plastic, you can lower each sensor's threshold to increase sensitivity — turning the Touch Board into a 'Proximity Board'.

If you would like to change the sensitivity of one or more of the electrodes on your board, just follow the proximity tutorial on the [bareconductive.com](https://www.bareconductive.com) website.

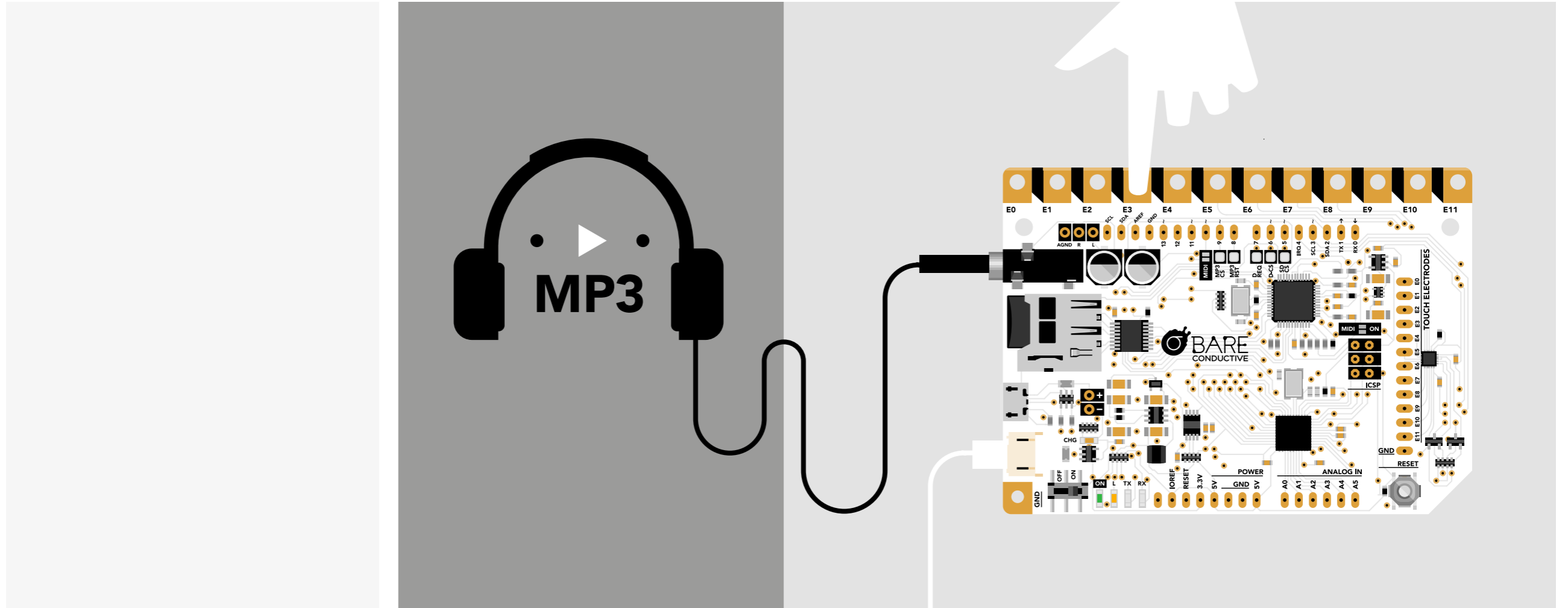

What is touch MP3

Listen to the Audio Guide, then load your own MP3 tracks

When in touch MP3 mode, the Touch Board works just like an MP3 player. Instead of using a screen to make the sound play, the board allows you to create your own interfaces on any surface you want.

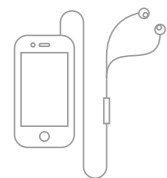

The Touch Board comes preprogrammed as an MP3 player complete with a micro SD card. This means that you can use it to trigger up to 12 MP3 tracks via touch, with no programming required.

Changing the sounds on your board when it's on MP3 mode is easy. Just remove the SD card from the board and put it into a SD card reader, then slot this into your computer. It's just like loading files onto a USB stick. You can drag and drop your MP3 files onto the SD card, but

they must be named with the advised standard to work correctly.

Just like an MP3 player, each sound or song on the Touch Board plays one-at-a-time when you touch an electrode — you can't play multiple sounds at once. If you are interested in multiple simultaneous sounds (also known as polyphonic playback) take a look at the onboard MIDI section of this manual.

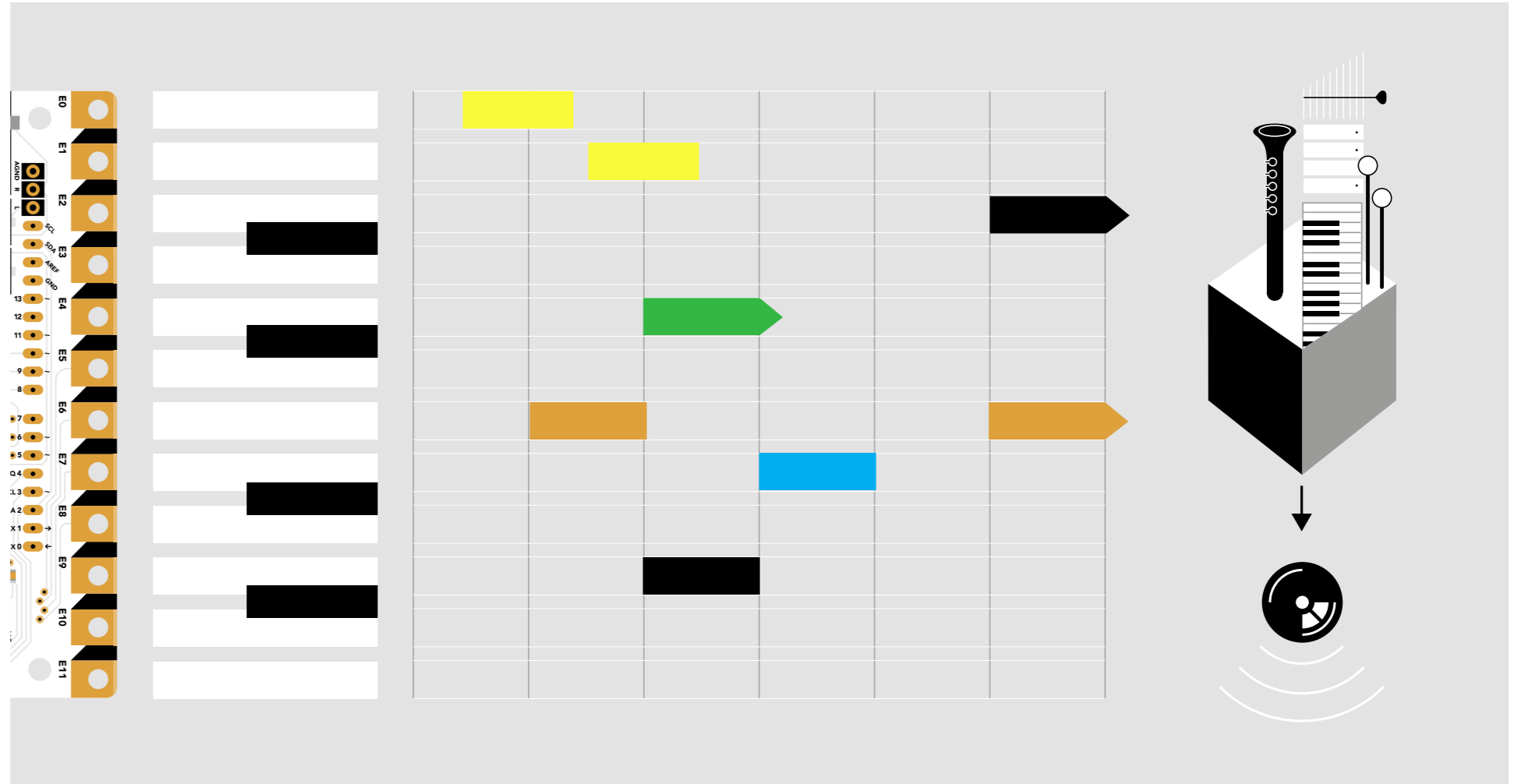

What is MIDI

MIDI is an acronym for Musical Instrument Digital Interface

Some of the more famous MIDI instruments include the early Roland synthesizers from the 1980's.

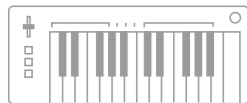

MIDI is a standard that describes communication between electronic musical instruments and computers. The advantages of MIDI include the ability to modify notes as they play and to quickly change between instrument sounds.

The Touch Board has an audio processor that we normally use to play back MP3s. However, with a few easy modifications to the board, it can play back audio from MIDI data using its inbuilt synthesiser. Unlike touch MP3 mode, this allows us to choose from a bank of instruments and play back several notes simultaneously. You can turn

the Touch Board into a piano, drum kit or even a clarinet if you want to.

The Touch Board can also be connected to a computer via USB to control music programs such as Ableton Live or Garage Band. These programs do the synthesis for us, enabling more sophisticated outputs. In addition to notes, this also allows us to pass proximity data as MIDI "control change" messages — a bit like turning a control knob or moving a fader up and down. When using the Touch Board, this means you can create sophisticated custom instrument to your own design.

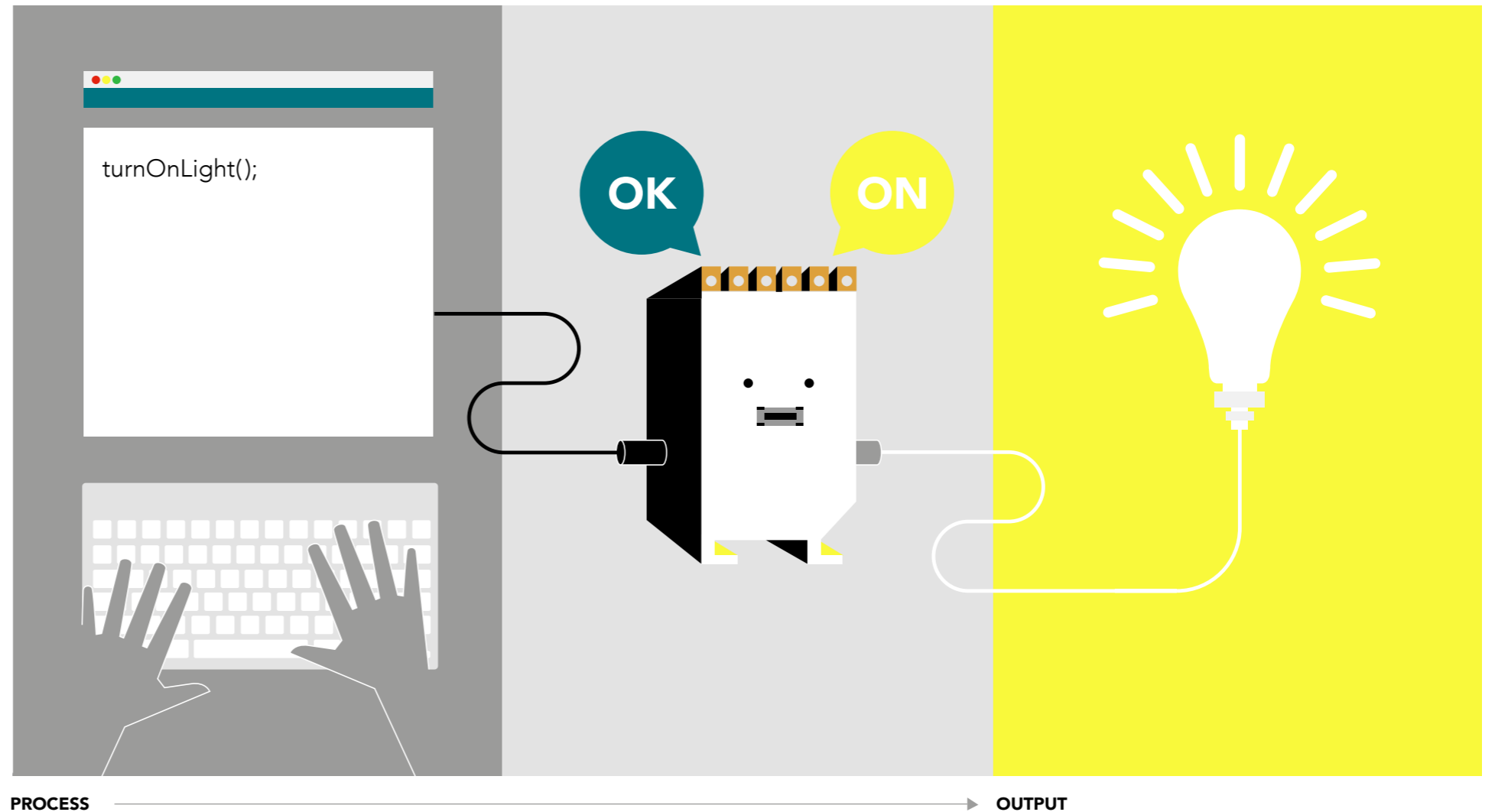

What is programming

Understanding code and what it does



GitHub is a platform that allows its users to talk about and share code with friends, classmates and even complete strangers.

You can find many example codes for the Touch Board at:

<https://github.com/BareConductive>

Just like sensors, code is hidden all around us. In fact, it's code that gives sensors instructions on what to do when they detect an input. Every smart phone, website, computer, microwave or computer game needs code to make it work.

Programming is the act of creating code. It involves typing commands to a computer to tell it exactly what to do.

There are many computer languages used for programming. The Touch Board uses the Arduino*

Integrated Development Environment (Arduino IDE). The IDE works with any Arduino-compatible board, and allows you to write your code in a text box, which is then uploaded to your board to tell it what to do. The advantage of Arduino is that it benefits from a large community of users who share code to help build on each others projects.

***Arduino** is a platform that make easy to use software and hardware for creating interactive projects. The Touch Board works with Arduino software.
<https://www.arduino.cc/>

Electric Paint

Drying time

Don't waste time watching paint dry. Structure your workshop so those 15 minutes of drying time are used productively!

How much paint is in the 10ml tube?

One tube of Electric Paint can draw a 19 metre long line. Use this to calculate how much paint you will need for the session.

How much paint is in the 50ml jar?

Allow one 50ml jar of Electric Paint for screen printing an area of about one square metre. If you are using a brush, bear in mind the surface will be thicker than if screen printing, so you might use more paint.

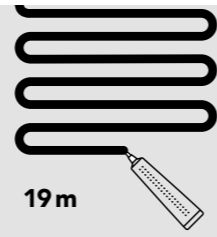

1m²



TOUCH BOARDS

We advise a maximum of three people per Touch Board. It may be helpful to outline an area of responsibility to each participant, so that there is a good focus on the outcome.

— **Assign four electrodes per person**



SPACE

Space is important to allow participants to achieve their workshop goal. Depending on the scale of what you'll be making this will change, but we generally advise one square metre per person. — **1 square metre of space per person**

1m²



POWER

Access to power is paramount. Each Touch Board can be powered via USB connection to a PC or through a USB mains plug. If participants are using laptops and Touch Boards, each device will need at least one power socket.

— **Get multiple USB leads, or a USB hub**



PROJECT THEME

Depending on the age group or level of participants, the workshop plan can vary. For beginners, a simple touch MP3 project may be enough, for more advanced participants assigning a few words as a theme may be a simple but broad enough brief. — **'Game controllers' could be a stronger theme than 'sensors' alone**

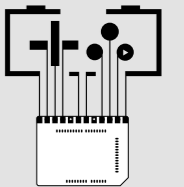

DEMONSTRATE

Nothing beats seeing something in the flesh to understand how it works. Take the time to assemble an engaging demonstration for your participants to look at.

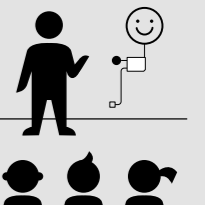

SENSOR DESIGN

Not all sensors will behave the same. Shape, size, and form can affect their functionality, so make sure to highlight these limitations to set participants up for success. Hand-sized sensors work well in most conditions — the larger the sensor, the more tricky to work with.

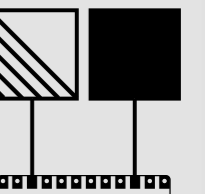

DOCUMENT

Taking the time to document your process is extremely rewarding. Use photos as visual note taking, to reflect on your process, and to share with others. Send Bare Conductive your photos for a chance to be featured on the website.

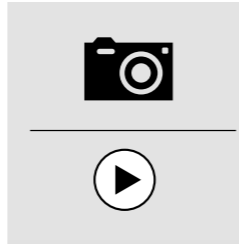

CLEAN UP

If your workshop is going well there will be paint everywhere. Good preparation means you won't have to worry about the mess. Cover tables with paper, provide aprons and lots of wet wipes. Electric Paint is water soluble so there's no risk of permanent damage to clothes or furniture. — **Wet wipes will make the clean-up easier**

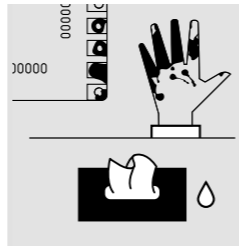

Troubleshooting

SHORT CIRCUIT

A short circuit is where electrical current passes down an unintended path from one point to another, potentially causing damage to the circuit.

When the Touch Board is turned on, it's important to place it on a non-conductive surface. Make sure it's not lying on a metal table, conductive foam or the sensor you have just

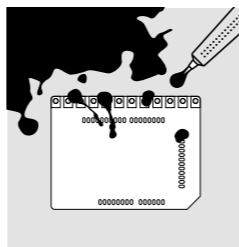

painted with Electric Paint. If any of these are the case, you may short circuit it. — **Make sure not to bridge two adjacent electrodes with the paint, otherwise the Touch Board will not function correctly.**

LOADING MP3S

Ensure that the MP3 files are labelled correctly. If you are using the Touch_MP3 code the tracks should be labelled: TRACK000.MP3 to TACK011.MP3, which correspond to the electrodes E0 – E11.



EDITING MP3S

When creating your own MP3 files makes sure you edit them to end when the music stops and/or clip out any dead time before the beginning of the track. If this is not done it can often seem like the Touch Board is responding slowly, when in fact the track is playing the silence before the music. Files must also be saved in MP3 format — a WAV or WMA file simply renamed as an MP3 will not play correctly.

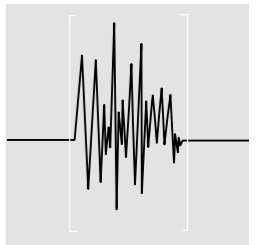

SENSOR SIZE

When designing painted sensors to attached to the Touch Board there is a basic rule of thumb that can help. The size of the trigger (i.e. your hand or finger) should be relatively large in comparison to the sensor. By hatching the sensor, instead of filling in the whole shape, you keep the amount of conductive matter low in comparison to the trigger but at the same time keeping the sensing area large.

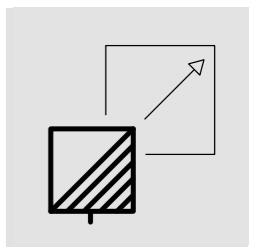

SHOPPING LIST

Essentials

- Touch Boards
- Electric Paint 10ml Tubes
- Electric Paint 50ml Jars
- Alligator clips
- Mini speakers
- Micro USB cables / Power

Good to have

- Headphones — could replace mini speakers
- Wet wipes — to clean Electric Paint off Touch Boards
- Blue-tac — handy for keeping Touch Boards in place
- Plastic tarps — for covering tables if painting
- Scissors and cutters
- Masking tape — in variety of widths
- Polypropylene sheet — A3 or larger
- Paint and stencil brushes or foam rollers

Documenting your work

SPACE



Try to capture the great work being created, rather than the people making it. Covering work tables with large sheets of white paper ensures you have clean environment as your backdrop for your photos.

PROCESS



Shoot on light backgrounds to make elements stand out. Focus on what and how it's being made.

INTERACTION



Try shooting hands interacting with the project instead of the person. It allows the viewer to concentrate on what was made rather than a pretty face.

FINAL PROJECT



It's great to see a project finished and working. Try to display it on a light backdrop (a simple roll of white paper works very well). Do your best to remove anything that is not related to the project from the frame.



The top part of this image shows people working together, but unfortunately the focus is on the cup in the foreground. Make sure the camera focuses on the important stuff.



This image would have been great if the photographer framed it towards the project.



This would be a great picture but unfortunately the Touch Board got detached from the project.



This image is too dark. ensure your camera is set correctly to the space you're photographing in. Although some image can be lightened through software, it's always best to do it right the first time.

MINI / 45 minutes

A workshop template for those with a small amount of time

INTRO / 5 minutes

“Hello”, introduction to Electric Paint and Touch Board, a general overview of the technology.

DEMO + BRIEF / 10 minutes

Present a working demo of the project to get the group excited. Explain how it was made and how it works. Encourage following your example, and explain what you would like the participants to focus on.

DESIGN + MAKE / 10 minutes

Split the group into groups of 2 or 3 and get them started. If using Electric Paint make sure each group starts painting first so it's dry and working by the end of the session.

EXPAND + TEST / 10 minutes

Once the participants have got making, keep a little time for troubleshooting and exploring. This could mean adding more sounds if using the Touch Board, or even decorating.

COMPLETE + PRESENT / 10 minutes

In the last 10 minutes the group should add the finishing touches to their project and then have a quick discussion about what they learned with the rest of their team.

DOCUMENT

Don't forget to take pictures. Send them in for a chance to be featured on the **MAKE** page. Email info@bareconductive.com

BASIC / 1.5 hours

A template for quick projects or with Touch Board beginners

INTRO / 5 minutes

“Hello”, introduction to Electric Paint and the Touch Board, general overview of the technology.

DEMO / 10 minutes

Present a working demo of the project to get the group excited. Explain how it was made and how it works. Encourage following your example, and explain what you would like the participants to focus on.

EXPERIMENT / 15 minutes

Allow the group to play with your demo and explore the tools and materials which you used to make it.

BRIEF + ORGANISE / 10 minutes

Now that the participants have a clear understanding of how the technology works, present them with their brief.

Split the participants into groups of 2 or 3 and direct them to the prepared spaces for them to start working.

BUILD PROJECT / 40 minutes

Guide the groups through the project step-by-step instructions and worksheet. Once they start working, keep them updated with how much time they have remaining at regular intervals.

SHARE / 10 minutes

Allow each group to share and present their project. It will be interesting for each group to see how the same brief can look so different depending on the author.

DOCUMENT

Don't forget to take pictures. Send them in for a chance to be featured on the **MAKE** page. Email info@bareconductive.com

HALF DAY / 4 hours

Expand the Basic workshop or create a wider brief

INTRO + DEMO / 30 minutes

“Hello, these are the great projects you can make.”

Set the context of the technology. Present a working demo of the project to get the group excited. Then introduce the Touch Board and Electric Paint to explain how the project is made.

EXPERIMENT / 15 minutes

Allow the group to play with your demo and explore the tools and materials.

ORGANISE / 10 – 15 minutes

Split the participants into groups of 2 or 3 and direct them to the prepared spaces so they can start working. If the age group is 15+ you can encourage short intros or allow the group to organise themselves.

MINI PROJECT / 20 minutes

A mini brief to get their feet wet. This could be based on making one of the Basic projects.

Example: Make a MIDI instrument

HACK THE MINI PROJECT / 5 minutes

Make sure everyone got it working, then encourage the groups to rethink the audio and interface to create a new story based on the same technology.

PROJECT BRAINSTORM / 10 minutes

Facilitate idea generation through sketches or making.

PROTOTYPE / 30 minutes

Each group should make a quick and dirty prototype to make sure they understand how to make everything work. This exercise can be based on one of the projects from the Basics section, or you can create your own.

BUILD PROJECT / 1.5 hours

Groups make final project from scratch, or make a significant hack to the basic project from the mini brief.

SHARE / 20 minutes

Allow each group to share their project with others.

DOCUMENT

Don't forget to take pictures. Send them in for a chance to be featured on the **MAKE** page. Email info@bareconductive.com

FULL DAY / 8 hours

Use a whole day to make outstanding projects

INTRO + DEMO / 30 minutes

“Hello, these are the great projects you can make.”

Set the context and tell a story. Present a working demo of the project to get the group excited. Then introduce the Touch Board and Electric Paint to explain how the project is made.

EXPERIMENT / 15 minutes

Allow the group to play with your demo and explore the tools and materials.

ORGANISE / 10 – 15 minutes

Split the participants into groups of 2 or 3 and direct them to the prepared spaces so they can start working. If the age group is 15+ you can encourage short intros or allow the group to organise themselves.

MINI PROJECT / 20 minutes

A mini brief to get their feet wet. This could be based on making one of the Basic projects.

Example: Make a MIDI instrument

HACK THE MINI PROJECT / BRIEF / 5 minutes

Make sure everyone got it working, then encourage the groups to rethink the audio and interface to create a new story based on the same technology.

Example: Change the MIDI instrument into a Spaceship control panel.

BRAINSTORM / 45 minutes

Facilitate idea generation through sketches or making.

PROTOTYPE / 30 minutes

Encourage the participants to prototype before making their final project. Making small tests and iterations of the ideas will make them stronger in the final build. Special attention should be paid to scaling projects and testing large sensors before making lots of them.

BUILD PROJECT / 4 hours

Groups make final project from scratch, or make a significant hack to the basic project from the mini brief.

SHARE / 30 minutes

Allow each group to share their project with others.

DOCUMENT

Don't forget to take pictures. Send them in for a chance to be featured on the **MAKE** page. Email info@bareconductive.com

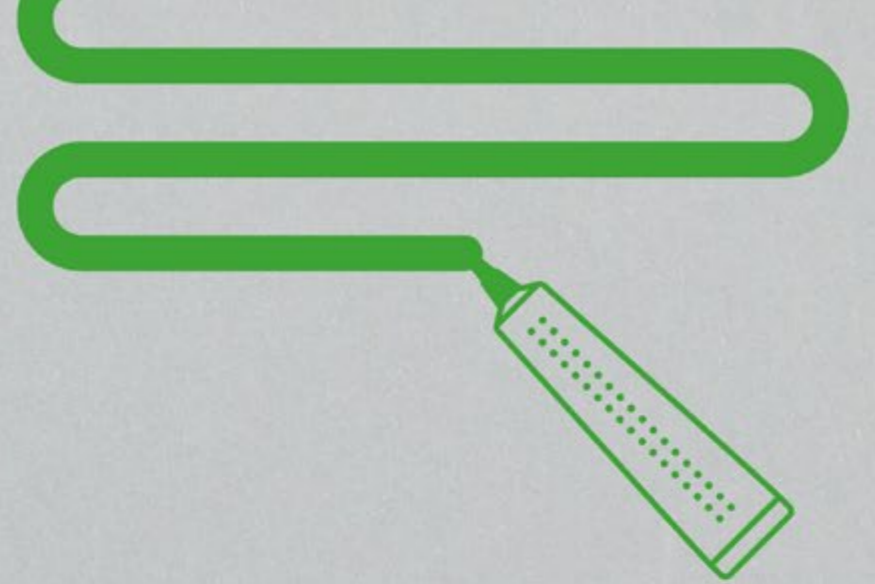

bareconductive.com

@bareconductive | #ElectricPaint | #TouchBoard

