



**User Manual**

# PCM-9562

**ADVANTECH**

*Enabling an Intelligent Planet*

---

## Copyright

The documentation and the software included with this product are copyrighted 2010 by Advantech Co., Ltd. All rights are reserved. Advantech Co., Ltd. reserves the right to make improvements in the products described in this manual at any time without notice. No part of this manual may be reproduced, copied, translated or transmitted in any form or by any means without the prior written permission of Advantech Co., Ltd. Information provided in this manual is intended to be accurate and reliable. However, Advantech Co., Ltd. assumes no responsibility for its use, nor for any infringements of the rights of third parties, which may result from its use.

## Acknowledgements

Award is a trademark of Award Software International, Inc.

VIA is a trademark of VIA Technologies, Inc.

IBM, PC/AT, PS/2 and VGA are trademarks of International Business Machines Corporation.

Intel and Pentium are trademarks of Intel Corporation.

Microsoft Windows is a registered trademark of Microsoft Corp.

RTL is a trademark of Realtek Semi-Conductor Co., Ltd.

ESS is a trademark of ESS Technology, Inc.

UMC is a trademark of United Microelectronics Corporation.

SMI is a trademark of Silicon Motion, Inc.

Creative is a trademark of Creative Technology LTD.

CHRONTEL is a trademark of Chrontel Inc.

All other product names or trademarks are properties of their respective owners.

## Product Warranty (2 years)

Advantech warrants to you, the original purchaser, that each of its products will be free from defects in materials and workmanship for two years from the date of purchase.

This warranty does not apply to any products which have been repaired or altered by persons other than repair personnel authorized by Advantech, or which have been subject to misuse, abuse, accident or improper installation. Advantech assumes no liability under the terms of this warranty as a consequence of such events.

Because of Advantech's high quality-control standards and rigorous testing, most of our customers never need to use our repair service. If an Advantech product is defective, it will be repaired or replaced at no charge during the warranty period. For out-of-warranty repairs, you will be billed according to the cost of replacement materials, service time and freight. Please consult your dealer for more details.

If you think you have a defective product, follow these steps:

1. Collect all the information about the problem encountered. (For example, CPU speed, Advantech products used, other hardware and software used, etc.) Note anything abnormal and list any onscreen messages you get when the problem occurs.
2. Call your dealer and describe the problem. Please have your manual, product, and any helpful information readily available.
3. If your product is diagnosed as defective, obtain an RMA (return merchandise authorization) number from your dealer. This allows us to process your return more quickly.
4. Carefully pack the defective product, a fully-completed Repair and Replacement Order Card and a photocopy proof of purchase date (such as your sales receipt) in a shippable container. A product returned without proof of the purchase date is not eligible for warranty service.
5. Write the RMA number visibly on the outside of the package and ship it prepaid to your dealer.

## Declaration of Conformity

### FCC Class B

This equipment has been tested and found to comply with the limits for a Class B digital device, pursuant to part 15 of the FCC Rules. These limits are designed to provide reasonable protection against harmful interference in a residential installation. This equipment generates, uses and can radiate radio frequency energy and, if not installed and used in accordance with the instructions, may cause harmful interference to radio communications. However, there is no guarantee that interference will not occur in a particular installation. If this equipment does cause harmful interference to radio or television reception, which can be determined by turning the equipment off and on, the user is encouraged to try to correct the interference by one or more of the following measures:

- Reorient or relocate the receiving antenna.
- Increase the separation between the equipment and receiver.
- Connect the equipment into an outlet on a circuit different from that to which the receiver is connected.
- Consult the dealer or an experienced radio/TV technician for help.

---

## Technical Support and Assistance

1. Visit the Advantech web site at [www.advantech.com/support](http://www.advantech.com/support) where you can find the latest information about the product.
2. Contact your distributor, sales representative, or Advantech's customer service center for technical support if you need additional assistance. Please have the following information ready before you call:
  - Product name and serial number
  - Description of your peripheral attachments
  - Description of your software (operating system, version, application software, etc.)
  - A complete description of the problem
  - The exact wording of any error messages

## Warnings, Cautions and Notes

**Warning!** *Warnings indicate conditions, which if not observed, can cause personal injury!*



**Caution!** *Cautions are included to help you avoid damaging hardware or losing data. e.g.*



*There is a danger of a new battery exploding if it is incorrectly installed. Do not attempt to recharge, force open, or heat the battery. Replace the battery only with the same or equivalent type recommended by the manufacturer. Discard used batteries according to the manufacturer's instructions.*

**Note!** *Notes provide optional additional information.*



## Document Feedback

To assist us in making improvements to this manual, we would welcome comments and constructive criticism. Please send all such - in writing to: [support@advantech.com](mailto:support@advantech.com)

## Packing List

Before setting up the system, check that the items listed below are included and in good condition. If any item does not accord with the table, please contact your dealer immediately.

- |                        |            |
|------------------------|------------|
| ■ 1 x PCM-9562 SBC     |            |
| ■ 1 x Startup manual   |            |
| ■ 1 x Utility CD       |            |
| ■ 1 x ATX 5VSB CABLE   | 1700015741 |
| ■ 1 x mini jumper pack | 9689000002 |

## Ordering Information

### Model Number Description

PCM-9562D-S6A1E	D510+ICH8M 2GbE/5COM/3SATAII/CFII/M-PCIe
PCM-9562N-S6A1E	N450+ICH8M 2GbE/5COM/3SATAII/CFII/M-PCIe
PCM-9562DF-S6A1E	D510+ICH8M 3GbE/6COM/3SATAII/CFII/M-PCIe
PCM-9562NF-S6A1E	N450+ICH8M 3GbE/6COM/3SATAII/CFII/M-PCIe

Model	CPU	Memory	LVDS	GbE	GbE3 UL60601	WDT	HD Audio	USB2.0	RS-232	RS-422/485	PC-104+	Mini-PCIe	Thermal	Operating Temperature
PCM-9562N-S6A1E	N450	SO_DIMM	18-bit	2	-	1	HD	8	3	2	Yes	1	Passive	0-60°C
PCM-9562D-S6A1E	D510	SO_DIMM	18-bit	2	-	1	HD	8	3	2	Yes	1	Active	0-60°C
PCM-9562NF-S6A1E	N450	SO_DIMM	18-bit	2	1	2	HD	8	3+1	2	Yes	1	Passive	0-60°C
PCM-9562DF-S6A1E	D510	SO_DIMM	18-bit	2	1	2	HD	8	3+1	2	Yes	1	Active	0-60°C
PCM-9562NZ-1GS6A1E	N450	Bundle 1GB	18-bit	2	Optional	1	HD	8	3	2	Yes	1	Passive	-20-80°C
PCM-9562ZZ-1GS6A1E	N450	Bundle 1GB	18-bit	2	Optional	1	HD	8	3	2	Yes	1	Passive	-40-85°C

## Optional Accessories

### Part Number

PCM-10586-9562E  
 PCM-110-00A3E  
 PCM-120-00A3E  
 PCM-200-00A2E  
 CF-HDD-ADP  
 1960049954N001

### Description

Wiring kit for PCM-9562 Series  
 1-slot PCI riser card for 5.25" biscuits  
 2-slot PCI riser card for 5.25" biscuits  
 PC/104-Plus to PCI bus module  
 CompactFlash 50-pin to IDE 44-pin adapter  
 Hearspreader 157.4 x 100 x 24 mm

---

## Safety Instructions

1. Read these safety instructions carefully.
2. Keep this User Manual for later reference.
3. Disconnect this equipment from any AC outlet before cleaning. Use a damp cloth. Do not use liquid or spray detergents for cleaning.
4. For plug-in equipment, the power outlet socket must be located near the equipment and must be easily accessible.
5. Keep this equipment away from humidity.
6. Put this equipment on a reliable surface during installation. Dropping it or letting it fall may cause damage.
7. The openings on the enclosure are for air convection. Protect the equipment from overheating. **DO NOT COVER THE OPENINGS.**
8. Make sure the voltage of the power source is correct before connecting the equipment to the power outlet.
9. Position the power cord so that people cannot step on it. Do not place anything over the power cord.
10. All cautions and warnings on the equipment should be noted.
11. If the equipment is not used for a long time, disconnect it from the power source to avoid damage by transient overvoltage.
12. Never pour any liquid into an opening. This may cause fire or electrical shock.
13. Never open the equipment. For safety reasons, the equipment should be opened only by qualified service personnel.
14. If one of the following situations arises, get the equipment checked by service personnel:
  - The power cord or plug is damaged.
  - Liquid has penetrated into the equipment.
  - The equipment has been exposed to moisture.
  - The equipment does not work well, or you cannot get it to work according to the user's manual.
  - The equipment has been dropped and damaged.
  - The equipment has obvious signs of breakage.
15. **DO NOT LEAVE THIS EQUIPMENT IN AN ENVIRONMENT WHERE THE STORAGE TEMPERATURE MAY GO BELOW -20° C (-4° F) OR ABOVE 60° C (140° F). THIS COULD DAMAGE THE EQUIPMENT. THE EQUIPMENT SHOULD BE IN A CONTROLLED ENVIRONMENT.**
16. **CAUTION: DANGER OF EXPLOSION IF BATTERY IS INCORRECTLY REPLACED. REPLACE ONLY WITH THE SAME OR EQUIVALENT TYPE RECOMMENDED BY THE MANUFACTURER, DISCARD USED BATTERIES ACCORDING TO THE MANUFACTURER'S INSTRUCTIONS.**

The sound pressure level at the operator's position according to IEC 704-1:1982 is no more than 70 dB (A).

**DISCLAIMER:** This set of instructions is given according to IEC 704-1. Advantech disclaims all responsibility for the accuracy of any statements contained herein.

## Wichtige Sicherheitshinweise

1. Bitte lesen sie Sich diese Hinweise sorgfältig durch.
2. Heben Sie diese Anleitung für den späteren Gebrauch auf.
3. Vor jedem Reinigen ist das Gerät vom Stromnetz zu trennen. Verwenden Sie Keine Flüssig-oder Aerosolreiniger. Am besten dient ein angefeuchtetes Tuch zur Reinigung.
4. Die Netzanschlussteckdose soll nahe dem Gerät angebracht und leicht zugänglich sein.
5. Das Gerät ist vor Feuchtigkeit zu schützen.
6. Bei der Aufstellung des Gerätes ist auf sicheren Stand zu achten. Ein Kippen oder Fallen könnte Verletzungen hervorrufen.
7. Die Belüftungsöffnungen dienen zur Luftzirkulation die das Gerät vor überhitzung schützt. Sorgen Sie dafür, daß diese Öffnungen nicht abgedeckt werden.
8. Beachten Sie beim. Anschluß an das Stromnetz die Anschlußwerte.
9. Verlegen Sie die Netzanschlusbleitung so, daß niemand darüber fallen kann. Es sollte auch nichts auf der Leitung abgestellt werden.
10. Alle Hinweise und Warnungen die sich am Geräten befinden sind zu beachten.
11. Wird das Gerät über einen längeren Zeitraum nicht benutzt, sollten Sie es vom Stromnetz trennen. Somit wird im Falle einer Überspannung eine Beschädigung vermieden.
12. Durch die Lüftungsöffnungen dürfen niemals Gegenstände oder Flüssigkeiten in das Gerät gelangen. Dies könnte einen Brand bzw. elektrischen Schlag auslösen.
13. Öffnen Sie niemals das Gerät. Das Gerät darf aus Gründen der elektrischen Sicherheit nur von autorisiertem Servicepersonal geöffnet werden.
14. Wenn folgende Situationen auftreten ist das Gerät vom Stromnetz zu trennen und von einer qualifizierten Servicestelle zu überprüfen:
  15. Netzkabel oder Netzstecker sind beschädigt.
  16. Flüssigkeit ist in das Gerät eingedrungen.
  17. Das Gerät war Feuchtigkeit ausgesetzt.
  18. Wenn das Gerät nicht der Bedienungsanleitung entsprechend funktioniert oder Sie mit Hilfe dieser Anleitung keine Verbesserung erzielen.
  19. Das Gerät ist gefallen und/oder das Gehäuse ist beschädigt.
  20. Wenn das Gerät deutliche Anzeichen eines Defektes aufweist.
21. **VORSICHT:** Explosionsgefahr bei unsachgemäßen Austausch der Batterie.Ersatz nur durch denselben oder einem vom Hersteller empfohlene-mähnlichen Typ. Entsorgung gebrauchter Batterien nach Angaben des Herstellers.
22. **ACHTUNG:** Es besteht die Explosionsgefahr, falls die Batterie auf nicht fachmännische Weise gewechselt wird. Verfangen Sie die Batterie nur gleicher oder entsprechender Type, wie vom Hersteller empfohlen. Entsorgen Sie Batterien nach Anweisung des Herstellers.
23. Der arbeitsplatzbezogene Schalldruckpegel nach DIN 45 635 Teil 1000 beträgt 70dB(A) oder weiger.

Haftungsausschluss: Die Bedienungsanleitungen wurden entsprechend der IEC-704-1 erstellt. Advantech lehnt jegliche Verantwortung für die Richtigkeit der in diesem Zusammenhang getätigten Aussagen ab.

---

## Safety Precaution - Static Electricity

Follow these simple precautions to protect yourself from harm and the products from damage.

- To avoid electrical shock, always disconnect the power from your PC chassis before you work on it. Don't touch any components on the CPU card or other cards while the PC is on.
- Disconnect power before making any configuration changes. The sudden rush of power as you connect a jumper or install a card may damage sensitive electronic components.



# Contents

<b>Chapter 1</b>	<b>General Information .....</b>	<b>1</b>
1.1	Introduction .....	2
1.2	Product Specifications.....	2
1.3	Chipset.....	3
1.3.1	Functional Specifications .....	3
1.3.2	Mechanical Specifications.....	5
1.3.3	Electrical Specifications .....	5
1.3.4	Environmental Specifications.....	6
<b>Chapter 2</b>	<b>Hardware Installation .....</b>	<b>7</b>
2.1	Jumpers .....	8
2.1.1	Jumper List .....	8
2.1.2	Jumper Settings .....	8
2.1.3	Jumper Description .....	9
2.2	Connectors.....	10
2.2.1	Connector List.....	10
2.2.2	Connector Settings .....	11
2.3	Mechanical.....	15
2.3.1	Jumper and Connector Location.....	15
	Figure 2.1 Jumper and Connector Layout (Component Side) ...	15
	Figure 2.2 Jumper and Connector Layout (Solder Side) .....	16
2.3.2	Board Dimensions.....	17
	Figure 2.3 Board Dimension Layout (Component Side) .....	17
	Figure 2.4 Board Dimension Layout (Solder Side) .....	18
<b>Chapter 3</b>	<b>BIOS Settings.....</b>	<b>19</b>
	Figure 3.1 Setup program initial screen .....	20
3.1	Entering Setup .....	20
3.2	Main Setup .....	20
	Figure 3.2 Main setup screen .....	21
3.2.1	System time / System date .....	21
3.3	Advanced BIOS Features Setup .....	21
	Figure 3.3 Advanced BIOS features setup screen .....	22
3.3.1	CPU Configuration .....	22
	Figure 3.4 CPU Configuration Setting .....	22
3.3.2	IDE Configuration.....	23
	Figure 3.5 IDE Configuration .....	23
3.3.3	Floppy Configuration.....	24
	Figure 3.6 Floppy Configuration .....	24
3.3.4	Super I/O Configuration .....	24
	Figure 3.7 Super I/O Configuration.....	24
3.3.5	Hardware Health Configuration.....	25
	Figure 3.8 Hardware health configuration.....	25
3.3.6	ACPI Settings.....	26
	Figure 3.9 ACPI Settings .....	26
	Figure 3.10General ACPI Configuration .....	26
	Figure 3.11Advanced ACPI Configuration.....	27
	Figure 3.12Chipset ACPI Configuration.....	27
3.3.7	AHCI Configuration .....	28
	Figure 3.13Advanced ACPI Configuration.....	28
3.3.8	APM Configuration.....	29

	Figure 3.14 APM Configuration .....	29
3.3.9	Event Log Configuration .....	30
	Figure 3.15 South Bridge ACPI Configuration .....	30
3.3.10	MPS Configuration .....	30
	Figure 3.16 South Bridge ACPI Configuration .....	30
3.3.11	SMBIOS Configuration .....	31
	Figure 3.17 South Bridge ACPI Configuration .....	31
3.3.12	USB Configuration .....	31
	Figure 3.18 South Bridge ACPI Configuration .....	31
	Figure 3.19 USB Mass storage Device Configuration .....	32
3.4	Advanced PCI/PnP Settings .....	32
	Figure 3.20 PCI/PNP Setup (top) .....	33
3.5	Boot Settings .....	34
	Figure 3.21 Boot Setup Utility .....	34
3.5.1	Boot settings Configuration .....	34
	Figure 3.22 Boot Setting Configuration .....	34
3.6	Security Setup .....	35
	Figure 3.23 Password Configuration .....	35
3.7	Advanced Chipset Settings .....	36
	Figure 3.24 Advanced Chipset Settings .....	36
3.7.1	North Bridge Chipset Configuration .....	36
	Figure 3.25 North Bridge Configuration .....	36
	Figure 3.26 Video function configuration .....	37
3.7.2	South Bridge Chipset Configuration .....	38
	Figure 3.27 South Bridge Configuration .....	38
3.8	Exit Option .....	39
	Figure 3.28 Exit Option .....	39
3.8.1	Save Changes and Exit .....	39
3.8.2	Discard Changes and Exit .....	39
3.8.3	Load Optimal Defaults .....	39
3.8.4	Load Fail-Safe Defaults .....	39

## **Chapter 4 Software Introduction & Installation 41**

4.1	S/W Introduction .....	42
4.2	Driver Installation .....	42
	4.2.1 Windows XP Professional .....	42
	4.2.2 Other OS .....	42
4.3	Value-Added Software Services .....	42
	4.3.1 SUSI Introduction .....	42
	4.3.2 Software APIs .....	43
	4.3.3 SUSI Utilities .....	44
	4.3.4 SUSI Installation .....	44
	4.3.5 SUSI Sample Programs .....	46

## **Chapter 5 Extension I/O Installation ..... 53**

## **Appendix A Pin Assignments ..... 55**

## **Appendix B Optional Extras for PCM-9562 A1 .... 77**

B.1	PCM-10586-9562E Cable kit for PCM-9562 A1 .....	78
	Table B.1: PCM-10586-9562E Cable kit for PCM-9562 A1 .....	78

## **Appendix C Prog. GPIO & Watchdog Timer ..... 79**

C.1	Watchdog Timer .....	80
	C.1.1 First Watchdog (SCH3106) .....	80
	C.1.2 Second Watchdog (MAX6369) .....	81
C.2	GPIO Sample Code .....	81

## **Appendix D System Assignments .....93**

D.1	1st MB memory map .....	94
	Table D.1: 1st MB memory map .....	94
D.2	DMA channel assignments .....	94
	Table D.2: DMA channel assignments .....	94
D.3	Interrupt assignments.....	94
	Table D.3: Interrupt assignments .....	94
	Table D.4: System I/O Ports .....	95



# Chapter 1

General Information

## 1.1 Introduction

- Intel® N450/D510 processor
- EBX form factor standard, supports PC/104 plus
- One SODIMM up to 2G DDR2 667/800MHz
- Dual Display: VGA + LVDS
- Supports 8 x USB 2.0 ports
- Supports 3 x SATAII
- Supports up to 6 x COM (Support Auto flow control)
- Supports up to 2 x Watchdog Timer
- Supports up to 3 x Intel Giga Ethernet support
- UL60601 design in GbE3 and COM6 (Full version only, UL60601 cert is for Medical )
- Supports Wake-on-LAN, Wake-on-Modem
- Power off protection and Software I<sup>2</sup>C API support

## 1.2 Product Specifications

### General

CPU	N450/D510 1.6GHz
L2 Cache	512KB/1MB
System Chipset	N450/D510 + ICH8M
BIOS	AMI 16Mb SPI BIOS
System Memory	One SODIMM up to 2GB DDR2 667/800MHz
Power Management	APM1.2, ACPI support
SSD	CF card type I/II
Watchdog Timer	
WD1: Can be IWD and PWD	10ms, disable, 1sec and 60sec interval timer
WD2: PWD (Full version only)	255-level interval timer, setup by software, Super I/O integrated, SMSC Controller
Expansion Interface	Supports PC-104 plus, PCI slot x1, Mini PCIe
Battery	Lithium 3 V / 196 mAH

### I/O

I/O Interface	1 x CF, 3 x SATAII, 1 x K/B, 1 x Mouse, 4 x RS232 (COM6 ,UL60601 design, is full version only), 2 x RS232/422/485 (Default RS-422/485, RS-232 with TX/RX only is optional by request), 1 x LPT
USB	8 x USB 2.0 compliant Ports
Audio	AC97, Line-in, Line-out, Mic-in, speaker out (R/L)
IrDA -	115kbps (optional by request) shared from COM2
GPIO	16-bit general purpose

### Ethernet

Chipset	GbE1 : Intel 82567, GbE2 : Intel 82583V, Optional GbE3: Intel 82583V (UL60601 Compliant)
Speed	10/100/1000Mbps
Interface	3 (RJ-45 connector through the cable and GbE3 is full version only)

Standard	IEEE 802.3u 100Base-T & IEEE 802.3ab 1000Base-T for 10/100/1000Mbps optional
<b>Display</b>	
Controller	Embedded Gen3.5+ GFX Core
VRAM	Shared Memory Architecture up to 224 MB system memory
LVDS LCD	Single channel 18-bit LVDS up to WXGA 1366 x 768
VGA	Supports up to SXGA 1400 x 1050 @ 60 Hz for Atom N450, up to 2048 x 1536 for Atom D510
Dual Independent Display	VGA+ LVDS

## 1.3 Chipset

### 1.3.1 Functional Specifications

#### 1.3.1.1 Processor

- Intel N450/D510 processor 1.6GHz (512KB/ 1MB)
- CPU Process: 45nm.
- 667/800 MHz FSB Support

#### 1.3.1.2 Chipset

North Bridge	
Controller Hub	Intel® N450/D510
FSB	667/800 MHz
Memory	DDRII 667/800 SDRAM
Display	
Chipset	Intel® N450/D510 +ICH8M
Dual independent display	VGA+LVDS(18-bit) (Supports Clone and Twin mode)
VGA Memory	Up to 224 MB of dynamic video memory allocation
	VGA: Supports QXGA Up to 2048 x 1536
Display	LVDS: Resolution up to 18 bpp, XGA (1024 x 768) and WXGA (1280 x 800)
Internal Graphics Features	* Intel 3.5 Gen Integrated Graphic Engine + GFX core * DVMT 3.0 (Dynamic Video Memory Technology) * DirectX* 9 compliant Pixel Shader 2.0 * 2 display ports: LVDS and VGA * Intel® Clear Video Technology

#### 1.3.1.3 Chipset (ICH8-M)

I/O Interface	
LPT	1 (FDD is optional)
RS-232	4 (COM6 ,UL60601 design, is full version only)
RS-232/422/485	2 (RS-232 with TX/RX only is optional by request)
K/B	1
Mouse	1
USB	8 x USB 2.0

Audio	HD Audio, ALC888 Codec, Line-in, Line-out, Mic-in, speaker out (R/L) (Supports 8Ω 1W or 4Ω 2 W Speaker for Speaker-out)
GPIO	16-bit GPIO
IrDA	115 kbps (optional by request) shared from COM2
South Bridge	
Controller Hub	ICH8M
PCI Compliant	PCI 2.3
PCI Bus	* PCI masters PC/104-Plus (ISA doesn't support DMA)
Other Features	* 8 x USB 2.0 ports, 480MB/s (all internal connectors) Default: 500mA @ one port (Up to 1A @ 2 ports) * 3 x SATAII (Max. Data transfer Rate 300MB/s) * HD Audio CODEC (ALC888) * Power Management (S0, S1, S3,S4, S5)
BIOS	16 Mb Flash BIOS via SPI

#### 1.3.1.4 Others

Ethernet	
Chipset	GbE 1 : Intel 82567V GbE 2: Intel 82583V GbE 3: Intel 82583V (UL60601 design, optional)
IEEE Compliant	Compliant with IEEE 802.3, IEEE 802.3u, IEEE 802.3x, IEEE 8023y, IEEE 802.ab
Disable LAN through BIOS	Yes
Driver Support	WES7/Windows XP/XP Embed/CE, Linux, QNX
Audio	
Codec	HD Audio, ALC888 Codec
Connector	Line in, Line out, Mic in, Speak out (R/L, 8 Ohm 1W/4Ohm 2W)
Hardware Monitor	
Super I/O	LPC I/O for onboard alarm SCH3106
Fan	1. Smart FAN Support. 2. Programmable automatic fan monitor based on temperature. 3. 2 pin connector for LED indication when fan fail or system abnormal. 4. System FAN Power Connector x 1 5. Reserve CPU FAN Power Connector x 1 Pin2: +12 V Pin3: Fan speed signal input
Temperature	CPU Temperature
Voltage	3.3 V,+5 V, +12 V, Vcore
PCI to ISA	
Chipset	ITE8888G (ISA DMA not supported)
Second watchdog timer	
Pin -Selectable Watchdog Timer	MAX6369KA-T Watchdog Timers



## 1.3.2 Mechanical Specifications

### 1.3.2.1 Dimensions (mm)

203mm(L)\*146mm(W) (8" x 5.75")

### 1.3.2.2 Height on Top (mm)

PCM-9562N-S6A1E: 15.4mm (PCI slot)

PCM-9562D-S6A1E: 25mm (CPU Cooler)

### 1.3.2.3 Height on Button (mm)

8.5mm (CF socket)

### 1.3.2.4 Heatsink/Cooler Dimensions (mm)

50\*50\*10 mm (Heatsink for PCM-9562N-S6A1E)

50\*50\*25 mm (Cooler for PCM-9562D-S6A1E)

50\*50\*30 mm (Heatsink for Extended temp product)

### 1.3.2.5 Weight (g) with Heatsink

850 g

## 1.3.3 Electrical Specifications

### 1.3.3.1 Power Supply Voltage

- **Power Type**

AT/ATX

- **Power Supply Voltage**

ATX: 12V/ 5V stand-by  $\pm 10\%$  (5V stand-by power is only for auto power off function)

AT: 12 V  $\pm 10\%$  only

### 1.3.3.2 Power Supply Current

Test Condition:

- Add-in Card - None
- MiniPCIe Card - None
- HDD - 3.5" WD 80GB SATA2 \*1
- KeyBoard/Mouse - USB or PS/2 Interface
- Display - VGA

Condition	Power Consumption (A or mA)					
	Voltage/ Condition	Power on - Boot procedure	DOS Idle Mode	Win. Idle Mode	BurnIn (10minutes)	Testing Software
	+12 V	926 mA	1037 mA	893 mA	1187 mA	BurnIn
	5 VSB	9 mA	8 mA	8 mA	10 mA	

Condition	Power Consumption (A or mA)	
	Voltage/Condition	Boot to DOS prompt mode
CPU type: Max. memory slot Qty: # size/pcs: 256MB	+12 V 5 VSB	998 mA 8 mA
CPU type: Max. memory slot Qty: # size/pcs: 512 MB	+12 V 5 VSB	989 mA 8 mA
CPU type: Max. memory slot Qty: # size/pcs: 1GB	+12 V 5 VSB	1096 mA 8 mA
CPU type: Max. memory slot Qty: # size/pcs: 2 GB	+12 V 5 VSB	1058 mA 8 mA

### 1.3.3.3 RTC Battery

- **Typical Voltage:** 3.0 V
- **Normal discharge capacity:** 196 mAh

## 1.3.4 Environmental Specifications

### 1.3.4.1 Operating Temperature

- **Operating temperature:** 0 ~ 60°C (32~140°F)

### 1.3.4.2 Operating Humidity

- **Operating Humidity:** 0% ~ 90% Relative Humidity, non-condensing

### 1.3.4.3 Storage Temperature

Standard products (0~60°C)

- **Storage temperature:** -20~70°C

### 1.3.4.4 Storage Relative Temperature

Standard products (0~60°C)

- **Relative humidity:** 95% @ 60°C

Phoenix products (-20~80°C)

- **Relative humidity:** 95% @ 60°C

Platinum Phoenix products (-40~85°C)

- **Relative humidity:** 95% @ 60°C

# Chapter 2

## Hardware Installation

This chapter explains the setup procedures of the PCM-9562 A1 hardware, including instructions on setting jumpers and connecting peripherals, switches, indicators and mechanical drawings. Be sure to read all safety precautions before you begin the installation procedure.

## 2.1 Jumpers

### 2.1.1 Jumper List

JP1	LCD Panel Power Select
JP2	VIO Select for PCI and PC104+ Slot
JP3	CMOS Clear
JP4	UART2 Mode Select
JP7	Mini PCIE Voltage Select

### 2.1.2 Jumper Settings

<b>JP1</b>	<b>LCD Panel Power Select</b>
<b>Part Number</b>	1653003101
<b>Footprint</b>	PH_3x1V_2.54mm
<b>Description</b>	PIN HEADER 3*1P 180D(M) 2.0mm DIP SQUARE W/O Pb
Setting	Function
(1-2)	+5 V
(2-3)*	+3.3 V

<b>JP2</b>	<b>VIO Select for PCI and PC104+ Slot</b>
<b>Part Number</b>	1653003100
<b>Footprint</b>	PH3x1P-2.54
<b>Description</b>	PIN HEADER 3*1P 180D(M) 2.54mm DIP WO/Pb
Setting	Function
(1-2)*	+5 V
(2-3)	+3.3 V

<b>JP3</b>	<b>CMOS Clear</b>
<b>Part Number</b>	1653003101
<b>Footprint</b>	HD_3x1P_79_D
<b>Description</b>	PIN HEADER 3*1P 180D(M) 2.0mm DIP SQUARE W/O Pb
Setting	Function
(1-2)*	Normal
(2-3)	Clear

<b>JP4</b>	<b>UART2 Mode Select</b>
<b>Part Number</b>	1653002101
<b>Footprint</b>	HD_2x1P_79_D
<b>Description</b>	PIN HEADER 2*1P 180D(M) SQUARE 2.0mm DIP W/O Pb
Setting	Function
(1-2)*	COM2
NL	IrDA

<b>JP7</b>	<b>Mini PCIE Voltage Select</b>
<b>Part Number</b>	1653003100
<b>Footprint</b>	HD_3x1P_100_D
<b>Description</b>	PIN HEADER 3*1P 180D(M) 2.54mm DIP WO/Pb
<b>Setting</b>	<b>Function</b>
(1-2)*	+3.3 V
(2-3)	+3.3 V Dual

### 2.1.3 Jumper Description

Cards can be configured by setting jumpers. A jumper is a metal bridge used to close an electric circuit. It consists of two metal pins and a small metal clip (often protected by a plastic cover) that slides over the pins to connect them. To close a jumper, you connect the pins with the clip. To open a jumper, you remove the clip. Sometimes a jumper will have three pins, labeled 1, 2 and 3. In this case you would connect either pins 1 and 2, or 2 and 3.

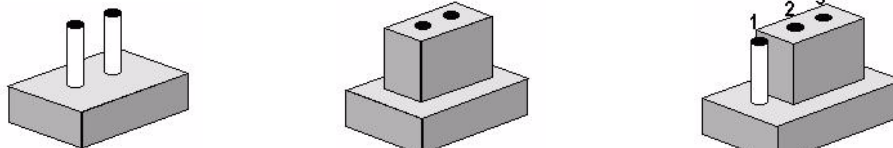

The jumper settings are schematically depicted in this manual as follows.

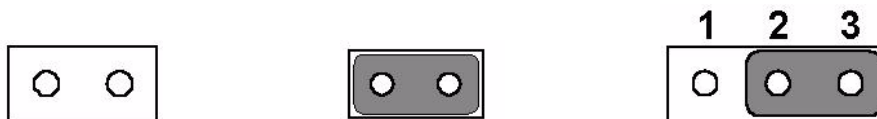

A pair of needle-nose pliers may be helpful when working with jumpers. If you have any doubts about the best hardware configuration for your application, contact your local distributor or sales representative before you make any changes.

**Warning!** To avoid damaging the computer, always turn off the power supply before setting jumpers to clear CMOS. Before turning on the power supply, set the jumper back to 3.0 V Battery On.



## 2.2 Connectors

### 2.2.1 Connector List

CN1	DDR2 SODIMM Socket
CN2	Audio CD-In Connector
CN4	Audio Connector
CN5	Power Connector
CN6	Inverter Connector
CN8	VGA Connector
CN9	LVDS Connector
CN10	GbE1 Connector
CN11	GbE1,2 LED Connector
CN12	GbE2 Connector
CN13	HDD LED and POWER LED Connector
CN14	GbE3 Connector
CN15	LPT / FDD Connector
CN16	Standby Power Connector
CN17	PC-104/+ Connector
CN18	GbE3 LED Connector
CN20	USB1/2 Connector
CN21	USB3/4 Connector
CN22	Reset Button Connector
CN23	Power Button Connector
CN24	SIR Connector
CN25	PS2 Keyboard/Mouse Connector
CN26	CF TYPEII Connector
CN28	USB5/6 Connector
CN29	USB7/8 Connector
CN30	Mini PCIE Slot
CN31	Mini PCIE Lock
CN32	SATA 1 Connector
CN33	SATA 2 Connector
CN34	SATA 3 Connector
CN35	GPIO1 Connector
CN36	GPIO2 Connector
CN37	SMBUS Connector
CN38	I <sup>2</sup> C Connector
CN39	COM1 Connector
CN40	COM2 Connector
CN41	COM3 Connector
CN42	COM4/5 (422/485) Connector
CN43	COM6 Connector
CN44	-5 V and -12 V Connector
CN45	SPI Flash Socket
CN46	SATA Power Connector
FAN1	System Fan Connector
FAN2	CPU Fan Connector
PCI1	PCI SLOT

## 2.2.2 Connector Settings

### Audio CD-In Connector (CN16)

CD In cable used to send audio CD sound to the computer's audio chipset via CN16.

### Audio Connector (CN4)

The Audio link is a 2x8 pin connector, the PCM-9562 can support speaker-out, Line-IN, Line-out with Realtek ALC888, HD audio. Detailed pin assignments refer to Appendix A.

### Power Connector (CN5)

PCM-9562 can support both ATX and AT power supply.

#### 1. ATX power supply:

You can use standard 4 pins 12V power output from power supply directly to connect to CN5. For auto power off feature, you should use cable 1700015741 connecting to CN16 (Standby Power Connector) to provide 5VSB power input.

#### 2. AT power supply:

You can use standard 4 pins 12V power output from power supply directly to connect to CN5.

### Inverter Connector (CN6)

PCM-9562 can provide +5 V and +12 V and signal to LCD inverter board via CN6.

### VGA Connector (CN8)

The DB15-pin female connector is provided for video monitors.

### LVDS Connector (CN9)

**Low-voltage differential signaling**, or **LVDS**, is an electrical signaling system that can run at very high speeds over inexpensive twisted-pair copper cables. LVDS is a differential signaling system, which means that it transmits two different voltages which are compared at the receiver. LVDS uses this difference in voltage between the two wires to encode the information.

PCM-9562 supports 18bit LVDS panel via CN9.

### Ethernet Connector (CN10, CN12, CN14)

For the Ethernet port, PCM-9562 equipped with 3 high performance giga ethernet ports which are fully compliant with IEEE 802.3ab 1000Base-T. It is supported by all major network operating systems.

### GbE1/2 LED connector (CN11)

CN11 is a connector for GbE1 and GbE2 indication LED.

### HDD LED and POWER LED Connector (CN13)

CN13 is a front panel connector to indicate power and HDD status.

---

### **LPT Connector (CN14)**

PCM-9562 can support LPT or Floppy via CN15. **LPT** (Line Print Terminal) is the original, yet still common, name of the parallel port interface on IBM PC-compatible computers. It was designed to operate a text printer that used IBM's 8-bit extended ASCII character set.

### **Standby Power Connector (CN16)**

PCM-9562 can support both ATX and AT power supply.

1. **ATX power supply:**

You can use standard 4 pins 12 V power output from power supply directly to connect to CN5. For auto power off feature, you should use cable 1700015741 connect to CN16 (Standby Power Connector) to provide 5VSB power input.

2. **AT power supply:**

You can use standard 4 pins 12 V power output from power supply directly to connect to CN5.

### **PC104 plus Connector (CN17)**

PCM-9562 supports PC-104 plus and it includes PCI and ISA interface which are follow PC-104 standard. It is intended for industrial embedded computing environments where applications depend on reliable data acquisition.

### **GbE3 LED Connector (CN18)**

CN18 is a connector for GbE3 indication LED.

### **USB Connectors (CN20, CN21, CN28, CN29)**

The board provides up to 8\* USB (Universal Serial Bus) ports. This gives complete Plug and Play, and hot attach/detach for up to 127 external devices. The USB interfaces comply with USB specification Rev. 2.0 which supports 480Mbps transfer rate, and are fuse protected.

### **Reset Button Connector (CN22)**

CN22 is for system reset button. System reset clears any pending errors or events and bring a system to normal condition or initial state.

### **Power Button Connector (CN23)**

CN23 is 2 pin wafer type connector and support to turn on/off system.

### **SIR Connector (CN24)**

The boards can support IrDA function (optional by request). The function is shared from COM2 and data transfer rate is up to 115kbps.



**PS/2 keyboard and mouse Connector (CN25)**

PCM-9562 can support PS/2 keyboard and mouse via CN25. The PS/2 connector is used for connecting some keyboards and mouse to a PC compatible computer system. Its name comes from the IBM Personal System/2 series of personal computers, with which it was introduced in 1987. The PS/2 mouse connector generally replaced the older DE-9 RS-232 "serial mouse" connector, while the keyboard connector replaced the larger 5-pin DIN used in the IBM PC/AT design.

**CF TYPE I/II Connector (CN26)**

CompactFlash (CF) is a mass storage device format used in portable electronic devices. For storage, CompactFlash typically uses flash memory in a standardized enclosure. PCM-9562 has CF slot and it can support CompactFlash card type I/II.

**Mini PCIe Connector (CN30)**

PCI Express Mini Card (also known as Mini PCI Express, Mini PCIe, and Mini PCI-E) is a replacement for the Mini PCI form factor based on PCI Express. It is developed by the PCI-SIG. The host device supports both PCI Express and USB 2.0 connectivity, and each card uses whichever the designer feels most appropriate to the task. PCM-9562 support a Mini PCIe slot.

**SATA Connector (CN32, CN33 and CN34)**

PCM-9562 comply Serial ATA 2.5 spec and data transfer rates up to 300 MB/s, enabling very fast data and file transfer, and independent DMA operation on two ports.

The Serial Advanced Technology Attachment computer bus has the primary function of transferring data between the motherboard and mass storage devices (such as hard disk drives and optical drives) inside a computer.

**GPIO Connector (CN35 and CN36)**

GPIO is General Purpose Input Output. PCM-9562 supports 16-bit programmable I/O via CN35 and CN36. These GPIO pin can be programmed as data input pin or output control signal pin to control device.

**SMBus Connector (CN37)**

The System Management Bus (abbreviated to SMBus or SMB) is a simple two-wire bus, derived from I<sup>2</sup>C and used for communication with low-bandwidth devices on a motherboard, especially power related chips such as a laptop's rechargeable battery subsystem (see Smart Battery Data). Other devices might include temperature, fan or voltage sensors, lid switches and clock chips. PCI add-in cards may connect to a SMBus segment.

The SMBus was defined by Intel in 1995. It carries clock, data, and instructions and is based on Philips' I<sup>2</sup>C serial bus protocol. Its clock frequency range is 10 kHz to 100 kHz. Its voltage levels and timings are more strictly defined than those of I<sup>2</sup>C, but devices belonging to the two systems are often successfully mixed on the same bus.

**I<sup>2</sup>C connector (CN38)**

I<sup>2</sup>C (Inter-Integrated Circuit) is a multi-master serial computer bus invented by Philips that is used to attach low-speed peripherals to a motherboard, embedded system, or cellphone. The name is pronounced eye-squared-see or eye-two-see.

I<sup>2</sup>C uses only two bidirectional open-drain lines, Serial Data (SDA) and Serial Clock (SCL), pulled up with resistors. Typical voltages used are +5 V or +3.3 V although systems with other, higher or lower, voltages are permitted.

The I<sup>2</sup>C reference design has a 7-bit address space with 16 reserved addresses, so a maximum of 112 nodes can communicate on the same bus.

**COM port connector (CN39, CN40, CN41, CN42 and CN43)**

COM is the original, yet still common, name of the serial port interface on IBM PC-compatible computers. PCM-9562 can support 4 RS-232 ports (CN39, CN40, CN41, CN43) and 2 RS-422/485 (CN42). COM6 (CN43) is photo isolated and complies with UL60601.

**-5 V and -12 V Connector (CN44)**

CN44 is a wafer type 3-pin connector for -5 V and -12 V.

**SPI Flash socket (CN45)**

CN45 is a socket for BIOS flash. PCM-9562 uses a 16Mbit capacity flash for BIOS.

**SATA Power Connector (CN46)**

CN46 is SATA Power Connector

## 2.3 Mechanical

### 2.3.1 Jumper and Connector Location

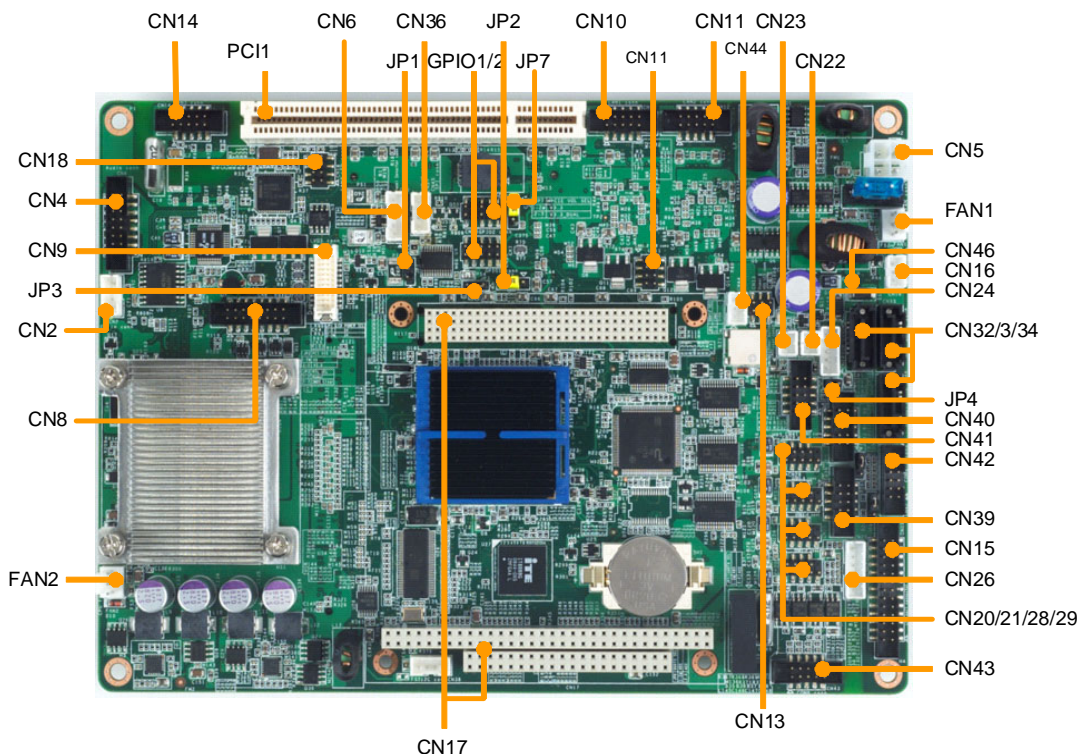

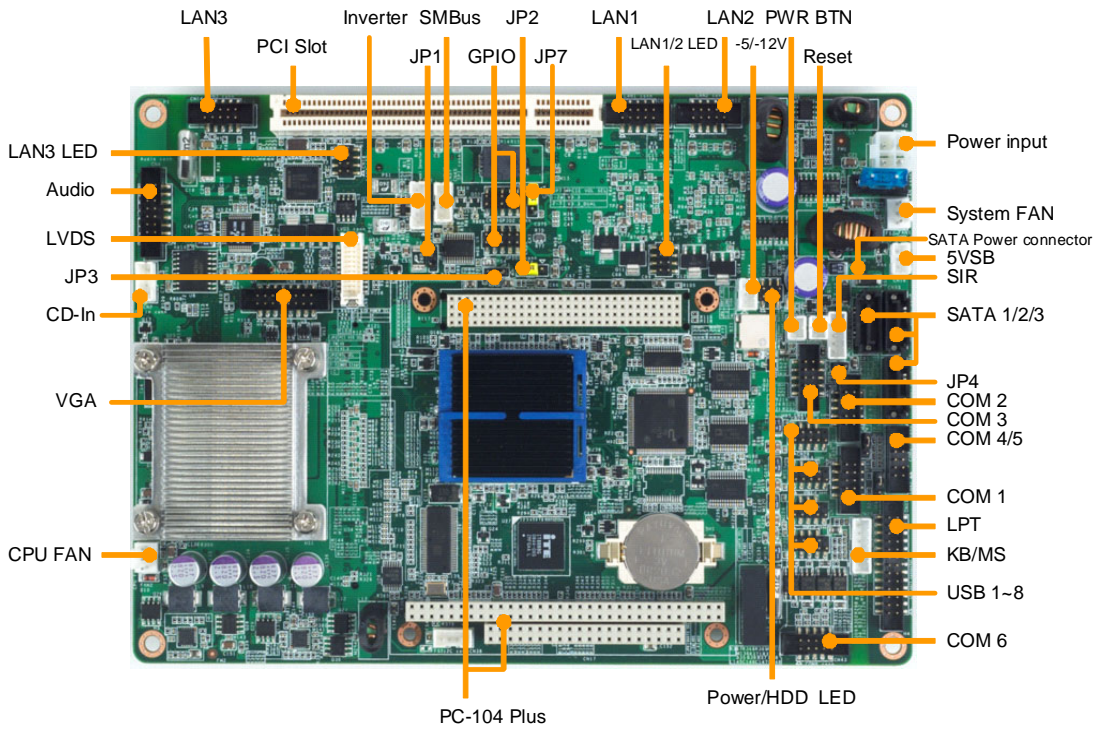
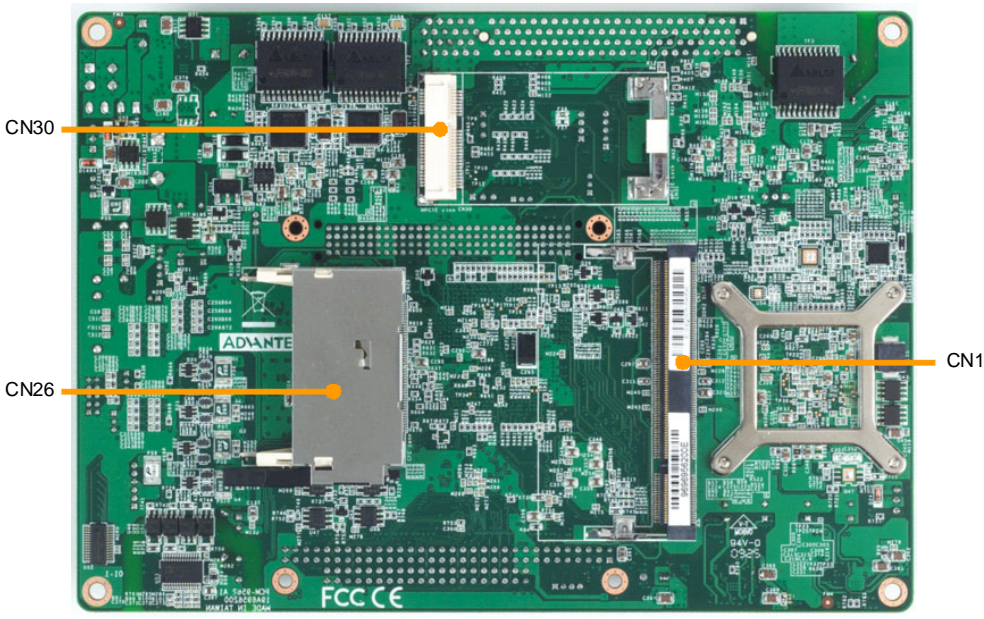

Figure 2.1 Jumper and Connector Layout (Component Side)





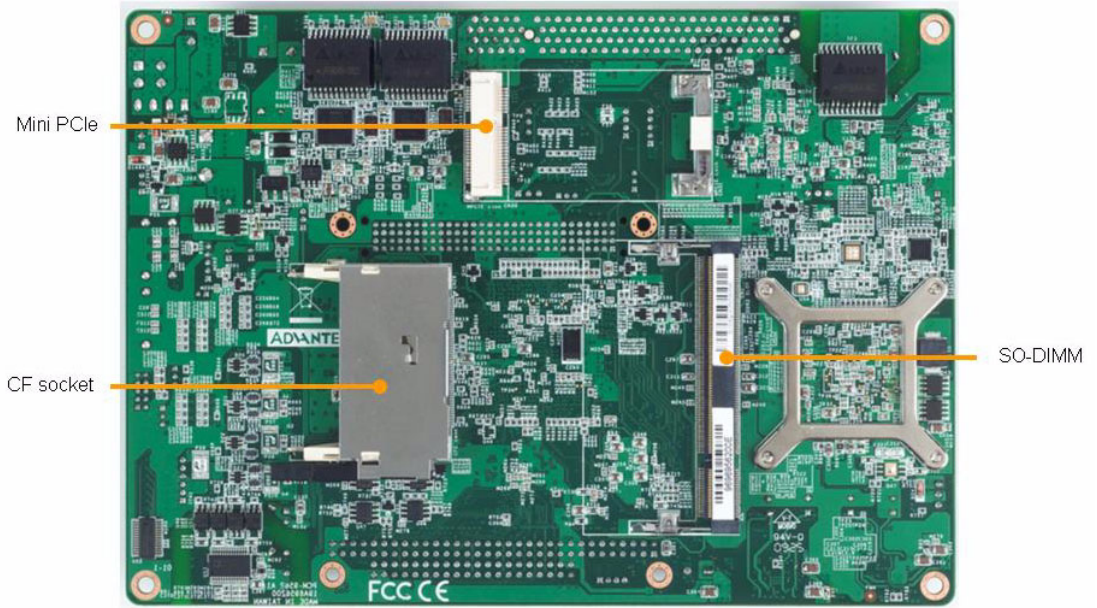

Figure 2.2 Jumper and Connector Layout (Solder Side)

### 2.3.2 Board Dimensions

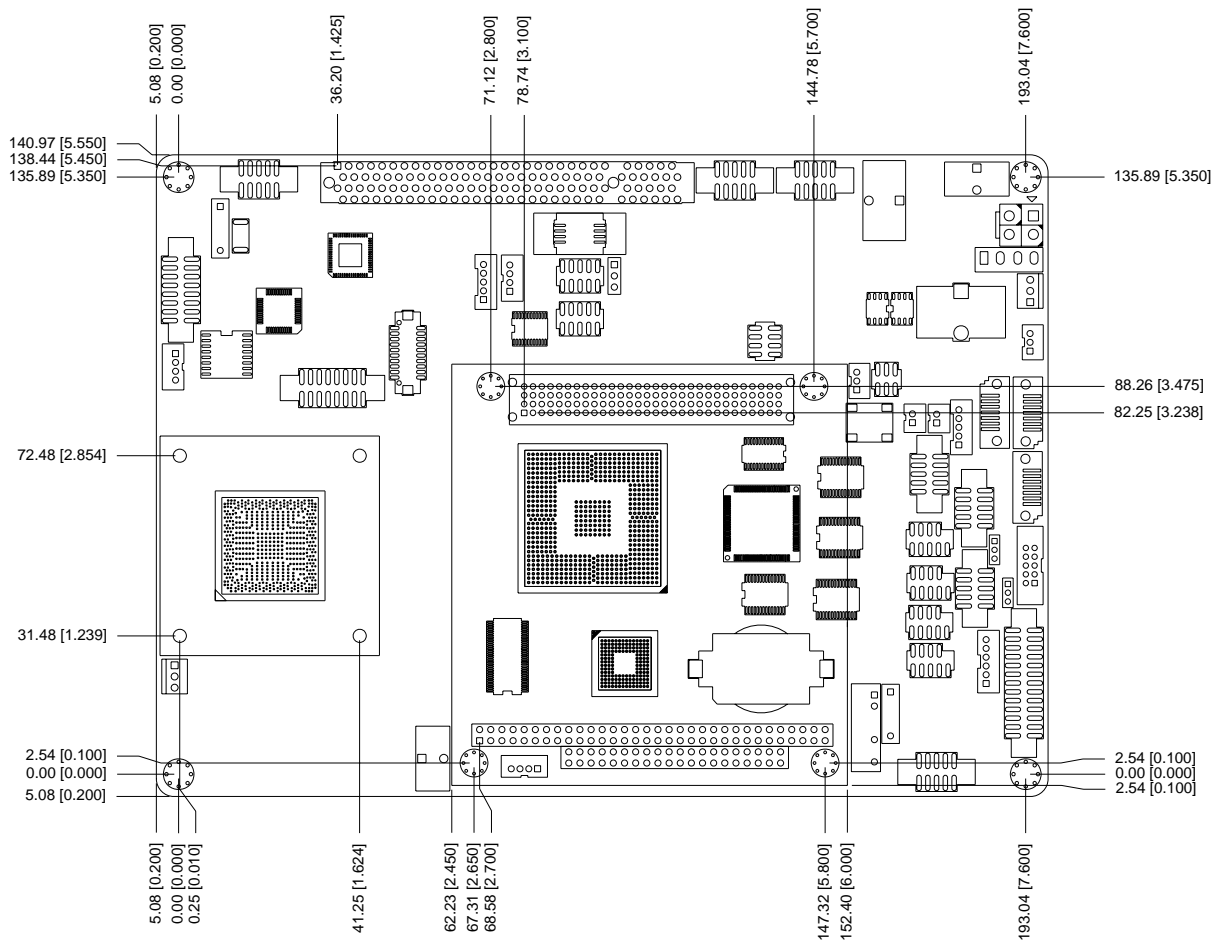

Figure 2.3 Board Dimension Layout (Component Side)

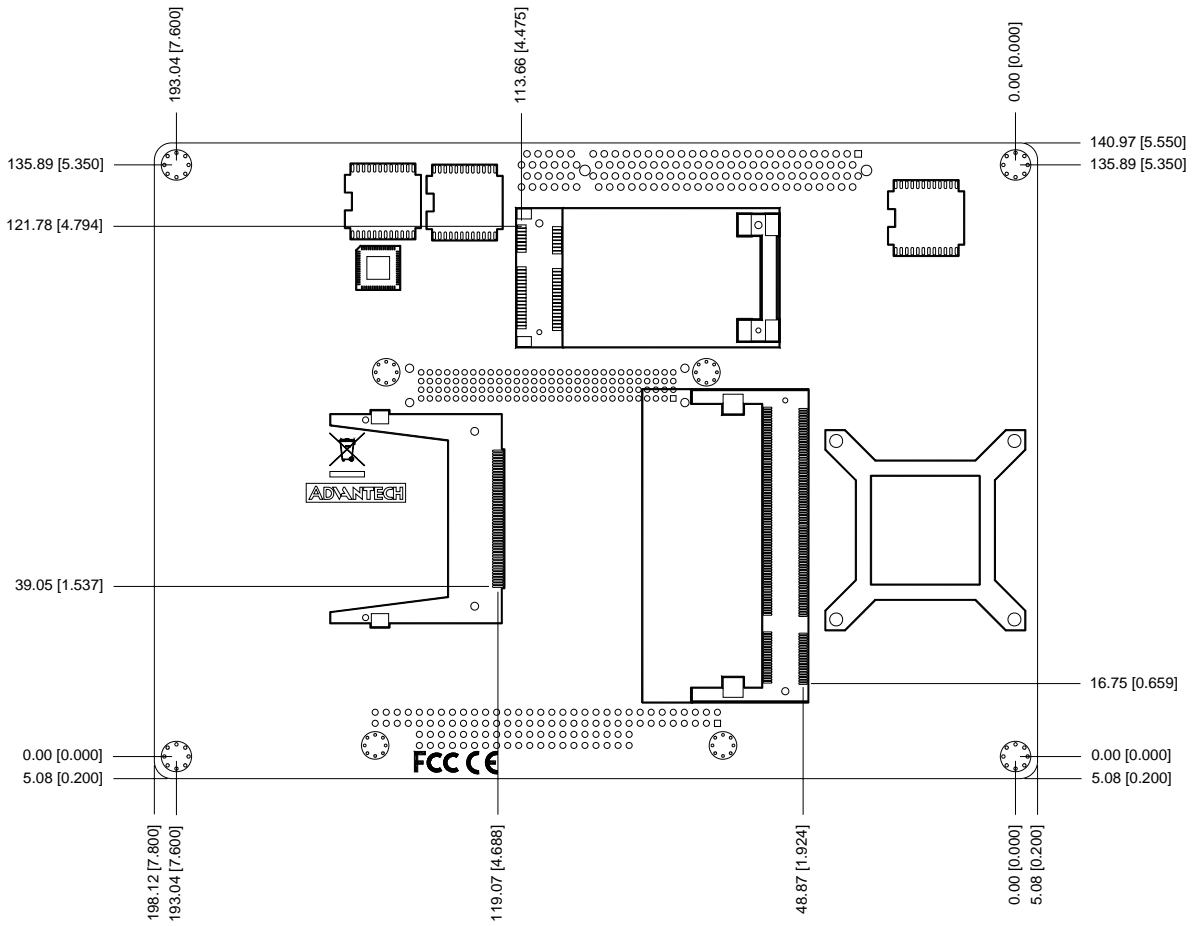

Figure 2.4 Board Dimension Layout (Solder Side)



# Chapter 3

BIOS Settings

AMIBIOS has been integrated into many motherboards for over a decade. With the AMIBIOS Setup program, you can modify BIOS settings and control the various system features. This chapter describes the basic navigation of the PCM-9562 BIOS setup screens.

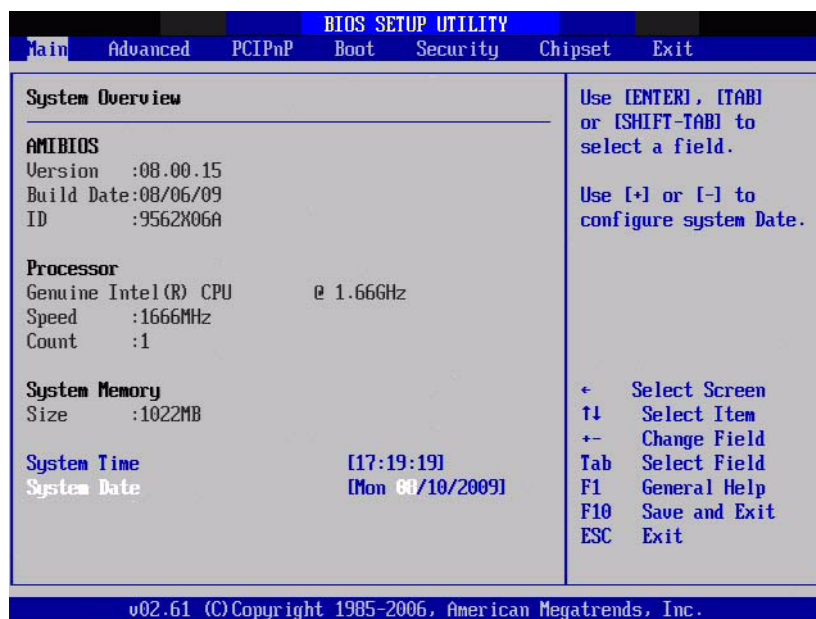

**Figure 3.1 Setup program initial screen**

AMI's BIOS ROM has a built-in Setup program that allows users to modify the basic system configuration. This information is stored in battery-backed CMOS so it retains the Setup information when the power is turned off.

## 3.1 Entering Setup

Turn on the computer and check for the “patch” code. If there is a number assigned to the patch code, it means that the BIOS supports your CPU. If there is no number assigned to the patch code, please contact an Advantech application engineer to obtain an up-to-date patch code file. This will ensure that your CPU's system status is valid. After ensuring that you have a number assigned to the patch code, press <DEL> and you will immediately be allowed to enter Setup.

## 3.2 Main Setup

When you first enter the BIOS Setup Utility, you will enter the Main setup screen. You can always return to the Main setup screen by selecting the Main tab. There are two Main Setup options. They are described in this section. The Main BIOS Setup screen is shown below.



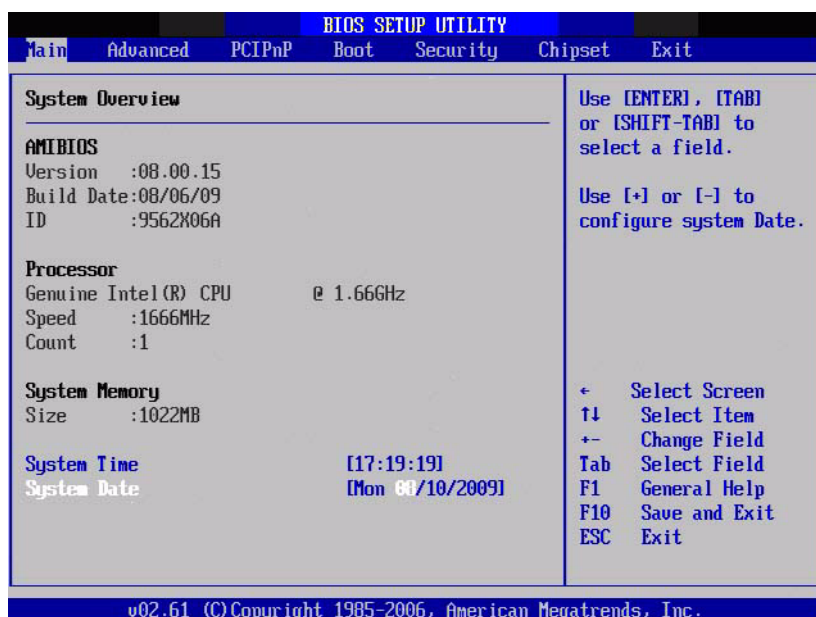

**Figure 3.2 Main setup screen**

The Main BIOS setup screen has two main frames. The left frame displays all the options that can be configured. Grayed-out options cannot be configured; options in blue can. The right frame displays the key legend.

Above the key legend is an area reserved for a text message. When an option is selected in the left frame, it is highlighted in white. Often a text message will accompany it.

### 3.2.1 System time / System date

Use this option to change the system time and date. Highlight System Time or System Date using the <Arrow> keys. Enter new values through the keyboard. Press the <Tab> key or the <Arrow> keys to move between fields. The date must be entered in MM/DD/YY format. The time must be entered in HH:MM:SS format.

## 3.3 Advanced BIOS Features Setup

Select the Advanced tab from the PCM-9562 setup screen to enter the Advanced BIOS Setup screen. You can select any of the items in the left frame of the screen, such as CPU Configuration, to go to the sub menu for that item. You can display an Advanced BIOS Setup option by highlighting it using the <Arrow> keys. All Advanced BIOS Setup options are described in this section. The Advanced BIOS Setup screens is shown below. The sub menus are described on the following pages.



Figure 3.3 Advanced BIOS features setup screen

### 3.3.1 CPU Configuration

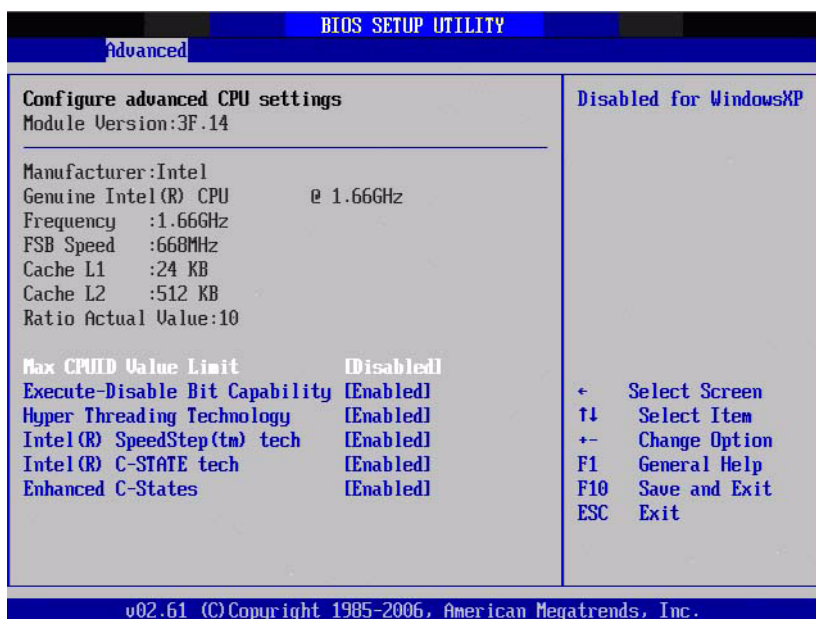

Figure 3.4 CPU Configuration Setting

#### Max CPUID Value Limit

This item allows you to limit CPUID maximum value.

#### Execute-Disable Bit Capability

This item allows you to enable or disable the No-Execution page protection technology.

#### Hyper Threading Technology

This item allows you to enable or disable Intel Hyper Threading technology.

#### Intel® SpeedStep™ tech

When set to disabled, the CPU runs at its default speed, when set to enabled, the CPU speed is controlled by the operating system.

**Intel® C-STATE tech**

This item allows the CPU to save more power under idle mode.

**Enhanced C-States**

CPU idle set to enhanced C-States, disabled by Intel® C-STATE tech item.

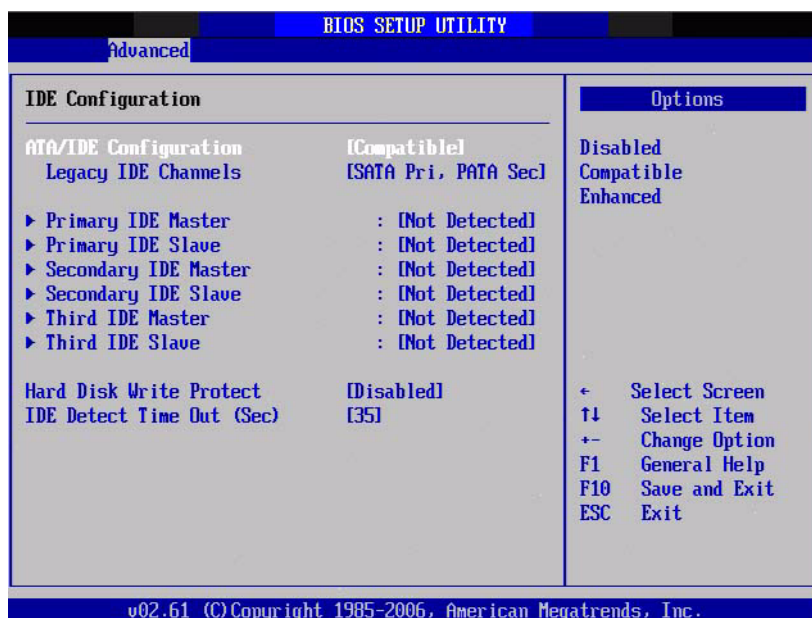
**3.3.2 IDE Configuration**

**Figure 3.5 IDE Configuration**

**ATA/IDE Configuration**

This item allows you to select Disabled / Compatible / Enhanced.

**Legacy IDE Channels**

When set to Enhanced mode you can select IDE or AHCI mode. When select Compatible mode you can select SATA only / SATA pri, PATA sec or PATA only.

**Primary/Secondary/Third IDE Master/Slave**

BIOS auto detects the presence of IDE device, and displays the status of auto detection of IDE device.

- **Type:** Select the type of SATA driver.[Not Installed][Auto][CD/DVD][ARMD]
- **LBA/Large Mode:** Enables or Disables the LBA mode.
- **Block (Multi-Sector Transfer):** Enables or disables data multi-sectors transfers.
- **PIO Mode:** Select the PIO mode.
- **DMA Mode:** Select the DMA mode.
- **S.M.A.R.T.:** Select the smart monitoring, analysis, and reporting technology.
- **32Bit Data Transfer:** Enables or disables 32-bit data transfer.

**Hard Disk Write Protect**

Disable/Enable device write protection. This will be effective only if device is accessed through BIOS.

**IDE Detect Time Out (Sec)**

This item allows you to select the time out value for detecting ATA/ATAPI device(s).

### 3.3.3 Floppy Configuration



Figure 3.6 Floppy Configuration

#### Floppy B

Select the type of floppy drive, if any, connected to the system. We suggest you disable the floppy if installing Windows Vista without a floppy drive.

### 3.3.4 Super I/O Configuration

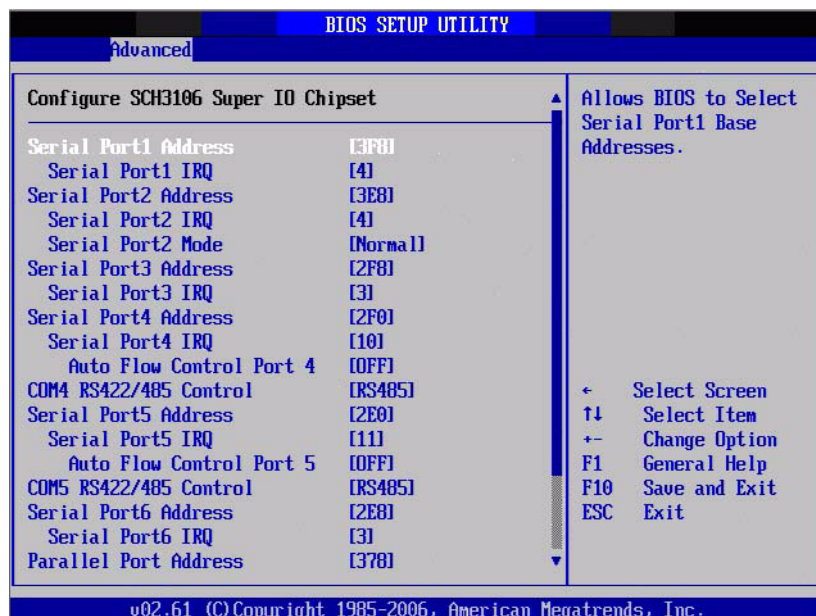

Figure 3.7 Super I/O Configuration

#### Serial Port1 / Port2 / Port3 / Port 4 / Port 5 / Port 6 address

This item allows you to select serial port1 ~ port6 of base addresses.

#### Serial Port1 / Port2 / Port3 / Port 4 / Port 5 / Port 6 IRQ

This item allows you to select serial port1 ~ port6 of IRQ.

#### Serial port2 Mode

This option configures serial port 2 mode.

**Auto Flow Control Port4 / Port5**

This item allows you to enable or disable auto flow control function.

**COM4 / COM5 RS422/485 Control**

This item allows you to select RS422 or RS485 control.

**Parallel Port Address**

This item allows you to select parallel port of base addresses.

**Parallel Port Mode**

This item allows you to select parallel port of mode.

**Parallel Port IRQ**

This item allows you to select parallel port of IRQ.

**LPT/FDD Switch**

This function will switch LPT port to FDD mode.

**WatchDog Function**

WatchDog function support (Seconds/Minutes).

### 3.3.5 Hardware Health Configuration

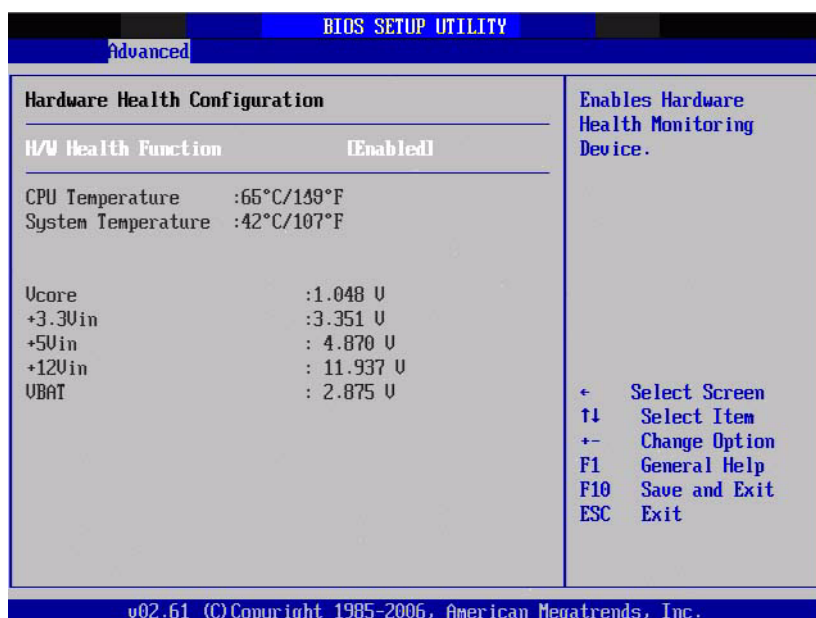

**Figure 3.8 Hardware health configuration**

**H/W Health Function**

This item allows you to control H/W monitoring.

**Temperature & Voltage show**

CPU/System Temperature

Vcore / +3.3Vin / +5Vin / +12Vin / VBAT

### 3.3.6 ACPI Settings

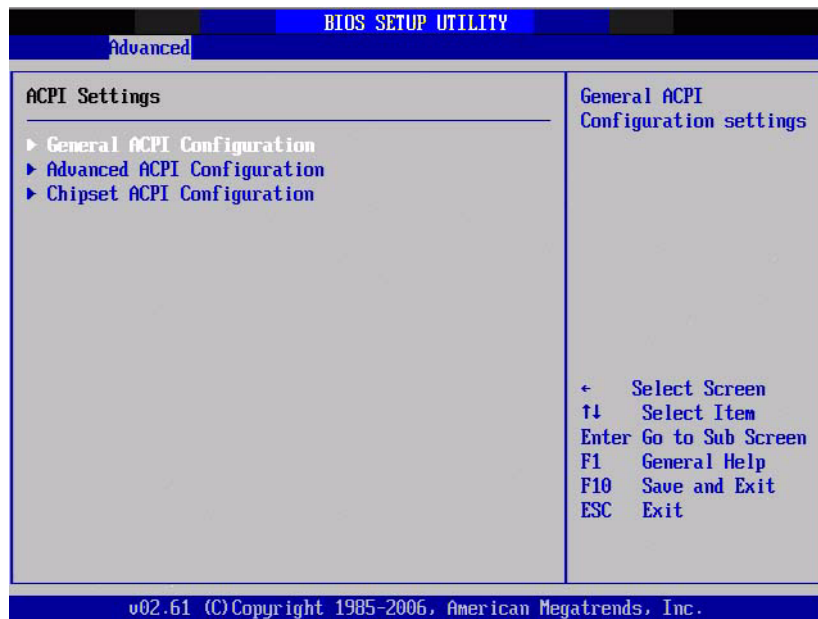

Figure 3.9 ACPI Settings

#### 3.3.6.1 General ACPI Configuration

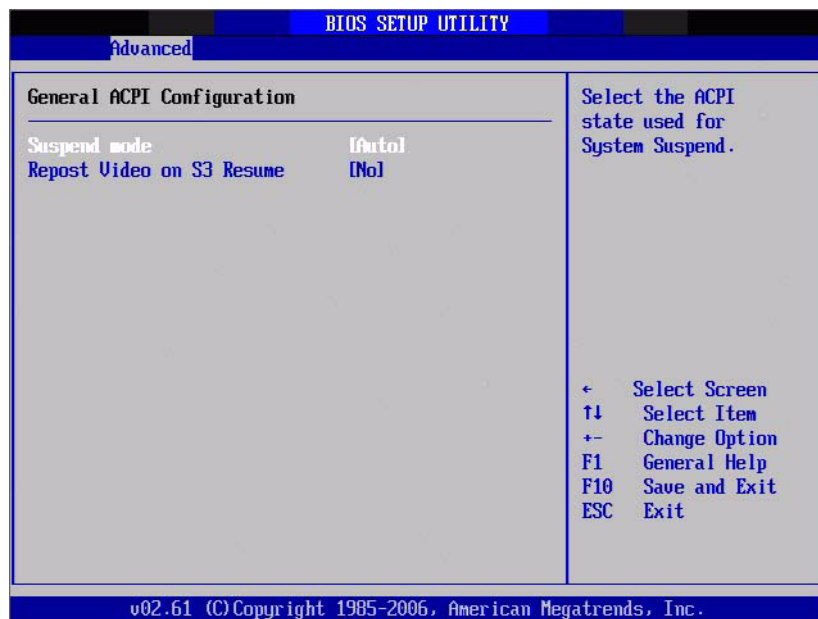

Figure 3.10 General ACPI Configuration

#### Suspend mode

Select the ACPI state used for system suspend.

#### Report Video on S3 Resume

This item allows you to invoke VA BIOS POST on S3/STR resume.



### 3.3.6.2 Advanced ACPI Configuration

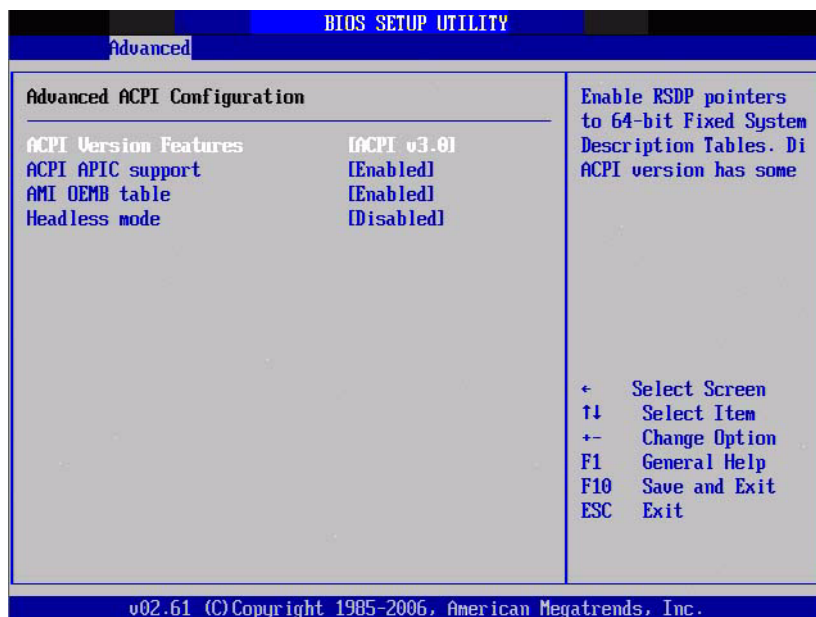

Figure 3.11 Advanced ACPI Configuration

#### ACPI Version Features

This item allows you to enable RSDP pointers to 64-bit fixed system description tables.

#### ACPI APIC support

Include APIC table pointer to RSDT pointer list.

#### AMI OEMB table

Include OEMB table pointer to R(x)SDT pointer lists.

#### Headless mode

Enable / Disable Headless operation mode through ACPI.

### 3.3.6.3 Chipset ACPI Configuration

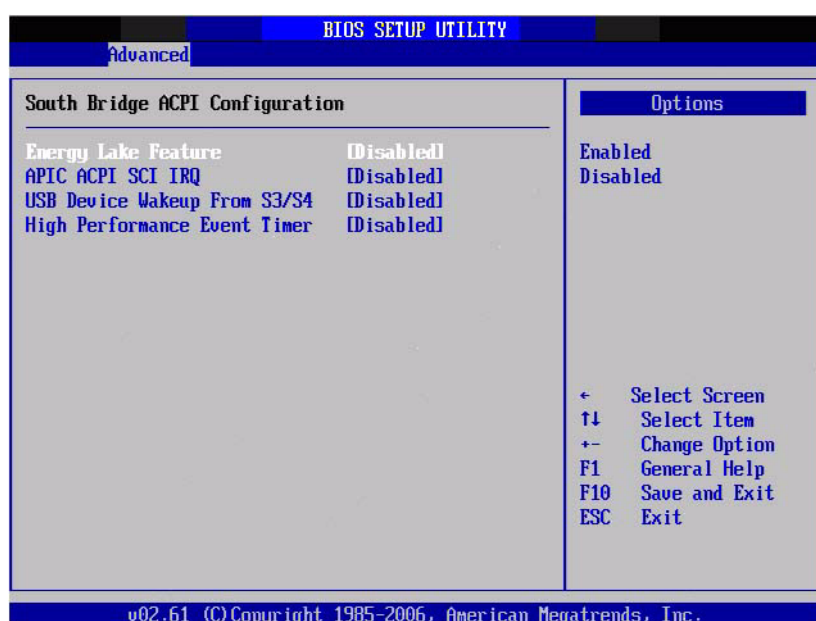

Figure 3.12 Chipset ACPI Configuration

### Energy Lake Feature

Allows you to configure Intel's Energy Lake power management technology.

### APIC ACPI SCI IRQ

Enable/Disable APIC ACPI SCI IRQ.

### USB Device Wakeup From S3/S4

Enable/Disable USB Device Wakeup from S3/S4.

### High Performance Event Timer

Enable/Disable High performance Event timer.

## 3.3.7 AHCI Configuration

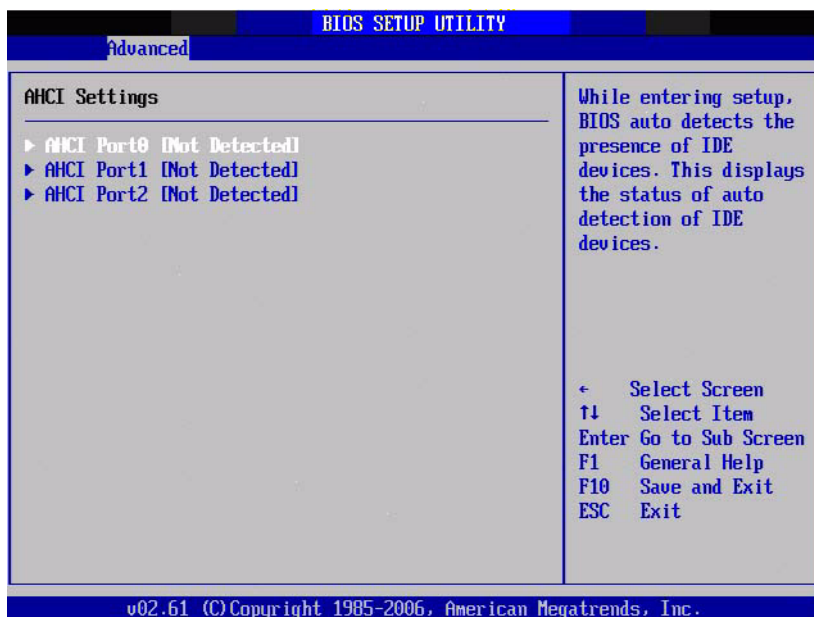

Figure 3.13 Advanced ACPI Configuration

### AHCI Ports0 / Port1 / Port2

While entering setup, BIOS auto detects the presence of IDE devices. This displays the status of auto detection of IDE device.



### 3.3.8 APM Configuration

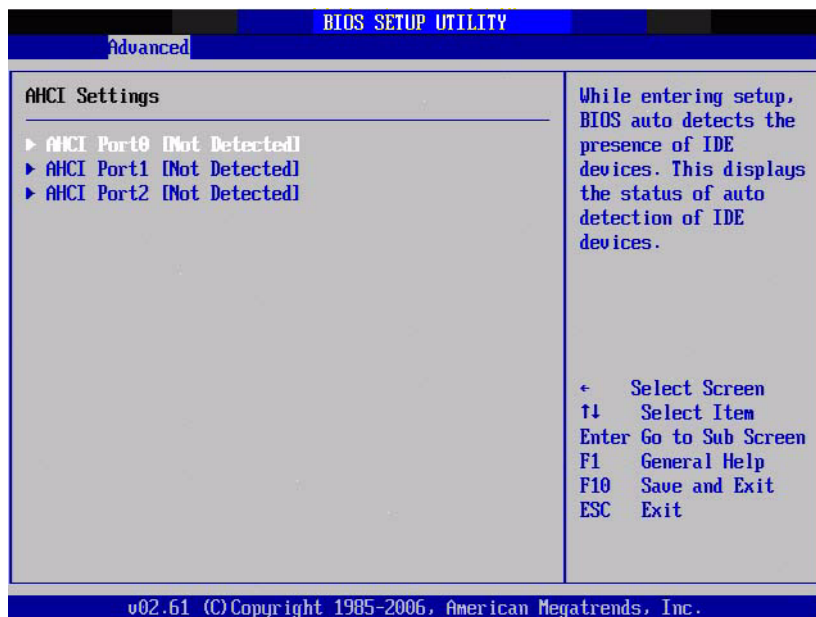

Figure 3.14 APM Configuration

#### Power Management/APM

Enable or disable APM.

#### Power Button Mode

Power on, off, or enter suspend mode when the power button is pressed. The following options are also available.

#### Restore on AC power Loss

Use this to set up the system response after a power failure. The "Off" setting keeps the system powered off after power failure, the "On" setting boots up the system after failure, and the "Last State" returns the system to the status just before power failure.

#### Video Power Down Mode

Power down video in suspend or standby mode.

#### Hard Disk Power Down Mode

Power down Hard Disk in suspend or standby mode.

#### Standby Time Out

Go into standby in the specified time.

#### Suspend Time Out

Go into Suspend in the specified time.

#### Resume On Ring

Enable / Disable RI to generate a wake event.

#### Resume On PME#

Enable / Disable PME to generate a wake event.

#### Resume On RTC Alarm

Enable / Disable RTC to generate a wake event.

### 3.3.9 Event Log Configuration

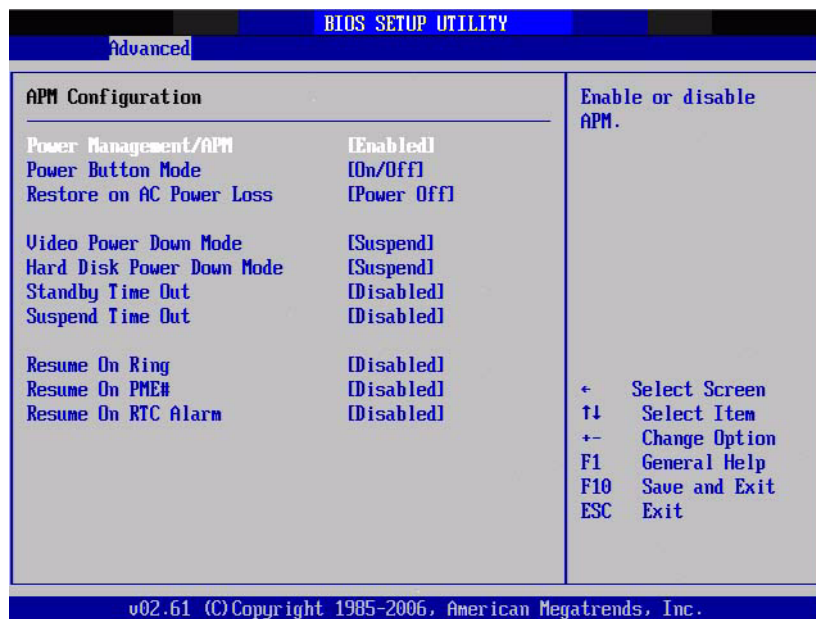

Figure 3.15 South Bridge ACPI Configuration

#### View Event Log

View all unread events on the event Log.

#### Mark all events as read

Mark all unread events as read.

#### Clear Event Log

Discard all events in the event Log.

### 3.3.10 MPS Configuration

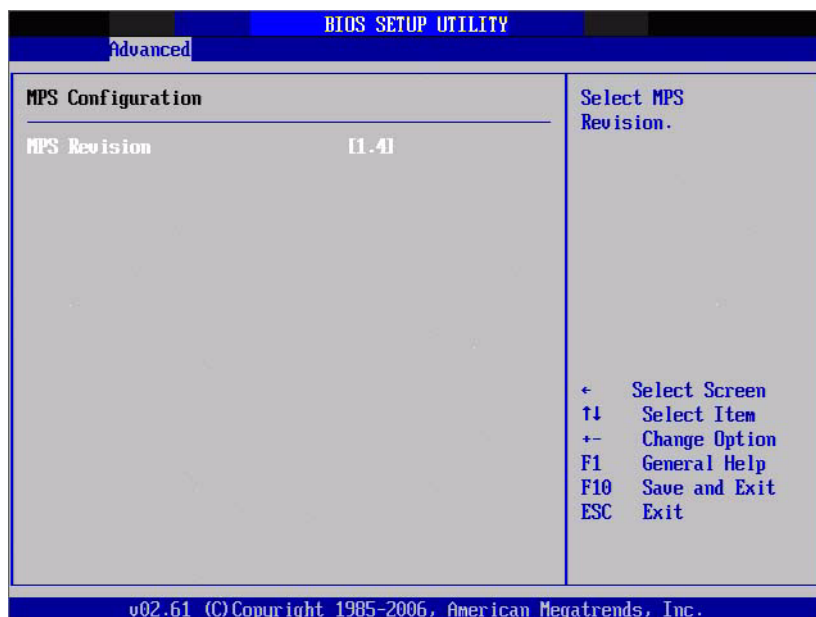

Figure 3.16 South Bridge ACPI Configuration

#### MPS Revision

This item allows you to select MPS reversion.

### 3.3.11 SMBIOS Configuration



**Figure 3.17 South Bridge ACPI Configuration**

#### **SMBIOS SMI Support**

SMBIOS SMI wrapper support for PnP function 50h-54h.

### 3.3.12 USB Configuration



**Figure 3.18 South Bridge ACPI Configuration**

#### **Legacy USB Support**

Enables support for legacy USB. Auto option disables legacy support if no USB devices are connected.

#### **USB 2.0 Controller Mode**

This item allows you to select HiSpeed(480Mbps) or FullSpeed (12Mbps).

#### **BIOS EHCI Hand-Off**

This is a workaround for OSES without EHCI hand-off support. The EHCI ownership change should claim by EHCI driver.

### Hotplug USB FDD Support

A dummy FDD device is created that will be associated with the hotplugged FDD later. Auto option creates this dummy device only if there is no USB FDD present.

## >>> USB Mass Storage Device Configuration

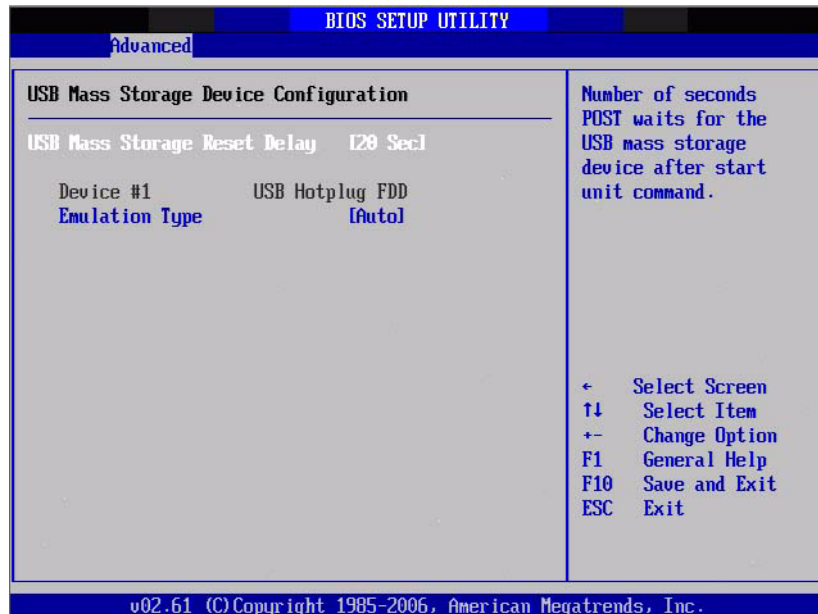

Figure 3.19 USB Mass storage Device Configuration

### USB Mass Storage Reset Delay

Number of sends POST wait for the USB mass storage device after start unit command.

### Emulation Type

If Auto, USB devices less than 530MB will be emulated as Floppy and remaining as hard drive. Force FDD option can be used to force a FDD formatted drive to boot as FDD(Ex. ZIP drive).

## 3.4 Advanced PCI/PnP Settings

Select the PCI/PnP tab from the PCM-9562 setup screen to enter the Plug and Play BIOS Setup screen. You can display a Plug and Play BIOS Setup option by highlighting it using the <Arrow> keys. All Plug and Play BIOS Setup options are described in this section. The Plug and Play BIOS Setup screen is shown below.

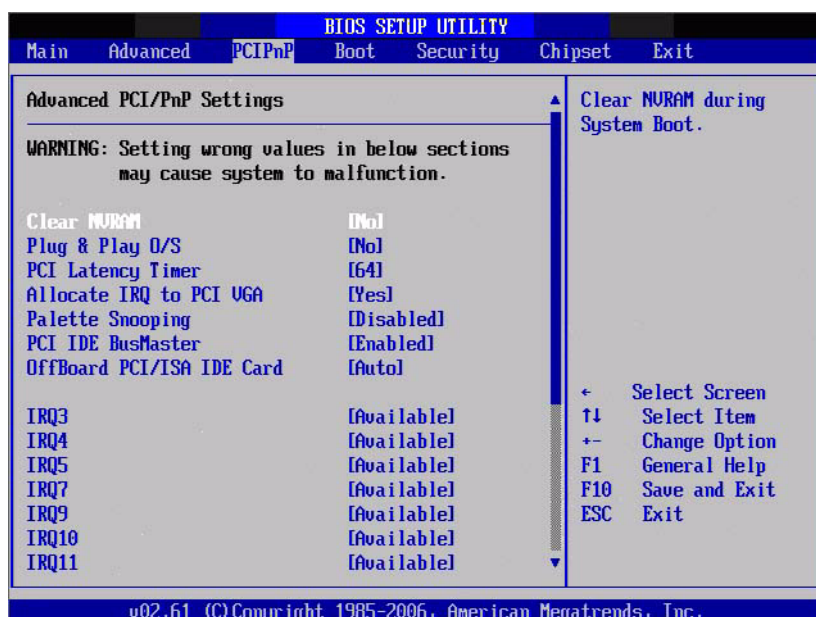

Figure 3.20 PCI/PNP Setup (top)

### Clear NVRAM

Set this value to force the BIOS to clear the Non-Volatile Random Access Memory (NVRAM). The Optimal and Fail-Safe default setting is No.

### Plug & Play O/S

When set to No, BIOS configures all the device in the system. When set to Yes and if you install a Plug and Play operating system, the operating system configures the Plug and Play device not required for boot.

### PCI Latency Timer

Value in units of PCI clocks for PCI device latency timer register.

### Allocate IRQ to PCI VGA

When set to Yes will assigns IRQ to PCI VGA card if card requests IRQ. When set to No will not assign IRQ to PCI VGA card even if card requests an IRQ.

### Palette Snooping

This item is designed to solve problems caused by some non-standard VGA card.

### PCI IDE BusMaster

When set to enabled BIOS uses PCI busmastering for reading/writing to IDE drives.

### OffBoard PCI/ISA IDE Card

Some PCI IDE cards may require this to be set to the PCI slot number that is holding the card. When set to Auto will works for most PCI IDE cards.

### IRQ3 / 4 / 5 / 7 / 9 / 10 / 11

This item allows you respectively assign an interruptive type for IRQ-3, 4, 5, 7, 9, 10, 11.

### DMA Channel0 / 1 / 3 / 5 / 6 / 7

When set to Available will specified DMA is available to be used by PCI/PnP devices. When set to Reserved will specified DMA will Reserved for use by legacy ISA devices.

### Reserved Memory Size

This item allows you to reserved size of memory block for legacy ISA device.

## 3.5 Boot Settings

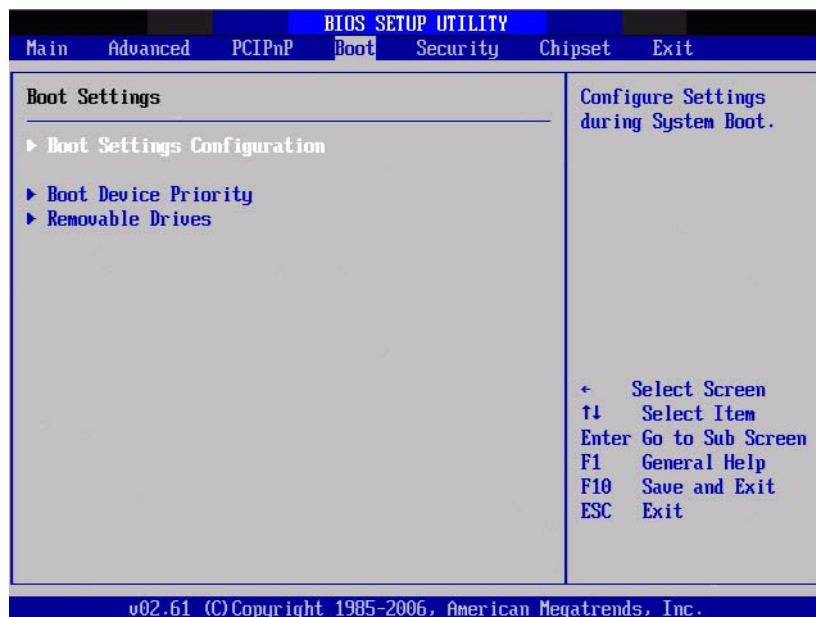

Figure 3.21 Boot Setup Utility

### 3.5.1 Boot settings Configuration

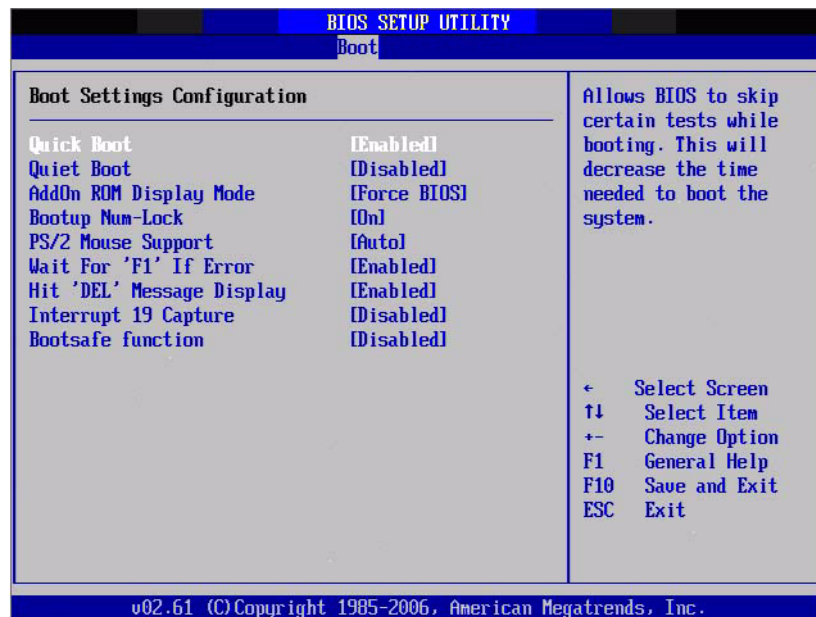

Figure 3.22 Boot Setting Configuration

#### Quick Boot

This item allows BIOS to skip certain tests while booting. This will decrease the time needed to boot the system.

#### Quiet Boot

If this option is set to Disabled, the BIOS displays normal POST messages. If Enabled, an OEM Logo is shown instead of POST messages.

#### AddOn ROM Display Mode

Set display mode for option ROM.

#### Bootup Num-Lock



Select the Power-on state for Numlock.

### PS/2 Mouse Support

Select support for PS/2 Mouse.

### Wait For “F1” If Error

Wait for the F1 key to be pressed if an error occurs.

### Hit “DEL” Message Display

Displays “Press DEL to run Setup” in POST.

### Interrupt 19 Capture

This item allows option ROMs to trap interrupt 19.

### Bootsafe function

This item allows you to enable or disable the bootsafe function.

## 3.6 Security Setup



**Figure 3.23 Password Configuration**

Select Security Setup from the PCM-9562 Setup main BIOS setup menu. All Security Setup options, such as password protection and virus protection are described in this section. To access the sub menu for the following items, select the item and press <Enter>:

### Change Supervisor / User Password

**Boot sector Virus protection:** The boot sector virus protection will warn if any program tries to write to the boot sector.

## 3.7 Advanced Chipset Settings



Figure 3.24 Advanced Chipset Settings

### 3.7.1 North Bridge Chipset Configuration

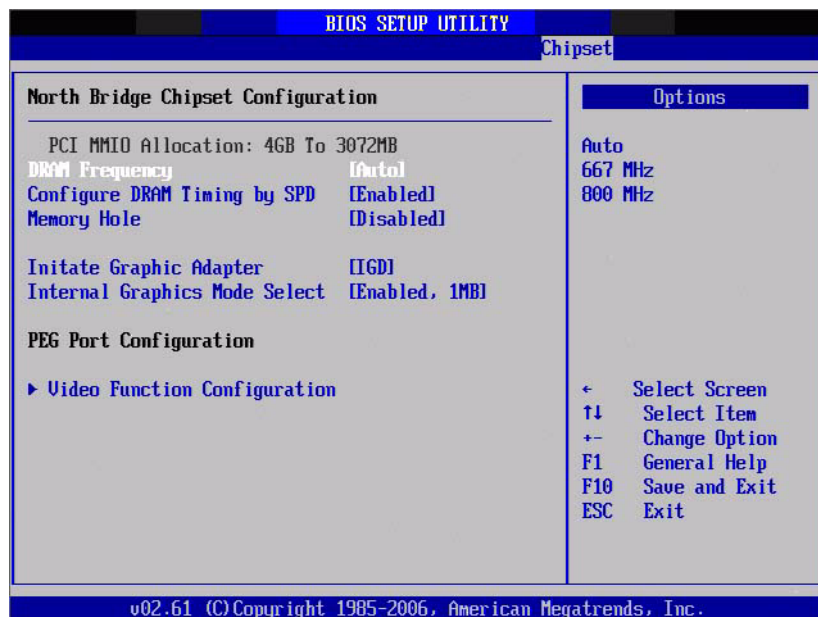

Figure 3.25 North Bridge Configuration

#### DRAM Frequency

This item allows you to manually changed DRAM frequency.

#### Configure DRAM Timing by SPD

This item allows you to enables or disables detect by DRAM SPD.

#### Memory Hole

This item allows you to free 15MB-16MB of memory size for some ISA devices.

#### Initiate Graphic Adapter

This item allows you to select which graphics controller to use as the primary boot device.



Internal Graphics Mode Select: Select the amount of system memory used by the Internal graphics device.



**Figure 3.26 Video function configuration**

#### **DVMT Mode Select**

Displays the active system memory mode.

#### **DVMT/FIXED Memory**

Specify the amount of DVMT / FIXED system memory to allocate for video memory.

#### **Boot Display Device**

Select boot display device at post stage.

#### **Flat Panel Type**

This item allows you to select which panel resolution you wants.

#### **Spread Spectrum Clock**

This item allows you to enables or disables spread spectrum clock.

## 3.7.2 South Bridge Chipset Configuration

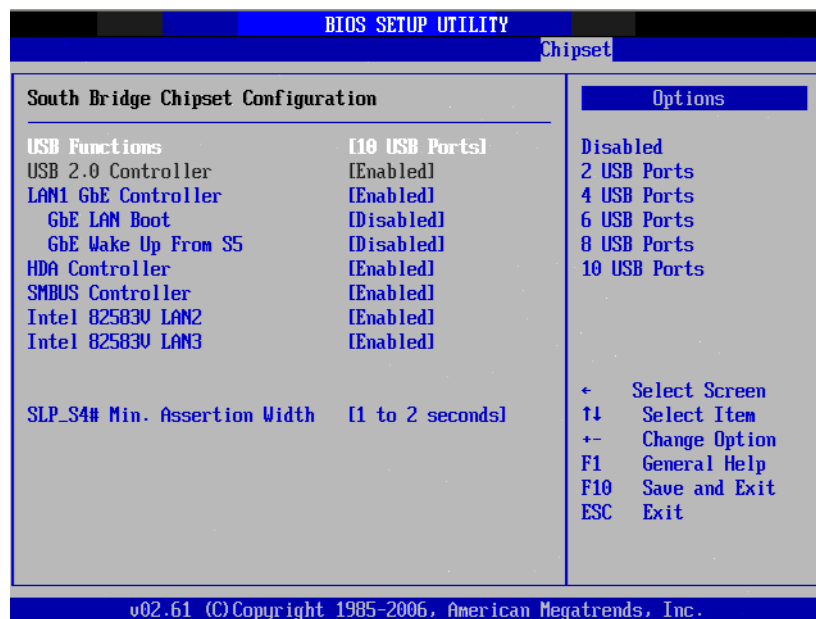

Figure 3.27 South Bridge Configuration

### USB Functions

Disabled, 2 USB Ports, 4 USB Ports, 6 USB Ports or 8 USB Ports.

### USB 2.0 Controller

Enables or disables the USB 2.0 controller.

### LAN1 GbE controller

Enables or disables the GbE controller.

### GbE LAN Boot

Enables or disables LAN boot.

### GbE Wake Up From S5

Enables or disables GbE wake up from S5 function.

### HDA Controller

Enables or disables the HDA controller.

### SMBUS Controller

Enables or disables the SMBUS controller.

### Intel 82583V LAN2 / LAN3

Enables or disables the GbE1 /GbE2 controller.

### Intel 82583V LAN BootROM

Enables or disables Intel 828583V LAN boot.

### SLP\_S4# Min. Assertion Width

This item allows you to set a delay of sorts.

## 3.8 Exit Option

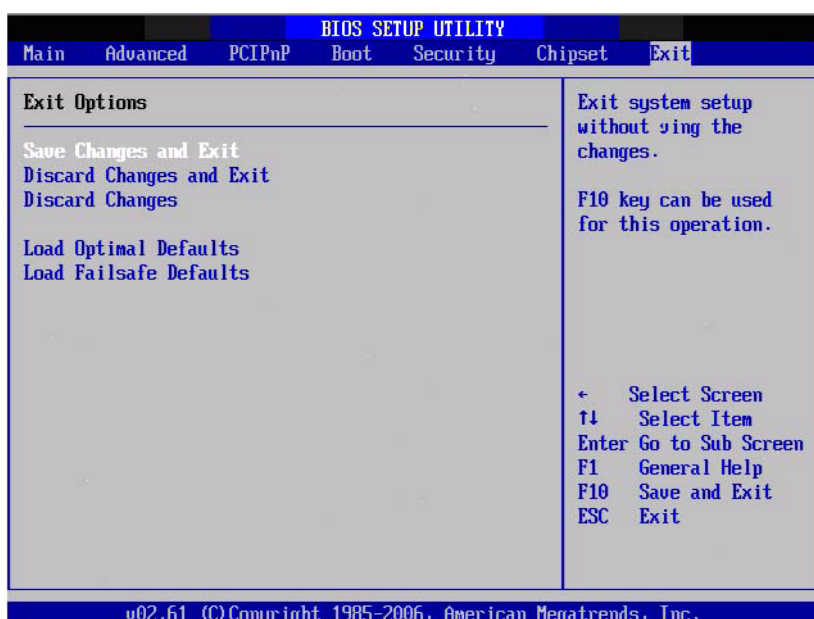

Figure 3.28 Exit Option

### 3.8.1 Save Changes and Exit

When you have completed system configuration, select this option to save your changes, exit BIOS setup and reboot the computer so the new system configuration parameters can take effect.

1. Select Exit Saving Changes from the Exit menu and press <Enter>. The following message appears: Save Configuration Changes and Exit Now? [Ok] [Cancel]
2. Select Ok or cancel.

### 3.8.2 Discard Changes and Exit

Select this option to quit Setup without making any permanent changes to the system configuration.

1. Select Exit Discarding Changes from the Exit menu and press <Enter>. The following message appears: Discard Changes and Exit Setup Now? [Ok] [Cancel]
2. Select Ok to discard changes and exit. Discard Changes
3. Select Discard Changes from the Exit menu and press <Enter>.

### 3.8.3 Load Optimal Defaults

The PCM-9562 automatically configures all setup items to optimal settings when you select this option. Optimal Defaults are designed for maximum system performance, but may not work best for all computer applications. In particular, do not use the Optimal Defaults if your computer is experiencing system configuration problems. Select Load Optimal Defaults from the Exit menu and press <Enter>.

### 3.8.4 Load Fail-Safe Defaults

The PCM-9562 automatically configures all setup options to fail-safe settings when you select this option. Fail-Safe Defaults are designed for maximum system stability, but not maximum performance. Select Fail-Safe Defaults if your computer is experiencing system configuration problems.

- 
1. Select Load Fail-Safe Defaults from the Exit menu and press <Enter>. The following message appears: Load Fail-Safe Defaults? [OK] [Cancel]
  2. Select OK to load Fail-Safe defaults.

# Chapter 4

Software Introduction  
& Installation

---

## 4.1 S/W Introduction

The mission of Advantech Embedded Software Services is to "Enhance quality of life with Advantech platforms and Microsoft Windows® embedded technology." We enable Windows® Embedded software products on Advantech platforms to more effectively support the embedded computing community. Customers are freed from the hassle of dealing with multiple vendors (hardware suppliers, system integrators, embedded OS distributors) for projects. Our goal is to make Windows® Embedded Software solutions easily and widely available to the embedded computing community.

## 4.2 Driver Installation

### 4.2.1 Windows XP Professional

To install the drivers for Windows XP Professional, insert the CD into the CD-Rom, it will auto-detect the hardware platform and then pop up with the "Embedded Computing Install Wizard" box; just select the drivers that you want to install then click "Install All Selected Drivers". Follow the Driver Setup Wizard instructions; click "Next" to complete the installation.

### 4.2.2 Other OS

To install the drivers for another Windows OS or Linux, please browse the CD to run the setup file under each chipset folder on the CD-ROM.

## 4.3 Value-Added Software Services

### 4.3.1 SUSI Introduction

To make hardware easier and convenient to access for programmers, Advantech has released a suite of API (Application Programming Interface) in the form of a program library. The program Library is called Secured and Unified Smart Interface or SUSI for short.

In modern operating systems, user space applications cannot access hardware directly. Drivers are required to access hardware. User space applications access hardware through drivers. Different operating systems usually define different interface for drivers. This means that user space applications call different functions for hardware access in different operating systems. To provide a uniform interface for accessing hardware, an abstraction layer is built on top of the drivers and SUSI is such an abstraction layer. SUSI provides a uniform API for application programmers to access the hardware functions in different Operating Systems and on different Advantech hardware platforms.

Application programmers can invoke the functions exported by SUSI instead of calling the drivers directly. The benefit of using SUSI is portability. The same set of API is defined for different Advantech hardware platforms. Also, the same set of API is implemented in different Operating Systems including Windows XP and Windows CE. This user's manual describes some sample programs and the API in SUSI. The hardware functions currently supported by SUSI can be grouped into a few categories including Watchdog, I<sup>2</sup>C, SMBus, GPIO, and VGA control. Each category of API in SUSI is briefly described below.

## 4.3.2 Software APIs

### 4.3.2.1 The GPIO API

General Purpose Input/Output is a flexible parallel interface that allows a variety of custom connections. It allows users to monitor the level of signal input or set the output status to switch on/off a device. Our API also provides Programmable GPIO, which allows developers to dynamically set the GPIO input or output status.

### 4.3.2.2 The I<sup>2</sup>C API

I<sup>2</sup>C is a bi-directional two-wire bus that was developed by Philips for use in their televisions in the 1980s and nowadays is used in various types of embedded systems. The strict timing requirements defined in the I<sup>2</sup>C protocol has been taken care of by SUSI. Instead of asking application programmers to figure out the strict timing requirements in the I<sup>2</sup>C protocol, the I<sup>2</sup>C API in SUSI can be used to control I<sup>2</sup>C devices by invoking other function calls. SUSI provides a consistent programming interface for different Advantech boards. That means user programs using SUSI are portable among different Advantech boards as long as the boards and SUSI provide the required functionalities. Overall product development times can be greatly reduced using SUSI.

### 4.3.2.3 The SMBus API

The System Management Bus (SMBus) is a two-wire interface defined by Intel® Corporation in 1995. It is based on the same principles of operation of I<sup>2</sup>C and is used in personal computers and servers for low-speed system management communications. Nowadays, it can be seen in many types of embedded systems. As with other API in SUSI, the SMBus API is available on many platforms including Windows XP and Windows CE.

### 4.3.2.4 The Display Control API

There are two kinds of VGA control APIs, backlight on/off control and brightness control. Backlight on/off control allows a developer to turn on or off the backlight, and to control brightness smoothly.

1. Brightness Control
  - The Brightness Control API allows a developer to interface with an embedded device to easily control brightness.
2. Backlight Control
  - The Backlight API allows a developer to control the backlight (screen) on/off in an embedded device.

### 4.3.2.5 The Watchdog API

A watchdog timer (abbreviated as WDT) is a hardware device which triggers an action, e.g. rebooting the system, if the system does not reset the timer within a specific period of time. The WDT API in SUSI provides developers with functions such as starting the timer, resetting the timer, and setting the timeout value if the hardware requires customized timeout values.

### 4.3.2.6 The Hardware Monitor API

The hardware monitor (abbreviated as HWM) is a system health supervision capability achieved by placing certain I/O chips along with sensors for inspecting the target of interests for certain condition indexes, such as fan speed, temperature and voltage etc.

However, due to the inaccuracy among many commercially available hardware monitoring chips, Advantech has developed a unique scheme for hardware monitoring -

---

achieved by using a dedicated micro-processor with algorithms specifically designed for providing accurate, real-time and reliable data content; helping protect your system in a more reliable manner.

#### **4.3.2.7 The Power Saving API**

1. CPU Speed
  - Make use of Intel SpeedStep technology to reduce power consumption. The system will automatically adjust the CPU Speed depending on system loading.
2. System Throttling
  - Refers to a series of methods for reducing power consumption in computers by lowering the clock frequency. APIs allow the user to lower the clock from 87.5% to 12.5%.

### **4.3.3 SUSI Utilities**

#### **4.3.3.1 BIOS Flash**

The BIOS Flash utility allows customers to update the flash ROM BIOS version, or use it to back up current BIOS by copying it from the flash chip to a file on customers'disk. The BIOS Flash utility also provides a command line version and API for fast implementation into customized applications.

#### **4.3.3.2 Embedded Security ID**

The embedded application is the most important property of a system integrator. It contains valuable intellectual property, design knowledge and innovation, but it is easily copied! The Embedded Security ID utility provides reliable security functions for customers to secure their application data within embedded BIOS.

#### **4.3.3.3 Monitoring utility**

The Monitoring utility allows the customer to monitor system health, including voltage, CPU and system temperature and fan speed. These items are important to a device; if critical errors happen and are not solved immediately, permanent damage may be caused.

#### **4.3.3.4 eSOS**

The eSOS is a small OS stored in BIOS ROM. It will boot up in case of a main OS crash. It will diagnose the hardware status, and then send an e-mail to a designated administrator. The eSOS also provides remote connection: Telnet server and FTP server, allowing the administrator to rescue the system.

#### **4.3.3.5 Flash Lock**

Flash Lock is a mechanism that binds the board and CF card (SQFlash) together. The user can "Lock" SQFlash via the Flash Lock function and "Unlock" it via BIOS while booting. A locked SQFlash cannot be read by any card reader or boot from other platforms without a BIOS with the "Unlock" feature.

### **4.3.4 SUSI Installation**

SUSI supports many different operating systems. Each subsection below describes how to install SUSI and related software on a specific operating system. Please refer to the subsection matching your operating system.

#### **4.3.4.1 Windows XP**

In windows XP, you can install the library, drivers and demo programs onto the platform easily using the installation tool--The SUSI Library Installer. After the installer



has executed, the SUSI Library and related files for Windows XP can be found in the target installation directory. The files are listed in the following table.

Directory	Contents
\Library	<ul style="list-style-type: none"> <li>■ Susi.lib Library for developing the applications on Windows XP.</li> <li>■ Susi.dll Dynamic library for SUSI on Windows XP.</li> </ul>
\Demo	<ul style="list-style-type: none"> <li>■ SusiDemo.EXE Demo program on Windows XP.</li> <li>■ Susi.dll Dynamic library for SUSI on Windows XP.</li> </ul>
\Demo\SRC	Source code of the demo program on Windows XP.

The following section illustrates the installation process.

**Note!** *The version of the SUSI Library Installer shown on each screen shot below depends on your own particular version.*



1. Extract Susi.zip.
2. Double-click the "Setup.exe" file.

The installer searches for a previous installation of the SUSI Library. If it locates one, a screen shot opens asking whether you want to modify, repair or remove the software. If a previous version is located, please see the section of [Maintenance Setup]. If it is not located, the following screen shot opens. Click Next.

#### 4.3.4.2 Windows CE

In windows CE, there are three ways to install the SUSI Library, you can install it manually or use Advantech CE-Builder to install the library or just copy the programs and the library onto a compact flash card.

##### Express Installation:

You can use Advantech CE-Builder to load the library into the image.

- First, you click the My Component tab.
- In this tab, you click Add New Category button to add a new category, eg. the SUSI Library.
- Then you can add a new file in this category, and upload the SUSI.dll for this category.
- After these steps, you can select the SUSI Library category you created for every project.

##### Manual Installation:

You can add the SUSI Library into the image by editing any bib file.

First you open project.bib in the platform builder.

- Add this line to the MODULES section of project.bib  
Susi.dll \$(\_FLATRELEASEDIR)\Susi.dll NK SH

- If you want to run the window-based demo, add following line:  
SusiTest.exe \$( \_FLATRELEASEDIR)\SusiTest.exe
- If you want to run the console-based demo, add following lines:  
Watchdog.exe \$( \_FLATRELEASEDIR)\Watchdog.exe NK S  
GPIO.exe \$( \_FLATRELEASEDIR)\GPIO.exe NK S  
SMBUS.exe \$( \_FLATRELEASEDIR)\SMBUS.exe NK S
- Place the three files into any files directory.
- Build your new Windows CE operating system.

### 4.3.5 SUSI Sample Programs

#### Sample Programs

The sample programs demonstrate how to incorporate SUSI into your program. There are sample programs for two categories of operating system, i.e. Windows XP and Windows CE. The sample programs run in graphics mode in Windows XP and Windows CE. The sample programs are described in the subsections below.

#### Windows Graphics Mode

There are sample programs of Windows in graphics mode for two categories of operating system, i.e. Windows CE and Windows XP. Each demo application contains an executable file SusiDemo.exe, a shared library Susi.dll and source code within the release package. The files of Windows CE and Windows XP are not compatible with each other.

SusiDemo.exe is an executable file and it requires the shared library, Susi.dll, to demonstrate the SUSI functions. The source code of SusiDemo.exe also has two versions, i.e. Windows CE and Windows XP, and must be compiled under Microsoft Visual C++ 6.0 on Windows XP or under Microsoft Embedded Visual C++ 4.0 on Windows CE. Developers must add the header file Susi.h and library Susi.lib to their own projects when they want to develop something with SUSI.

#### SusiDemo.exe

The SusiDemo.exe test application is an application which uses all functions of the SUSI Library. It has five major function blocks: Watchdog, GPIO, SMBus, I<sup>2</sup>C and VGA control. The following screen shot appears when you execute SusiDemo.exe. You can click function tabs to select test functions respectively. Some function tabs will not show on the test application if your platform does not support such functions. For a complete support list, please refer to Appendix A. We describe the steps to test all functions of this application.

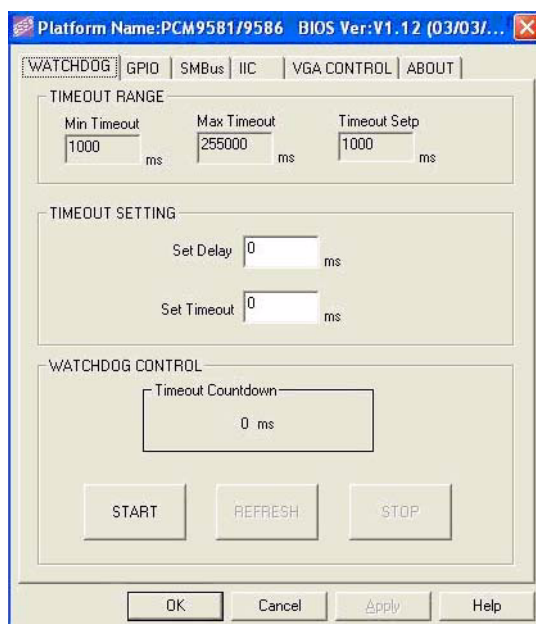

## GPIO

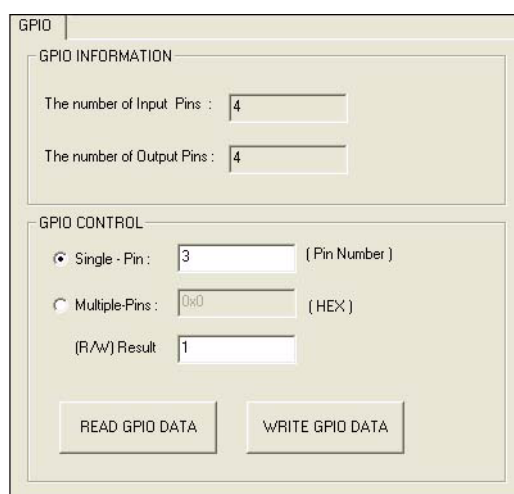

When the application is executed, it will display GPIO information in the GPIO INFORMATION group box. It displays the number of input pins and output pins. You can click the radio button to choose to test either the single pin function or multiple pin functions. The GPIO pin assignments of the supported platforms are located in Appendix B.

- Test Read Single Input Pin
  - Click the radio button- Single-Pin.
  - Key in the pin number to read the value of the input pin. The Pin number starts from '0'.
  - Click the READ GPIO DATA button and the status of the GPIO pin will be displayed in (R/W) Result field.
- Test Read Multiple Input Pin
  - Click the radio button- Multiple-Pins.
  - Key in the pin number from '0x01' to '0x0F' to read the value of the input pin. The pin numbers are ordered bitwise, i.e. bit 0 stands for GPIO 0, bit 1 stands

for GPIO 1, etc. For example, if you want to read pin 0, 1, and 3, the pin numbers should be '0x0B'.

- Click READ GPIO DATA button and the statuses of the GPIO pins will be displayed in (R/W) Result field.

#### ■ Test Write Single Output Pin

- Click the radio button- Single-Pin.
- Key in the pin numbers you want to write. Pin numbers start from '0'.
- Key in the value either '0' or '1' in (R/W) Result field to write the output pin you chose above step.
- Click the WRITE GPIO DATA button to write the GPIO output pin.

#### ■ Test Write Multiple Output Pins

- Click the radio button- Multiple-Pins.
- Key in the pin number from '0x01' to '0x0F' to choose the multiple pin numbers to write the value of the output pin. The pin numbers are ordered bitwise, i.e. bit 0 stands for GPIO 0, bit 1 stands for GPIO 1, etc. For example, if you want to write pin 0, 1, and 3, the pin numbers should be '0x0B'.
- Key in the value in (R/W) Result field from '0x01' to '0x0F' to write the value of the output pin. The pin numbers are ordered bitwise, i.e. bit 0 stands for GPIO 0, bit 1 stands for GPIO 1, etc. For example, if you want to set pin 0 and 1 high, 3 to low, the pin number should be '0x0B', and then you should key in the value '0x0A' to write.
- Click the WRITE GPIO DATA button to write the GPIO output pins.

## I<sup>2</sup>C

The screenshot shows a software interface titled "I2C CONTROL". It contains three input fields: "Slave address" with the value "0x0 (Hex)", "Register Offset" with the value "0x0 (Hex)", and "Result" with the value "0x0 (Hex)". Below these fields are two buttons: "READ A BYTE" and "WRITE A BYTE".

When the application is executed, you can read or write a byte of data through I<sup>2</sup>C devices. All data must be read or written in hexadecimal system.

#### ■ Read a byte

- Key in the slave device address in Slave address field.
- Key in the register offset in Register Offset field.
- Click the READ A BYTE button and then a byte of data from the device will be shown on the Result field.

#### ■ Write a byte

- Key in the slave device address in Slave address field.
- Key in the register offset in Register Offset field.
- Key in the desirous of data in Result field to write to the device.
- Click the WRITE A BYTE button and then the data will be written to the device through I<sup>2</sup>C.

## SMBus

When the application has executed, you can click the radio button to choose to test each access mode, i.e. Access a byte, Access multiple bytes and Access a word. All data must be read or written in hexadecimal except the numbers for radio button: Access multiple bytes mode must be written in decimal. You can test the functionalities of the watchdog as follows:

- Read a byte
  - Click the radio button- Access a byte.
  - Key in the slave device address in the Slave address field.
  - Key in the register offset in the Register Offset field.
  - Click the READ SMBus DATA button and a byte of data from the device will be shown on the Result field.
  
- Write a byte
  - Click the radio button- Access a byte.
  - Key in the slave device address in Slave address field.
  - Key in the register offset in Register Offset field.
  - Key the desired data in the Result field to write to the device.
  - Click the WRITE SMBus DATA button and then the data will be written to the device through SMBus.
  
- Read a word
  - Click the radio button- Access a word.
  - Key in the slave device address in the Slave address field.
  - Key in the register offset in the Register Offset field.
  - Click the READ SMBus DATA button and then a word of data from the device will be shown on the Result field.
  
- Write a word
  - Click the radio button- Access a word.
  - Key in the slave device address in the Slave address field.
  - Key in the register offset in the Register Offset field.
  - Key in the desired data, such as 0x1234, in the Result field to write to the device.
  - Click the WRITE SMBus DATA button and the data will be written to the device through the SMBus.

- Read Multiple bytes
  - Click the radio button- Access multiple bytes.
  - Key in the slave device address in the Slave address field.
  - Key in the register offset in the Register Offset field.
  - Key in the desired number of bytes, such as 3, in the right side field of radio button- Access multiple bytes. The number must be written in decimal.
  - Click the READ SMBus DATA button and then all data from the device will be divided from each other by commas and be shown in the Result field.
  
- Write Multiple bytes
  - Click the radio button- Access multiple bytes.
  - Key in the slave device address in the Slave address field.
  - Key in the register offset in the Register Offset field.
  - Key in the desired number of bytes, such as 3, in the right side field of the radio button- Access multiple bytes. The number must be written in decimal.
  - Key in all the desired data in the Result field in hexadecimal format, divided by commas, for example, 0x50,0x60,0x7A.
  - Click the WRITE SMBus DATA button and all of the data will be written to the device through the SMBus.

## Display Control

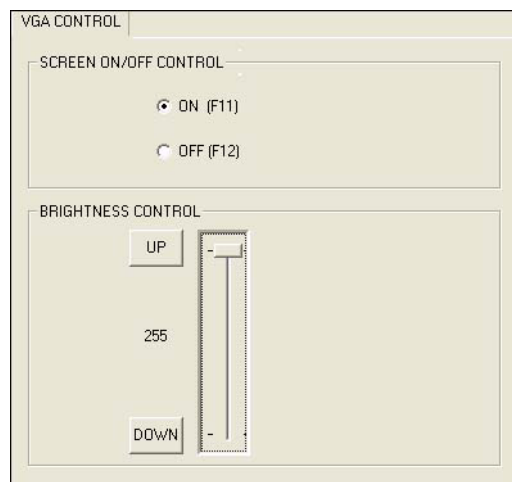

When the application is executed, it will display two blocks of VGA control functions. The application can turn on or turn off the screen shot freely, and it also can tune the brightness of the panels if your platform is being supported. You can test the functionalities of VGA control as follows:

- Screen on/off control
  - Click the radio button ON or push the key F11 to turn on the panel screen.
  - Click the radio button OFF or push the key F12 to turn off the panel screen.
  - The display chip of your platform must be in the support list in Appendix A, or this function cannot work.
  
- Brightness control
  - Move the slider in increments, using either the mouse or the direction keys, or click the UP button to increase the brightness.
  - Move the slider in decrements, using either the mouse or the direction keys, or click the DOWN button to decrease the brightness.

## Watchdog

When the application is executed, it will display watchdog information in the WATCHDOG INFORMATION group box. It displays max timeout, min timeout, and timeout steps in milliseconds. For example, a 1~255 seconds watchdog will have 255000 max timeout, 1000 min timeout, and 1000 timeout steps. You can test the functionality of the watchdog as follows:

- Set the timeout value 3000 (3 sec.) in the SET TIMEOUT field and set the delay value 2000 (2 sec.) in the SET DELAY field, then click the START button. The Timeout Countdown field will countdown the watchdog timer and display 5000 (5 sec.).
- Before the timer counts down to zero, you can reset the timer by clicking the REFRESH button. After you click this button, the Timeout Countdown field will display the value of the SET TIMEOUT field.
- If you want to stop the watchdog timer, you just click the STOP button.

## Hardware Monitor

CL

When the Monitor application is executed by clicking the button, hardware monitoring data values will be displayed. If certain data values are not supported by the platform, the correspondent data field will be grayed-out with a value of 0.

---

For a more detailed PCM-9562 software API user manual, please contact your dealer or Advantech AE. We also include these manuals on the bundled CD.



# Chapter 5

Extension I/O  
Installation

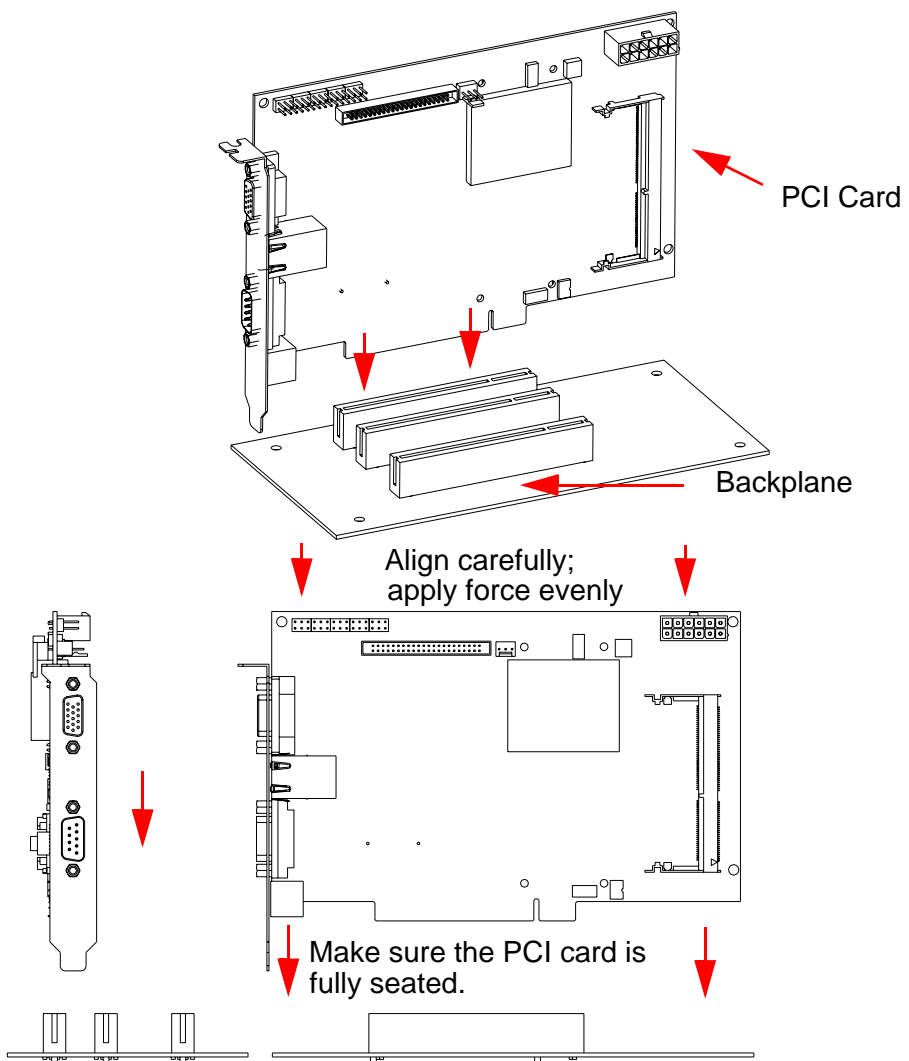
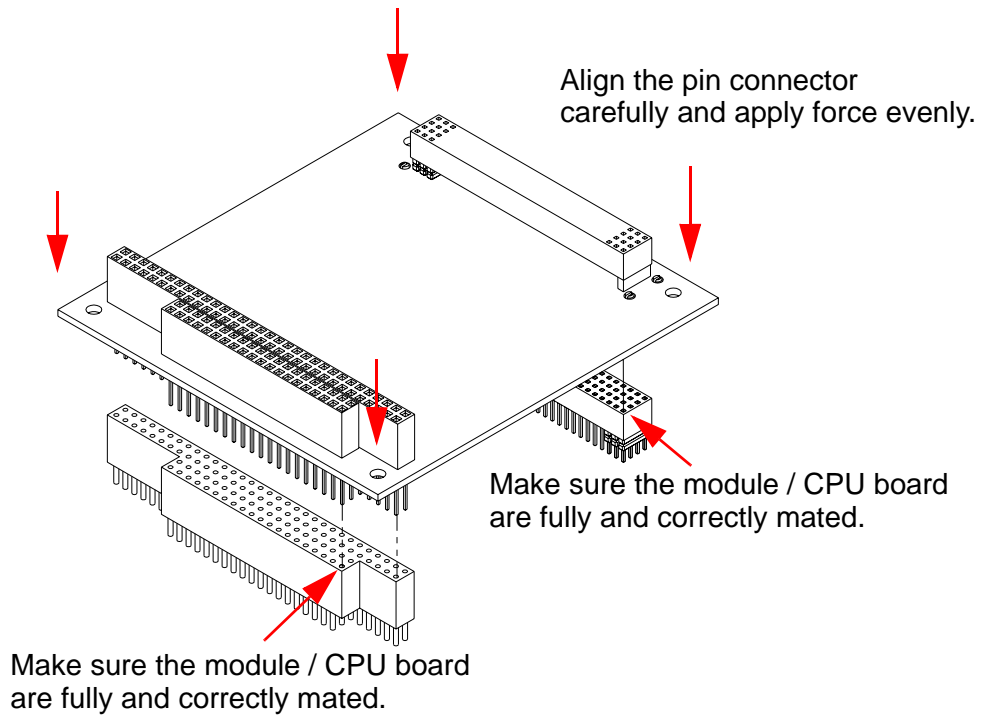

# Appendix **A**

## Pin Assignments

## CN1: DDR2 SODIMM Socket

<b>CN1</b>	<b>DDR2 SODIMM Socket</b>
<b>Part Number</b>	1651000087
<b>Footprint</b>	DDR-SODIMM-STD65
<b>Description</b>	SKT DIMM 200P DDR2 H=6.5mm STD SMD WO/Pb

## CN2: Audio CD-In Connector



<b>CN2</b>	<b>CD In Connector</b>
<b>Part Number</b>	1655304020
<b>Footprint</b>	WF_4P_79_BOX_R1_D
<b>Description</b>	WAFER BOX 2.0mm 4P 180D(M) W/LOCK A2001WV2-4P
<b>Pin</b>	<b>Pin Name</b>
1	CD In Right
2	GND
3	GND
4	CD In Left

## CN4: Audio Connector

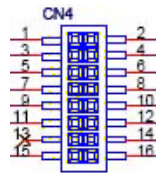

<b>CN4</b>	<b>Audio Connector</b>
<b>Part Number</b>	1653208260
<b>Footprint</b>	BH8X2SV
<b>Description</b>	BOX HEADER 8*2P 180D(M) 2.00mm
<b>Pin</b>	<b>Pin Name</b>
1	Speaker Out R+
2	Speaker Out R-
3	Speaker Out L+
4	Speaker Out L-
5	Line Out Right
6	Line Out Left
7	AGND
8	AGND
9	Line In Right
10	Line In Left
11	AGND
12	AGND
13	NC
14	MIC2 In
15	MIC1 In
16	AGND

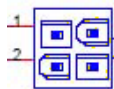
**CN5: Power Connector**

<b>CN5</b>	<b>Power Connector</b>
<b>Part Number</b>	1655404090
<b>Footprint</b>	ATXCON-2X6V-42
<b>Description</b>	Power CONN.6*2P 180D(M) DIP W/Fixed Lock
<b>Pin</b>	<b>Pin Name</b>
1	GND
2	GND
3	+12V
4	+12V

**CN6: Inverter Connector**

<b>CN6</b>	<b>Inverter Connector</b>
<b>Part Number</b>	1655000453
<b>Footprint</b>	WHL5V-2M
<b>Description</b>	WAFER BOX 2.0mm 5P 180D MALE W/LOCK
<b>Pin</b>	<b>Pin Name</b>
1	+12 V
2	GND
3	LVDS1_BKLTEN
4	LVDS1_VBR
5	+5 V

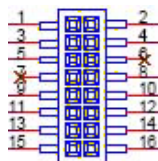
**CN8: VGA Connector**

<b>CN8</b>	<b>VGA Connector</b>
<b>Part Number</b>	1653208260
<b>Footprint</b>	BH8X2SV
<b>Description</b>	BOX HEADER 8*2P 180D(M) 2.00mm
<b>Pin</b>	<b>Pin Name</b>
1	Red
2	+5 V
3	GREEN
4	GND
5	BLUE

6	NC
7	NC
8	DDC Data
9	GND
10	HSYNC
11	GND
12	VSYNC
13	GND
14	DDC CLK
15	GND
16	GND

### CN9: LVDS Connector

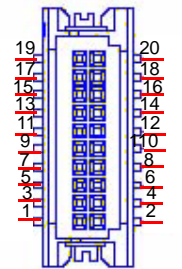

<b>CN9</b>	<b>LVDS Connector</b>
<b>Part Number</b>	1653910261
<b>Footprint</b>	SPH10X2
<b>Description</b>	*CONN. 20P 90D 1.25mm SMD WO/Pb DF13-20DP-1.25V
<b>Pin</b>	<b>Pin Name</b>
1	GND
2	GND
3	LVDS0_D0+
4	NC
5	LVDS0_D0-
6	NC
7	LVDS0_D1+
8	NC
9	LVDS0_D1-
10	NC
11	LVDS0_D2+
12	NC
13	LVDS0_D2-
14	NC
15	LVDS0_CLK+
16	NC
17	LVDS0_CLK-
18	NC
19	+5V or +3.3V
20	+5V or +3.3V

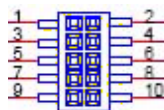
**CN10: GbE1 Connector**

<b>CN10</b>	<b>GbE1 Connector</b>
<b>Part Number</b>	1653205260
<b>Footprint</b>	BH5X2DV-2M
<b>Description</b>	BOX HEADER 5*2P 180D(M) 2.0mm DIP W/O Pb
<b>Pin</b>	<b>Pin Name</b>
1	GND
2	GND
3	GbE1_M3+
4	GbE1_M3-
5	GbE1_M2+
6	GbE1_M2-
7	GbE1_M1+
8	GbE1_M1-
9	GbE1_M0+
10	GbE1_M0-

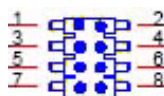
**CN11: GbE1,2 LED Connector**

<b>CN11</b>	<b>GbE1,2 LED Connector</b>
<b>Part Number</b>	1653004260
<b>Footprint</b>	JH4X2S-2M
<b>Description</b>	PIN HEADER 4*2P 180D(M) 2.0mm SMD
<b>Pin</b>	<b>Pin Name</b>
1	+3.3V
2	GND
3	GbE1_LINK100#
4	LAN2_LINK100#
5	GbE1_ACT#
6	LAN2_ACT#
7	GbE1_LINK1000#
8	LAN2_LINK1000#

## CN12: LAN2 Connector

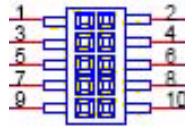

<b>CN12</b>	<b>LAN2 Connector</b>
<b>Part Number</b>	1653205260
<b>Footprint</b>	BH5X2DV-2M
<b>Description</b>	BOX HEADER 5*2P 180D(M) 2.0mm DIP W/O Pb
<b>Pin</b>	<b>Pin Name</b>
1	GND
2	GND
3	LAN2_M3+
4	LAN2_M3-
5	LAN2_M2+
6	LAN2_M2-
7	LAN2_M1+
8	LAN2_M1-
9	LAN2_M0+
10	LAN2_M0-

## CN13: HDD LED and POWER LED Connector

<b>CN13</b>	<b>HDD LED and POWER LED</b>
<b>Part Number</b>	1653003260
<b>Footprint</b>	JH3X2S-2M
<b>Description</b>	PIN HEADER 3*2P 180D(M) 2.0mm SMD SQUARE PIN
<b>Pin</b>	<b>Pin Name</b>
1	HWM LED+
2	HWM LED-
3	Power LED+
4	HDD LED+
5	Power LED-
6	HDD_LED-

## CN14: LAN3 Connector

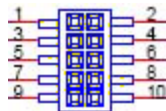

<b>CN14</b>	<b>LAN3 Connector</b>
<b>Part Number</b>	1653205260
<b>Footprint</b>	BH5X2DV-2M
<b>Description</b>	BOX HEADER 5*2P 180D(M) 2.0mm DIP W/O Pb
<b>Pin</b>	<b>Pin Name</b>
1	GND
2	GND

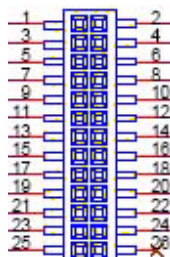

3	LAN3_M3+
4	LAN3_M3-
5	LAN3_M2+
6	LAN3_M2-
7	LAN3_M1+
8	LAN3_M1-
9	LAN3_M0+
10	LAN3_M0-

**CN15: LPT / FDD Connector**

<b>CN15</b>	<b>LPT / FDD Connector</b>
<b>Part Number</b>	1653213260
<b>Footprint</b>	BH13X2SV
<b>Description</b>	BOX HEADER 13*2P 180D(M) 2.0mm SMD
<b>Pin</b>	<b>Pin Name</b>
1	STB#
2	AFD#
3	D0
4	ERR#
5	D1
6	INIT#
7	D2
8	SLIN#
9	D3
10	GND
11	D4
12	GND
13	D5
14	GND
15	D6
16	GND
17	D7
18	GND
19	ACK#
20	GND
21	BUSY
22	GND
23	PE
24	GND
25	SLCT
26	NC

## CN16: Standby Power Connector



<b>CN16</b>	<b>Standby Power Connector</b>
<b>Part Number</b>	1655303020
<b>Footprint</b>	WHL3V-2M
<b>Description</b>	WAFER BOX 2.0mm 3P 180D w/LOCK
<b>Pin</b>	<b>Pin Name</b>
1	+5VSB
2	GND
3	PS_ON#

\*For AT mode support, default with Jumper on CN16(1-2)

## CN17: PC-104/+ Connector

<b>CN17</b>	<b>PC-104/+ Connector</b>
<b>Part Number</b>	1653130428, 165313222A, 165312022A
<b>Footprint</b>	PCI-PLUS
<b>Description</b>	PCB SKT 30*4 180D(F)PC/104+ SOLDER WO/Pb EPT

## CN18: LAN3 LED Connector

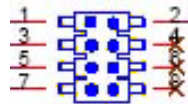

<b>CN18</b>	<b>LAN3 LED Connector</b>
<b>Part Number</b>	1653004260
<b>Footprint</b>	JH4X2S-2M
<b>Description</b>	PIN HEADER 4*2P 180D(M) 2.0mm SMD
<b>Pin</b>	<b>Pin Name</b>
1	+3.3V
2	GND
3	LAN3_LINK100#
4	NC
5	LAN3_ACT#
6	NC
7	LAN3_LINK1000#
8	NC

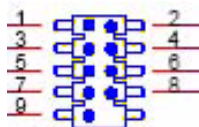
**CN20: USB1/2 Connector**

<b>CN20</b>	<b>USB1/2 Connector</b>
<b>Part Number</b>	1653005260
<b>Footprint</b>	HD_5x2P_79_BOX_N10
<b>Description</b>	PIN HEADER 5x2P 180D(M) 2.0mm SMD IDIOT-PROOF
<b>Pin</b>	<b>Pin Name</b>
1	+5V Dual
2	+5V Dual
3	USB1_P-
4	USB2_P-
5	USB1_P+
6	USB2_P+
7	GND
8	GND
9	GND

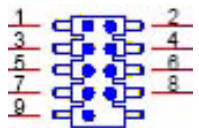
**CN21: USB3/4 Connector**

<b>CN21</b>	<b>USB3/4 Connector</b>
<b>Part Number</b>	1653005260
<b>Footprint</b>	HD_5x2P_79_BOX_N10
<b>Description</b>	PIN HEADER 5x2P 180D(M) 2.0mm SMD IDIOT-PROOF
<b>Pin</b>	<b>Pin Name</b>
1	+5V Dual
2	+5V Dual
3	USB3_P-
4	USB4_P-
5	USB3_P+
6	USB4_P+
7	GND
8	GND
9	GND

## CN22: Reset Button Connector



<b>CN22</b>	<b>Reset Button Connector</b>
<b>Part Number</b>	1655302020
<b>Footprint</b>	WHL2V-2M
<b>Description</b>	WAFER BOX 2P 180D 2.0mm MALE W/Lock
<b>Pin</b>	<b>Pin Name</b>
1	RESET#
2	GND

## CN23: Power Button Connector



<b>CN23</b>	<b>Power Button Connector</b>
<b>Part Number</b>	1655302020
<b>Footprint</b>	WHL2V-2M
<b>Description</b>	WAFER BOX 2P 180D 2.0mm MALE W/Lock
<b>Pin</b>	<b>Pin Name</b>
1	PWRBTN#
2	GND

## CN24: SIR Connector

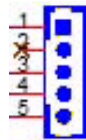

<b>CN24</b>	<b>SIR Connector</b>
<b>Part Number</b>	1655000453
<b>Footprint</b>	WHL5V-2M
<b>Description</b>	WAFER BOX 2.0mm 5P 180D(M) W/LOCK
<b>Pin</b>	<b>Pin Name</b>
1	+5V
2	NC
3	RXD
4	GND
5	TXD

### CN25: PS2 Keyboard/Mouse Connector



<b>CN25</b>	<b>PS2 Keyboard/Mouse Connector</b>
<b>Part Number</b>	1655306020
<b>Footprint</b>	WHL6V-2M
<b>Description</b>	WAFER BOX 2.0mm 6P 180D(M) W/LOCK
<b>Pin</b>	<b>Pin Name</b>
1	KBCLK
2	KBDAT
3	MSCLK
4	GND
5	+5V
6	MSDAT

### CN26: CF TYPEII Connector

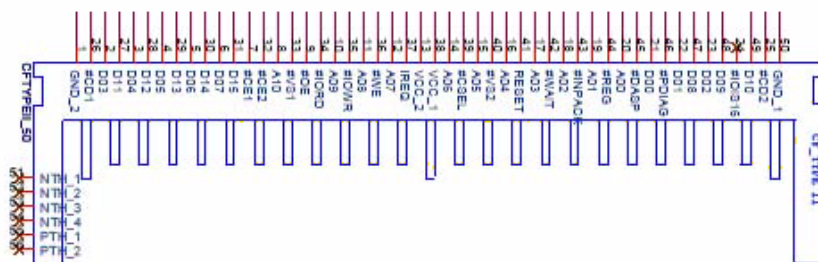

<b>CN26</b>	<b>CF TYPEII Connector</b>
<b>Part Number</b>	1653050111
<b>Footprint</b>	COMPACK-60111220
<b>Description</b>	CF Header Typell 50P 90D(M) Standoff 60311220
<b>Pin</b>	<b>Pin Name</b>
1	GND
2	PDD3
3	PDD4
4	PDD5
5	PDD6
6	PDD7
7	PDCS#1
8	GND
9	GND
10	GND
11	GND
12	GND
13	+5 V
14	GND
15	GND

16	GND
17	GND
18	PDA2
19	PDA1
20	PDA0
21	PDD0
22	PDD1
23	PDD2
24	NC
25	GND
26	GND
27	PDD11
28	PDD12
29	PDD13
30	PDD14
31	PDD15
32	PDCS#3
33	GND
34	PDIOR#
35	PDIOW#
36	WE#
37	IRQ
38	+5 V
39	CF_CSEL#
40	GND
41	RESET#
42	PDIORDY
43	PDDREQ
44	PDDACK#
45	DASP#
46	PDIAG#
47	PDD8
48	PDD9
49	PDD10
50	GND

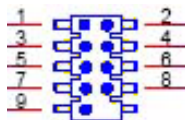
**CN28: USB5/6 Connector**

<b>CN28</b>	<b>USB5/6 Connector</b>
<b>Part Number</b>	1653005260
<b>Footprint</b>	HD_5x2P_79_BOX_N10
<b>Description</b>	PIN HEADER 5x2P 180D(M) 2.0mm SMD IDIOT-PROOF
<b>Pin</b>	<b>Pin Name</b>
1	+5V Dual
2	+5V Dual
3	USB5_P-
4	USB6_P-
5	USB5_P+
6	USB6_P+
7	GND
8	GND
9	GND

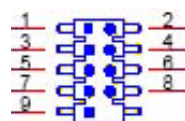
**CN29: USB7/8 Connector**

<b>CN29</b>	<b>USB7/8 Connector</b>
<b>Part Number</b>	1653005260
<b>Footprint</b>	HD_5x2P_79_BOX_N10
<b>Description</b>	PIN HEADER 5x2P 180D(M) 2.0mm SMD IDIOT-PROOF
<b>Pin</b>	<b>Pin Name</b>
1	+5V Dual
2	+5V Dual
3	USB7_P-
4	USB8_P-
5	USB7_P+
6	USB8_P+
7	GND
8	GND
9	GND

### CN30: Mini PCIe Slot

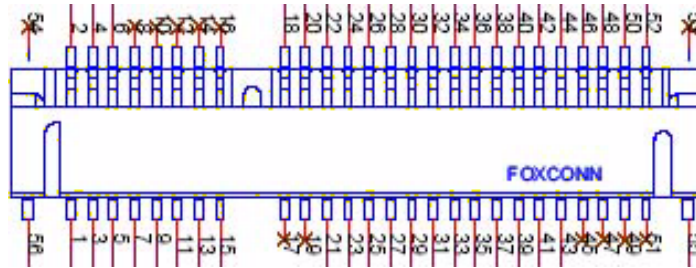

<b>CN30</b>	<b>Mini PCIe Slot</b>
<b>Part Number</b>	1654002538
<b>Footprint</b>	FOX_AS0B226-S68K7F
<b>Description</b>	MINI PCI express 52P 90D SMD H=6.8mm

### CN31: Mini PCIe Lock

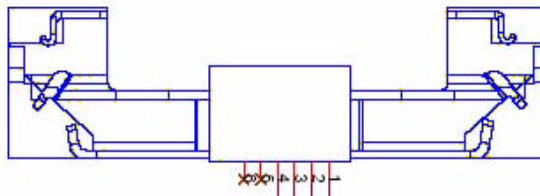

<b>CN31</b>	<b>Mini PCIe Lock</b>
<b>Part Number</b>	1654002539
<b>Footprint</b>	FOX_AS0B226-S68K7F_HOLDER
<b>Description</b>	MINI PCI Express LATCH 52P 90D SMD 6.8mm

### CN32: SATA 1 Connector

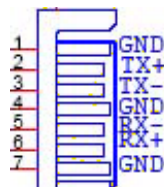

<b>CN32</b>	<b>SATA 1 Connector</b>
<b>Part Number</b>	1654007578
<b>Footprint</b>	SATA_7P_0-1770655-1_D
<b>Description</b>	

Pin	Pin Name
1	GND
2	TX+
3	TX-
4	GND
5	RX-
6	RX+
7	GND

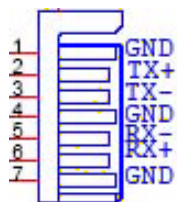

**CN33: SATA 2 Connector**

<b>CN33</b>	<b>SATA 2 Connector</b>
<b>Part Number</b>	1654007578
<b>Footprint</b>	SATA_7P_0-1770655-1_D
<b>Description</b>	
<b>Pin</b>	<b>Pin Name</b>
1	GND
2	TX+
3	TX-
4	GND
5	RX-
6	RX+
7	GND

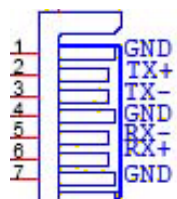
**CN34: SATA 3 Connector**

<b>CN34</b>	<b>SATA 3 Connector</b>
<b>Part Number</b>	1654007578
<b>Footprint</b>	SATA_7P_0-1770655-1_D
<b>Description</b>	
<b>Pin</b>	<b>Pin Name</b>
1	GND
2	TX+
3	TX-
4	GND
5	RX-
6	RX+
7	GND

### CN35: GPIO1 Connector

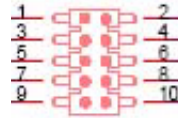

<b>CN35</b>	<b>GPIO1 Connector</b>
<b>Part Number</b>	1653005261
<b>Footprint</b>	HD_5x2P_79_BOX
<b>Description</b>	PIN HEADER SMD 5*2P 180D(M) 2.0mm
<b>Pin</b>	<b>Pin Name</b>
1	+5 V
2	GPIO4
3	GPIO0
4	GPIO5
5	GPIO1
6	GPIO6
7	GPIO2
8	GPIO7
9	GPIO3
10	GND

### CN36: GPIO2 Connector

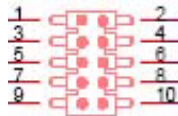

<b>CN36</b>	<b>GPIO2 Connector</b>
<b>Part Number</b>	1653005261
<b>Footprint</b>	HD_5x2P_79_BOX
<b>Description</b>	PIN HEADER SMD 5*2P 180D(M) 2.0mm
<b>Pin</b>	<b>Pin Name</b>
1	+5 V
2	GPIO12
3	GPIO8
4	GPIO13
5	GPIO9
6	GPIO14
7	GPIO10
8	GPIO15
9	GPIO11
10	GND

**CN37: SMBUS Connector**

<b>CN37</b>	<b>SMBUS Connector</b>
<b>Part Number</b>	1655304020
<b>Footprint</b>	WF_4P_79_BOX_R1_D
<b>Description</b>	WAFER BOX 2.0mm 4P 180D(M) W/LOCK A2001WV2-4P
<b>Pin</b>	<b>Pin Name</b>
1	GND
2	SMB_DAT
3	SMB_CLK
4	+5V

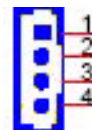
**CN38: I<sup>2</sup>C Connector**

<b>CN38</b>	<b>I<sup>2</sup>C Connector</b>
<b>Part Number</b>	1655304020
<b>Footprint</b>	WF_4P_79_BOX_R1_D
<b>Description</b>	WAFER BOX 2.0mm 4P 180D(M) W/LOCK A2001WV2-4P
<b>Pin</b>	<b>Pin Name</b>
1	GND
2	I <sup>2</sup> C_DAT
3	I <sup>2</sup> C_CLK
4	+5V

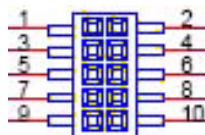
**CN39: COM1 Connector**

<b>CN39</b>	<b>COM1 Connector</b>
<b>Part Number</b>	1653205260
<b>Footprint</b>	HD_5x2P_79_BOX
<b>Description</b>	BOX HEADER SMD 5*2 180D (M) 2.0mm
<b>Pin</b>	<b>Pin Name</b>
1	DCD#
2	DSR#
3	RXD
4	RTS#
5	TXD

6	CTS#
7	DTR#
8	RI#
9	GND
10	GND

**CN40: COM2 Connector**

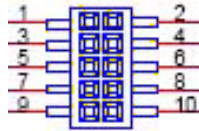

<b>CN40</b>	<b>COM2 Connector</b>
<b>Part Number</b>	1653205260
<b>Footprint</b>	HD_5x2P_79_BOX
<b>Description</b>	BOX HEADER SMD 5*2 180D (M) 2.0mm
<b>Pin</b>	<b>Pin Name</b>
1	DCD#
2	DSR#
3	RXD
4	RTS#
5	TXD
6	CTS#
7	DTR#
8	RI#
9	GND
10	GND

**CN41: COM3 Connector**

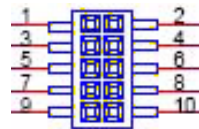

<b>CN41</b>	<b>COM3 Connector</b>
<b>Part Number</b>	1653205260
<b>Footprint</b>	HD_5x2P_79_BOX
<b>Description</b>	BOX HEADER SMD 5*2 180D (M) 2.0mm
<b>Pin</b>	<b>Pin Name</b>
1	DCD#
2	DSR#
3	RXD
4	RTS#
5	TXD
6	CTS#
7	DTR#
8	RI#
9	GND
10	GND

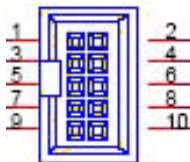
**CN42: COM 4/5 (422 / 485) Connector**

<b>CN42</b>	<b>COM 4/5 (422 / 485) Connector</b>
<b>Part Number</b>	1653205201
<b>Footprint</b>	BH5X2DV-2M
<b>Description</b>	BOX HEADER 5*2P 180D(M) 2.0mm DIP W/O Pb
<b>Pin</b>	<b>Pin Name</b>
1	COM5_TXD (5_422_RXD-)
2	COM4_TXD (4_422_RXD-)
3	COM5_RTS# (5_422_RXD+)
4	COM4_RTS# (4_422_RXD+)
5	COM5_RXD (5_485-422_TXD+)
6	COM4_RXD (4_485-422_TXD+)
7	COM5_CTS# (5_485-422_TXD-)
8	COM4_CTS# (4_485-422_TXD-)
9	GND
10	GND

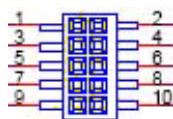
**CN43: COM6 Connector**

<b>CN43</b>	<b>COM6 Connector</b>
<b>Part Number</b>	1653205260
<b>Footprint</b>	HD_5x2P_79_BOX
<b>Description</b>	BOX HEADER SMD 5*2 180D (M) 2.0mm
<b>Pin</b>	<b>Pin Name</b>
1	COM5_DCD#
2	COM5_DSR#
3	COM5_RXD
4	COM5_RTS#
5	COM5_TXD
6	COM5_CTS#
7	COM5_DTR#
8	COM5_RI#
9	GND
10	GND

### CN44: -5V and -12V Connector

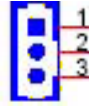

<b>CN44</b>	<b>-V5 and -V12 Connector</b>
<b>Part Number</b>	1655303020
<b>Footprint</b>	WHL3V-2M
<b>Description</b>	WAFER BOX 2.0mm 3P 180D w/LOCK
<b>Pin</b>	<b>Pin Name</b>
1	-5V
2	GND
3	-12V

### CN45: SPI Flash Connector

<b>CN45</b>	<b>SPI Flash Connector</b>
<b>Part Number</b>	1651000682
<b>Footprint</b>	SOCKET_8P_ACA-SPI-004-K01
<b>Description</b>	IC SKT 8P SMD WO/Pb C ACA-SPI-004-K01
<b>Pin</b>	<b>Pin Name</b>
1	SPI_CS#
2	SPI_SO
3	SPI_WP#
4	GND
5	SPI_SI
6	SPI_CLK
7	SPI_HOLD#
8	+3.3V Dual

### CN46: SATA Power Connector

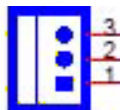

<b>CN46</b>	<b>SATA Power Connector</b>
<b>Part Number</b>	<b>1655002000</b>
<b>Footprint</b>	WHP2V
<b>Description</b>	Wafer P=2.54mm 2P 180D(M) DIP 2542-WS-2
<b>Pin</b>	<b>Pin Name</b>
1	+5V
2	GND

**FAN1: System Fan Connector**

<b>FAN1</b>	<b>System Fan Connector</b>
<b>Part Number</b>	1655003010
<b>Footprint</b>	WHP3VA
<b>Description</b>	Wafer 2.54mm 3P 180D(M) DIP W/LOCK 22-27-2031
<b>Pin</b>	<b>Pin Name</b>
1	GND
2	+12V
3	SPEED

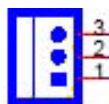
**FAN2: CPU Fan Connector**

<b>FAN2</b>	<b>CPU Fan Connector</b>
<b>Part Number</b>	1655003010
<b>Footprint</b>	WHP3VA
<b>Description</b>	Wafer 2.54mm 3P 180D(M) DIP W/LOCK 22-27-2031
<b>Pin</b>	<b>Pin Name</b>
1	GND
2	+12V
3	SPEED

**PCI1: PCI Slot**

<b>PCI1</b>	<b>PCI Slot</b>
<b>Part Number</b>	1654002099
<b>Footprint</b>	SL-PCI
<b>Description</b>	SLOT 60x2P 180D(F) DIP EH06001-HHW-DF





# Appendix **B**

Optional Extras for  
PCM-9562 A1

The PCM-9562 requires several cables for normal operation. You can make them yourself or purchase an optional cable kit assembly, which includes the following

## B.1 PCM-10586-9562E Cable kit for PCM-9562 A1

**Table B.1: PCM-10586-9562E Cable kit for PCM-9562 A1**

Part No.	Cable Description	q/ty	PCM-9562 Connector	Terminating Connector
1700160160	Audio cable	1	CN4	Cable 16Pin(2.0mm) Audio 16cm
170304015K	AT Power cable	1	CN5	AT Cable 4P x2/4200-H-4P 15cm
1700002142	GbE cable	3	CN10, CN12, CN14	LAN Cable IDC10P 2.0mm/RJ45 15CM
1700260250	LPT port cable	1	CN15	Cable 25cm 25P to 26P ASS'Y LPT Port 2.0mm
1700019109	COM 4/5 cable	1	CN42	A Cable 2*5P-2.0/D-SUB(M) 9P+D-SUB(M) 9P 25cm
1703100260	USB Port cable	4	CN20, CN21, CN28, CN29	Wire 10P 26cm 2.0mm For USB 2 PORT
1703060191	PS2 KB/MS Cable	1	CN25	Cable 6P-2.0mm Housing/ 6P (PS/2)/6P (K/B) 19cm
1700008941	SATA Cable	3	CN32, CN33, CN34	M Cable SATA 7P/SATA 7P 30CM C=R 180/180
1700001296	VGA cable	1	CN8	VGA Cable D-SUB 3*5P(F)/2*8P-2.0 15CM
1700100250	COM1/2/3/6	4	CN39, CN40, CN41,CN43	F Cable IDE#2 10P-2.0/D-SUB 9P(M) 25CM
1703150102	SATA Power Cable	3	None	SATA Power cable L=10cm

**Note!**  The cables PN maybe change because vendor phase out or change cable in the future. So, for detail information please refer to PCM-10586-9562E user note.

# Appendix **C**

Prog. GPIO &  
Watchdog Timer

## C.1 Watchdog Timer

### C.1.1 First Watchdog (SCH3106)

```
    ;The SCH3114/SCH3106 Runtime base I/O address is 800h
    ;Setting WatchDog time value location at offset 66h
    ;If set value "0", it is mean disable WatchDog function.
    Superio_GPIO_Port = 800h
    mov  dx,Superio_GPIO_Port + 66h
    mov  al,00h
    out  dx,al

.model small
    .486p
    .stack 256
    .data
    SCH3114_IO EQU 800h
    .code
    org 100h

.STARTUp
;=====
;47H
;enable WDT function bit [3:2]=11
;=====

    mov  dx,SCH3114_IO + 47h
    mov  al,0ch
    out  dx,al

;=====
;65H
;bit [1:0]=Reserved
;bit [6:2]Reserve=00000
;bit [7] WDT time-out Value Units Select
;Minutes=0 (default) Seconds=1
;=====

    mov  dx,SCH3114_IO + 65h ;
    mov  al,080h
    out  dx,al

;=====
;66H
;WDT timer time-out value
;bit[7:0]=0~255
;=====
```

```

mov dx,SCH3114_IO + 66h
mov al,01h
out dx,al

;=====
;bit[0] status bit R/W
;WD timeout occurred =1
;WD timer counting = 0
;=====

mov dx,SCH3114_IO + 68h
mov al,01h
out dx,al
.exit
END

```

### C.1.2 Second Watchdog (MAX6369)

There are 2 modes for second watchdog timer. One is initial mode and another is programmable mode.

#### 1. Initial mode

When we turn on PCM-9562, second watchdog timer will start to count down 60 sec. If system can't boot normally, second watchdog will send out reset signal to re-start PCM-9562. If PCM-9562 is booted, second watchdog timer will disable initial mode and enter programmable mode.

#### 2. Programmable mode

After PCM-9562 is booted, second watchdog timer enter programmable mode. User can depend on their requirement to trigger second watchdog timer by SUSI API.

ICH8M GPIO Logic Input		MAX6369
GPIO19	GPIO21	Level (Sec)
0	0	10 ms
0	1	Disabled
1	0	1 s
1	1	60 s

\*Detail information; please refer to SUSI API document.

## C.2 GPIO Sample Code

```

;=====
===
NEWIODELAY Macro
out 0ebh,al
ENDM
;=====
=====

```

```

.model small
.486p
.stack 256
.data

;=====
====
;           Data Area
;=====
====
SMBus_Port EQU500h
PCA9554_ID EQU 40h
Input_Reg EQU 00h
Output_Reg EQU 01h
Inversion_Reg EQU 02h
Configure_Reg EQU 03h
;RA02 Advantech_Str db 'Advantech Company Copyright (C) 2005 Design by
Duncan',0Ah,0Dh,'$'
Advantech_Str db 'Advantech Company Copyright (C) 2005 Design by Dun-
can, Modify by Steven',0Ah,0Dh,'$' ;RA02
GX3_Fun_Str db 'Check Philip GPIO function.',0Ah,0Dh,'$'
Note1_Str db 'Test Method: GPIO 0 connect to GPIO 1.',0Ah,0Dh,'$'
Note2_Str db ' GPIO 2 connect to GPIO 3.',0Ah,0Dh,'$'
Note3_Str db ' GPIO 4 connect to GPIO 5.',0Ah,0Dh,'$'
Note4_Str db ' GPIO 6 connect to GPIO 7.',0Ah,0Dh,'$'
Success1_Str db 'First GPIO Chip Test success !! ',0Ah,0Dh,'$'
Success2_Str db 'Second GPIO Chip Test success !! ',0Ah,0Dh,'$'
;RA02 - START
Success_lenght EQU ($ - offset Success1_Str) / 2
db 'Third GPIO Chip Test success !! ',0Ah,0Dh,'$'
db 'Fouth GPIO Chip Test success !! ',0Ah,0Dh,'$'
db 'Fifth GPIO Chip Test success !! ',0Ah,0Dh,'$'
db 'Sixth GPIO Chip Test success !! ',0Ah,0Dh,'$'
db 'Seventh GPIO Chip Test success !! ',0Ah,0Dh,'$'
db 'Eighth GPIO Chip Test success !! ',0Ah,0Dh,'$'
;RA02 - END
Fail_Str db 'First GPIO Chip Test Fail !! ',0Ah,0Dh,'$'
Fail2_Str db 'Second GPIO Chip Test Fail !! ',0Ah,0Dh,'$'
;RA02 - START
Fail_lenght EQU ($ - offset Fail_Str) / 2
db 'Third GPIO Chip Test Fail !! ',0Ah,0Dh,'$'
db 'Fouth GPIO Chip Test Fail !! ',0Ah,0Dh,'$'
db 'Fifth GPIO Chip Test Fail !! ',0Ah,0Dh,'$'
db 'Sixth GPIO Chip Test Fail !! ',0Ah,0Dh,'$'
db 'Seventh GPIO Chip Test Fail !! ',0Ah,0Dh,'$'
db 'Eighth GPIO Chip Test Fail !! ',0Ah,0Dh,'$'

```

```

    Error_Str1      db 'Error !! The system has no GPIO Chip or no support INT15
hook! ',0Ah,0Dh,'$'
;RA02 - END

```

```

=====
=====
;      Main Program Start
;=====
=====

```

```
.code
```

```
    org 100h
```

```
.STARTup
```

```
    ;Clear Screen
```

```
    pusha
```

```
    lea dx, Advantech_Str
```

```
    mov ah,09h
```

```
    int 21h
```

```
    lea dx, GX3_Fun_Str
```

```
    mov ah,09h
```

```
    int 21h
```

```
    lea dx, Note1_Str
```

```
    mov ah,09h
```

```
    int 21h
```

```
    lea dx, Note2_Str
```

```
    mov ah,09h
```

```
    int 21h
```

```
    lea dx, Note3_Str
```

```
    mov ah,09h
```

```
    int 21h
```

```
    lea dx, Note4_Str
```

```
    mov ah,09h
```

```
    int 21h
```

```
;RA02 - START
```

```

=====
=====

```

```

;      Get Number of GPIO group
;      one group mean 8 gpio pins(one GPIO Chip)

```

```
; Input:
```

```
;      ax=5E87h
```

```
;      bh=00h
```

```
; output:
```

```
;      ax=5E78      ;function success, other value means function fail
```

```
;      cl= n group of gpio
```

```

=====
====

;
=====
====

;   Get GPIO Config
; Input:
;   ax=5E87h
;   bh=01h
;   cl= n ; n means which group of GPIO you want to get
; output:
;   ax=5E78      ;function success, other value means function fail
;   bl= the n group of gpio config
;   bit 0 = gpio 0 , 0 => output pin; 1 => input pin
;   bit 1 = gpio 1 , 0 => output pin; 1 => input pin
;   ....
;   bit 7 = gpio 7 , 0 => output pin; 1 => input pin
;
=====
====

;
=====
====

;   Set GPIO Config
; Input:
;   ax=5E87h
;   bh=02h
;   cl= n ; n means which group of GPIO you want to set
;   bl= the n group of gpio config
;   bit 0 = gpio 0 , 0 => output pin; 1 => input pin
;   bit 1 = gpio 1 , 0 => output pin; 1 => input pin
;   ....
;   bit 7 = gpio 7 , 0 => output pin; 1 => input pin
; output:
;   ax=5E78      ;function success, other value means function fail
;
=====
====

;
=====
====

;   Get GPIO status
; Input:
;   ax=5E87h
;   bh=03h
;   cl= n ; n means which group of GPIO you want to get
; output:
;   ax=5E78      ;function success, other value means function fail

```



```

;    bl= the n group of gpio status
;    bit 0 = gpio 0 , 0 => Low; 1 => High
;    bit 1 = gpio 1 , 0 => Low; 1 => High
;    ....
;    bit 7 = gpio 7 , 0 => Low; 1 => High
;=====
=====

;=====
=====
;    Set GPIO status
; Input:
;    ax=5E87h
;    bh=04h
;    cl= n ; n means which group of GPIO you want to set
;    bl= the n group of gpio status
;    bit 0 = gpio 0 , 0 => Low; 1 => High
;    bit 1 = gpio 1 , 0 => Low; 1 => High
;    ....
;    bit 7 = gpio 7 , 0 => Low; 1 => High
; output:
;    ax=5E78      ;function success, other value means function fail
;=====
=====
;RA02 - END
;RA02 - START
    mov  ax,5e87h
    mov  bh,00h
    int  15h
    cmp  ax,5e78h
    je   next_test

    lea  dx, Error_Str1
    mov  ah,09h
    int  21h
    jmp  Finish_Test
next_test:
    xor  ch,ch
    push cx          ;save NO. of GPIO chip
;RA02 - END
;1.Set GPIO 0,2,4,6 as output, GPI 1,3,5,7 as input
;RA02 - START
    mov  ax,5e87h
    mov  bx,02aah
    int  15h
;RA02 - END

```

---

;2. Set GPIO 0,2,4,6 Output Low

;RA02 - START

```
pop    cx          ;restore NO. of GPIO chip
push   cx          ;save NO. of GPIO chip
mov    ax,5e87h
mov    bx,0400h
int    15h
```

;RA02 - END

;3. Check GPI 1,3,5,7 value

;RA02 - START

```
pop    cx          ;restore NO. of GPIO chip
push   cx          ;save NO. of GPIO chip
mov    ax,5e87h
mov    bx,03FFh
int    15h
```

```
pop    cx          ;restore NO. of GPIO chip
push   cx          ;save NO. of GPIO chip
dec    cx
```

```
mov    al,Fail_lenght
mul    cl
lea    dx, Fail_Str
add    dx,ax
cmp    bl,00
jne    test_result
```

;4. Set GPIO 0,2,4,6 Output differential

```
pop    cx          ;restore NO. of GPIO chip
push   cx          ;save NO. of GPIO chip
mov    ax,5e87h
mov    bx,0411h
int    15h
```

;5. Check GPI 1,3,5,7 value

```
pop    cx          ;restore NO. of GPIO chip
push   cx          ;save NO. of GPIO chip
mov    ax,5e87h
mov    bx,03FFh
int    15h
```

```
pop    cx          ;restore NO. of GPIO chip
push   cx          ;save NO. of GPIO chip
dec    cx
```

```

        mov  al,Fail_lenght
        mul  cl
        lea  dx, Fail_Str
        add  dx,ax
        cmp  bl,33h
        jne  test_result

;RA02 - END

;RA02      cmp  al,00h
;RA02      jne  test_fail
           ;4.Set GPIO 1,3,5,7 as output,GPIO 0,2,4,6 as input
;RA02 - START
        pop  cx
        push cx
        mov  ax,5e87h
        mov  bx,0255h
        int  15h
;RA02 - END
           ;4. Set GPIO 1,3,5,7 Output High
;RA02 - START
        pop  cx           ;restore NO. of GPIO chip
        push cx          ;save NO. of GPIO chip
        mov  ax,5e87h
        mov  bx,04ffh
        int  15h
;RA02 - END
           ;6. Check GPIO 0,2,4,6 value
;RA02 - START
        pop  cx           ;restore NO. of GPIO chip
        push cx          ;save NO. of GPIO chip
        mov  ax,5e87h
        mov  bx,0300h
        int  15h

        pop  cx           ;restore NO. of GPIO chip
        push cx          ;save NO. of GPIO chip
        dec  cx

        mov  al,Fail_lenght
        mul  cl
        lea  dx, Fail_Str
        add  dx,ax
        cmp  bl,0ffh

```

---

```
jne test_result
```

```
;4. Set GPIO 1,3,5,7 Output differential
```

```
pop cx ;restore NO. of GPIO chip  
push cx ;save NO. of GPIO chip  
mov ax,5e87h  
mov bx,0422h  
int 15h
```

```
;5. Check GPI 0,2,4,6 value
```

```
pop cx ;restore NO. of GPIO chip  
push cx ;save NO. of GPIO chip  
mov ax,5e87h  
mov bx,03FFh  
int 15h
```

```
pop cx ;restore NO. of GPIO chip  
push cx ;save NO. of GPIO chip  
dec cx
```

```
mov al,Fail_lenght  
mul cl  
lea dx, Fail_Str  
add dx,ax  
cmp bl,33h  
jne test_result
```

```
pop cx ;restore NO. of GPIO chip  
push cx ;save NO. of GPIO chip  
dec cx  
mov al,Success_lenght  
mul cl  
lea dx, Success1_Str  
add dx,ax
```

```
;Do Second PCA9554 test
```

```
;1.Set GPIO 0,2,4,6 as output, GPI 1,3,5,7 as input
```

```
test_result:
```

```
mov ah,09h  
int 21h  
pop cx  
dec cx  
jnz next_test
```

```
Finish_Test:
```

```

        popa
        .exit
;=====
;Input  : CL - register index
;        CH - device ID
;Output : AL - Value read
;=====
Ct_I2CReadByteProcNear

        push cx

        mov dx,SMBus_Port +04h
        inc ch
        mov al,ch          ;ID cmd(read)
        out dx,al
        NEWIODELAY
        NEWIODELAY

        call CT_Chk_SMBus_Ready

        pop ax
        mov dl,03h
        out dx,al          ;Index
        NEWIODELAY
        NEWIODELAY

        mov dl,02h
        mov al,48h
        out dx,al          ;Read data
        NEWIODELAY
        NEWIODELAY

        mov cx, 100h

@@:
        newiodelay
        loop short @B

        call CT_Chk_SMBus_Ready

        mov dl,05
        in al,dx           ;Data0
        NEWIODELAY
        NEWIODELAY

```

```

ret
Ct_I2CReadByteEndp
;=====
;Input : CL - register index
;        CH - device ID
;        AL - Value to write
;Output: none
;=====
Ct_I2CWriteByteProcNear

    push ax
    push cx

    mov dx,SMBus_Port +04h
    mov al,ch           ;ID cmd(Write)
    out dx,al
    call Delay5ms
    call Delay5ms

    call CT_Chk_SMBus_Ready

    pop ax
    mov dl,03h
    out dx,al          ;Index
    call Delay5ms
    call Delay5ms

    pop ax
    mov dl,05
    out dx,al          ;Data0
    call Delay5ms
    call Delay5ms

    mov dl,02h
    mov al,48h
    out dx,al          ;write data
    call Delay5ms
    call Delay5ms

    mov cx, 100h
@@:
    newiodelay
    loop short @B

    call CT_Chk_SMBus_Ready

```

```

        ret
Ct_I2CWriteByteEndp
CT_Chk_SMBus_ReadyProcNear
    mov dx,SMBus_Port + 0;status port
    clc
    mov cx,0800h
Chk_I2C_OK:
    in  al,dx      ;get status
    NEWIODELAY
    out dx,al     ;clear status
    NEWIODELAY

    test al, 02H  ;termination of command ?
    jnz  short Clear_final

    and  al, NOT 40H;mask INUSE bit
    or   al,al    ;status OK ?
    jz   short Clear_final

    test al,04h   ;device error
    jnz  short SMBus_Err

    loop short Chk_I2C_OK
    ;Smbus error due to timeout
SMBus_Err:

    stc
    ret
Clear_final:
    clc
    ret
CT_Chk_SMBus_ReadyEndp

;=====
===
Delay5msprocnear
    push cx
    mov cx, 1000
    @@:
    NEWIODELAY
    loop short @B
    pop cx
    ret

```

---

```
Delay5ms    ENDP
Phoenix_debuger proc near
    pushf
    push cx
    push offset PhdebugRetAddr
    push cs
    push cs
    db 0EAh
    dw 0013h
    dw 0DA00h
```

```
PhdebugRetAddr:
    popf
Phoenix_debuger endp
```

```
;=====
====
;      Program END
;=====
====
```

```
END
```



# Appendix **D**

## System Assignments

## D.1 1st MB memory map

**Table D.1: 1st MB memory map**

Addr. Range (Hex)	Device
E0000h - FFFFFh	System ROM
CC000h - DFFFFh	Available
C0000h - C7FFFh	VGA BIOS
B8000h - BFFFFh	CGA/EGA/VGA text
B0000h - B7FFFh	Reserved for graphic mode usage
A0000h - AFFFFh	EGA/VGA graphics
00000h - 9FFFFh	Base memory

## D.2 DMA channel assignments

**Table D.2: DMA channel assignments**

Channel	Function
0	Available
1	Available
2	Floppy disk (8-bit transfer)
3	Available (parallel port)**
4	Cascade for DMA controller 1
5	Available
6	Available
7	Available

\*\* Parallel port DMA default setting: DMA 3, Parallel port DMA selection: DMA 1 or 3

## D.3 Interrupt assignments

**Table D.3: Interrupt assignments**

Interrupt#	Interrupt source
IRQ0	Timer Clock
IRQ1	Keyboard
IRQ2	Second 8259A
IRQ3	COM3/COM6
IRQ4	COM1/COM2
IRQ5	Reserved
IRQ6	Floppy Disk
IRQ7	LPT1
IRQ8	Real time clock
IRQ9	Redirected IRQ2
IRQ10	COM4
IRQ11	COM5
IRQ12	Reserved
IRQ13	Math Coprocessor
IRQ14	Fixed Disk
IRQ15	Reserved

\* Refer to the table of msd.exe

**Table D.4: System I/O Ports**

<b>Addr. Range (Hex)</b>	<b>Device</b>
00h-1Fh	DMA Controller
20h-21h	Interrupt Controller
40h-48h	Timer/Counter
50h-52h	Timer/Counter
60h	Keyboard controller
64h	Keyboard controller
70h-71h	RTC & CMOS
81h-8Fh	DMA Controller
92h	Reset Generator
A0h-A1h	Interrupt Controller
C0h-DEh	DMA Controller
170h-177h	IDE Controller
1F0h-1F7h	IDE Controller
278h-27Fh	Reserved(Parallel port)
2E0h-2E7h	Serial port 6
2E8h-2EFh	Serial port 4
2F0h-2F7h	Serial port 5
2F8h-2FFh	Serial port 3
378h-37Fh	Parallel printer port
3E8h-3EFh	Serial port 2
3F8h-3FFh	Serial port 1
3BCh-3CEh	Reserved(Parallel port)

**ADVANTECH**

*Enabling an Intelligent Planet*

**[www.advantech.com](http://www.advantech.com)**

Please verify specifications before quoting. This guide is intended for reference purposes only.

All product specifications are subject to change without notice.

No part of this publication may be reproduced in any form or by any means, electronic, photocopying, recording or otherwise, without prior written permission of the publisher.

All brand and product names are trademarks or registered trademarks of their respective companies.

© Advantech Co., Ltd. 2011