

Sensor/Actuator cable - SAC-5P-MINMR/0,6-440/MINFR PWR - 1443860

Please be informed that the data shown in this PDF Document is generated from our Online Catalog. Please find the complete data in the user's documentation. Our General Terms of Use for Downloads are valid (<http://download.phoenixcontact.com>)



Power cable, 5-pos., gray PUR/PVC, 1.5 mm², angled 7/8" 16UNF male plug to angled 7/8" 16UNF female plug, length: 0.6 m

Product Features

- ✓ Easy and safe: 100% electrically tested plug-in components
- ✓ Robust connectors in size 7/8"-16UNF
- ✓ High-performance: connectors and cables with a large conductor cross section for power supply



Key commercial data

Packing unit	1 1
Custom tariff number	85444290
Country of origin	Germany

Technical data

Dimensions

Length of cable	0.6 m
-----------------	-------

Ambient conditions

Ambient temperature (operation)	-40 °C ... 90 °C (Plug / socket)
Degree of protection	IP65
	IP67
	IP68

General

Rated current at 40°C	10 A
Rated voltage	600 V
Number of positions	5
Contact resistance	≤ 5 mΩ
Insulation resistance	≥ 10 MΩ

Sensor/Actuator cable - SAC-5P-MINMR/0,6-440/MINFR PWR - 1443860

Technical data

General

Coding	A - standard
Status display	No
Surge voltage category	II
Pollution degree	3
Structure of individual litz in acc. with VDE 0295 / smallest wire diameter	VDE 0295 class 5
Insertion/withdrawal cycles	100

Material

Inflammability class according to UL 94	HB
Contact material	CuZn
Contact surface material	AU
Contact carrier material	PA 66
Material of grip body	TPU
Material, knurls	Zinc die-cast, nickel-plated

Cable

Cable type	PUR/PVC gray
Cable abbreviation	11Y-JZ
AWG signal line	16
Wire colors	Black 1, black 2, black 3, black 4, green/yellow
Overall twist	5 cores, twisted
External sheath, color	Gray RAL 7001
External cable diameter	9.70 mm
Smallest bending radius, fixed installation	73 mm
Smallest bending radius, movable installation	145.5 mm
Cable weight	140 kg/km
Outer sheath, material	PUR
Conductor material	Bare Cu litz wires
Flame resistance	According to UL VW1
	IEC 60332-1-2
Ambient temperature (operation)	-40 °C ... 90 °C (cable, fixed installation)
	5 °C ... 90 °C (cable, flexible installation)

Classifications

eCl@ss

eCl@ss 4.0	27060306
eCl@ss 4.1	27060306

Sensor/Actuator cable - SAC-5P-MINMR/0,6-440/MINFR PWR - 1443860

Classifications

eCl@ss

eCl@ss 5.0	27061801
eCl@ss 5.1	27061801
eCl@ss 6.0	27279218
eCl@ss 7.0	27279218
eCl@ss 8.0	27279218

ETIM

ETIM 2.0	EC000830
ETIM 3.0	EC001855
ETIM 4.0	EC001855
ETIM 5.0	EC001855

UNSPSC

UNSPSC 6.01	31251501
UNSPSC 7.0901	31251501
UNSPSC 11	31251501
UNSPSC 12.01	31251501
UNSPSC 13.2	31251501

Approvals

Approvals

Approvals

UL Listed / cUL Listed / GOST / cULus Listed

Ex Approvals

Approvals submitted

Approval details

Sensor/Actuator cable - SAC-5P-MINMR/0,6-440/MINFR PWR - 1443860

Approvals

UL Listed	
Nominal current IN	10 A
Nominal voltage UN	600 V

cUL Listed	
Nominal current IN	10 A
Nominal voltage UN	600 V

GOST	
------	--

cULus Listed	
--------------	--

Accessories

Accessories

Conductor marking

Insert label - PABA WH/15 - 1013151



Insert label, Strip, white, Unlabeled, Can be labeled with: Plotter, Mounting type: Thread on, Cable diameter: 0.6-50 mm, Lettering field: 15 x 4 mm

Sensor/Actuator cable - SAC-5P-MINMR/0,6-440/MINFR PWR - 1443860

Accessories

Insert label - PABA YE/15 - 1013698



Insert label, Strip, yellow, Unlabeled, Can be labeled with: Plotter, Mounting type: Thread on, Cable diameter: 0.6-50 mm, Lettering field: 15 x 4 mm

Insert label - PABA RD/15 - 1013944



Insert label, Strip, red, Unlabeled, Can be labeled with: Plotter, Mounting type: Thread on, Cable diameter: 0.6-50 mm, Lettering field: 15 x 4 mm

Marker carrier cable

Conductor marker carrier - PATO 2/15 - 1013122



Conductor marker carrier, transparent, Unlabeled, Mounting type: Clip on, Cable diameter: 2.8-4.4 mm, Lettering field: 4 x 15 mm

Conductor marker carrier - PATO 3/15 - 1013135



Conductor marker carrier, transparent, Unlabeled, Mounting type: Clip on, Cable diameter: 4.4-6.7 mm, Lettering field: 4 x 15 mm

Conductor marker carrier - PATO 4/15 - 1013148



Conductor marker carrier, transparent, Unlabeled, Mounting type: Clip on, Cable diameter: 6.7-10 mm, Lettering field: 4 x 15 mm

Sensor/Actuator cable - SAC-5P-MINMR/0,6-440/MINFR PWR - 1443860

Accessories

Marker pen

Marker pen - B-STIFT - 1051993



Marker pen, for manual labeling of unprinted Zack strips, smear-proof and waterproof, line thickness 0.5 mm

Protective cap

Sealing cap - PROT-MINFS-PA-CHAIN - 1430912

7/8" sealing cap made of plastic with fixing band, for sensor cables, for 7/8" connectors



Screw plug - PROT-MINMS-PA-CHAIN - 1430925

7/8" sealing cap made of plastic with fixing band, for sensor cables, for 7/8" sockets



Screwdriver tools

Adapter insert - TSD-M SAC-BIT ADAPTER - 1212600



Adapter bit for TSD-M...torque tools, E6.3-1/4" drive with 4 mm hexagon to accommodate SAC bits

Sensor/Actuator cable - SAC-5P-MINMR/0,6-440/MINFR PWR - 1443860

Accessories

Adapter - SAC BIT MIN-D25 - 1212512



SAC nut, for assembling 7/8" connectors, with 4 mm hexagonal drive

Torque tool

Torque screwdriver - TSD 08 SAC - 1212597



Torque screw driver with preset torque of 0.8 Nm, with 4 mm hexagon for accommodating SAC bits, two-component handle with non-slip grip

Torque screwdriver - TSD-M 1,2NM - 1212224



Torque screw driver, accuracy as per EN ISO 6789 standard, adjustable from 0.3 - 1.2 Nm

Drawings

Schematic diagram



Pin assignment, plug, 7/8"-16UNF, 5-pos., view of male side

Schematic diagram

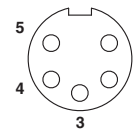

Pin assignment, socket, 7/8"-16UNF, 5-pos., view of female side

Sensor/Actuator cable - SAC-5P-MINMR/0,6-440/MINFR PWR - 1443860

Cable cross section

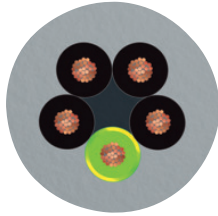

PUR/PVC gray [440]

Dimensioned drawing

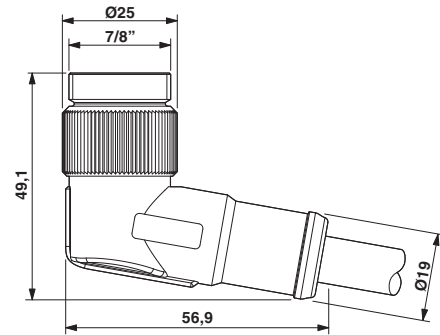

7/8"-16UNF plug, angled

Dimensioned drawing



7/8"-16UNF socket, angled

Circuit diagram



Contact assignment of the 7/8" connector and the 7/8" socket