

# LTM4678EY Dual 25A or Single 50A $\mu$ Module Regulator with Digital Power System Management

## DESCRIPTION

Demonstration circuit 2552A is a dual-output, high efficiency, high density,  $\mu$ Module regulator with 4.5V to 16V input range. Each output can supply 25A maximum load current. The demo board has a [LTM<sup>®</sup>4678](#)  $\mu$ Module regulator, which is a dual 25A or single 50A step-down regulator with digital power system management. Please see LTM4678 data sheet for more detailed information.

DC2552A powers up to default settings and produce power based on configuration resistors without the need for any serial bus communication. This allows easy evaluation of the DC/DC converter. To fully explore the extensive power system management features of the part, download the GUI software LTpowerPlay<sup>®</sup> onto your PC and use Analog Devices' I<sup>2</sup>C/SMBus/PMBus dongle DC1613A

to connect to the board. LTpowerPlay allows the user to reconfigure the part on the fly and store the configuration in EEPROM, view telemetry of voltage, current, temperature and fault status.

### GUI Download

The software can be downloaded from:  
<http://www.analog.com/ltpowerplay>

For more details and instructions of LTpowerPlay, please refer to LTpowerPlay GUI for LTM4678 Quick Start Guide.

**Design files for this circuit board are available at**  
<http://www.analog.com/DC2552A>

All registered trademarks and trademarks are the property of their respective owners.

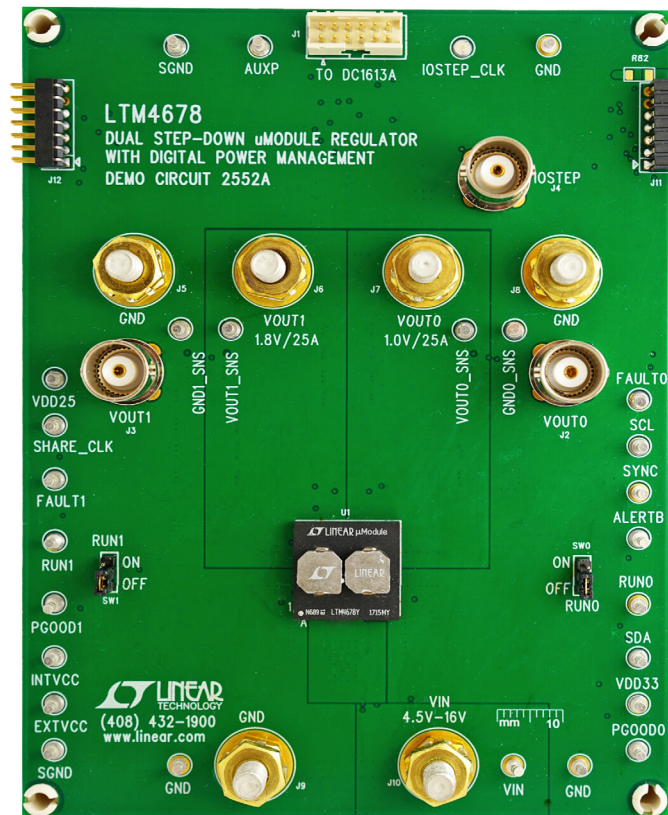

Figure 1. Dual-Output LTM4678/DC2552A Demo Circuit

# DEMO MANUAL DC2552A

## PERFORMANCE SUMMARY Specifications are at $T_A = 25^\circ\text{C}$

PARAMETER	CONDITIONS	MIN	TYP	MAX	UNITS
Input Voltage Range		4.5		16	V
Output Voltage, $V_{OUT0}$	$V_{IN} = 4.5\text{V to }16\text{V}$ , $I_{OUT0} = 0\text{A to }25\text{A}$	0.5	1.0	3.3	V
Maximum Output Current, $I_{OUT0}$	$V_{IN} = 4.5\text{V to }16\text{V}$ , $V_{OUT0} = 0.5\text{V to }3.3\text{V}$		25		A
Output Voltage, $V_{OUT1}$	$V_{IN} = 4.5\text{V to }16\text{V}$ , $I_{OUT1} = 0\text{A to }25\text{A}$	0.5	1.8	3.3	V
Maximum Output Current, $I_{OUT1}$	$V_{IN} = 4.5\text{V to }16\text{V}$ , $V_{OUT1} = 0.5\text{V to }3.3\text{V}$		25		A
Typical Efficiency of CH0	$V_{IN} = 12\text{V}$ , $V_{OUT0} = 1.0\text{V}$ , $I_{OUT0} = 25\text{A}$		85.8 (See Figure 5)		%
Typical Efficiency of CH1	$V_{IN} = 12\text{V}$ , $V_{OUT1} = 1.8\text{V}$ , $I_{OUT1} = 25\text{A}$		90.4 (See Figure 6)		%
Default Switching Frequency			500		kHz

## QUICK START PROCEDURE

Table 1. LTM4678 Demo Boards for up to 250A Point-of-Load Regulation

MAXIMUM OUTPUT CURRENT	NUMBER OF OUTPUTS	NUMBER OF LTM4676 $\mu$ MODULE REGULATORS ON THE BOARD	DEMO BOARD NUMBER
50A	1	1	DC2570A
100A	1	2	DC2638A-A
150A	1	3	DC2638A-B
200A	1	4	DC2638A-C
250A	1	5	DC2638A-D

Demonstration circuit 2552A is easy to set up to evaluate the performance of the LTM4678EY. Refer to Figure 2 for the proper measurement equipment setup and follow the procedure below.

1. With power off, connect the input power supply to  $V_{IN}$  (4.5V to 16V) and GND (input return).
2. Connect the 1.0V output load between  $V_{OUT0}$  and GND (initial load: no load).
3. Connect the 1.8V output load between  $V_{OUT1}$  and GND (initial load: no load).
4. Connect the DVMs to the input and outputs. Set default jumper position: SW1: ON; SW2: ON.
5. Turn on the input power supply and check for the proper output voltages.  $V_{OUT0}$  should be  $1.0\text{V} \pm 1\%$ , and  $V_{OUT1}$  should be  $1.8\text{V} \pm 1\%$ .
6. Once the proper output voltages are established, adjust the loads within the operating range and observe the output voltage regulation, ripple voltage and other parameters.
7. Connect the dongle and control the output voltages from the GUI. See LTpowerPlay GUI for the LTM4678 Quick Start Guide for details.

Note: When measuring the output or input voltage ripple, do not use the long ground lead on the oscilloscope probe. See Figure 3 for the proper scope probe technique. Short, stiff leads need to be soldered to the (+) and (-) terminals of an output capacitor. The probe's ground ring needs to touch the (-) lead and the probe tip needs to touch the (+) lead.

**QUICK START PROCEDURE**

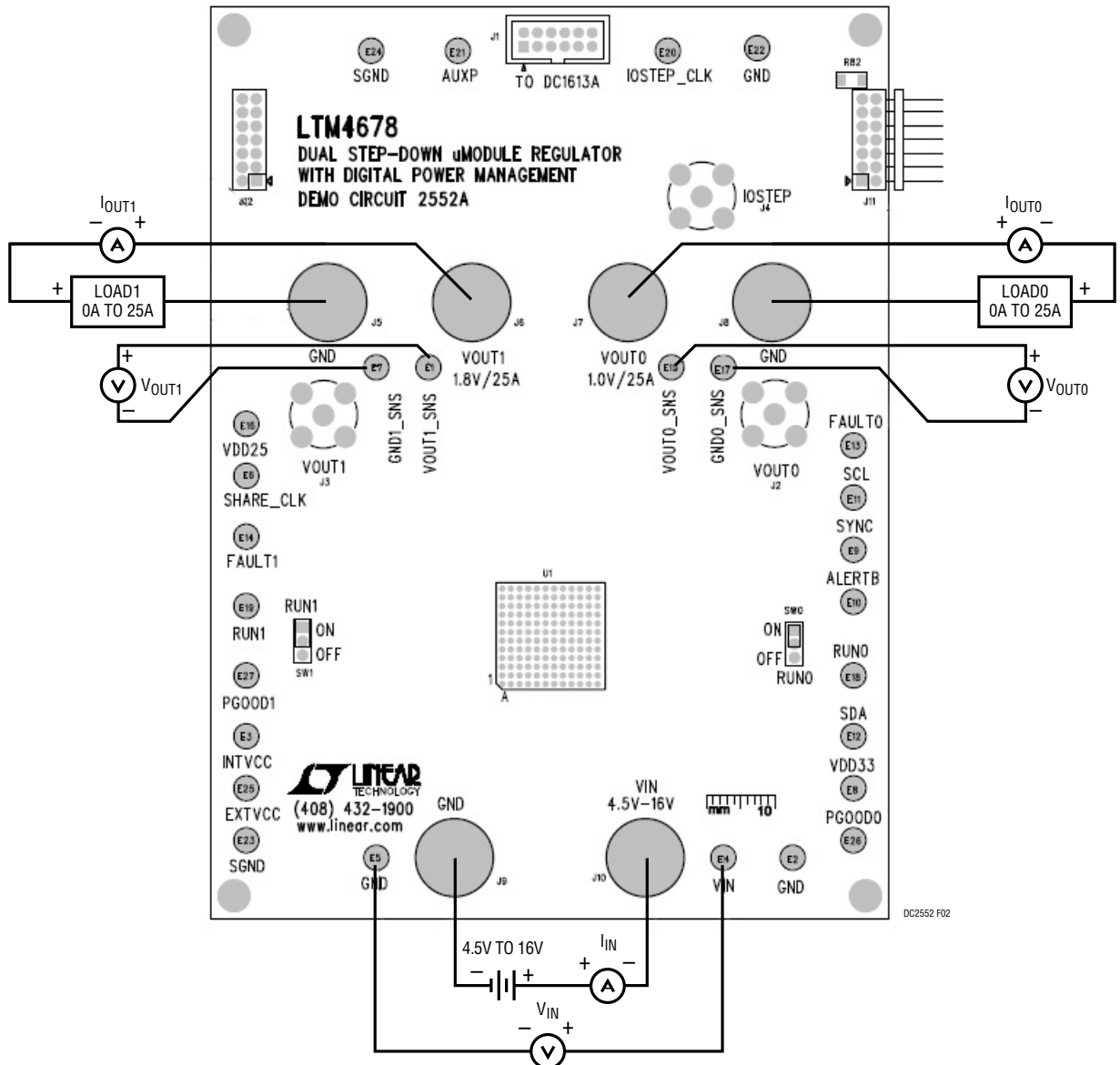

Figure 2. Proper Measurement Equipment Setup

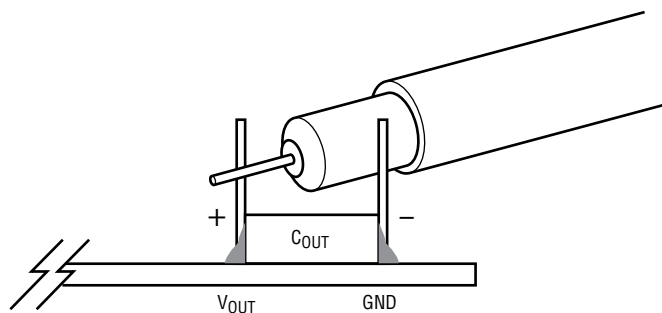

Figure 3. Measuring Output Voltage Ripple

## QUICK START PROCEDURE

### Connecting a PC to DC2552A

You can use a PC to reconfigure the power management features of the LTM4678 such as: nominal  $V_{OUT}$ , margin

set points, OV/UV limits, temperature fault limits, sequencing parameters, the fault log, fault responses, GPIOs and other functionalities. The DC1613A dongle may be plugged when  $V_{IN}$  is present.

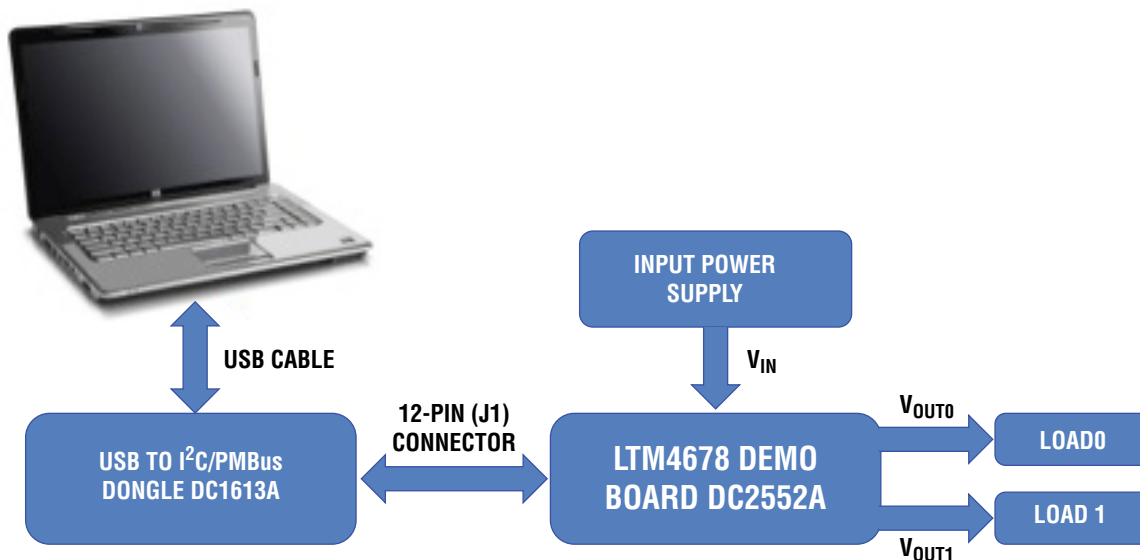

Figure 4. Demo Setup with PC

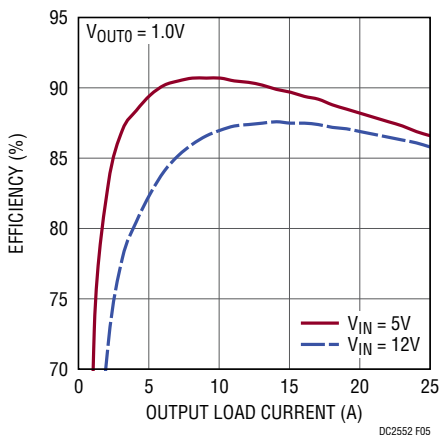

Figure 5. Efficiency vs Load Current on CH0 (CH1 Is Disabled)

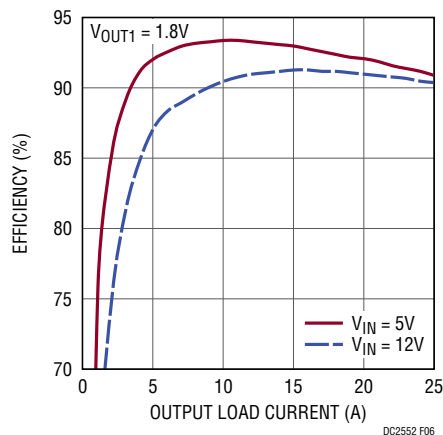

Figure 6. Efficiency vs Load Current on CH1 (CH0 Is Disabled)

## QUICK START PROCEDURE

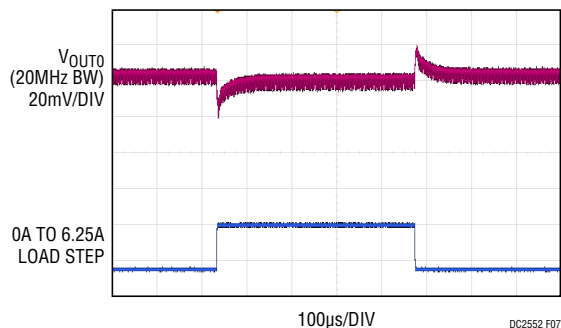

Figure 7. Output Voltage  $V_{OUT0}$  vs Load Current ( $V_{OUT0} = 1.0V$ )

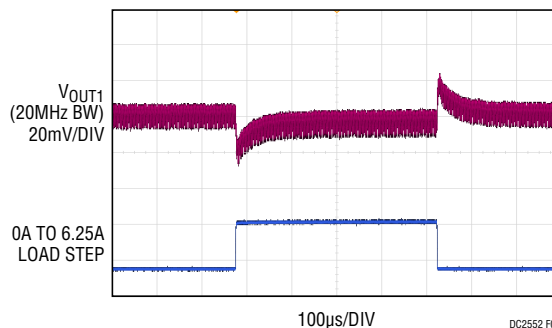

Figure 8. Output Voltage  $V_{OUT1}$  vs Load Current ( $V_{OUT1} = 1.8V$ )

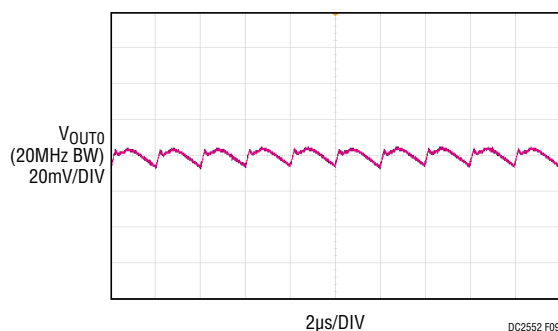

Figure 9. Output Voltage Ripple at  $V_{IN} = 12V$ ,  $V_{OUT0} = 1.0V$ ,  $I_{OUT0} = 25A$

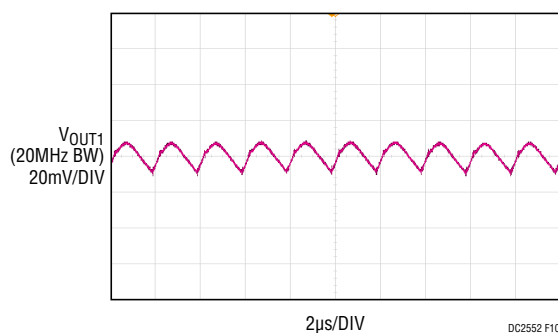

Figure 10. Output Voltage Ripple at  $V_{IN} = 12V$ ,  $V_{OUT1} = 1.8V$ ,  $I_{OUT1} = 25A$

## QUICK START PROCEDURE

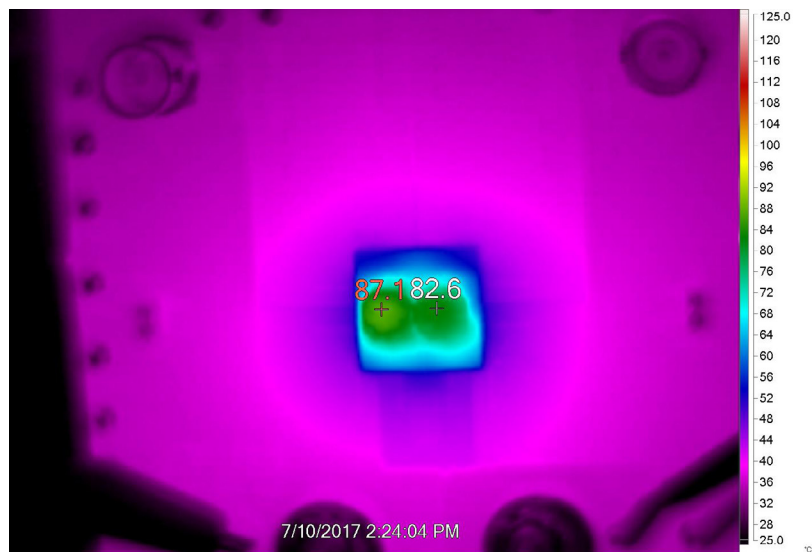

Figure 11. Thermal at  $V_{IN} = 12V$ ,  $V_{OUT0} = 1.0V$ ,  $I_{OUT0} = 25A$ ,  $V_{OUT1} = 1.8V$ ,  $I_{OUT1} = 25A$ ,  $T_A = 25^\circ C$ , 200LFM Airflow

## LTpowerPlay SOFTWARE GUI

LTpowerPlay is a powerful Windows based development environment that supports Analog Devices power system management ICs and  $\mu$ Modules, including the LTM4675, LTM4676, LTM4677, LTM4678, LTC3880, LTC3882 and LTC3883. The software supports a variety of different tasks. You can use LTpowerPlay to evaluate Analog Devices ICs by connecting to a demo board system. LTpowerPlay can also be used in an offline mode (with no hardware present) in order to build a multichip configuration file that can be saved and reloaded at a later time. LTpowerPlay provides unprecedented diagnostic and debug features. It becomes a valuable diagnostic tool during board bring-up to program or tweak the power management scheme in a system, or to diagnose power

issues when bringing up rails. LTpowerPlay utilizes the DC1613A USB-to-SMBus controller to communicate with one of many potential targets, including the LTM4675, LTM4676A, LTM4677, LTM4678, LTC3880, LTC3882, LTC3883's demo system, or a customer board. The software also provides an automatic update feature to keep the software current with the latest set of device drivers and documentation. The LTpowerPlay software can be downloaded from:

<http://www.analog.com/ltpowerplay>

To access technical support documents for LTC Digital Power Products visit the LTpowerPlay Help menu. Online help also available through the LTpowerPlay.

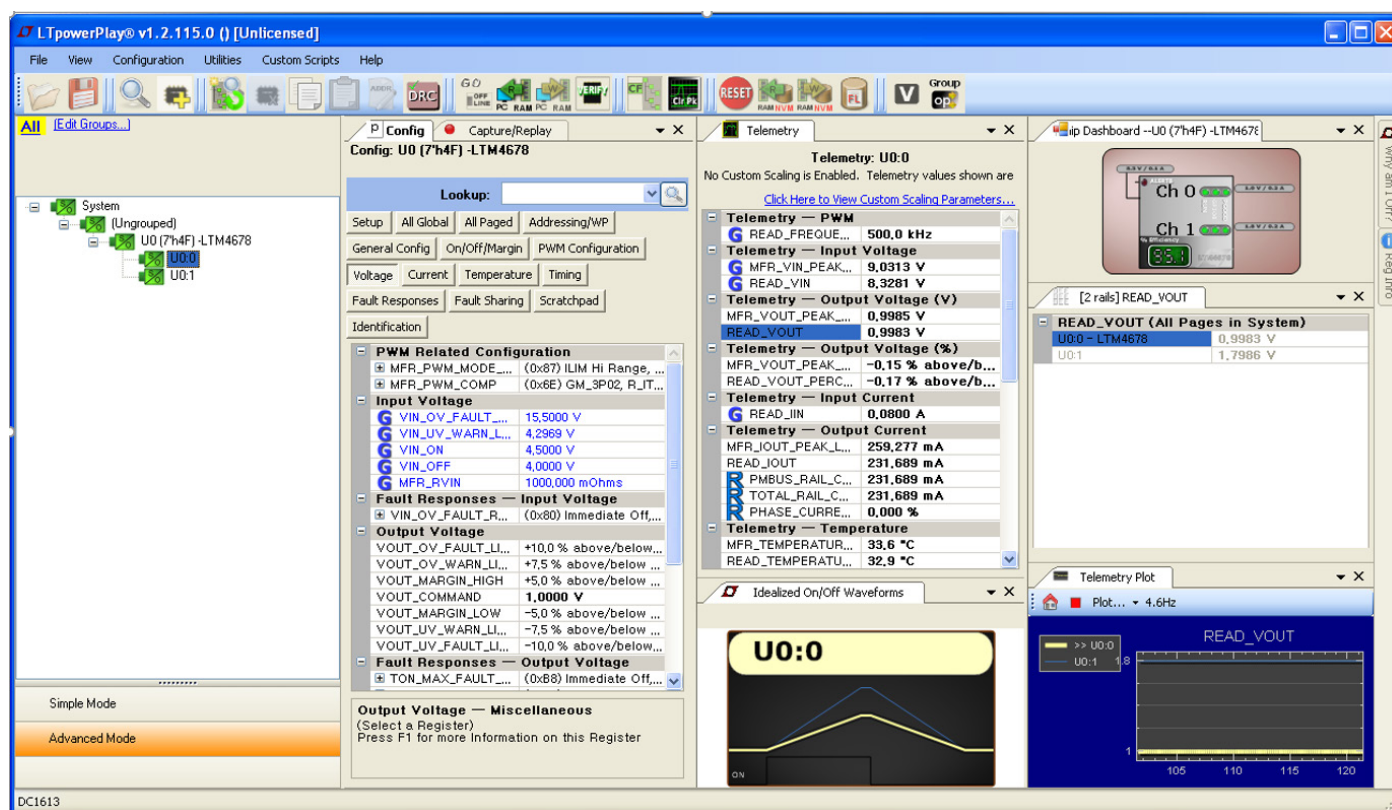
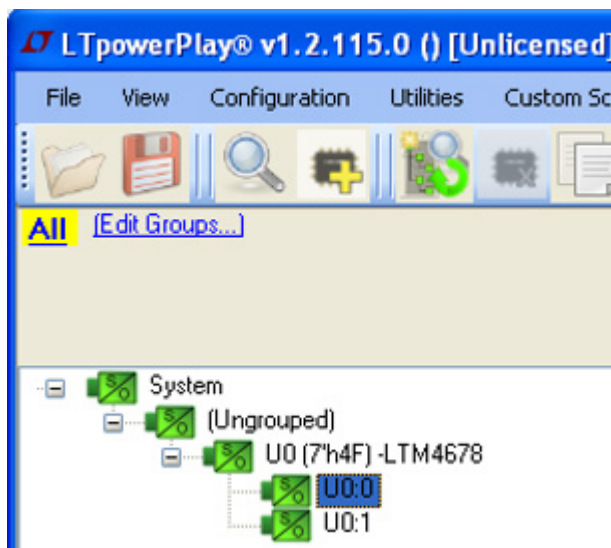

Figure 12. LTpowerPlay Main Interface

## LTpowerPlay QUICK START PROCEDURE

The following procedure describes how to use LTpowerPlay to monitor and change the settings of LTM4678.

1. Download and install the LTpowerPlay GUI: <http://www.analog.com/ltpowerplay>
2. Launch the LTpowerPlay GUI.
  - a. The GUI should automatically identify the DC2552A. The system tree on the left hand side should look like this:



- b. A green message box shows for a few seconds in the lower left hand corner, confirming that LTM4678 is communicating:

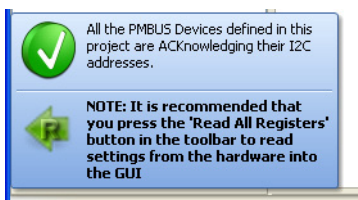

- c. In the Toolbar, click the “R” (RAM to PC) icon to read the RAM from the TM4678. This reads the configuration from the RAM of LTM4678 and loads it into the GUI.



- d. If you want to change the output voltage to a different value, like 1.5V. In the Config tab, type in 1.5 in the VOUT\_COMMAND box, like this:

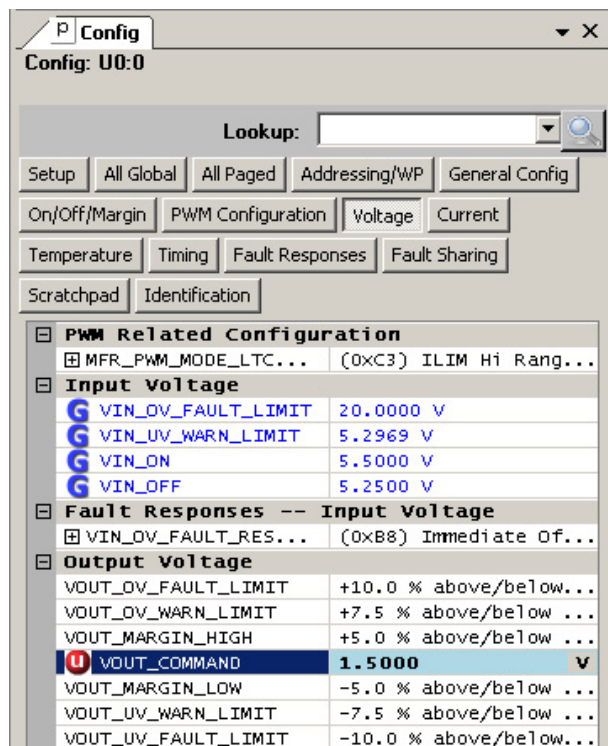

Then, click the “W” (PC to RAM) icon to write these register values to the LTM4678. After finishing this step, you will see the output voltage will change to 1.5V.



If the write is successful, you will see the following message:



- e. You can save the changes into the NVM. In the toolbar, click “RAM to NVM” button, as following



- f. Save the demo board configuration to a (\*.proj) file. Click the Save icon and save the file. Name it whatever you want.



## PARTS LIST

ITEM	QTY	REFERENCE	PART DESCRIPTION	MANUFACTURER/PART NUMBER
<b>Required Circuit Components</b>				
1	1	CIN1	CAP., 150µF, 35V, ALUMINUM ELECTR.,	SUN ELECTRONIC IND, 35CE150AX
2	4	CIN2, CIN3, CIN4, CIN5	CAP., X5R, 10µF, 35V, 10%, 1210	MURATA, GRM32ER6YA106KA12
3	6	COUT1–COUT3, COUT6–COUT8	CAP., X5R, 100µF, 6.3V, 20% 1210	AVX, 12106D107MAT2A
4	4	COUT9–COUT10, COUT11–COUT12	CAP., 470µF, 4V, POSCAP	PANASONIC, 4TPF470ML
5	2	C1, C14	CAP., X7R, 4700pF, 25V, 5%, 0603	AVX, 06033C472JAT2A
6	2	C2, C15	CAP., X7R, 150pF, 25V, 5%, 0603	AVX, 06033C151JAT2A
7	3	C21, C22, C24	CAP., X5R, 1µF, 25V, 10%, 0603	AVX, 06033D105KAT2A
8	1	C23	CAP., X7R, 1µF, 25V, 10%, 0805	AVX, 08053C105KAT2A
9	1	C26	CAP., X5R, 100nF, 16V, 10%, 0603	AVX, 0603YD104KAT
10	2	C27, C28	CAP., X7R, 10nF, 25V, 5%, 0603	AVX, 06033C103JAT
11	1	C30	CAP., X5R, 4.7µF, 6.3V, 10%, 0603	AVX, 06036D475KAT2A
12	1	C33	CAP., X5R, 2.2µF, 6.3V, 10%, 0603	AVX, 06036D225KAT2A
14	1	J1	CONN HEADER 12POS 2MM STR DL PCB	FCI, 98414-G06-12ULF
15	3	J2, J3, J4	CONN, BNC, 5PINS	CONNEX, 112404
16	6	J5, J6, J7, J8, J9, J10	STUD, TEST PIN	PEM, KFH-032-10ET
17	12	J5, J6, J7, J8, J9, J10X2	NUT, BRASS 10-32	ANY, 10-32M/S BR PL
18	6	J5, J6, J7, J8, J9, J10	RING, LUG #10	KEYSTONE, 8205
19	6	J5, J6, J7, J8, J9, J10	WASHER, TIN PLATED BRASS #10	ANY, #10EXT BZ TN
20	1	J11	CONN RECEPT 2MM DUAL R/A 14POS	SULLINS, NPPN072FJFN-RC
21	1	J12	CONN HEADER 14POS 2MM R/A GOLD	MOLEX, 87760-1416
22	1	Q1	MOSFET N-CH 40V 14A TO-252	VISHAY, SUD50N04-8M8P-4GE3
23	1	Q19	MOSFET P-CH 20V 5.9A TO-236	VISHAY, Si2365EDS-T1-GE3
24	6	R3, R25, R32, R69, R70, R93	RES., CHIP, 10Ω, 1%, 0603	VISHAY, CRCW060310R0FKEA
25	9	R7, R9, R33, R63, R65, R66, R91, R92, R106	RES., CHIP, 0Ω 0603	VISHAY, CRCW06030000Z0EA
26	14	R10–R16, R18, R19, R24, R52, R77, R94, R95	RES., CHIP, 10k, 1%, 0603	VISHAY, CRCW060310K0FKEA
27	2	R28, R29	RES, CHIP, 32.4k, 1%, 0603	VISHAY, CRCW060332K4FKEA
28	1	R30	RES, CHIP, 1.65k, 1%, 0603	VISHAY, CRCW06031K65FKEA
29	1	R31	RES, CHIP, 5.23k, 1%, 0603	VISHAY, CRCW06035K23FKEA
30	1	R48	RES., CHIP 0Ω, 0.5W, 2010	VISHAY, CRCW20100000Z0EF
31	1	R53	RES., CHIP, 0.01Ω, 1/2W, 1%, 2010	VISHAY, WSL2010R0100FEA
32	2	R72, R73	RES., CHIP, 4.99k, 1%, 0603	VISHAY, CRCW06034K99FKEA
33	1	R78	RES., CHIP, 15.8k, 1%, 0603	VISHAY, CRCW060315K8FKEA
34	1	R90	RES., CHIP, 0.005Ω, 1/2W, 1%, 2010	VISHAY, WSL20105L000FEA
35	2	SW1, SW0	HEADER, 3 PIN 0.079 SINGLE ROW	SULLINS, NRPN031PAEN-RC
36	1	U1	IC, LTM4678EY#PBF	LINEAR TECH., LTM4678EY#PBF

# DEMO MANUAL DC2552A

## PARTS LIST

ITEM	QTY	REFERENCE	PART DESCRIPTION	MANUFACTURER/PART NUMBER
37	1	U2	I.C., EEPROM SERIAL-I2C, 2K-bit, IC, TSSOP-8	MICROCHIP, 24LC025-I/ST
<b>Additional Demo Board Circuit Components</b>				
1	0	COUT4, COUT5, COUT13-COUT14	RES 0603	OPT
2	0	C16, C17, C29, C31, C32	CAP 0603	OPT
3	0	R8, R26, R27, R35, R38, R41, R49, R61,	RES 0603	OPT
4	0	R50, R51	RES 0603	OPT
5	0	D1, D2	DIODE., SOD323	OPT
6	0	R62, R64, R74, R75, R82, R83, R88, R89,	RES 0603	OPT
<b>Hardware: For Demo Board Only</b>				
13	27	E1-E27	TESTPOINT, TURRET, .062"	MILL-MAX, 2308-2-00-80-00-00-07-0
38	2	XJP1, XJP2	SHUNT	SAMTEC, 2SN-BK-G
39	4	(STAND-OFF)	STAND-OFF, NYLON 0.50" tall	KEYSTONE, 8833(SNAP ON)
40	1		FAB, PRINTED CIRCUIT BOARD	DEMO CIRCUIT 2552A
41	2		STENCIL	STENCIL

## SCHEMATIC DIAGRAM

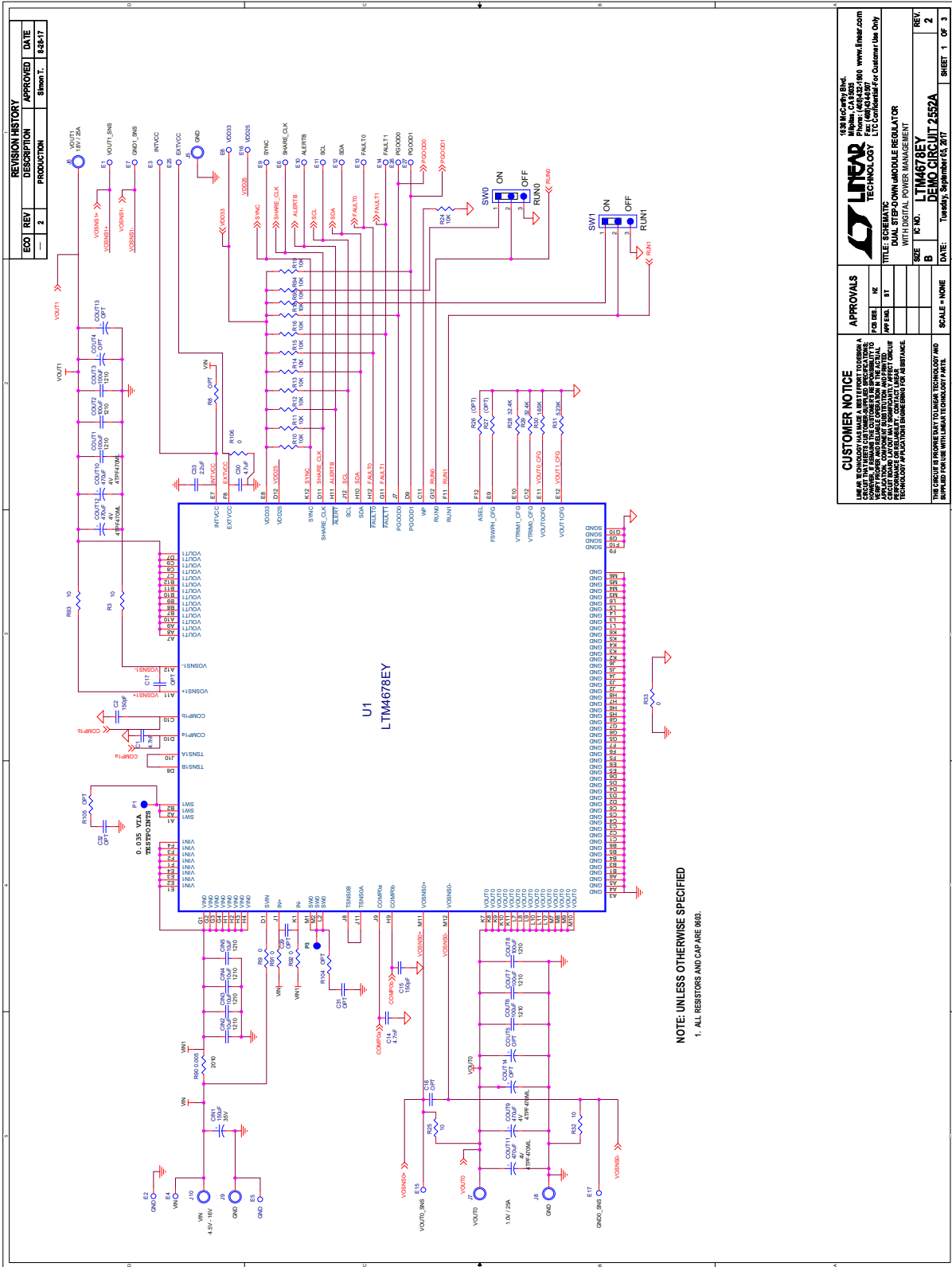

## SCHEMATIC DIAGRAM

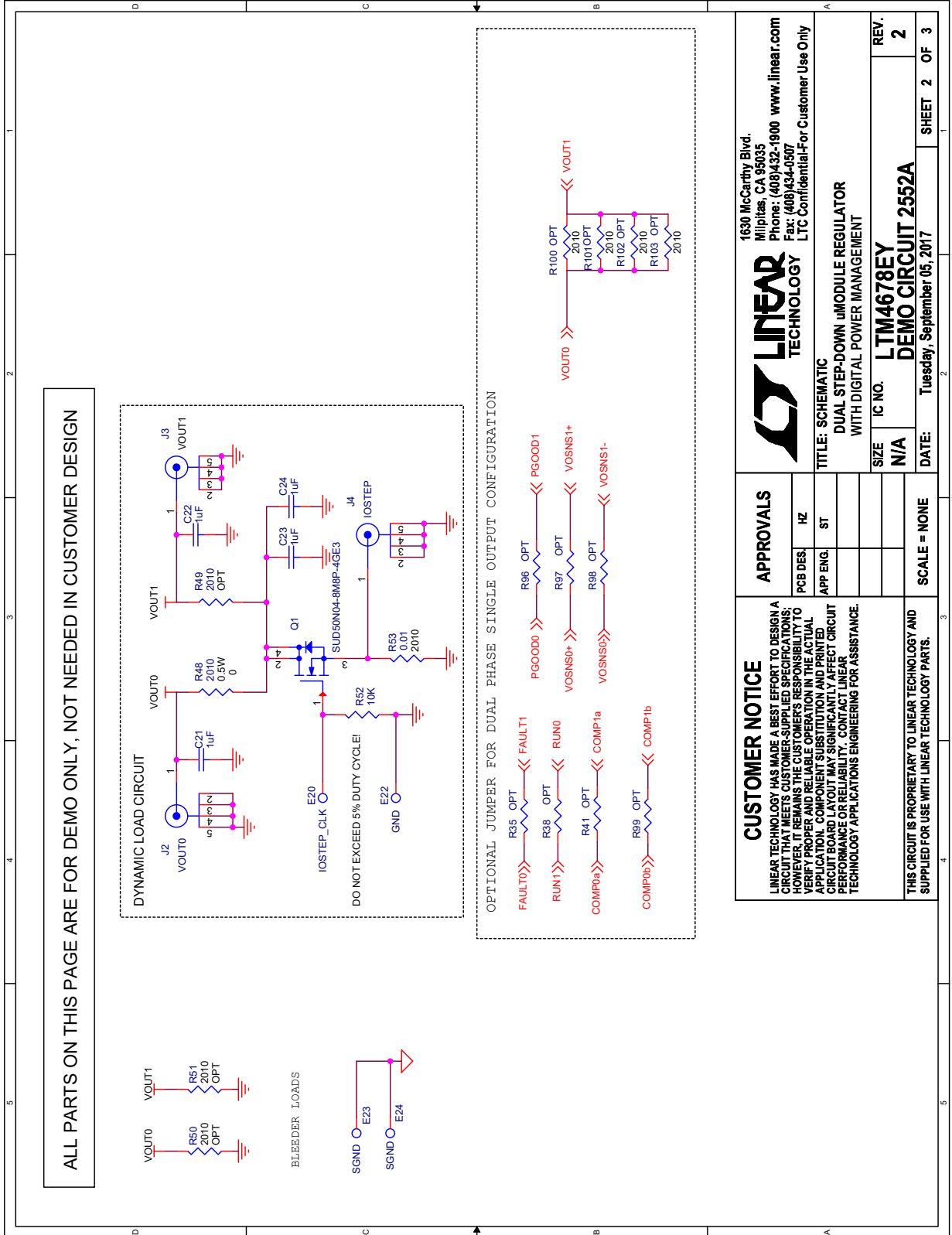

**SCHEMATIC DIAGRAM**

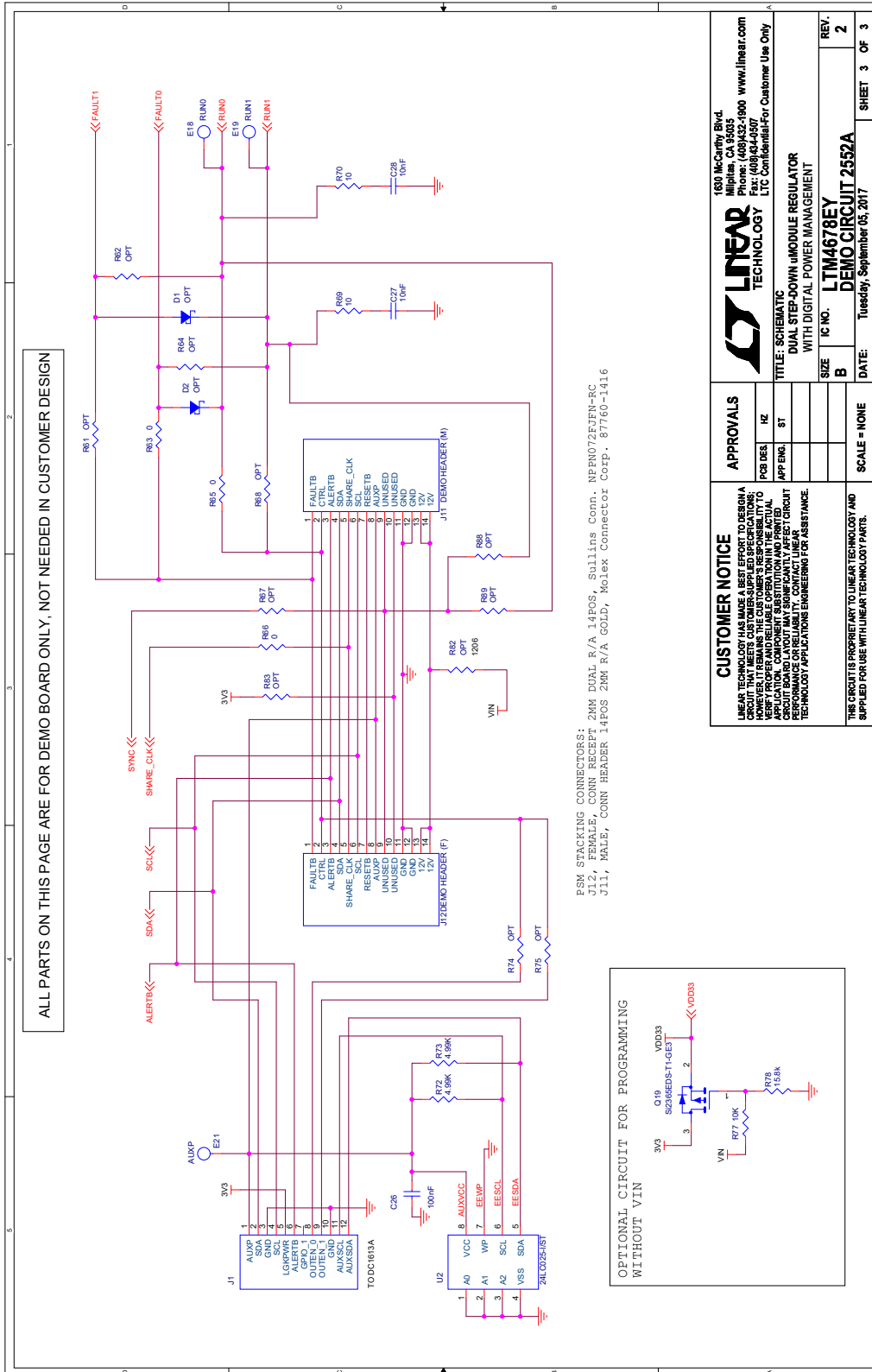



## ESD Caution

**ESD (electrostatic discharge) sensitive device.** Charged devices and circuit boards can discharge without detection. Although this product features patented or proprietary protection circuitry, damage may occur on devices subjected to high energy ESD. Therefore, proper ESD precautions should be taken to avoid performance degradation or loss of functionality.

## Legal Terms and Conditions

By using the evaluation board discussed herein (together with any tools, components documentation or support materials, the "Evaluation Board"), you are agreeing to be bound by the terms and conditions set forth below ("Agreement") unless you have purchased the Evaluation Board, in which case the Analog Devices Standard Terms and Conditions of Sale shall govern. Do not use the Evaluation Board until you have read and agreed to the Agreement. Your use of the Evaluation Board shall signify your acceptance of the Agreement. This Agreement is made by and between you ("Customer") and Analog Devices, Inc. ("ADI"), with its principal place of business at One Technology Way, Norwood, MA 02062, USA. Subject to the terms and conditions of the Agreement, ADI hereby grants to Customer a free, limited, personal, temporary, non-exclusive, non-sublicensable, non-transferable license to use the Evaluation Board FOR EVALUATION PURPOSES ONLY. Customer understands and agrees that the Evaluation Board is provided for the sole and exclusive purpose referenced above, and agrees not to use the Evaluation Board for any other purpose. Furthermore, the license granted is expressly made subject to the following additional limitations: Customer shall not (i) rent, lease, display, sell, transfer, assign, sublicense, or distribute the Evaluation Board; and (ii) permit any Third Party to access the Evaluation Board. As used herein, the term "Third Party" includes any entity other than ADI, Customer, their employees, affiliates and in-house consultants. The Evaluation Board is NOT sold to Customer; all rights not expressly granted herein, including ownership of the Evaluation Board, are reserved by ADI. CONFIDENTIALITY. This Agreement and the Evaluation Board shall all be considered the confidential and proprietary information of ADI. Customer may not disclose or transfer any portion of the Evaluation Board to any other party for any reason. Upon discontinuation of use of the Evaluation Board or termination of this Agreement, Customer agrees to promptly return the Evaluation Board to ADI. ADDITIONAL RESTRICTIONS. Customer may not disassemble, decompile or reverse engineer chips on the Evaluation Board. Customer shall inform ADI of any occurred damages or any modifications or alterations it makes to the Evaluation Board, including but not limited to soldering or any other activity that affects the material content of the Evaluation Board. Modifications to the Evaluation Board must comply with applicable law, including but not limited to the RoHS Directive. TERMINATION. ADI may terminate this Agreement at any time upon giving written notice to Customer. Customer agrees to return to ADI the Evaluation Board at that time. LIMITATION OF LIABILITY. THE EVALUATION BOARD PROVIDED HEREUNDER IS PROVIDED "AS IS" AND ADI MAKES NO WARRANTIES OR REPRESENTATIONS OF ANY KIND WITH RESPECT TO IT. ADI SPECIFICALLY DISCLAIMS ANY REPRESENTATIONS, ENDORSEMENTS, GUARANTEES, OR WARRANTIES, EXPRESS OR IMPLIED, RELATED TO THE EVALUATION BOARD INCLUDING, BUT NOT LIMITED TO, THE IMPLIED WARRANTY OF MERCHANTABILITY, TITLE, FITNESS FOR A PARTICULAR PURPOSE OR NON-INFRINGEMENT OF INTELLECTUAL PROPERTY RIGHTS. IN NO EVENT WILL ADI AND ITS LICENSORS BE LIABLE FOR ANY INCIDENTAL, SPECIAL, INDIRECT, OR CONSEQUENTIAL DAMAGES RESULTING FROM CUSTOMER'S POSSESSION OR USE OF THE EVALUATION BOARD, INCLUDING BUT NOT LIMITED TO LOST PROFITS, DELAY COSTS, LABOR COSTS OR LOSS OF GOODWILL. ADI'S TOTAL LIABILITY FROM ANY AND ALL CAUSES SHALL BE LIMITED TO THE AMOUNT OF ONE HUNDRED US DOLLARS (\$100.00). EXPORT. Customer agrees that it will not directly or indirectly export the Evaluation Board to another country, and that it will comply with all applicable United States federal laws and regulations relating to exports. GOVERNING LAW. This Agreement shall be governed by and construed in accordance with the substantive laws of the Commonwealth of Massachusetts (excluding conflict of law rules). Any legal action regarding this Agreement will be heard in the state or federal courts having jurisdiction in Suffolk County, Massachusetts, and Customer hereby submits to the personal jurisdiction and venue of such courts. The United Nations Convention on Contracts for the International Sale of Goods shall not apply to this Agreement and is expressly disclaimed.