

**PICkit™ 1 Flash
Starter Kit
User's Guide**

Note the following details of the code protection feature on Microchip devices:

- Microchip products meet the specification contained in their particular Microchip Data Sheet.
- Microchip believes that its family of products is one of the most secure families of its kind on the market today, when used in the intended manner and under normal conditions.
- There are dishonest and possibly illegal methods used to breach the code protection feature. All of these methods, to our knowledge, require using the Microchip products in a manner outside the operating specifications contained in Microchip's Data Sheets. Most likely, the person doing so is engaged in theft of intellectual property.
- Microchip is willing to work with the customer who is concerned about the integrity of their code.
- Neither Microchip nor any other semiconductor manufacturer can guarantee the security of their code. Code protection does not mean that we are guaranteeing the product as "unbreakable."

Code protection is constantly evolving. We at Microchip are committed to continuously improving the code protection features of our products. Attempts to break Microchip's code protection feature may be a violation of the Digital Millennium Copyright Act. If such acts allow unauthorized access to your software or other copyrighted work, you may have a right to sue for relief under that Act.

Information contained in this publication regarding device applications and the like is intended through suggestion only and may be superseded by updates. It is your responsibility to ensure that your application meets with your specifications. No representation or warranty is given and no liability is assumed by Microchip Technology Incorporated with respect to the accuracy or use of such information, or infringement of patents or other intellectual property rights arising from such use or otherwise. Use of Microchip's products as critical components in life support systems is not authorized except with express written approval by Microchip. No licenses are conveyed, implicitly or otherwise, under any intellectual property rights.

Trademarks

The Microchip name and logo, the Microchip logo, Accuron, dsPIC, KEELOQ, microID, MPLAB, PIC, PICmicro, PICSTART, PRO MATE, PowerSmart, rfPIC, and SmartShunt are registered trademarks of Microchip Technology Incorporated in the U.S.A. and other countries.

AmpLab, FilterLab, MXDEV, MXLAB, PICMASTER, SEEVAL, SmartSensor and The Embedded Control Solutions Company are registered trademarks of Microchip Technology Incorporated in the U.S.A.

Analog-for-the-Digital Age, Application Maestro, dsPICDEM, dsPICDEM.net, dsPICworks, ECAN, ECONOMONITOR, FanSense, FlexROM, fuzzyLAB, In-Circuit Serial Programming, ICSP, ICEPIC, Migratable Memory, MPASM, MPLIB, MPLINK, MPSIM, PICKit, PICDEM, PICDEM.net, PICLAB, PICtail, PowerCal, PowerInfo, PowerMate, PowerTool, rLAB, rfPICDEM, Select Mode, Smart Serial, SmartTel and Total Endurance are trademarks of Microchip Technology Incorporated in the U.S.A. and other countries.

SQTP is a service mark of Microchip Technology Incorporated in the U.S.A.

All other trademarks mentioned herein are property of their respective companies.

© 2004, Microchip Technology Incorporated, Printed in the U.S.A., All Rights Reserved.

 Printed on recycled paper.

QUALITY MANAGEMENT SYSTEM
CERTIFIED BY DNV
== ISO/TS 16949:2002 ==

Microchip received ISO/TS-16949:2002 quality system certification for its worldwide headquarters, design and wafer fabrication facilities in Chandler and Tempe, Arizona and Mountain View, California in October 2003. The Company's quality system processes and procedures are for its PICmicro® 8-bit MCUs, KEELOQ® code hopping devices, Serial EEPROMs, microperipherals, nonvolatile memory and analog products. In addition, Microchip's quality system for the design and manufacture of development systems is ISO 9001:2000 certified.



PICKIT™ 1 FLASH STARTER KIT USER'S GUIDE

Table of Contents

Preface	1
Introduction.....	1
Highlights.....	1
About This Guide.....	1
Warranty Registration.....	3
Recommended Reading.....	3
Troubleshooting.....	3
Microchip On-Line Support.....	3
Customer Change Notification Service	4
Customer Support	4
Chapter 1. PICKit™ 1 Flash Starter Kit	
1.1 Introduction	5
1.2 Highlights	5
1.3 Running the PICKit 1 Flash Starter Kit Default Demonstration	5
1.4 PICKit 1 Classic and Baseline Flash Programming Software	6
1.5 New To Programming PICmicro® MCUs	6
Chapter 2. PICKit™ 1 Classic Software	
2.1 Introduction	7
2.2 Using PICKit 1 Classic Programming Software	7
Chapter 3. PICKit™ 1 Baseline Flash Software	
3.1 Introduction	13
3.2 Using PICKit 1 Baseline Flash Programming Software	13
Chapter 4. PICKit™ 1 and MPLAB® IDE	
4.1 Introduction	19
4.2 Highlights	19
4.3 Using the PIC12F675 Programming Project Source Code	19
4.4 Project Management in MPLAB IDE	20
Chapter 5. Troubleshooting	
5.1 Introduction	23
5.2 FAQs	23
Appendix A. Hardware Description	
A.1 Introduction	27
A.2 Highlights	27
A.3 In-Circuit Serial Programming™ (ICSP™)	27
A.4 Programming Hardware	27
A.5 USB Communications Protocol	29
A.6 Schematic Diagrams	31

PICkit™ 1 Flash Starter Kit User's Guide

Appendix B. Baseline Flash Microcontroller Programming Schematic Diagram

B.1 Schematic Diagram	37
-----------------------------	----

Appendix C. PIC12F675 Programming Projects

C.1 Introduction	39
C.2 Highlights	39
C.3 Lesson 1 – Switch Debouncing	39
C.4 Lesson 2 – Introduction to State Machines	46
C.5 Lesson 3 – Interrupts	53
C.6 Lesson 4 – Analog-to-Digital Converters and Comparators	57
C.7 Lesson 5 – Program Memory Look-up Routines	60
C.8 Lesson 6 – Data EE Look-up Routines	63
C.9 Lesson 7 – Frequency Counting with Timer1 Gate	66

Worldwide Sales and Service	72
--	-----------



PICKIT™ 1 FLASH STARTER KIT USER'S GUIDE

Preface

INTRODUCTION

This chapter contains general information about this user's guide and customer support that will be useful prior to using the PICKit™ 1 Flash Starter Kit.

HIGHLIGHTS

Items discussed in this chapter are:

- About this Guide
- Warranty Registration
- Recommended Reading
- Troubleshooting
- Microchip On-Line Support
- Customer Change Notification Service
- Customer Support

ABOUT THIS GUIDE

This document describes how to use the PICKit™ 1 Flash Starter Kit. The manual layout is as follows:

- **Chapter 1: PICKit™ 1 Flash Starter Kit** – An overview of the PICKit™ 1 Flash Starter Kit and instructions on how to use it.
- **Chapter 2: PICKit™ 1 Classic Software** – This chapter provides instructions on how to use the PICKit 1 Classic programming software to program 8 and 14-pin Mid-range Flash Microcontroller (MCU) Family devices.
- **Chapter 3: PICKit™ 1 Baseline Flash Software** – This chapter provides instructions on how to use the PICKit 1 Baseline Flash programming software to program 8 and 14-pin Baseline (12-bit Core) Flash Microcontroller (MCU) Family devices.
- **Chapter 4: PICKit™ 1 and MPLAB® IDE** – A quick overview on how to load a project in MPLAB IDE and program a device with MPLAB IDE.
- **Chapter 5: Troubleshooting** – This chapter describes common problems and possible solutions for solving problems with the PICKit™ 1 Flash Starter Kit.
- **Appendix A: PICKit™ 1 Hardware Description** – This appendix contains the PICKit 1 hardware description and schematic diagrams.
- **Appendix B: Baseline Flash Microcontroller Programmer Hardware Description** – This appendix contains the Baseline Flash Microcontroller Programmer hardware description and schematic diagram.
- **Appendix C: PIC12F675 Programming Projects** – This appendix contains introductory lessons for persons new to PICmicro® microcontroller units (MCU).
- **Worldwide Sales and Service** – A listing of Microchip sales and service locations and telephone numbers worldwide.

PICkit™ 1 Flash Starter Kit User's Guide

Conventions Used in This Guide

This manual uses the following documentation conventions:

TABLE 1-1: DOCUMENTATION CONVENTIONS

Description	Represents	Examples
Code (Courier font):		
Plain characters	Sample code Filenames and paths	#define START c:\autoexec.bat
Angle brackets: < >	Variables	<label>, <exp>
Square brackets []	Optional arguments	MPASMWIN [main.asm]
Curly brackets and pipe character: { }	Choice of mutually exclusive arguments; An OR selection	errorlevel {0 1}
Lower case characters in quotes	Type of data	"filename"
Ellipses...	Used to imply (but not show) additional text that is not relevant to the example	list ["list_option...", "list_option"]
0xnnn	A hexadecimal number where n is a hexadecimal digit	0xFFFF, 0x007A
Italic characters	A variable argument; it can be either a type of data (in lower case characters) or a specific example (in upper case characters).	char isascii (char, ch);
Interface (Arial font):		
Underlined, italic text with right arrow	A menu selection from the menu bar	<u>File > Save</u>
Bold characters	A window or dialog button to click	OK, Cancel
Characters in angle brackets < >	A key on the keyboard	<Tab>, <Ctrl-C>
Documents (Arial font):		
Italic characters	Referenced books	<i>MPLAB IDE User's Guide</i>

Documentation Updates

All documentation becomes dated, and this user's guide is no exception. Since the PICkit™ 1 Flash Starter Kit *User's Guide* and other Microchip tools are constantly evolving to meet customer needs, some PICkit™ 1 Flash Starter Kit actual dialogs and/or tool descriptions may differ from those in this document. Please refer to our web site to obtain the latest documentation available.

Documentation Numbering Conventions

Documents are numbered with a "DS" number. The number is located on the bottom of each page, in front of the page number. The numbering convention for the DS Number is: DSXXXXXA,

where:

- XXXXX = The document number.
- A = The revision level of the document.

WARRANTY REGISTRATION

Please complete the enclosed Warranty Registration Card and mail it promptly. Sending in your Warranty Registration Card entitles you to receive new product updates. Interim software releases are available at the Microchip web site.

RECOMMENDED READING

This user's guide describes how to use the PICkit™ 1 Flash Starter Kit. Other useful documents are listed below:

PIC12F629/675 Data Sheet (DS41190)

Consult this document for information regarding the PIC12F629/675 8-pin Flash-based 8-bit CMOS microcontroller device specifications.

PIC16F630/676 Data Sheet (DS40039)

Consult this document for information regarding the PIC16F630/676 14-pin Flash-based 8-bit CMOS microcontroller device specifications.

MPLAB® IDE, Simulator, Editor User's Guide (DS51025)

Consult this document for more information pertaining to the installation and features of the MPLAB Integrated Development Environment (IDE) Software.

To obtain these documents, contact the nearest Microchip sales location (see back page). These documents are also available on the Microchip web site at: www.microchip.com.

Microsoft® Windows® Manuals

This manual assumes that users are familiar with the Microsoft Windows operating system. Many excellent references exist for this software program, and should be consulted for general operation of Windows.

TROUBLESHOOTING

See the Troubleshooting section for information on common problems.

MICROCHIP ON-LINE SUPPORT

Microchip provides on-line support on the Microchip web site at:

<http://www.microchip.com>

A file transfer site is also available by using an FTP service connecting to:

<ftp://ftp.microchip.com>

The web site and file transfer site provide a variety of services. Users may download files for the latest development tools, data sheets, application notes, user guides, articles and sample programs. A variety of Microchip specific business information is also available, including listings of Microchip sales offices and distributors. Other information available on the web site includes:

- Latest Microchip press releases
- Technical support section with FAQs
- Design tips
- Device errata
- Job postings
- Microchip consultant program member listing
- Links to other useful web sites related to Microchip products
- Conferences for products, development systems, technical information and more
- Listing of seminars and events

PICkit™ 1 Flash Starter Kit User's Guide

CUSTOMER CHANGE NOTIFICATION SERVICE

Microchip started the customer notification service to help customers stay current on Microchip products with the least amount of effort. Once you subscribe, you will receive email notifications whenever we change, update, revise or have errata related to your specified product family or development tool.

Go to the Microchip web site (www.microchip.com) and click on Customer Change Notification. Follow the instructions to register.

The Development Systems product group categories are:

- Compilers
- Emulators
- In-Circuit Debuggers
- MPLAB IDE
- Programmers

Here is a description of these categories:

Compilers – The latest information on Microchip C compilers and other language tools. These include the MPLAB C17, MPLAB C18 and MPLAB C30 C Compilers; MPASM™ and MPLAB ASM30 assemblers; MPLINK™ and MPLAB LINK30 linkers; and MPLIB™ and MPLAB LIB30 librarians.

Emulators – The latest information on Microchip in-circuit emulators. This includes the MPLAB ICE 2000 and MPLAB ICE 4000.

In-Circuit Debuggers – The latest information on Microchip in-circuit debuggers. These include the MPLAB ICD and MPLAB ICD 2.

MPLAB – The latest information on Microchip MPLAB IDE, the Windows Integrated Development Environment for development systems tools. This list is focused on the MPLAB IDE, MPLAB SIM simulator, MPLAB IDE Project Manager and general editing and debugging features.

Programmers – The latest information on Microchip device programmers. These include the PRO MATE® II device programmer and PICSTART® Plus development programmer.

CUSTOMER SUPPORT

Users of Microchip products can receive assistance through several channels:

- Distributors
- Local Sales Office
- Field Application Engineers (FAEs)
- Corporate Applications Engineers (CAEs)
- Systems Information and Upgrade Hot Line

Customers should call their distributor or field application engineer (FAE) for support. Local sales offices are also available to help customers. See the last page of this document for a listing of sales offices and locations.

Corporate applications engineers (CAEs) may be contacted at (480) 792-7627.

Systems Information and Upgrade Line

The Systems Information and Upgrade Information Line provides system users with a listing of the latest versions of all of Microchip's development systems software products. Plus, this line provides information on how customers can receive the most current upgrade kits. The Information Line Numbers are:

1-800-755-2345 for U.S. and most of Canada.
1-480-792-7302 for the rest of the world.

Chapter 1. PICkit™ 1 Flash Starter Kit

1.1 INTRODUCTION

The PICkit 1 Flash Starter Kit is a low-cost introductory programmer and starter kit with an easy to use PC host program user interface for programming Microchip's 8/14-pin Flash family of microcontrollers. The starter kit is designed to help the user get up to speed quickly using PIC® microcontrollers.

Starting with Version 2 PC software and PIC16C745 firmware, new Baseline (12-bit Core) Flash PICmicros® can be programmed by the PICkit 1 Flash Starter Kit.

1.2 HIGHLIGHTS

This chapter discusses:

- Running the PICkit 1 Flash Starter Kit Default Demonstration
- PICkit 1 Classic and Baseline Flash Programming Software
- New to Programming PICmicro MCUs

1.3 RUNNING THE PICkit 1 FLASH STARTER KIT DEFAULT DEMONSTRATION

The PICkit 1 Flash Starter Kit comes preprogrammed with a demonstration program. Connect the PICkit 1 Flash Starter Kit to the PC's USB port using the USB cable as shown in Figure 1-1. The demo program will blink the eight red lights in succession. Press the **Push Button Switch**, labeled **SW1**, on the board and the sequence of the lights will change. Rotate the **Variable Resistor**, labeled **RP1**, and the light sequence will blink at a different rate.

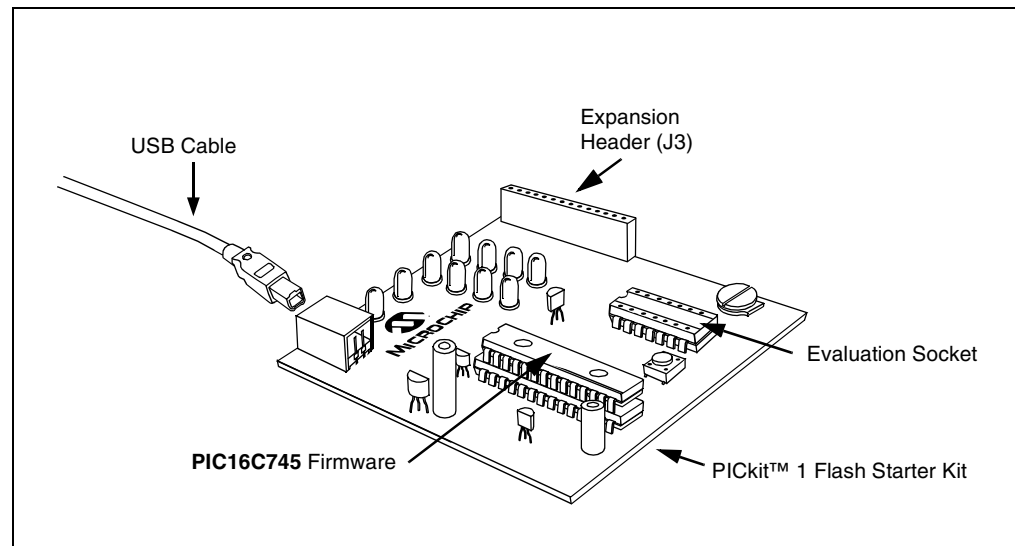
FIGURE 1-1: PICkit 1 FLASH STARTER KIT

PICKit™ 1 Flash Starter Kit User's Guide

1.4 PICKit 1 CLASSIC AND BASELINE FLASH PROGRAMMING SOFTWARE

There are two PC host programs for the PICKit 1 Flash Starter Kit:

1.4.1 PICKit 1 Classic

The PICKit 1 Classic programming software programs 8 and 14-pin Mid-range (14-bit Core) Flash Microcontroller (MCU) Family devices. Instructions on how to use the PICKit 1 Classic program is given in Chapter 2.

1.4.2 PICKit 1 Baseline Flash

The PICKit 1 Baseline Flash programming software programs 6, 8 and 14-pin Baseline (12-bit Core) Flash Microcontroller (MCU) Family devices. Instructions on how to use the PICKit 1 Baseline Flash program is given in Chapter 3.

1.5 NEW TO PROGRAMMING PICmicro® MCUs

Appendix C. "PIC12F675 Programming Projects" contains introductory lessons for persons new to PICmicro® microcontroller units (MCU). The programming projects in the appendix describe different concepts in controlling the PIC12F675 PICmicro® microcontroller unit (MCU). Each lesson includes instructions for running a program demo that illustrates basic concepts. It is best to follow the lessons in sequential order, for each lesson builds upon the previous one. (The hex files and source code for the lessons can be found on the PICKit 1 Flash Starter Kit CDROM.)

Chapter 2. PICkit™ 1 Classic Software

2.1 INTRODUCTION

This chapter provides instructions on how to use the PICkit 1 Classic programming software to program 8 and 14-pin Mid-range (14-bit Core) Flash Microcontroller (MCU) Family devices.

2.2 USING PICKIT 1 CLASSIC PROGRAMMING SOFTWARE

Start the PICkit 1 Classic program by selecting *Start > Programs > PICkit 1 Flash Starter Kit > PICkit 1 Classic* . The programming interface appears as shown in Figure 2-1.

FIGURE 2-1: PICKIT 1 CLASSIC PROGRAMMING INTERFACE

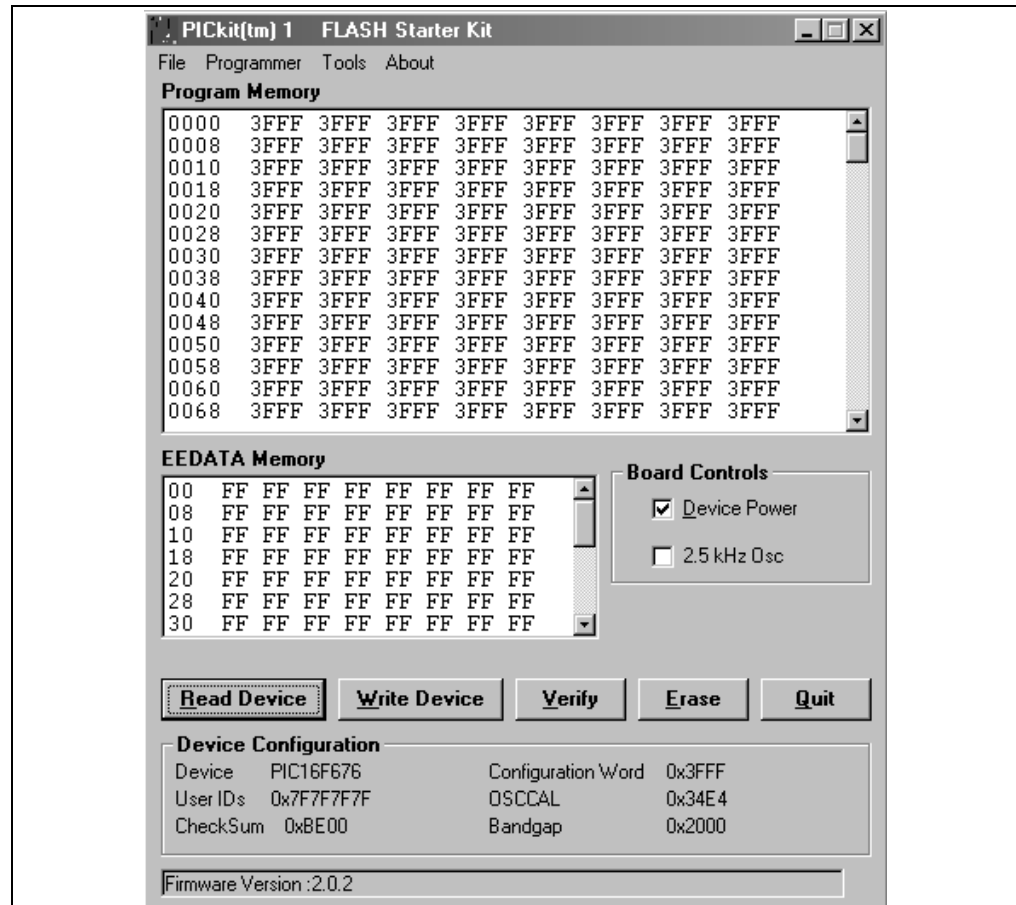

Notice that the Device Power check box is selected. This is a default function indicating the device power is turned on.

Note: To turn the device power off, deselect the check box.

PICKit™ 1 Flash Starter Kit User's Guide

2.2.1 Import HEX File

To import a compiled program (hex file), select *File > Import HEX*, as shown in Figure 2-2. Browse for the hex file and click **Open**.

FIGURE 2-2: IMPORT HEX FILE

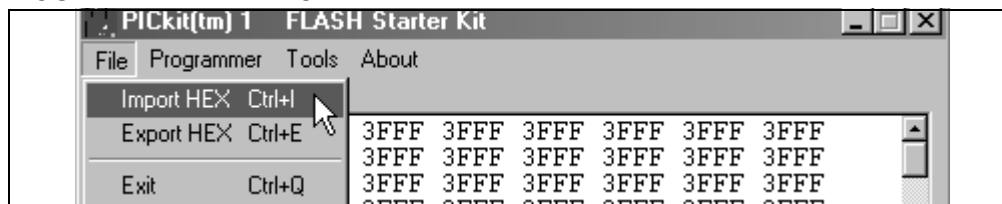

The code is displayed in the Program Memory and EEDATA Memory windows. (For more information on Program and EEDATA memory, see Lesson 5 and Lesson 6 in **Appendix C. “PIC12F675 Programming Projects”**.)

After the hex file is imported, write the program to the device by clicking the **Write Device** button. The existing program will be erased and replaced with the new one. The status of the program write is displayed in the status bar located at the bottom of the interface window.

If the write is successful, the status bar turns green and displays “Write Successful”, as shown in Figure 2-3.

FIGURE 2-3: WRITE SUCCESSFUL STATUS BAR

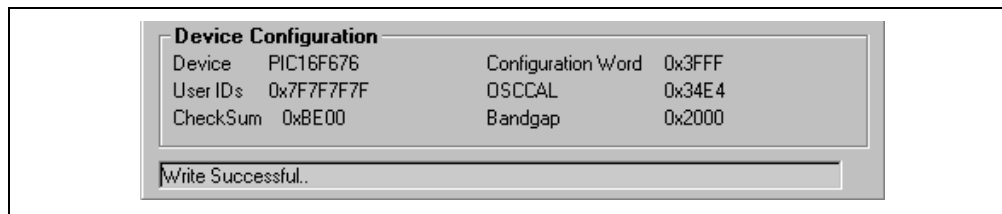

If the write fails, the status bar turns red and displays “Checksum verify failed”, as shown in Figure 2-4. This error indicates the data was corrupted during the programming sequence. If this error is displayed, try writing the program to the device again. If this error continues, see **Chapter 5. “Troubleshooting”** for assistance.

FIGURE 2-4: WRITE ERROR STATUS BAR

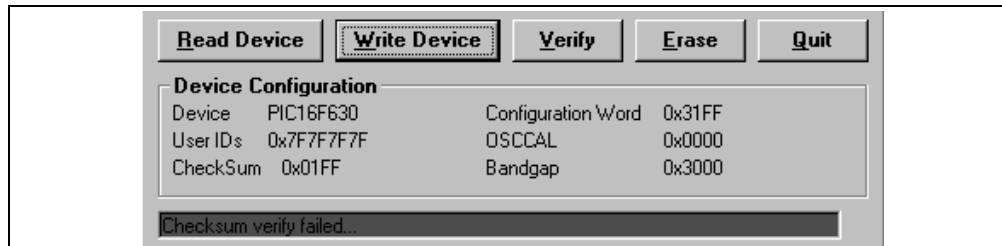

2.2.2 Automatic File Reload

Prior to each write, the imported hex file time stamp is compared to the version on the disk. If the version on the disk is newer, it is reloaded. This occurs only when a hex file has been read from the disk.

In the normal mode of operation, the hex file is updated with every build in MPLAB IDE. This ensures that the latest version built by MPLAB IDE will be written to the device.

2.2.3 Verify Program Code

This function verifies the program written to the device against a hex file. It compares all areas of memory including Program, EEDATA and Configuration.

To verify the code, import the hex file and click **Verify**. If the code is the same, the status bar turns green and displays “Verified successfully”, as shown in Figure 2-5.

FIGURE 2-5: VERIFY PROGRAM CODE STATUS BAR

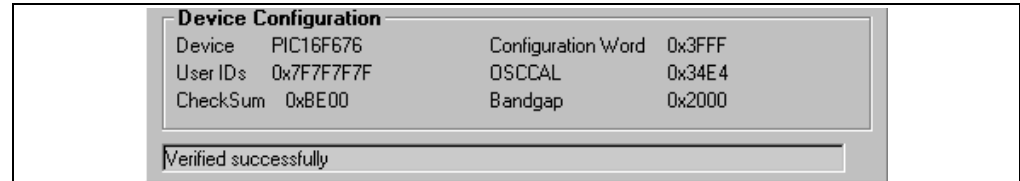

If a discrepancy is found, the status bar turns red and displays the error “Verify Failed... Error in program memory.”, as shown in Figure 2-6. If the Verify fails, it is possible that the device is code protected.

FIGURE 2-6: CODE ERROR STATUS BAR

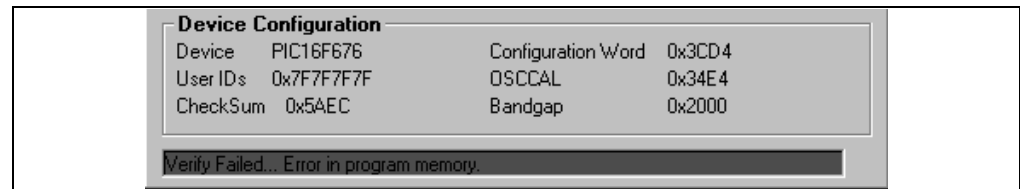

2.2.4 Read Device

To view the code written to the device, click **Read Device**. The code is displayed in the Program and EEDATA Memory windows for your review. If all zeros are displayed in the Program Memory window, it is possible that the device is code protected.

2.2.5 Code Protect Device

This function enables the code protection features of the device. To protect the code, complete the following steps:

1. Import the hex file.
2. Select *Tools > Code Protect Device*, as shown in Figure 2-7.
3. Click **Write Device**.

FIGURE 2-7: CODE PROTECT

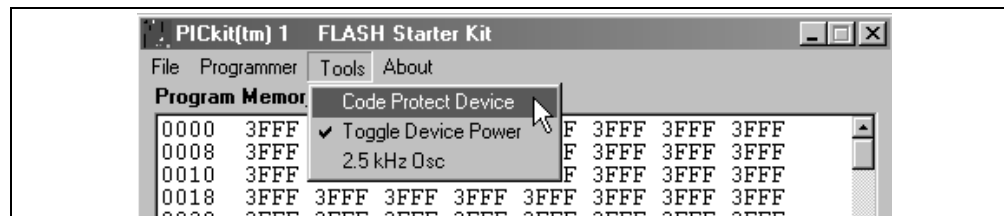

Note: If the device is read after it has been code protected, the Program and EEDATA Memory windows will display all zeros.

2.2.6 Erase

The Erase function erases code from the device. However, this function is not normally needed since the Write Device function performs an erase prior to writing code to the device.

To erase the device using the Erase function, click the **Erase** button or select *Programmer > Erase* from the toolbar menu, as shown in Figure 2-8.

FIGURE 2-8: DEVICE ERASE

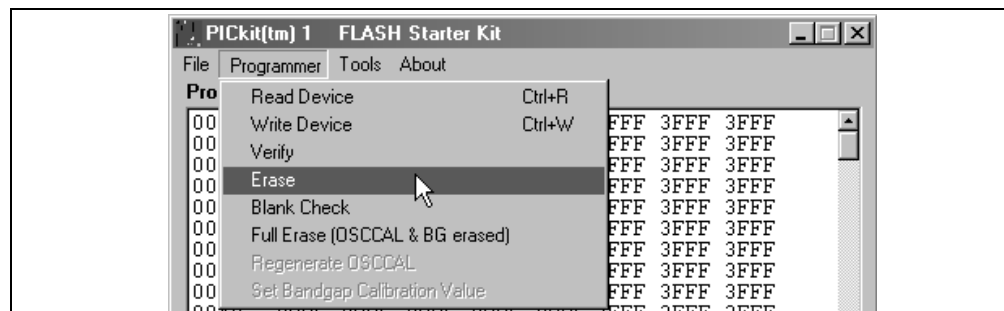

2.2.7 Full Erase

Unlike the Erase function, the Full Erase allows the user to erase not only the device, but the OSCCAL and bandgap calibration as well. Performing a full erase is not recommended or needed in the normal course of events. Only use this function if the OSCCAL or bandgap data has been corrupted.

To perform a full erase, select *Programmer > Full Erase (OSCCAL & BG erased)* from the toolbar menu, as shown in Figure 2-8.

Once the full erase is complete, regenerate the OSCCAL and reset the bandgap calibration value bits.

Note: The regenerated OSCCAL function runs a program on the device to recalculate the oscillator calibration value. See Lesson 7 in **Appendix C. "PIC12F675 Programming Projects"** for more details.

2.2.8 Regenerate OSCCAL

To regenerate the OSCCAL, select *Programmer > Regenerate OSCCAL* from the toolbar menu, as shown in Figure 2-9.

FIGURE 2-9: REGENERATE OSCCAL

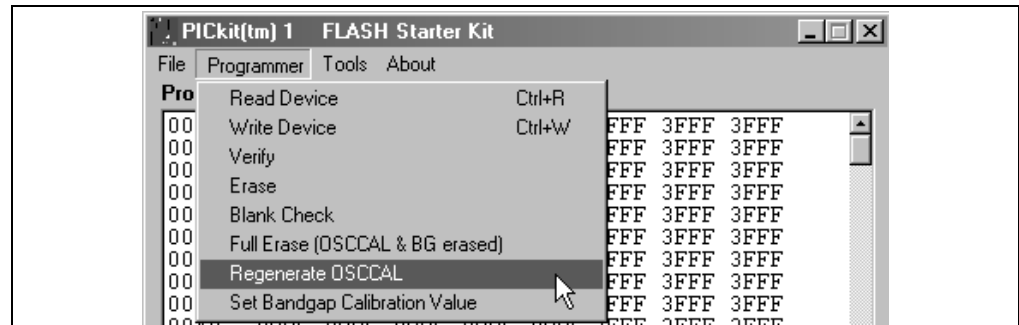

2.2.9 Set Bandgap Calibration Value

To set the bandgap calibration value, select *Programmer > Set Bandgap Calibration Value* from the toolbar menu, as shown in Figure 2-10.

FIGURE 2-10: REGENERATE BANDGAP CALIBRATION VALUE

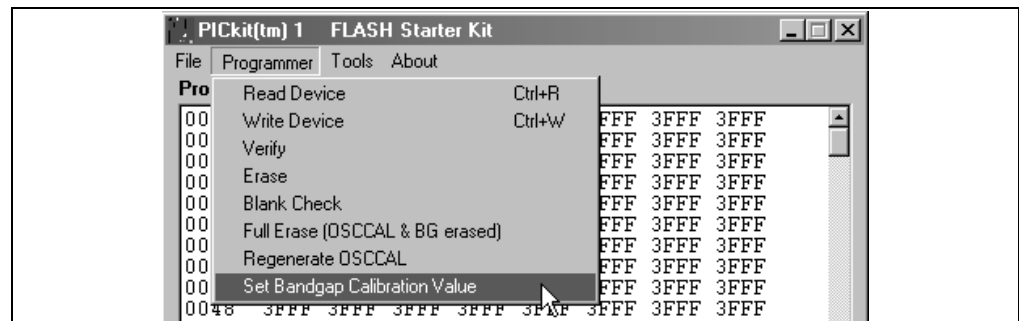

The Write Bandgap Calibration Value window will appear as shown in Figure 2-11. Select a bit value from the list and click OK.

FIGURE 2-11: SELECT BANDGAP BIT VALUE

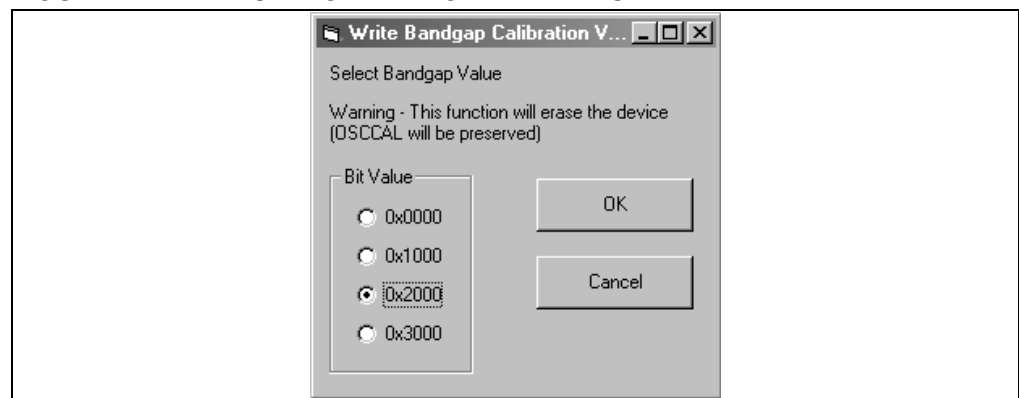

The bandgap bit value will appear in the Device Configuration box, as shown in Figure 2-12.

FIGURE 2-12: DEVICE CONFIGURATION

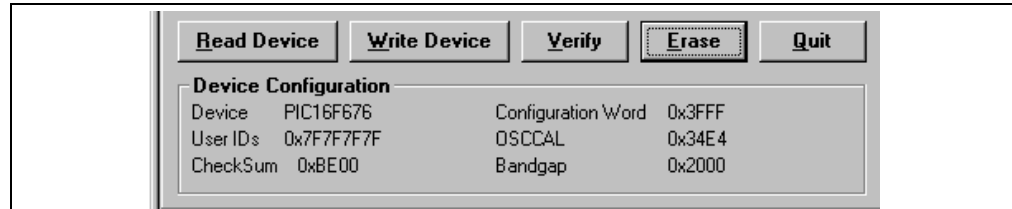

For more information on the OSCCAL and bandgap calibration, see the device data sheets located on the CDROM or the Microchip web site (www.microchip.com).

Note: The “Regenerated OSCCAL” and “Set Bandgap Calibration Value” functions are only available on the PIC12F629/675 and PIC16F630/676 devices.

2.2.10 2.5 kHz OSC

The 2.5 kHz OSC is a square wave signal that, when selected, is input to pin 3 of the evaluation socket. See the schematic Figure A-1 in Appendix A.

This function is used by Lesson 7 in **Appendix C. “PIC12F675 Programming Projects”**, and for OSCCAL regeneration.

FIGURE 2-13: BOARD CONTROLS

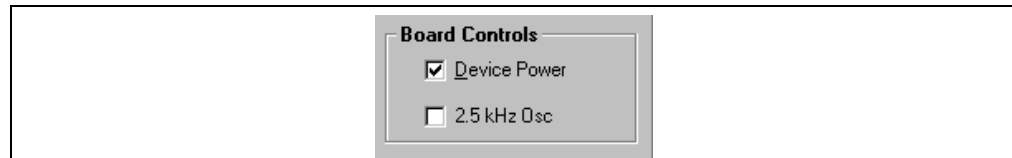

Chapter 3. PICkit™ 1 Baseline Flash Software

3.1 INTRODUCTION

This chapter provides instructions on how to use the PICkit 1 Baseline Flash programming software to program 6, 8 and 14-pin Baseline (12-bit Core) Flash Microcontroller (MCU) Family devices.

3.2 USING PICKIT 1 BASELINE FLASH PROGRAMMING SOFTWARE

Start the PICkit 1 Baseline Flash program by selecting *Start > Programs > PICkit(tm) 1 Flash Starter Kit > PICkit 1 Baseline Flash* . The programming interface appears, as shown in Figure 3-1.

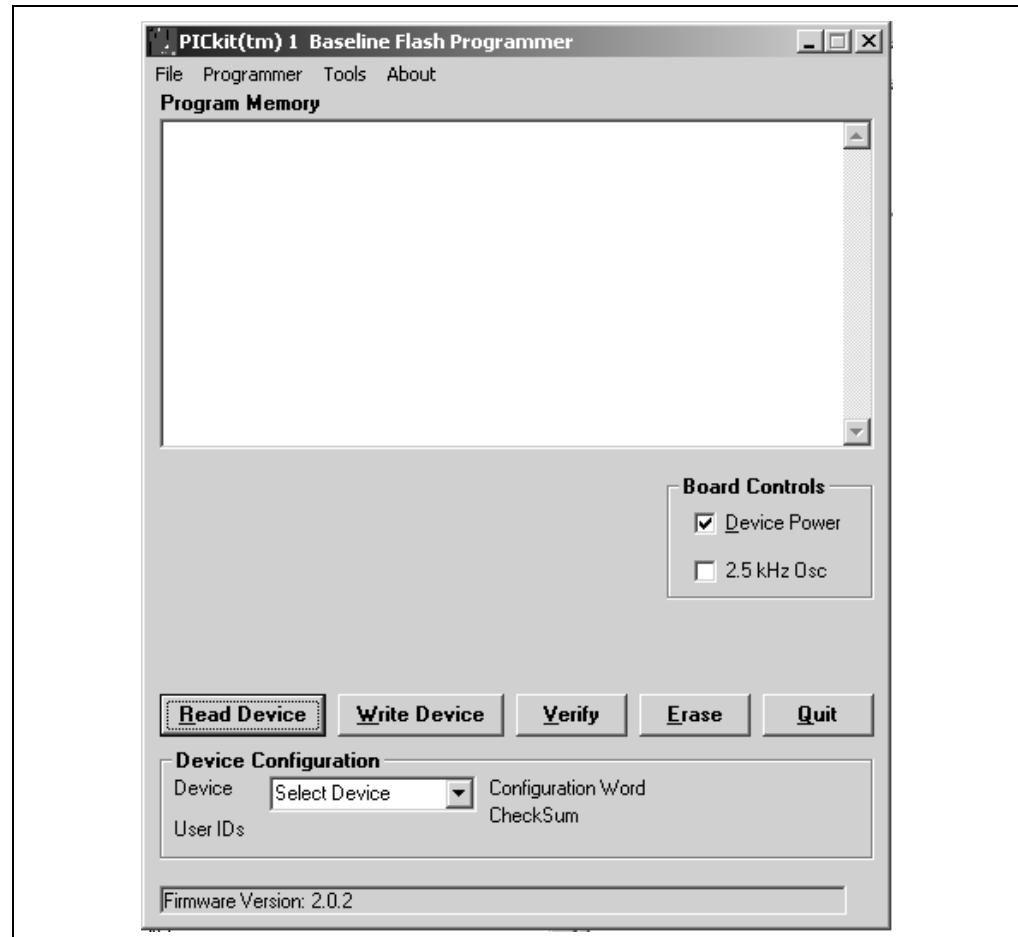
FIGURE 3-1: PICKIT 1 BASELINE FLASH PROGRAMMING INTERFACE

Notice that the Device Power check box is selected. This is a default function indicating the device power is turned on.

Note: To turn the device power off, deselect the check box.

PICKit™ 1 Flash Starter Kit User's Guide

3.2.1 Select Device

The user must first select the device intended for programming. Select the device by clicking on the **Device** drop-down menu, as shown in Figure 3-2. The drop-down menu lists the available devices that can be programmed by the PICKit 1 Baseline Flash programming software.

Note: Baseline (12-bit core) devices do not contain a Device ID. As a result, the PICKit 1 programming software cannot determine which device is in the evaluation socket of the PICKit 1 Flash Starter Kit. It is important that the user verify that the target device and the selected device match. Otherwise unintended results will happen.

FIGURE 3-2: SELECT DEVICE

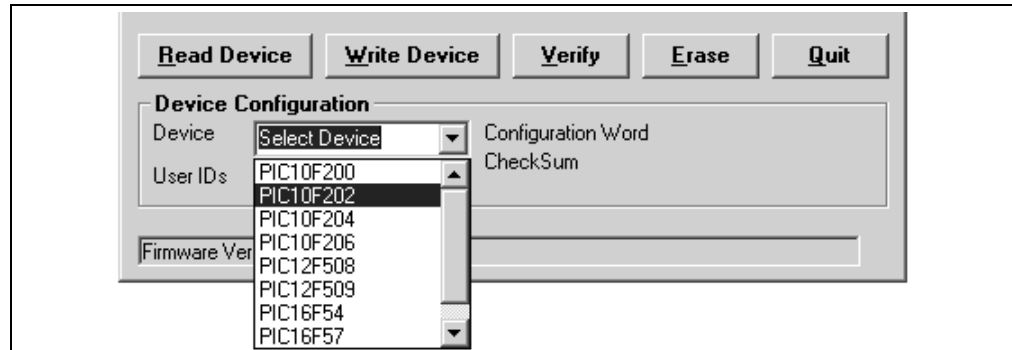

3.2.2 Import HEX File

To import a compiled program (hex file), select *File > Import HEX*, as shown in Figure 3-3. Browse for the hex file and click **Open**.

FIGURE 3-3: IMPORT HEX FILE

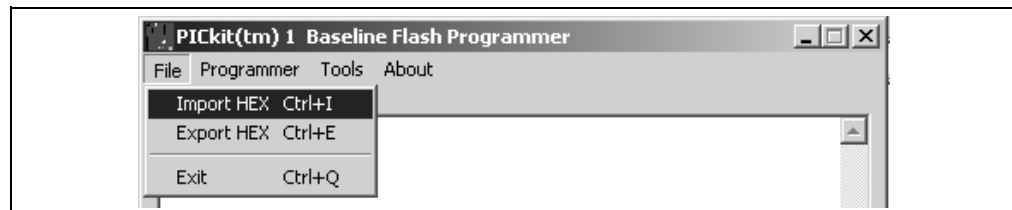

The code is displayed in the Program Memory window.

After the hex file is imported, write the program to the device by clicking the **Write Device** button. The existing program will be erased and replaced with the new one. The status of the program write is displayed in the status bar located at the bottom of the Interface window.

If the write is successful, the status bar turns green and displays "Write Successful", as shown in Figure 3-4.

FIGURE 3-4: WRITE SUCCESSFUL STATUS BAR

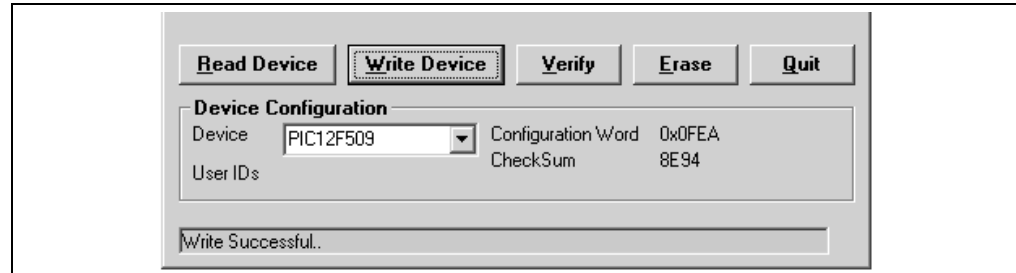

If the write fails, the status bar turns red and displays “Checksum verify failed”, as shown in Figure 3-5. This error indicates the data was corrupted during the programming sequence. If this error is displayed, write the program to the device again. If this error continues, see **Chapter 5. “Troubleshooting”** for assistance.

FIGURE 3-5: WRITE ERROR STATUS BAR

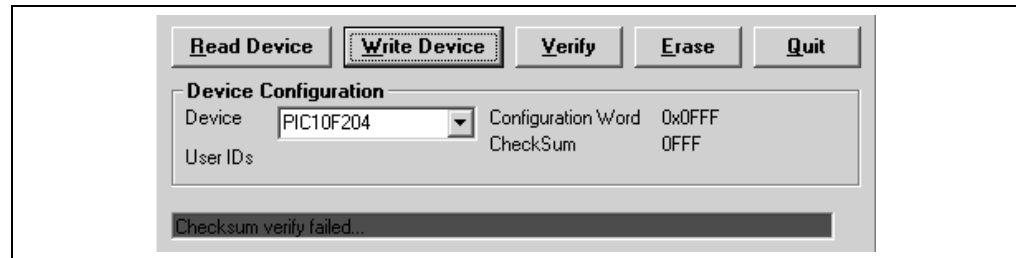

3.2.3 Automatic File Reload

Prior to each write, the imported hex file time stamp is compared to the version on the disk. If the version on the disk is newer, it is reloaded. This occurs only when a hex file has been read from the disk.

In the normal mode of operation, the hex file is updated with every build in MPLAB IDE. This ensures that the latest version built by MPLAB IDE will be written to the device.

3.2.4 Verify Program Code

This function verifies the program written to the device against a hex file. It compares all areas of memory including Program and Configuration.

To verify the code, import the hex file and click **Verify**. If the code is the same, the status bar turns green and displays “Verified successfully”, as shown in Figure 3-6.

FIGURE 3-6: VERIFY PROGRAM CODE STATUS BAR

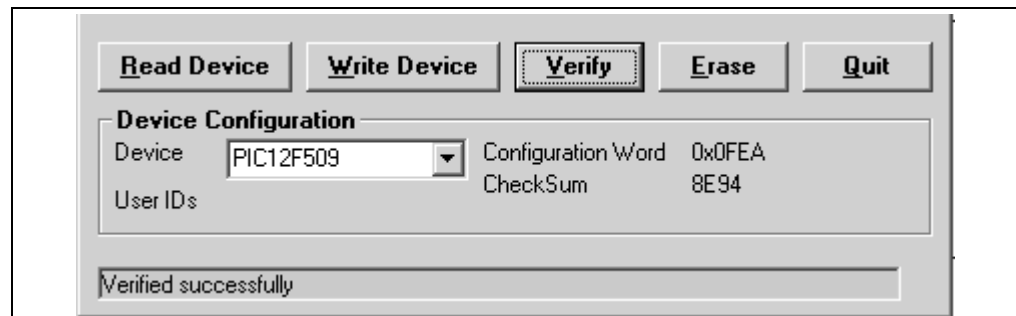

If a discrepancy is found, the status bar turns red and displays the error “Verify Failed Error in program memory”, as shown in Figure 3-7.

FIGURE 3-7: VERIFY PROGRAM CODE ERROR STATUS BAR

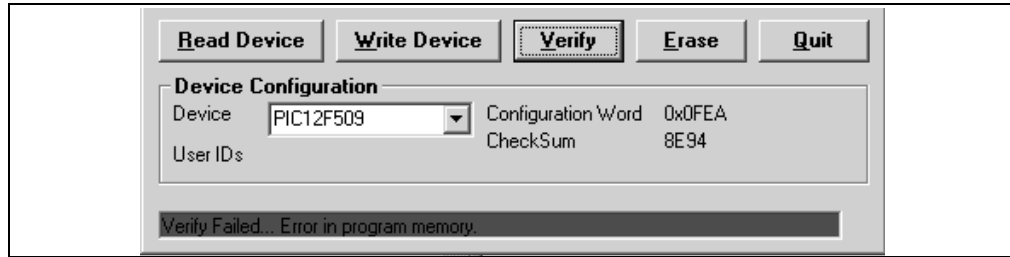

3.2.5 Read Device

To view the code written to the device, click **Read Device**. The code is displayed in the Program Memory windows for your review.

3.2.6 Code Protect Device

This function enables the code protection features of the device. To protect the code, complete the following steps:

1. Import the hex file.
2. Select *Tools > Code Protect Device*, as shown in Figure 3-8.
3. Click **Write Device**.

FIGURE 3-8: CODE PROTECT DEVICE

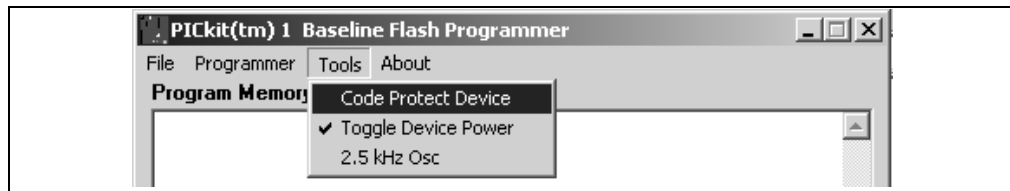

Note: If the device is read after it has been code protected, the Program Memory window displays all zeros.

3.2.7 Erase

The Erase function erases code from the device. However, this function is not normally needed since the Write Device function performs an erase prior to writing code to the device.

To erase the device using the Erase function, click the **Erase** button, or select *Programmer > Erase* from the toolbar menu, as shown in Figure 3-9.

FIGURE 3-9: ERASE

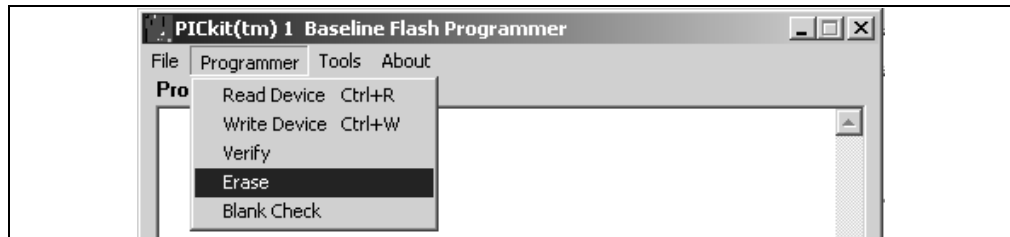

3.2.8 2.5 kHz OSC

The 2.5 kHz OSC is a square wave signal that, when selected, is input to pin 3 of the evaluation socket. See the schematic Figure A-1 in the Appendix A.

FIGURE 3-10: BOARD CONTROLS

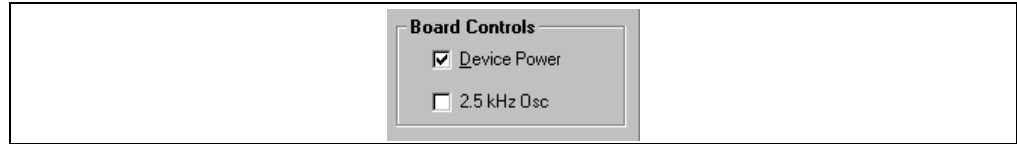

PICkit™ 1 Flash Starter Kit User's Guide

NOTES:

Chapter 4. PICkit™ 1 and MPLAB® IDE

4.1 INTRODUCTION

This chapter provides a quick overview on how to create and load a project in MPLAB IDE and program a device with MPLAB IDE. The PIC12F675 programming projects described in **Appendix C. “PIC12F675 Programming Projects”** are used as examples in this chapter.

Detail information on MPLAB IDE can be found in the “*MPLAB® IDE v6.xx Quick Start Guide*”, (DS51025) available on the MPLAB IDE CD-ROM included in the kit or from the Microchip Technology Inc. website (<http://www.microchip.com>).

MPLAB IDE is the integrated development environment supplied by Microchip Technology Inc. for developing software for PIC® microcontrollers. MPLAB IDE is used to:

- Create source code using the built-in editor.
- Assemble, compile and link source code using various language tools. An assembler, linker and librarian come with MPLAB IDE. Supported C compilers are available from Microchip. Third party compilers may be supported also. Check the release notes or readme files for details.
- Debug the executable logic by watching program flow with the built-in simulator, or in real time with the MPLAB ICE 2000 emulator or MPLAB ICD 2 in-circuit debugger. Third party emulators may also be supported. Check the release notes or readme files for details.
- Make timing measurements with the simulator or emulator.
- View variables in watch windows.

4.2 HIGHLIGHTS

- Using the PIC12F675 Programming Project Source Code
- Project Management in MPLAB IDE

4.3 USING THE PIC12F675 PROGRAMMING PROJECT SOURCE CODE

If the PIC12F675 Programming Project source code was installed from the PICkit 1 CDROM, and “Lessons” was selected from the options list, the source and hex files will be installed on the PC harddrive at:

```
C:\PICkit 1\Classic\Lesson n
```

Where n indicates the lesson number.

In order to use the lesson source code you will have to:

1. Create a new or open an existing MPLAB IDE project.
2. Configure the project for the PIC12F675.
3. Add the code to the project.
4. Compile the software.

Details for each of these steps can be found on the “*MPLAB® IDE v6.xx Quick Start Guide*” available on the MPLAB IDE CD-ROM included with the PICkit 1 Flash Starter Kit.

PICkit™ 1 Flash Starter Kit User's Guide

4.4 PROJECT MANAGEMENT IN MPLAB IDE

Work in MPLAB IDE is done by creating or loading a project. A project contains all the information needed to write, compile and program a PICmicro MCU device.

4.4.1 Creating a Project

1. Select *Project > Project Wizard*, as shown in Figure 4-2.
2. Follow the steps in the wizard to create a project.

FIGURE 4-1: CREATING A PROJECT



4.4.2 Opening a Project

Opening a project in MPLAB IDE is accomplished with the following steps:

1. Select *Project > Open*, as shown in Figure 4-2.
2. Browse and locate the project.
3. Click **OPEN**.

FIGURE 4-2: OPENING A PROJECT

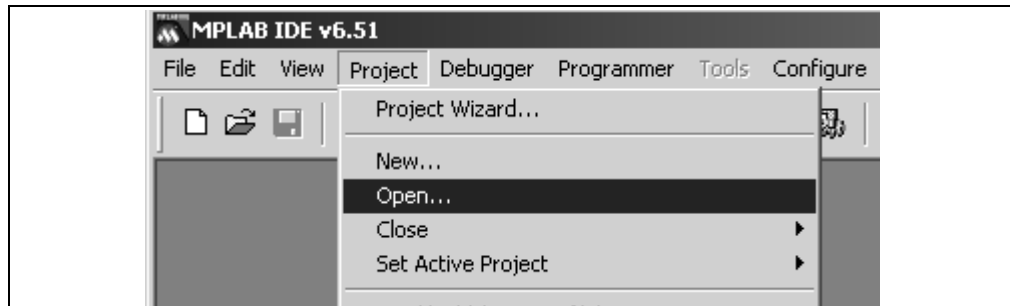

4.4.3 Compiling the Project

After creating or opening a project, it is necessary to compile it. Select *Project > Make*, as shown in Figure 4-3.

A window will appear and show the progress. If there are no errors, the program can be simulated or programmed into the PICkit 1 Flash Starter Kit software. (See **Section 4.4.5 “Programming the Device from MPLAB IDE”**).

FIGURE 4-3: COMPILE PROJECT

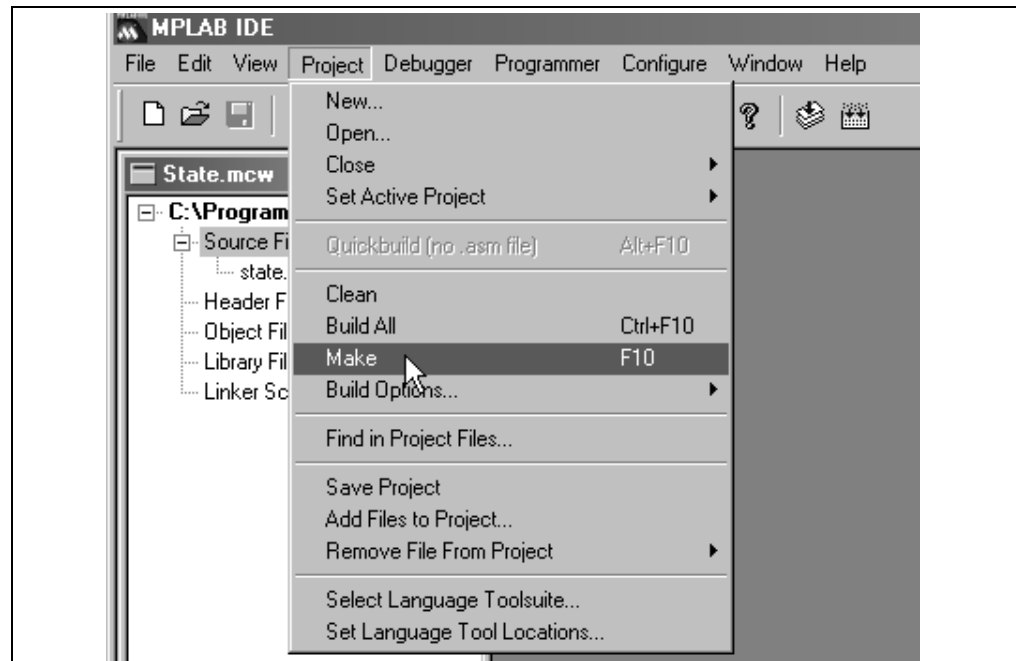

4.4.4 Simulating the Project

In order to simulate the program to see what the PIC microcontroller is actually doing with each instruction, select the MPLAB IDE simulator debugger. Select *Debugger > Select Tool > MPLAB SIM*, as shown in Figure 4-4.

FIGURE 4-4: MPLAB SIMULATION

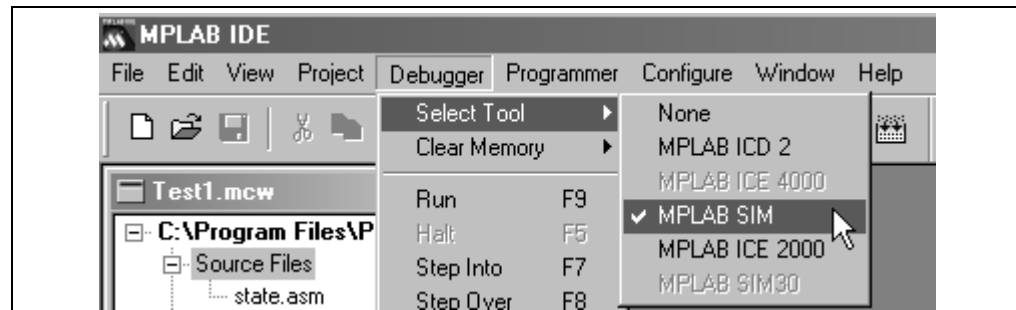



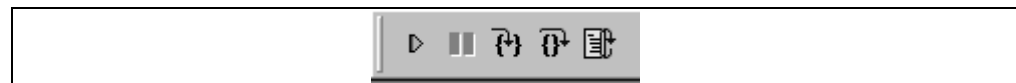

Once MPLAB SIM is selected, five buttons will appear on the right end of the menu toolbar, as shown in Figure 4-5.

FIGURE 4-5: SIMULATION TOOLBAR



These buttons allow the user to:

1. Run code: 
2. Pause code: 
3. Single Step code, step into functions: 
4. Single Step code, step over functions: 
5. Reset code: 

PICKit™ 1 Flash Starter Kit User's Guide

To view the code in single steps, press the single step button. The code window will show the instruction that will be executed next, as shown in Figure 4-6.

FIGURE 4-6: CODE WINDOW

```
*****  
    ORG    0x000        ; processor reset vector  
    nop                    ; Inserted For ICD2 Use  
    goto   Init         ; go to beginning of program  
*****
```

In the View toolbar menu there are options to view the special function registers, program memory and other useful information, as shown in Figure 4-7.

FIGURE 4-7: VIEW MENU OPTIONS

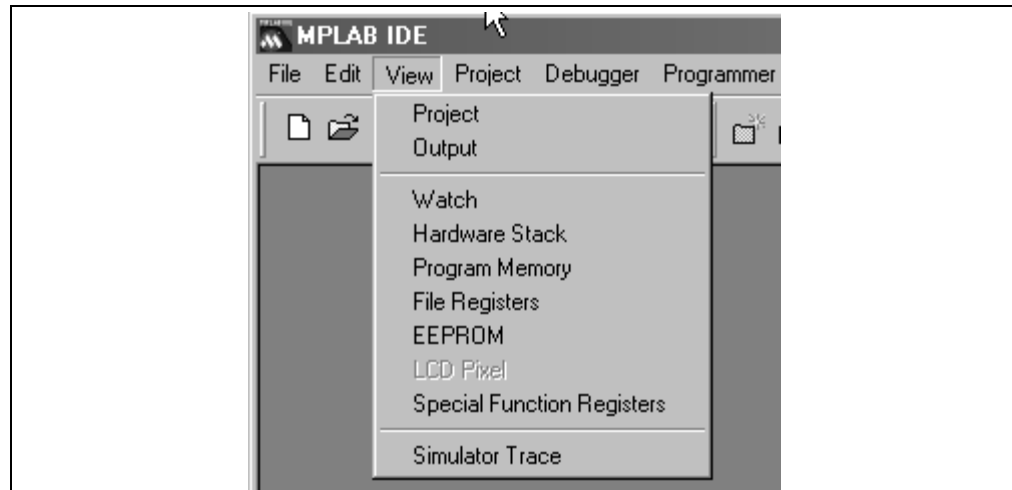

4.4.5 Programming the Device from MPLAB IDE

The device can be programmed from MPLAB IDE by selecting PICKit 1 as the programmer as shown in Figure 4-8. The Output window will report the firmware version if the PICKit 1 is plugged into the computer via the USB port. The Output window will also report any errors encountered in the selection or programming of the device.

FIGURE 4-8: SELECTING PICKit 1 AS PROGRAMMER

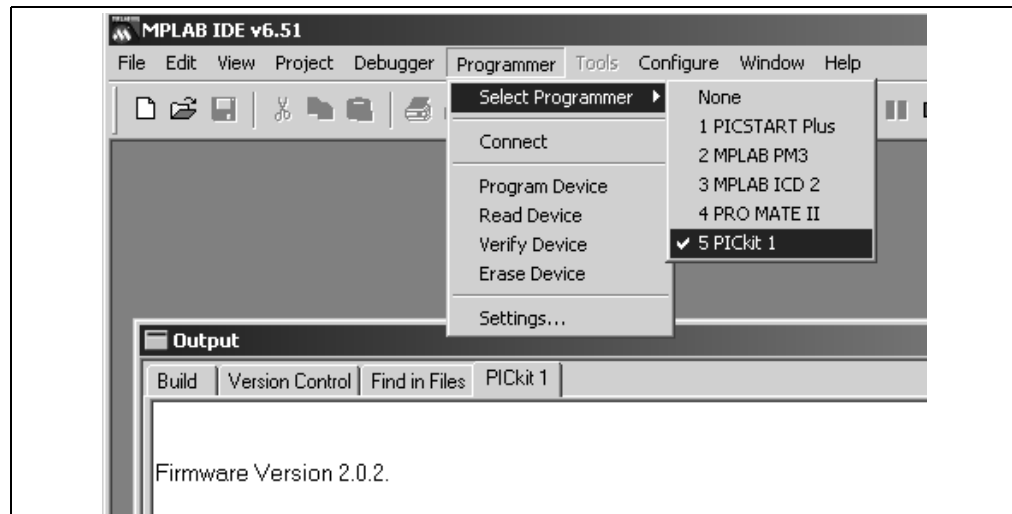

Chapter 5. Troubleshooting

5.1 INTRODUCTION

This chapter describes common problems and possible solutions for solving problems with the PICKit 1 Flash Starter Kit.

5.2 FAQs

5.2.1 Program Does Not Work

Question:

My program does not work. What should I check?

Answer:

1. Are the configuration bits set in the source file? PICKit 1 Flash Starter Kit depends on having the configuration bits set in the hex file. The assembler uses the `_CONFIG` directive. When using the PICKit 1 Flash Starter Kit's on-board evaluation socket, configure the internal oscillator. The internal oscillator also frees up two more pins for general I/O use.

The assembler directive to select the internal oscillator, with all other functions off, might look like this:

```
_CONFIG (_INTRC_OSC_NOCLKOUT & _WDT_OFF & _BODEN_OFF&_CP_OFF  
&_CPD_OFF)
```

The following code shows how to set the configuration bits in Hi-Tech C:

```
_CONFIG(UNPROTECT & BOREN & MCLRDIS & PWRTEN & WDTDIS & INTIO);
```

2. Are the pins multiplexed with other functions? If so, does the program initialize the control registers to select the function desired? A common problem occurs on PORTA where the analog inputs to the ADC are multiplexed with digital functions. The pins default to analog input. For digital output, write to the ANSEL register and make the pins digital I/O.

5.2.2 Device Will Not Program

Question:

The device will not program. All writes end with a "checksum verified failed" error message.

Answer:

1. Are the code protect bits set in the source code file? Currently, the device can only be code protected by selecting the *Tools > Code Protect Device* option in the PICKit 1 user's interface.
2. The part may be damaged. Try another device.

5.2.3 Device Is Not Recognized

Question:

Receiving message “Insert Device”, but there is a part in the socket.

Answer:

1. Verify the device in the socket is a PICmicro MCU supported by the PICKit 1 Classic or Baseline Flash program.
2. Check for additional circuits attached to pins GP0 and GP1.
3. Check to see if the SW1 switch is pressed.

5.2.4 Current Limit Exceeded

Question:

Receiving error message “USB Hub Current Limit Exceeded” from Microsoft Windows 2000.

Answer:

Check for shorts on the circuit board.

FIGURE 5-1: USB HUB CURRENT LIMIT EXCEEDED

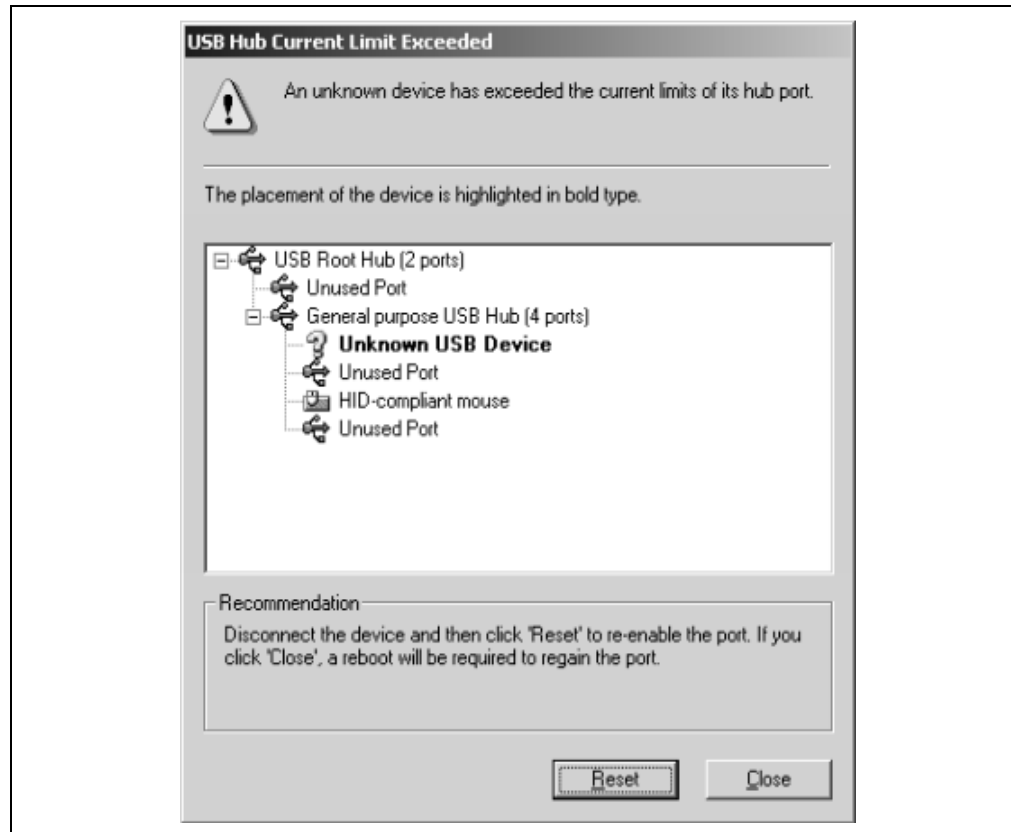

5.2.5 Windows Driver

Question:

After plugging the PICkit 1 into the USB port, Windows 98 SE asks for a driver. Where is the driver?

Answer:

PICkit 1 uses the drivers included with Windows. When Windows 98 SE prompts for a driver, select “**Search for the best driver for your device.**” Then select the check box next to “**Microsoft Windows Update**” and click **Next**. Windows will automatically install the appropriate driver. Do not use the ICD 2 USB driver.

5.2.6 Editing Device Memory

Question:

When using the PICkit 1 user’s interface to edit the actual contents of the memory, it will not allow date selection. Why not?

Answer:

The PICkit 1 User’s Interface was developed to program a device. It was not intended to edit the contents of a device. Please use MPLAB IDE to edit the contents of the device. The data in the window can be selected to cut and paste into another editor for use in other applications.

5.2.7 No Source Code

Question:

After moving the tutorial data files to a different location on the hard drive, the MPLAB IDE simulator behaves strangely. When stepping through the code, a Program Memory window is displayed without the source code. What is wrong?

Answer:

The MPLAB simulator does not support source level debugging when the path to the source code is > 62 characters long. Moving the data files to a location with a shorter path name will fix the problem.

5.2.8 HI-TECH PICC LITE™ C Compiler

Question:

Why does the default demonstration code not work correctly after compiling with the Hi-Tech PICC LITE™ C Compiler?

Answer:

Download the latest Hi-Tech PICC LITE™ C Compiler from the Hi-Tech web site www.htsoft.com.

5.2.9 Verify and Read Device Return all Zeros

Question:

When the Verify or Read Device buttons are pushed, the Program Memory window comes up with all zeros. What is wrong?

Answer:

The device may be code protected. Ensure code protection has not been selected in the configuration word.

PICKit™ 1 Flash Starter Kit User's Guide

NOTES:

Appendix A. Hardware Description

A.1 INTRODUCTION

This appendix contains the PICKit™ 1 hardware description and schematic diagrams.

A.2 HIGHLIGHTS

This appendix discusses:

- In-Circuit Serial Programming™ (ICSP™)
- Programming Hardware
- USB Communications Protocol
- Schematic Diagrams:
 - PICKit 1 Board Diagram
 - LED Layout
 - VPP Supply
 - USB Control
 - Prototype 1
 - Prototype 2

A.3 IN-CIRCUIT SERIAL PROGRAMMING™ (ICSP™)

In-Circuit Serial Programming (ICSP) allows an engineer to design a circuit that will be built and then programmed later. ICSP is described in the programming specifications documentation. These documents can be found on the Microchip web site (<http://www.microchip.com>). ICSP requires a 12-13V power supply, control of the VDD supply and two I/O pins to clock in commands and data.

A.4 PROGRAMMING HARDWARE

The programmer portion of the PICKit 1 Flash Starter Kit circuit is shown in Figure A-1. Additional circuitry is present to connect to the USB and drive the evaluation LEDs. Most of the circuitry in the figure is used to generate the +13V required for VPP. This is generated by using the CCP of the PIC16C745 to pulse Q2 on and off. By pulsing Q2, L1 generates a burst of charge that is steered into the capacitor C4 by the diode D13. Each burst of charge adds to the voltage already in the capacitor. The size of the burst of charge is proportional to the on time of the PWM signal from CCP. The resistors R10 and R11 form a voltage divider that drops the 13V VPP to a 4.5V feedback signal that is measured by AN1. Software running in the PIC16C745 periodically samples AN1 and computes a new PWM value. The PWM value is updated just over 500 times every second. This ensures good voltage regulation of the 13V and leaves enough CPU time to perform the programming task. The rest of the circuit is used to switch the VPP voltage to the VPP pin. Transistor Q4 is the switch for the VPP voltage and Q3 is the driver for Q4. Transistor Q1 turns VDD on and off allowing the target device to be reset. The programming I/O signals are generated by software routines on I/O port pins RC6 and RC7 of the PIC16C745, which drive I/O port pins RA0/GP0 (ICSPDAT) and RA1/GP1 (ICSPCLK) of the target 8 or 14-pin Flash device.

PICkit™ 1 Flash Starter Kit User's Guide

FIGURE A-1: PROGRAMMING HARDWARE

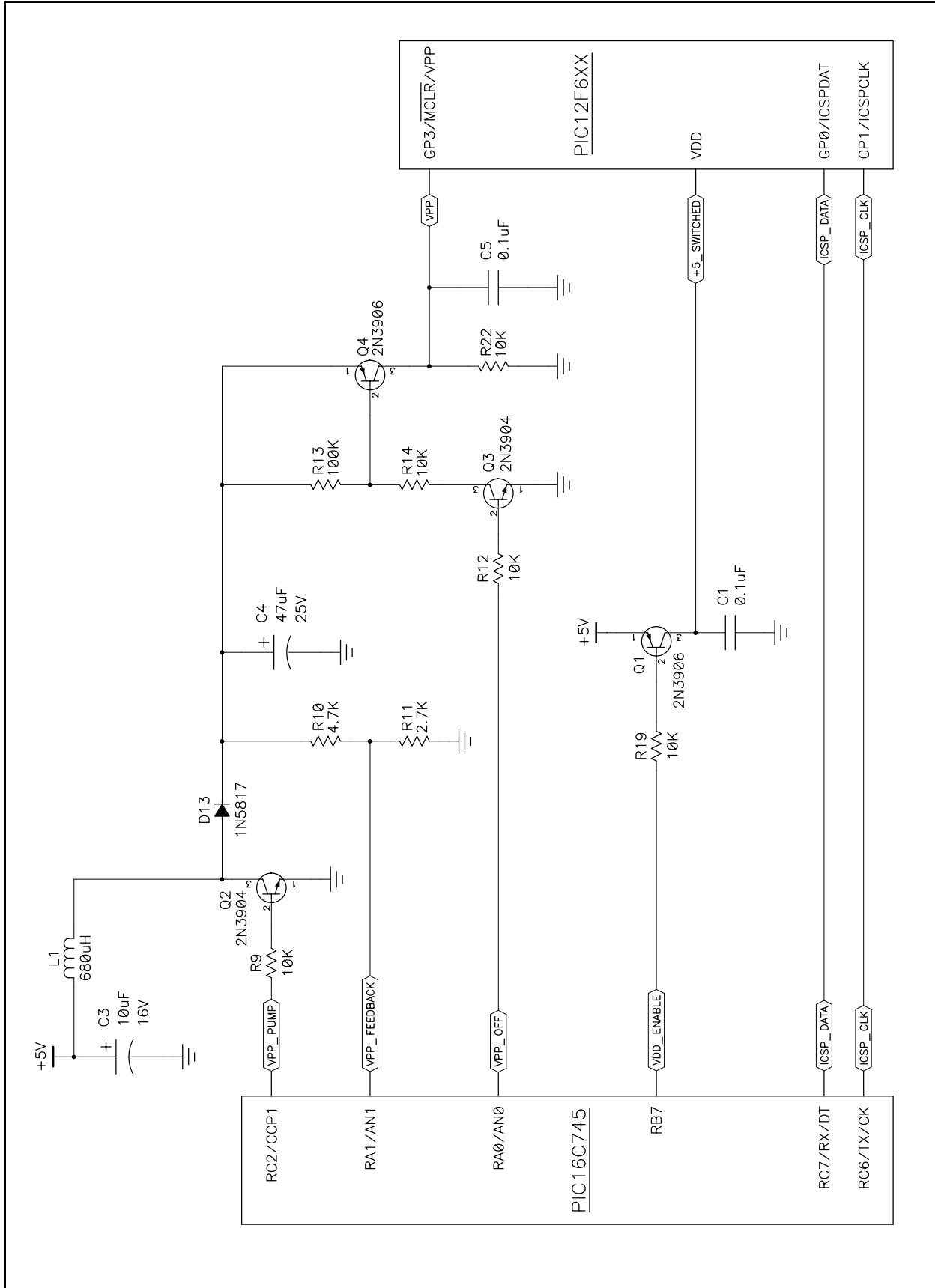

A.5 USB COMMUNICATIONS PROTOCOL

The USB protocol used by the PICkit 1 Flash Starter Kit is a very simple command/response type protocol. Multiple commands can be put together to fill the 8 bytes of a USB packet. If a command cannot fill the 8 bytes and it is not desired to use a second command to fill the packet, the packet should be padded with 'Z' to indicate no operation.

A.5.1 Commands

- 'C' <word> – Configuration Memory Write mode. Word parameter ignored. Use 'W' to write to configuration memory.
- 'c' – Download Command Table. 15 bytes to follow (two 8 byte packets) containing the 6-bit commands in the following order:
 - Load Configuration memory
 - Load data for Program memory
 - Load data for EE Data memory
 - Read data from Program memory
 - Increment Address
 - Begin programming (internally timed)
 - Begin programming (externally timed)
 - End programming (externally timed)
 - Bulk Erase Program memory
 - Bulk Erase EE Data memory

The last 4 commands are undefined but the second data packet will be filled out.

- 'D' <byte> – Write EE Data memory. Data is passed as the byte.
- 'E' – Bulk Erase Program memory
- 'e' – Bulk Erase Data memory
- 'g' – Get n bytes from device (n is a word)
- 'I' <word> – Increment Address N times. N is passed as word.
- 'P' – Enter Programming mode. Turns VPP and VDD on.
- 'p' – Exit Programming mode. Turns VDD and VPP off.
- 'R' – Read Program memory. 'R' always returns 4 words. If the end of PGM memory is reached, it pads with 0's. It is the responsibility of the host software to determine if padding occurred by keeping track of the program counter.
- 'r' – Read EE Data memory. 'r' always returns 8 bytes. If the end of Data memory is reached, it pads with 0's. It is the responsibility of the host software to determine if padding occurred by keeping track of the program counter.
- 'S' <program memory length, data memory length> – Calculates Program Memory Checksum and Data Memory Checksum. The checksum is calculated on the first N_p words of the program memory and the first N_d bytes of the data memory. N_p and N_d are both words passed as the length parameter. The return value is 3 bytes in length: the first word is the Program Memory Checksum, and the last byte is the Data Memory Checksum.
- 't' – Transmit n bytes to device (n is a word)
- 'V' <byte> – Power and special feature control. The byte following command is used to control. VDD power to the target and to enable/disable a 2.5 kHz 50% square wave.
- 'v' – Return version information. The following bytes are returned: <Major><Minor><Dot>.
- 'W' <word> – Write Program Memory. Loads the write latch, sends the write command and increments to the next address.

PICKit™ 1 Flash Starter Kit User's Guide

- 'w' – Externally timed write. Loads a word into the write latches, starts the programming cycle, ends the programming cycle 5 mS later and increments the PC.
- 'Z' – No operation. Use to pad packets to 8 bytes.
- '4' – 4 word write. Loads 4 words prior to write cycle. The 4 14-bit words are packed into the remaining 7 bytes. The first three words are sent low byte/high byte. This occupies bytes 1-6 of the packet. The low byte of the fourth word is sent in byte 7. The high-order 6 bits are sent using the unused bits of the other 3 high order bytes, as follows:.

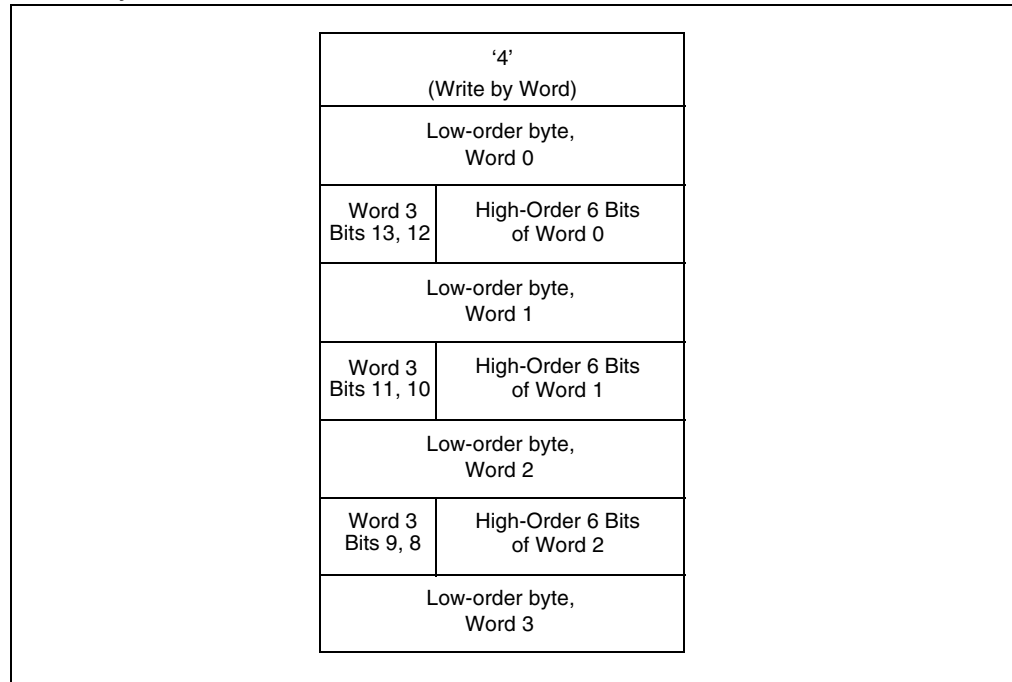

Note: Word values are sent low byte first.

Source code for the PC host programs are located on the PICKit 1 Flash Starter Kit CDROM in the unsupported directory.

A.6 SCHEMATIC DIAGRAMS

FIGURE A-1: PICKIT™ 1 BOARD DIAGRAM

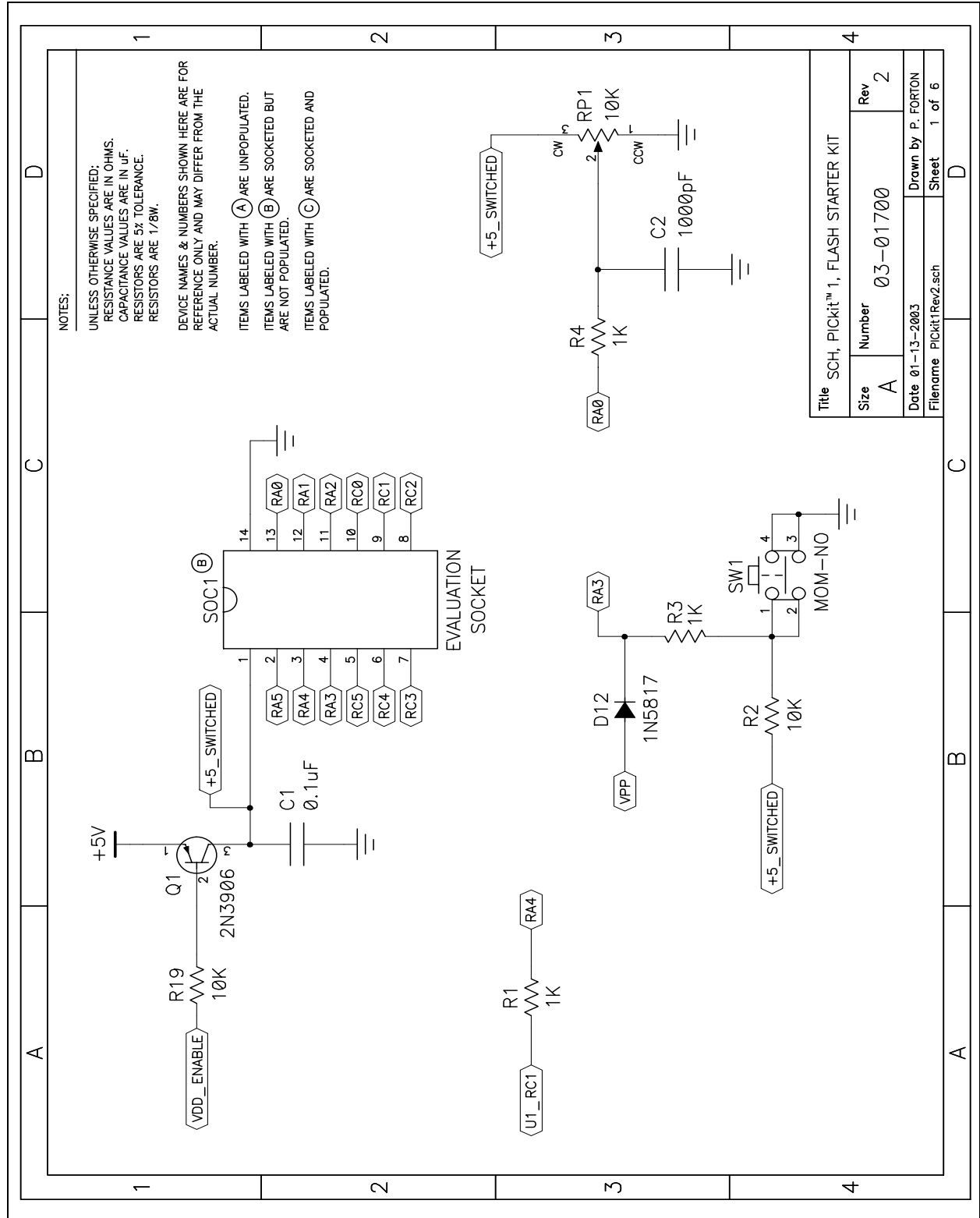

PICKit™ 1 Flash Starter Kit User's Guide

FIGURE A-2: LED LAYOUT

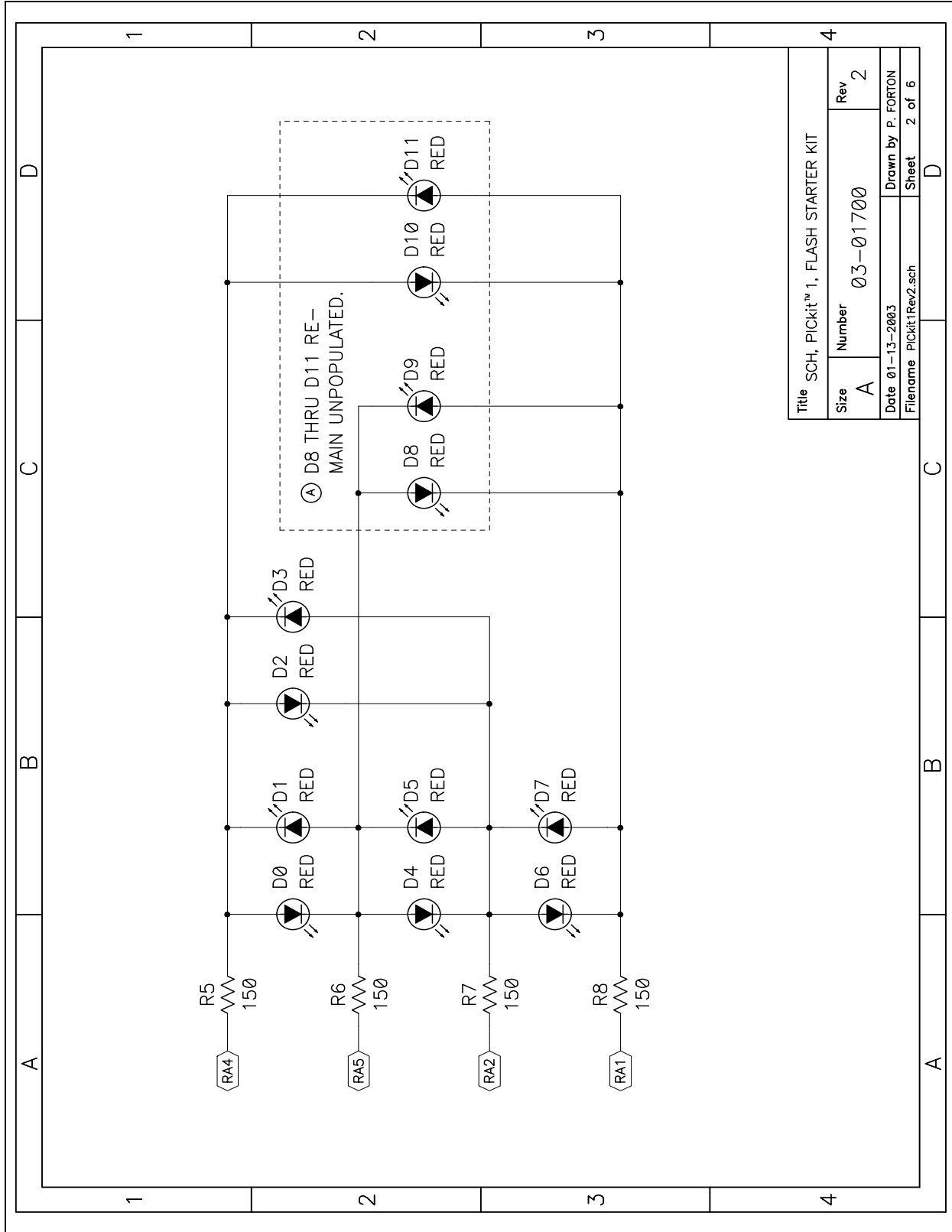
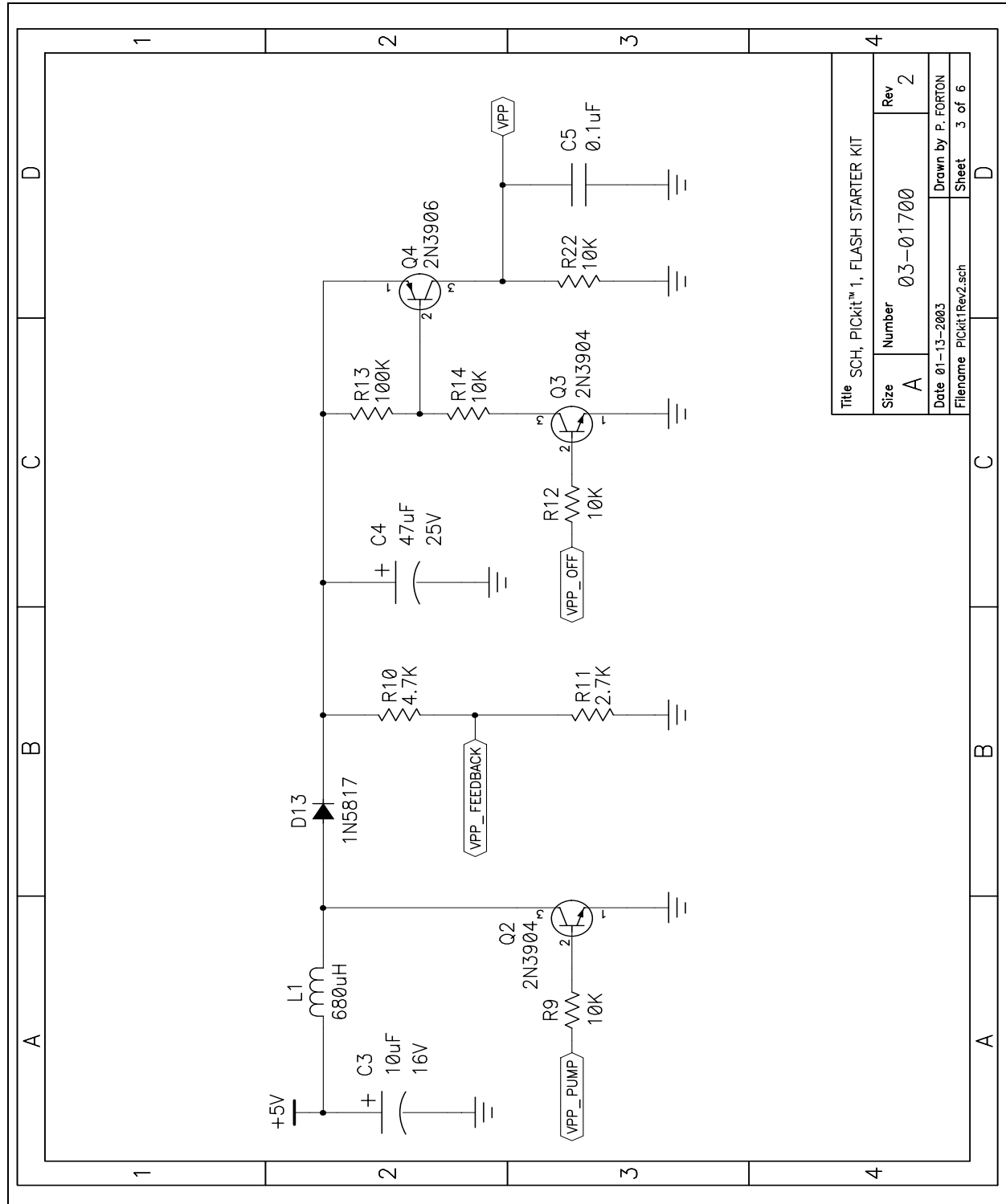

FIGURE A-3: VPP SUPPLY



Title		SCH, PICKIT™ 1, FLASH STARTER KIT	
Size	Number	Rev	2
A	03-01700		
Date 01-13-2003		Drawn by P. FORTON	
Filename PICKIT1Rev2.sch		Sheet 3 of 6	

PICKit™ 1 Flash Starter Kit User's Guide

FIGURE A-4: USB CONTROL

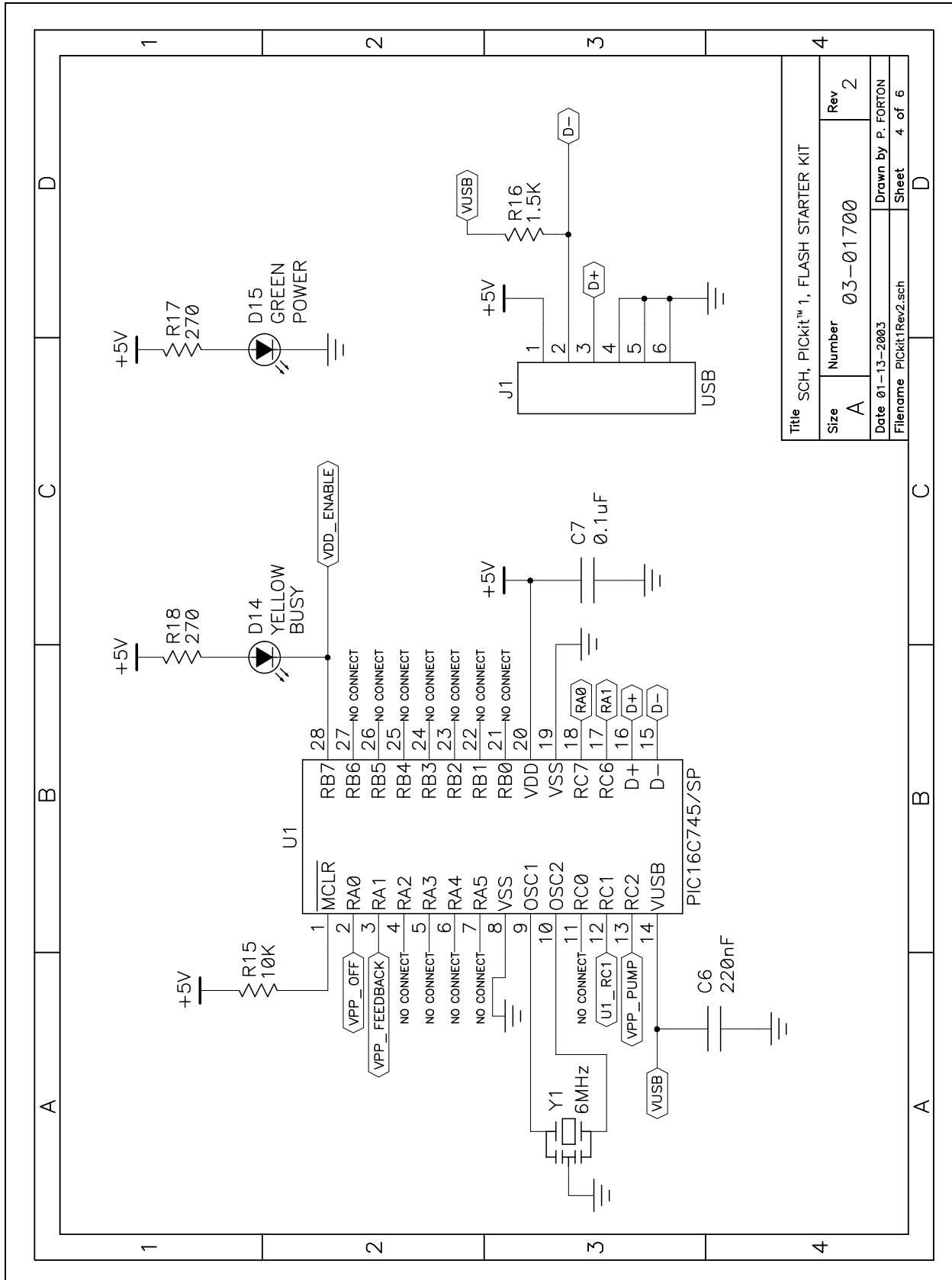
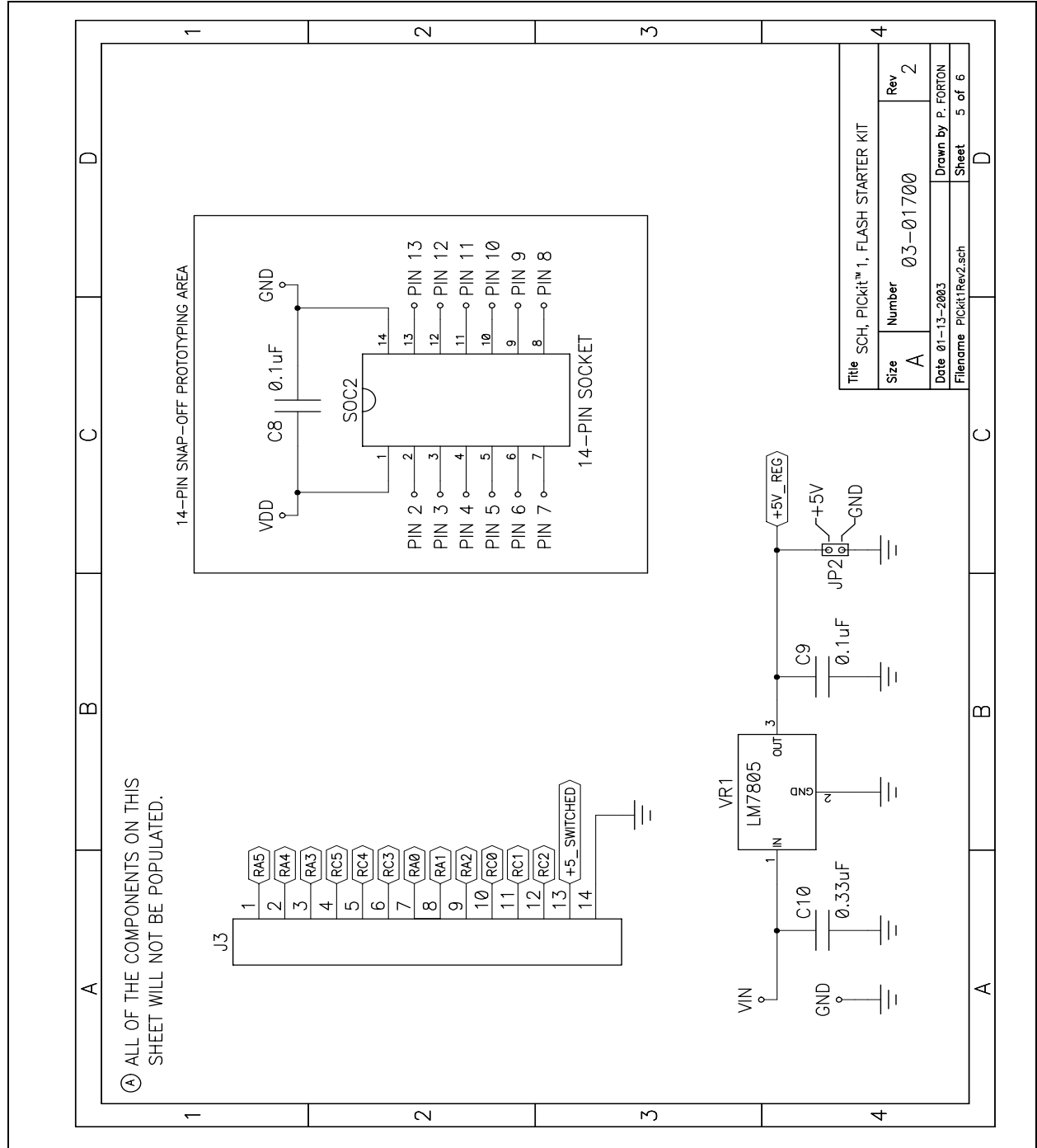
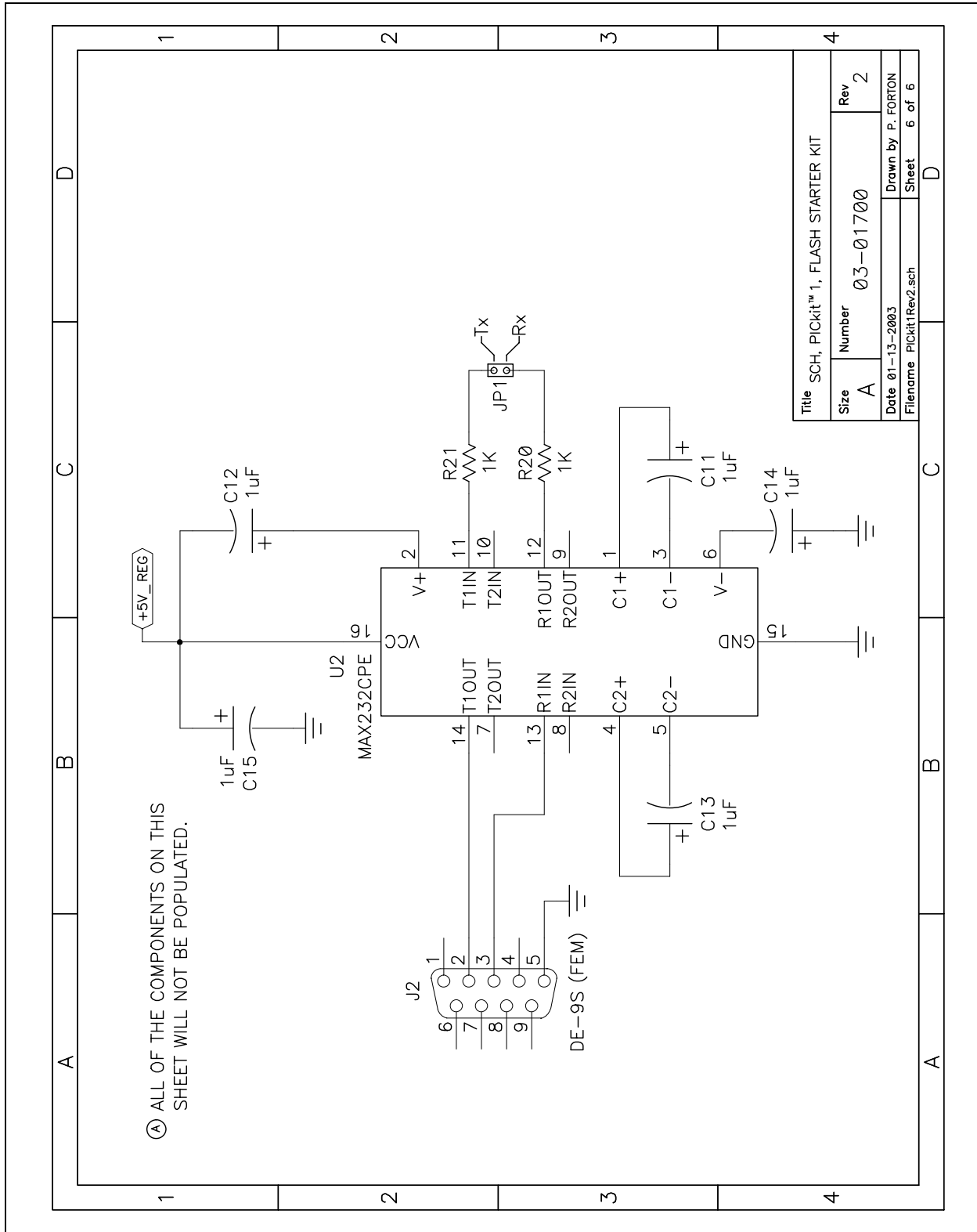

FIGURE A-5: PROTOTYPE 1



PICKit™ 1 Flash Starter Kit User's Guide

FIGURE A-6: PROTOTYPE 2



Appendix B. Baseline Flash Microcontroller Programming Schematic

B.1 SCHEMATIC DIAGRAM

FIGURE B-1: BASELINE FLASH MICROCONTROLLER PROGRAMMER SCHEMATIC

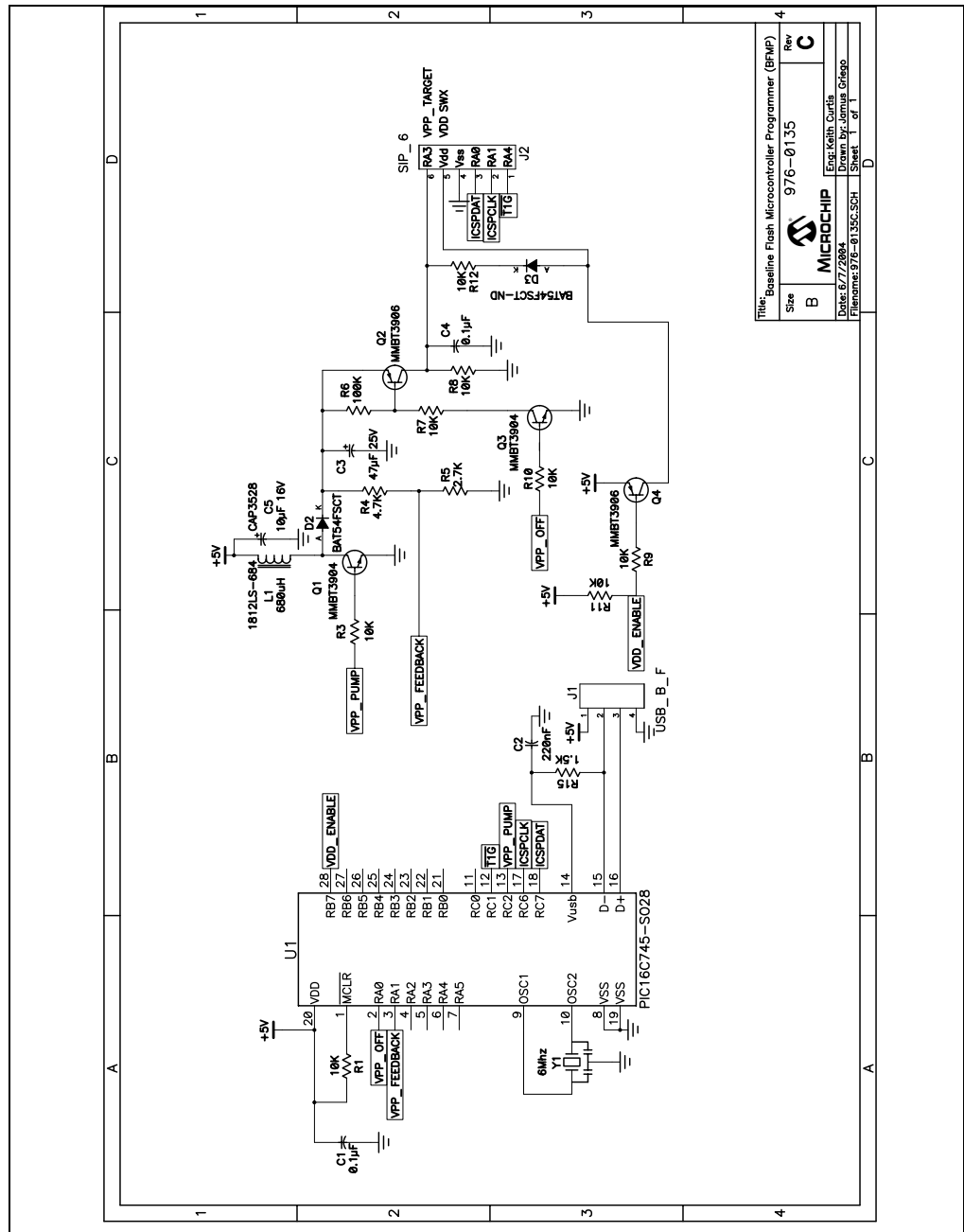

PICKit™ 1 FLASH Starter Kit User's Guide

NOTES:

Appendix C. PIC12F675 Programming Projects

C.1 INTRODUCTION

This appendix contains introductory lessons for users new to PICmicro® microcontroller units (MCU). The programming projects in this appendix describe different concepts in controlling the PIC12F675 PICmicro microcontroller unit (MCU). Each lesson includes instructions for running a program demo that illustrates each of the concepts listed below in Section C.2. It is best to follow the lessons in sequential order, for each lesson builds upon the previous one. (The hex files and source code for the lessons can be found on the PICKit™ 1 Flash Starter Kit CDROM.)

C.2 HIGHLIGHTS

The following lessons are discussed in this chapter:

Lesson 1 – Switch Debouncing

Lesson 2 – State Machines

Lesson 3 – Interrupts

Lesson 4 – Analog-to-Digital Converters and Comparators

Lesson 5 – Data Tables in Program Memory

Lesson 6 – Using EEPROM Memory

Lesson 7 – Frequency Counting with Timer1 Gate

C.3 LESSON 1 – SWITCH DEBOUNCING

Mechanical switches play an important and extensive role in practically every computer, microprocessor and microcontroller application. Mechanical switches are inexpensive, simple and reliable. In addition, switches can be very noisy. The apparent noise is caused by the closing and opening action that seldom results in a clean electrical transition. The connection makes and breaks several, perhaps even hundreds, of times before the final switch state settles.

The problem is known as switch bounce. Some of the intermittent activity is due to the switch contacts actually bouncing off each other. Imagine slapping two billiard balls together. The hard non-resilient material doesn't absorb the kinetic energy of motion. Instead, the energy dissipates over time and friction in the bouncing action against the forces push the billiard balls together. Hard metal switch contacts react in much the same way. Also, switch contacts are not perfectly smooth. As the contacts move against each other, the imperfections and impurities on the surfaces cause the electrical connection to be interrupted. The result is switch bounce.

The consequences of uncorrected switch bounce can range from being just annoying to catastrophic. For example, imagine advancing the TV channel, but instead of getting the next channel, the selection skips one or two. This is a situation a designer should strive to avoid.

PICKit™ 1 Flash Starter Kit User's Guide

Switch bounce has been a problem even before the earliest computers. The classic solution involved filtering, such as through a resistor-capacitor circuit, or through re-settable shift registers (see Figure C-1 and Figure C-2). These methods are still effective, but they involve additional cost in material, installation and board real estate. Why suffer the additional expense when software is free and program memory is abundant.

FIGURE C-1: FILTERING DEBOUNCE SOLUTION

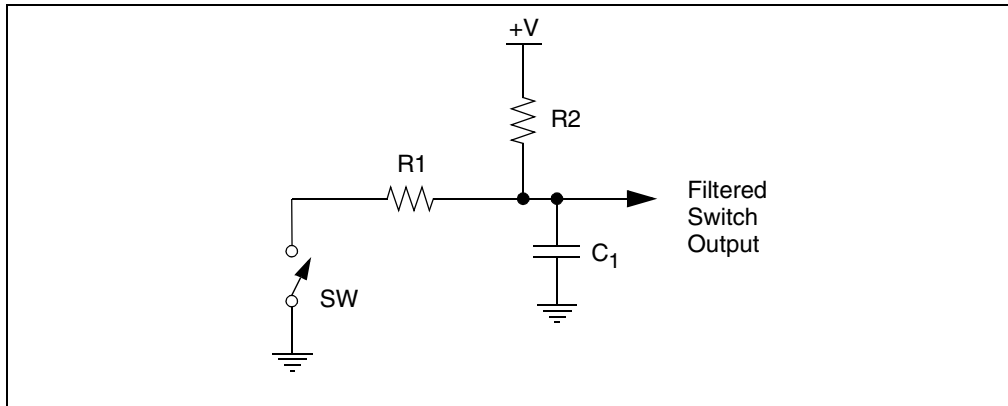
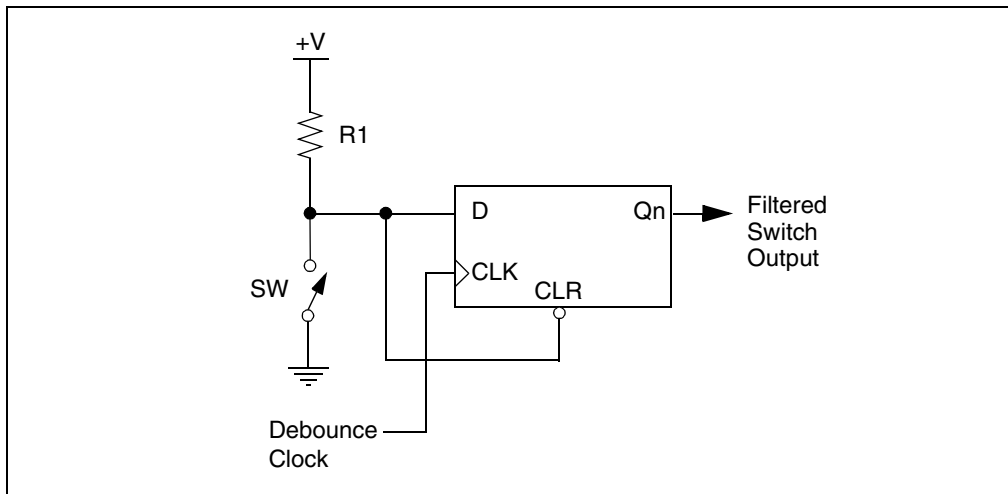

FIGURE C-2: SHIFT REGISTER DEBOUNCE SOLUTION



C.3.1 Design

Switch bounce is intermittent contact and release of the switch contacts. Two parameters characterize switch bounce: bounce period and bounce duration.

Bounce period is the random length of time the contacts remain open, or closed, while the bounce is occurring. Bounce periods can vary anywhere from a few nanoseconds to a few milliseconds.

Bounce duration is the time from the leading edge of the first bounce period to the trailing edge of the last bounce period. The difficulty is bounce duration is indeterminate.

Bounce abatement design starts by making assumptions based on empirical data. The first assumption is bounce period will be absolutely less than 10 milliseconds. Experience dictates this is a good assumption, however, bench and field-testing are still essential to ensure the switch selected for the application does not have a longer bounce period. The second assumption is the total bounce duration is indeterminate. A good design should work regardless of how long the switch bounces provided that it eventually does stop bouncing.

C.3.1.1 BRUTE FORCE DEBOUNCE

Consider a simple push button application. In this case, some event should occur when a button is pushed. Ideally the invoked event will occur immediately, and only once for each button push. The system should also be ready to respond to a repeat button push as soon as possible after the button is released. This presents an apparent dilemma. How is the difference between switch bounce and repeated button pushes determined?

Recall the assumption that the bounce period is less than 10 milliseconds. If the switch input level is stable for longer than 10 milliseconds, then bouncing has stopped and the input level represents the pushed or released switch state. The Brute Force method only cares about a button-push event because this is what invokes the action. It recognizes the switch release state as the stable state and everything else is considered unstable. When the switch becomes unstable, the action is invoked permitting nothing to happen until the switch returns to the released stable state.

The flowchart in Figure C-3 outlines the software actions necessary to implement the Brute Force debounce method. Notice that the debounce loop is looking for a stable released state for 10 milliseconds before returning to the top of the main loop. Any instability, including a stable button pushed state, resets the debounce 10 millisecond timer.

FIGURE C-3: BRUTE FORCE SWITCH DEBOUNCE

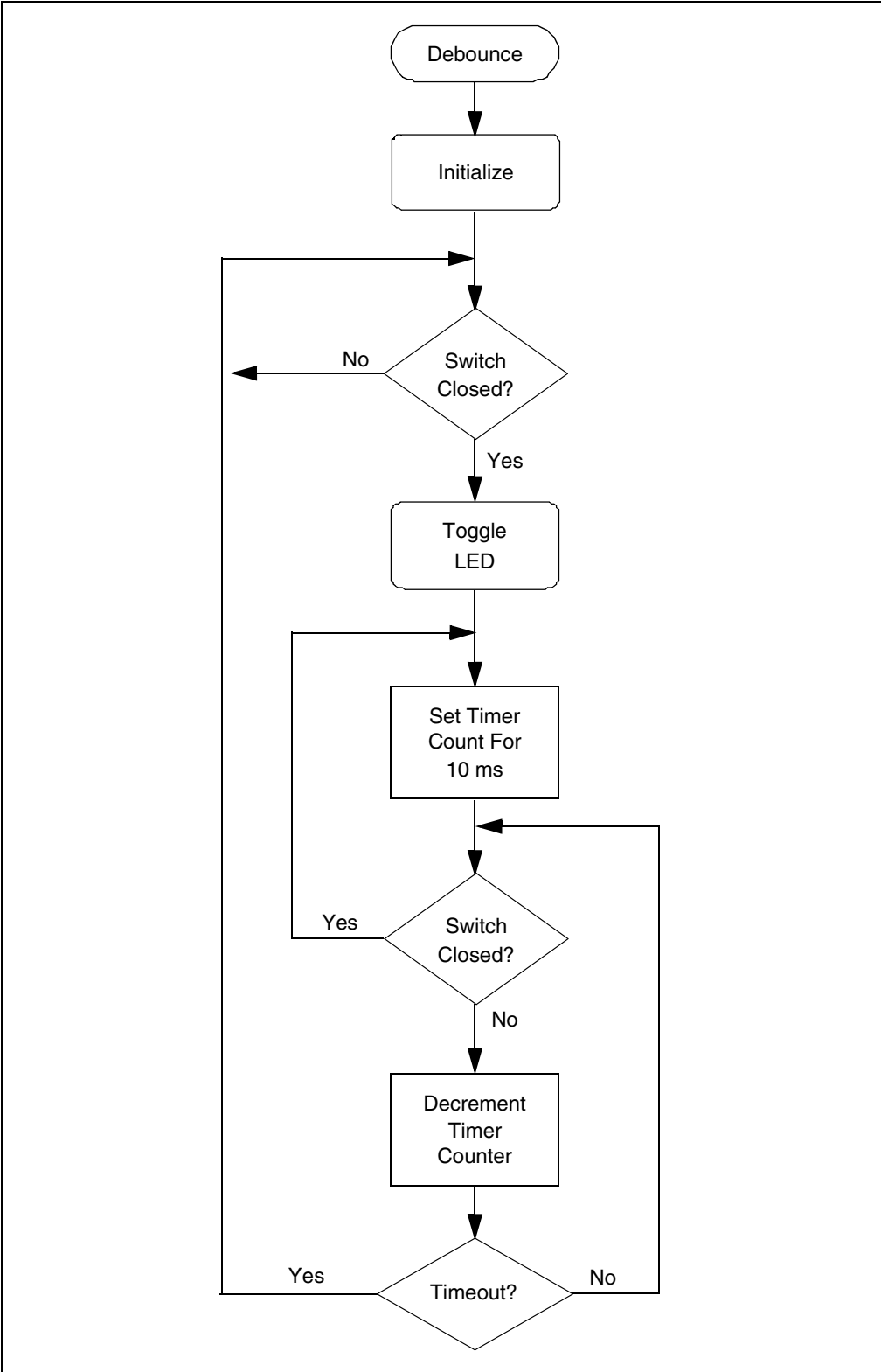

C.3.1.2 SWITCH FILTER DEBOUNCE

There are situations when both stable switch states must be recognized. It is undesirable for immediate action to occur if the switch intermittently leaves either the pushed or released state. A door open or closed sensor switch is a good example of this. If the door is closed and gets bumped, then the door-open action, such as an alarm, should not occur because the door is still closed.

The Switch Filter Debounce method delays the response to a changed switch state. Delay time can even be extended to several times the bounce period. Switch Filter Debounce incorporates a saturating up/down counter. (A saturating counter is one that stops counting when the maximum, or minimum, number is reached.) The counter counts up when the switch is closed, and counts down when the switch is open. The appropriate action is invoked when the counter reaches either the full up or down count.

Hysteresis is built into the count length. Switch release or contact action is invoked only upon the first occurrence of counter saturation. The counter must saturate at the opposite state before the previous state can be re-invoked. During switch bounce, the counter intermittently counts up and down. The counter will progress up when the average closed to open period favors contact, and down when the average period favors release. The faster the switch settles in the closed or open state, the faster the counter will reach the corresponding saturated condition.

Switch Filtering assumes, when the switch is mostly closed or open, the bouncing will favor the closed or open levels respectively. It is possible for the counter to saturate before the switch has stopped bouncing. It is unlikely that the counter will change saturation state unless the count is too short, or the switch is headed in that direction.

Figure C-4 outlines the software actions necessary to implement the Switch Filtering Debounce method.

FIGURE C-4: TIME AVERAGED SWITCH FILTER DEBOUNCE

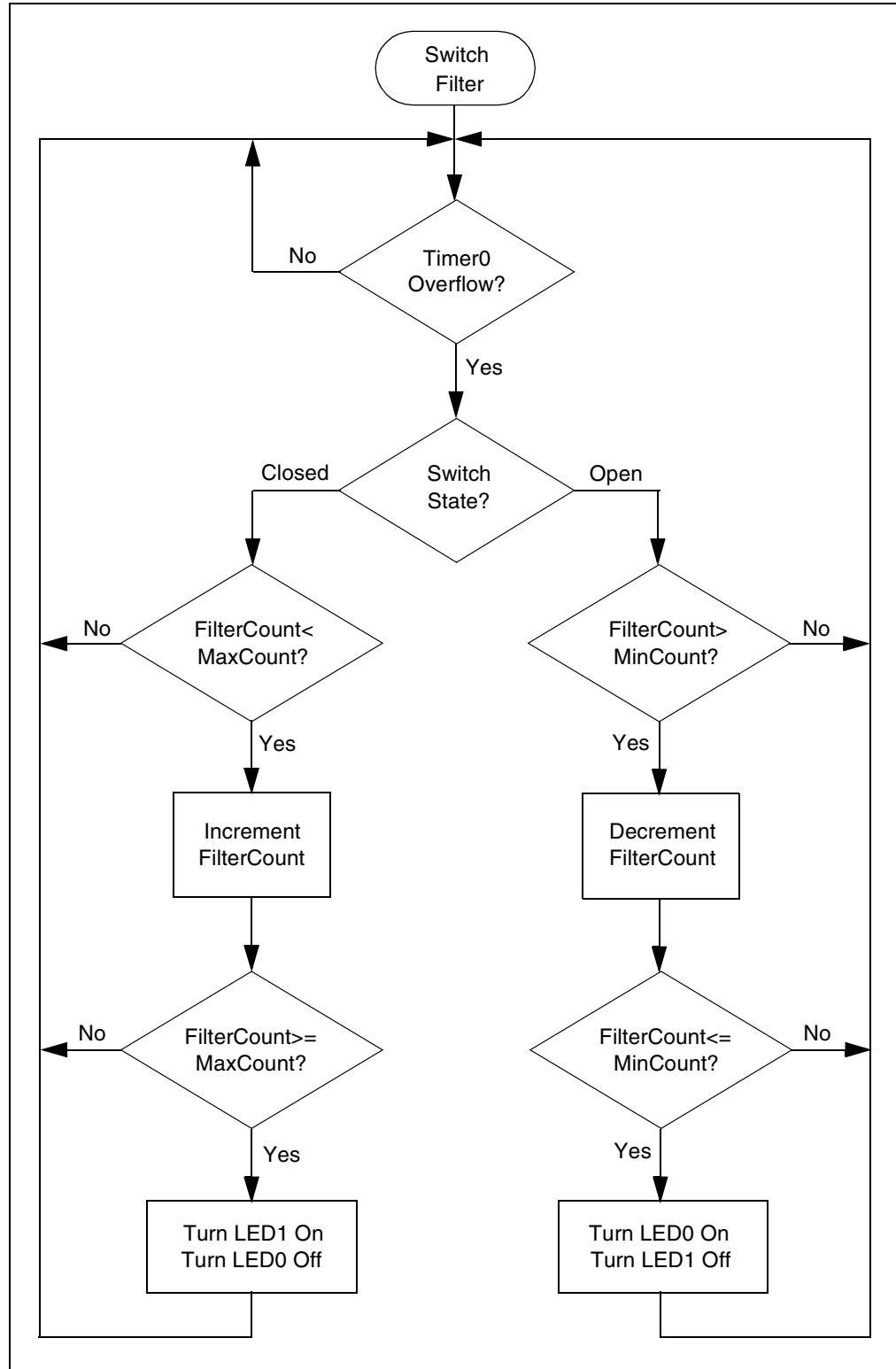

C.3.2 Applications

Reliable, robust software requires debouncing of all mechanical switches. This includes push buttons of all types, limit switches of all types and even X*Y matrix keyboards. Matrix keyboards offer a new challenge to debouncing. Keyboards are not a single line input level but a pattern on several inputs. One pattern represents all keys released, or the stable state. All other patterns represent keys pressed, or the unstable states. Reliable keyboards can be designed by debouncing to only the stable state, but allowing new actions to occur immediately upon a change from one unstable state to another. The solution is left to the interested student.

C.3.3 Running the Demos

There are three switch debounce demos: Debounce, SwchFltr and DbncFltr. The file name suffix denotes the source code language for each demo. The suffix “.asm” denotes assembly language. The suffix “.c” denotes C language. Use the Intel 32-bit hex file output as the input file to the PICKit 1 Flash Starter Kit demo board. Intel hex files are denoted by the “.hex” file suffix.

C.3.3.1 DEBOUNCE DEMO

Debounce is the Brute Force Debounce demo. Each button push in this demo causes LED D0 to toggle on or off.

Perform the following steps to run the Debounce demo:

1. Connect the USB cable to the USB PC port and to the PICKit 1 Flash Starter Kit demo board.
2. Execute the PICKit 1 Flash Starter Kit programming software.
3. From the toolbar menu, select *File -> Import Hex*. Browse to locate the hex file named “Debounce.hex”. Select this file and click the **Open** button.

Note: The Program Memory window displays the program code.

4. Click the **Write Device** button. The status of the program write is displayed in the status bar located at the bottom of the interface window.
5. To run the demo, push the **SW1** switch on the board and observe that LED D0 toggles as expected.

C.3.3.2 SwchFltr DEMO

SwchFltr is an abbreviation for the Switch Filter Debounce demo. In this demo, LED D1 lights up when SW1 is pushed. When SW1 is released, LED D0 lights up.

Repeat steps 1 through 5 above and load the SwchFltr.hex file to run this demo.

C.3.3.3 DbncFltr DEMO

DbncFltr is an abbreviation for Debounce Filter. This demo is a combination of the Debounce and Switch Filter demos. DbncFltr also demonstrates timed expansion of switch functions. This demo initializes in the Switch Filter mode. Holding the button down for more than 1 second, while in the Switch Filter mode, causes the demo to change to the Brute Force method. LED D0 will light as an indication of the change. Holding the button down for more than 1 second, while in the Brute Force mode, causes the demo to change to the Switch Filter method. LED D1 will light as an indication of the change.

Repeat steps 1 through 5 above and load the DbncFltr.hex file to run this demo.

C.4 LESSON 2 – INTRODUCTION TO STATE MACHINES

State Machines are an integral part of software programming. State machines make code more efficient, easier to debug and help organize the program flow. State machines are not limited to just firmware, they can be used to streamline any system. However, this document limits the scope of state machines to microcontroller firmware.

C.4.1 Design

C.4.1.1 WHAT IS A STATE MACHINE

A Finite State Machine (FSM) is based on the idea of there being finite number of states for a given system. For instance, when an application turns an LED on and off, two states exist; one state is when the LED is on and the other is when it is off. The example firmware that this document refers to turns on eight LEDs sequentially. Only one LED is on at a time, therefore eight states exist. Each state consists of one LED being turned on while all the rest are off.

State machines require a State Variable (SV). The SV is essentially a pointer that keeps track of the state that the microcontroller is in, and directs the program flow to the corresponding software module. The SV can be modified in the software modules (or states) themselves or by an outside function. The example firmware uses an outside function which detects a button press to advance through the states.

C.4.1.2 BENEFITS OF STATE MACHINES

The introduction briefly mentioned some advantages of state machines. These advantages are worth studying in greater detail because they are what make programming with state machines so rewarding and beneficial to firmware developers.

The first advantage is using state machines inherently promotes good firmware design techniques. When beginning to implement an application, think about what states are necessary to make the application work. List all the pieces, or states, of an application and then explore how they tie to one another. This will help prevent developing bugs in the code. This line of thinking also leads to the development of a very useful engineering tool – the flow chart. The following paragraph covers state machine development in greater detail.

State machines have one characteristic that cause them to be very beneficial. They always return to one spot (or jump station) in the code at which the program flow is channeled, by the state variable, to the corresponding software module. This provides several advantages. First, this characteristic makes calling repetitive tasks on a regular basis quite simple. Clearing the watchdog timer, checking for I/O button presses or communicating with a host that requires periodic communication are examples of repetitive tasks. The alternative to using state machines is to use looping code. In order for looping code to handle repetitive tasks, the functions that handle these tasks must be distributed throughout the code in each of the loops. This is not only highly inefficient but also confusing to understand. Figure C-5 shows a block diagram of what the example code would look like if a state machine were not used. Compared to Figure C-6, which shows a block diagram of state machine based code, it is clear that using a state machine cuts down on code space and the likelihood of missing a repetitive task call.

FIGURE C-5: STATE MACHINE NOT USED

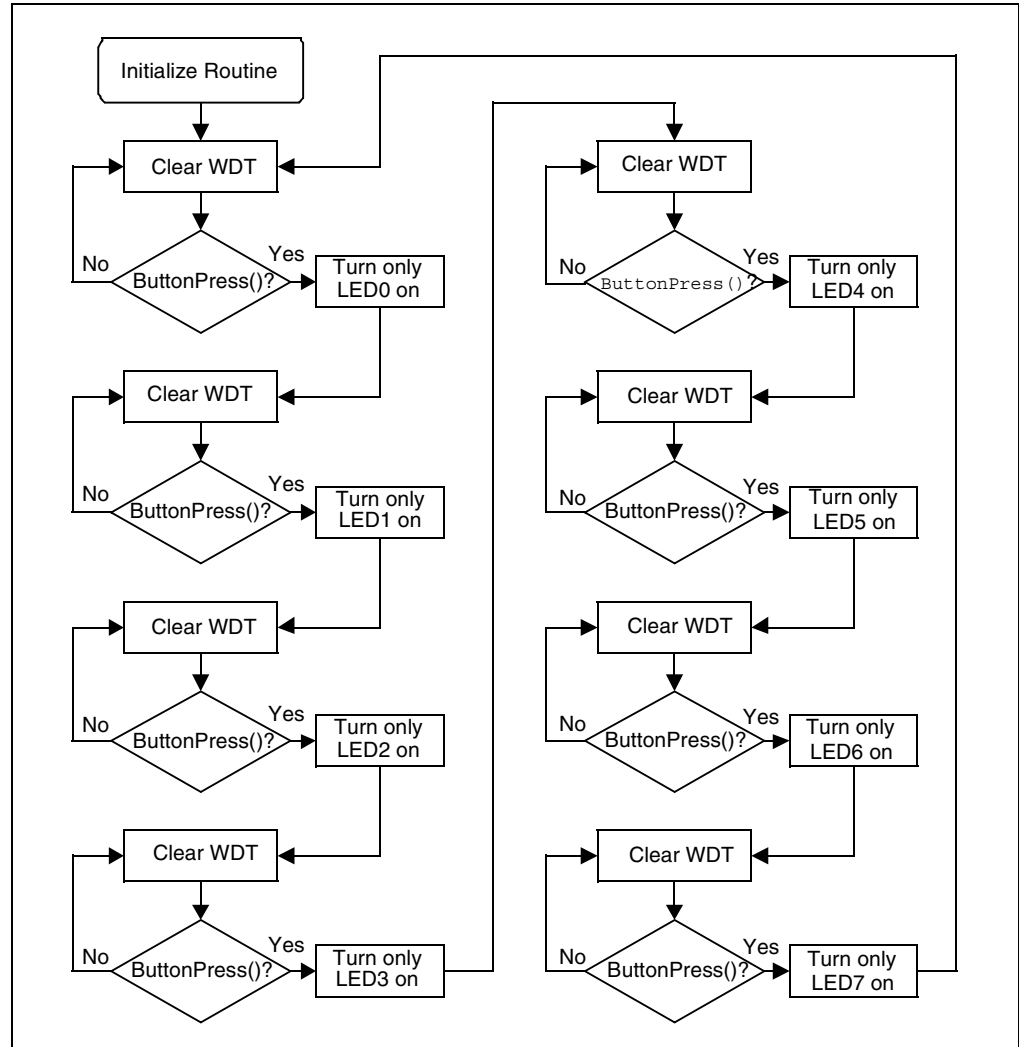
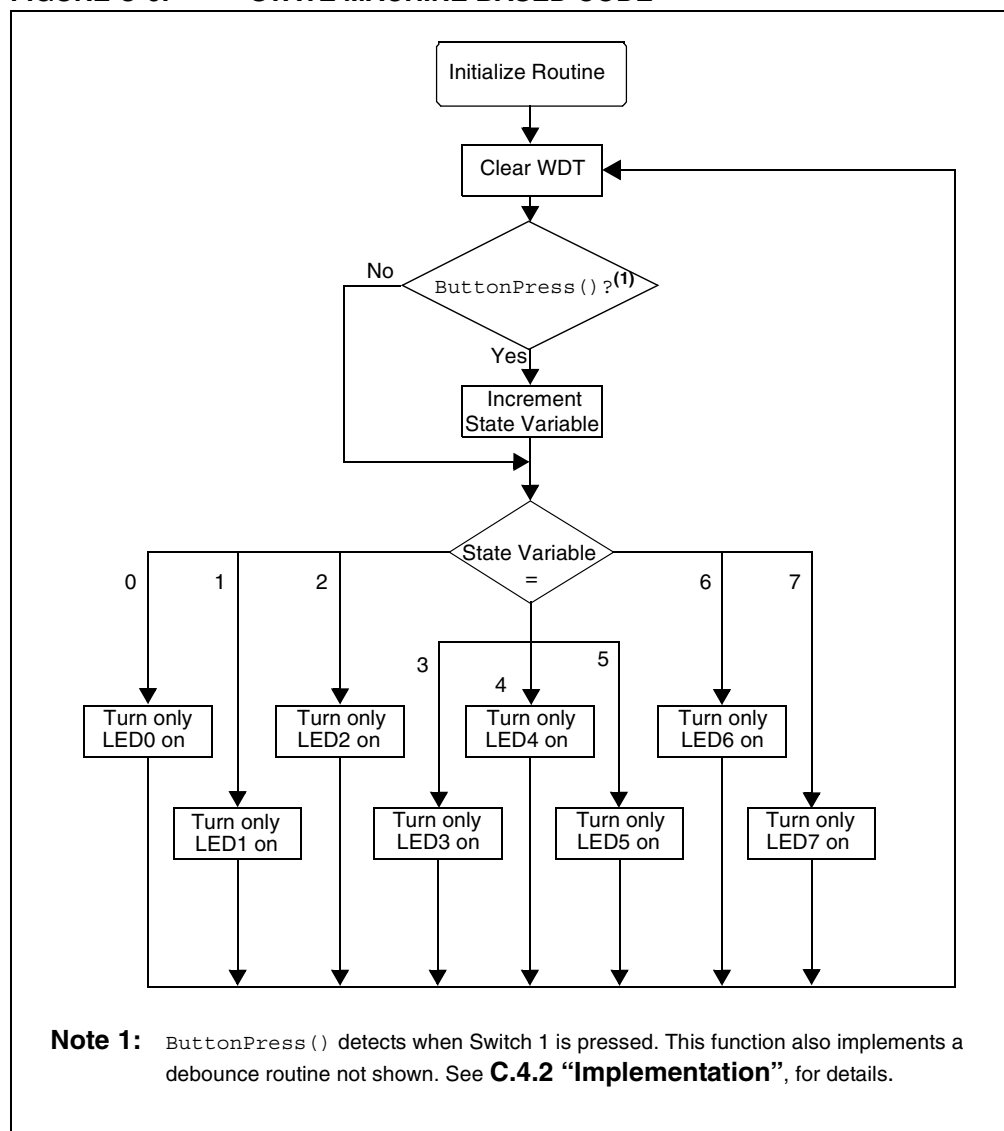

FIGURE C-6: STATE MACHINE BASED CODE



The fact that the state machine based firmware always returns to the same point in the code also makes the firmware easier to debug. When a bug is encountered, set a break point at the jump station. Then, step through the program state by state until the bug is found. An example of a bug would be the SV being modified incorrectly in one of the states. If this happens, the wrong state will be called the next time the program flow returns to the jump station. However, because the SV is being monitored, it will be very easy to see when an unintentional change is made to the SV and in which state the SV was incorrectly modified.

Note: MPLAB IDE contains a built-in simulator. See the *MPLAB IDE v6.xx Quick Start Guide* available on the MPLAB IDE CD-ROM included with the PICkit 1 Flash Starter Kit

Another benefit of state machines is that it naturally promotes modular code. Modular code has its own list of benefits:

1. Upgrades and special features can be easily added to the code in later revisions or as a product evolves.
2. Modules can be cut and pasted into other applications quickly and easily.
3. Other developers will be able to understand the code in order to support it. The jump station, if commented well, can be an index to each of the software modules.

C.4.2 Implementation

C.4.2.1 GENERAL THOUGHT PROCESS

When implementing a FSM, first brainstorm all the states needed to complete a particular application. Once this is done, identify the first state. Next, the following question should be answered: "What needs to happen to exit this state, and what state will it exit to?" Usually there is more than one answer to this question. Depending on what happens while in a particular state, the state machine may advance a state, decrement a state or skip several states entirely. As mentioned before, it is generally a good idea to visually construct the state machine in the form of a flowchart. Finally, create a software module for each of the states and tie them together according to the flowchart just created.

C.4.2.2 TRANSLATING STATE MACHINES INTO ASSEMBLY AND C

Implementing a state machine in C is quite simple to visualize. C based state machines rely on the “switch” statement. The following example code shows a “switch” statement being used as a state machine.

EXAMPLE C-1: SWITCH STATEMENT

```
switch (STATE) {
    case (State0):
        // turn LED0 on
        break;
    case (State1):
        // turn LED1 on
        break;
    case (State2);
        // turn LED2 on
        break;
    ... and so on
    default:
        STATE = State0 // if for some reason a undefined
                       state occurs,
                       // re-initialize the state machine
}
```

Creating a state machine in assembly is a little more difficult. In assembly, the program flow is directed to the appropriate software module for a given state by incrementing the Program Counter by the state variable. Incrementing the Program Counter is comprised of incrementing PCL and PCLATH (when PCL overflows.) If a provision of increment PCLATH is not included, then there is a risk of jumping to the wrong spot in the program if PCL overflows. Immediately following the increment routine is a list of “goto” statements that direct the program flow to one of the states. This method is called a “computed goto”. The following example code shows how to use a computed goto for a state machine.

EXAMPLE C-2: COMPUTED GOTO

```
Initialize
  clrf      STATE          ;initialize state machine
  . . .

Main
  call     StateMachine
  . . .
  goto    Main

StateMachine
  movlw   high StateTable ;set high order byte of program
  movwf   PCLATH          ; counter appropriately
  movf    STATE, W        ;mask state variable to keep
  andlw   03h             ; things under control
  addlw   low StateTable  ;add state variable to ROM address
  btfsc   STATUS C        ; beginning State Table
  incf    PCLATH, F       ;overflows? yes, increment PCLATH
  movwf   PCL             ;move computed goto value into PC

StateTable
  goto    State0
  goto    State1
  goto    State2
  goto    State3

State0
  . . .
  incf    STATE, F        ;goto the next state
  return

State1
  . . .
  return
```

C.4.3 Implementing this Demo

The flowchart for this demo is shown in Figure C-6, however, the flowchart does not show the debounce routine implemented in `ButtonPress()`. The debounce routine is based on the Brute Force Debounce (described in Lesson 1, Section C.3) with one slight modification, the debounce routine is implemented as a state machine. The Debounce state machine differs from the LED state machine where the states themselves modify the state variable. Implementing the debounce routine as a state machine is easier to understand than implementing it as looping code.

C.4.3.1 APPLICATIONS

As mentioned earlier in Section C.4.1.2, state machines are useful in nearly every application. The LED library, in subsequent lessons, utilizes state machines to light the LED similarly to the state machine implemented in this lesson. State machines are useful for bit banging any number of communication protocols, receiving RF transmissions, controlling the speed of a motor – the list goes on and on. Understanding the states necessary to make the application work is a good way to begin implementing an application.

C.4.3.2 RUNNING THE DEMO

1. Program the state.hex code into the PIC12F629 PIC® microcontroller using the PICkit 1 Flash Starter Kit board and programming interface.
2. If the part is programmed successfully, the D0 LED will light up. Press the SW1 switch, located on the board, to sequence through the state machine. The D1 LED will light up, then the D2 and so on.

C.4.3.3 FILES REQUIRED FOR PROGRAM MODIFICATION

Assembly

- state.asm

HI-TECH C

- state.c
- state.h

C.5 LESSON 3 – INTERRUPTS

This program demonstrates how to use the Timer0 and pin change interrupts onboard the PIC12F6XX. In addition, the program illustrates how the PIC12F6XX is multiplexing the LED's fast enough to give the visual representation that the LED's are all on at the same time when in fact the LED's are lit individually. Finally, this program uses the interrupt on-pin change to detect and debounce a button push which changes the rate at which the LEDs are flashed.

This lesson covers the following topics:

- How to flash LEDs on the PICkit 1 Flash Starter Kit board
- How to use Timer0 and pin change interrupts on the PIC12F6XX
- How to turn a source code file into a library file for easy reuse
- Useful applications that can use the concepts presented in this lesson
- Files needed to customize the source code for the application

C.5.1 Design

One of the challenges of using an 8-pin PIC microcontroller is having enough pins for a robust application. The PICkit 1 Flash Starter Kit utilizes design tips and tricks to get the most out of the 8/14-pin PIC microcontroller devices. In particular, a 12-LED array is implemented on the PICkit 1 Flash Starter Kit by using only 4 pins. In this lesson, only 8 LED's are implemented. See Table C-1 for LED multiplexing. Also, see “TIP #2 Input/Output Multiplexing”, in the “Microchip Tips 'n Tricks 8-pin Flash PIC® Microcontroller” booklet (DS44040) for more details on LED multiplexing.

TABLE C-1: LED MULTIPLEXING TRUTH TABLE

PIN	D0	D1	D2	D3	D4	D5	D6	D7	D8	D9	D10	D11
GP4	HI	LOW	HI	LOW	Z	Z	Z	Z	Z	Z	HI	LOW
GP5	LOW	HI	Z	Z	HI	LOW	Z	Z	HI	LOW	Z	Z
GP2	Z	Z	LOW	HI	LOW	HI	HI	LOW	Z	Z	Z	Z
GP1	Z	Z	Z	Z	Z	Z	LOW	HI	LOW	HI	LOW	HI

Legend: HI => Logic 1, LOW => Logic 0 and Z => TRISIO = 1

C.5.2 Implementation

The lesson utilizes interrupts to make the LED operation transparent to the main program. The main program writes the value 0xFF to the LEDREGISTER. This flashes 8 LEDs on the PICkit 1 Flash Starter Kit board. In order to flash 4 LEDs, for example, write 0x0F into the LEDREGISTER. The interrupt service routine uses a Timer0 interrupt for updating the LED array. A GP3 pin change interrupt detects a button push. The Timer0 prescaler is adjusted and changes the amount of time it takes for a Timer0 interrupt to happen. This gives the visual representation that the LEDs are all on at the same time, or sequencing.

This lesson introduces the intlib library. The intlib library contains the core functions for flashing the LEDs and debouncing the GP3 push button. The intlib library contains the functions Display and Debounce. The library also contains the general purpose register, LEDREGISTER, to flash LEDs. See Section C.9.5, “Modifying the Source Code”, for more information on the required files needed to build this project in MPLAB IDE. Also, see the source code files for additional comments on the implementation. For a high-level flowchart, see Figure C-10.

C.5.3 Applications

This program is useful in the following applications:

1. Displaying an 8-bit value onto the LED array. See Lesson 4 on using the Analog-to-Digital Converter for reading an analog potentiometer and displaying its value on the LED array.
2. Detecting a button push immediately.
3. Flashing LED Patterns – See Lesson 5 and Lesson 6 for displaying different LED patterns stored in data tables.

C.5.4 Running The Demo

1. Program the ledint.hex code to the PIC12F6XX.
2. After the hex file is programmed to the device, the LED array displays all 8 LED's that appear to be on. To change the rate at which the LED's are flashed, push the SW1 button.

C.5.5 Modifying The Source Code

C.5.5.1 FILES REQUIRED FOR PROGRAM MODIFICATION

Assembly Source Code

- ledint.asm – Main file that contains the main program and interrupt routine
- ledint.h – Header file that defines the external program variables and routines
- intlib675.o or intlib629.o – Library file that contains the Display and Debounce routines for the PIC12F675 or PIC12F629 respectively
- 12f629.lkr or 12f675.lkr – Linker Script for PIC12F629 and PIC12F675 respectively
(Linker Script located in C:\Program Files\MPLAB IDE\MCHIP_TOOLS)

FIGURE C-7: MPLAB PROJECT SETUP – ASSEMBLY

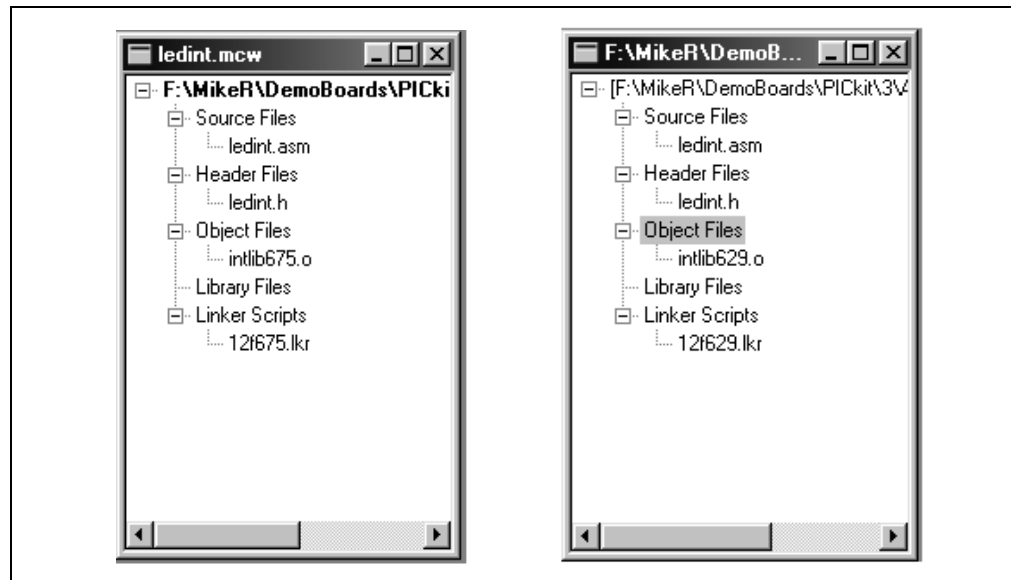

C Source Code

- ledint.c – Main file that contains the main program and interrupt routine
- ledint.h – Header file
- intlib675.obj or intlib629.obj – Library file that contains the Display and Debounce functions for the PIC12F675 or PIC12F629 respectively

FIGURE C-8: MPLAB PROJECT SETUP – C

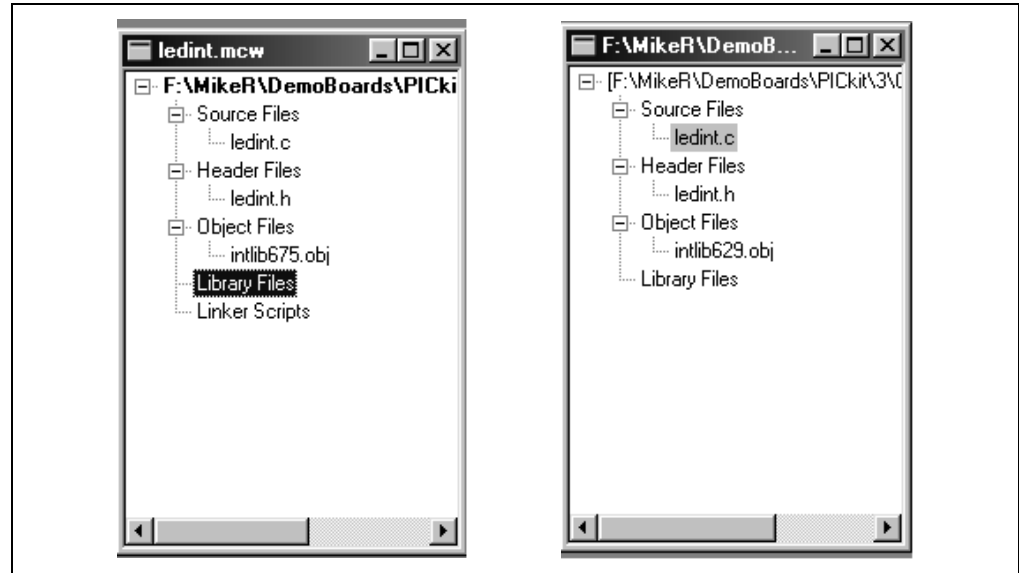

C.5.5.2 FILES REQUIRED FOR LIBRARY MODIFICATION

Assembly Source Code

- intlib.asm – Contains core Display and Debounce routines
(When assembled, a intlib.o file will be created)

C Source Code

- intlib.c – Contains core Display and Debounce routines
(When compiled, a intlib.obj file will be created)
- intlib.h – Header file

PICKit™ 1 Flash Starter Kit User's Guide

FIGURE C-9: MPLAB PROJECT SETUP – LIBRARY MODIFICATIONS

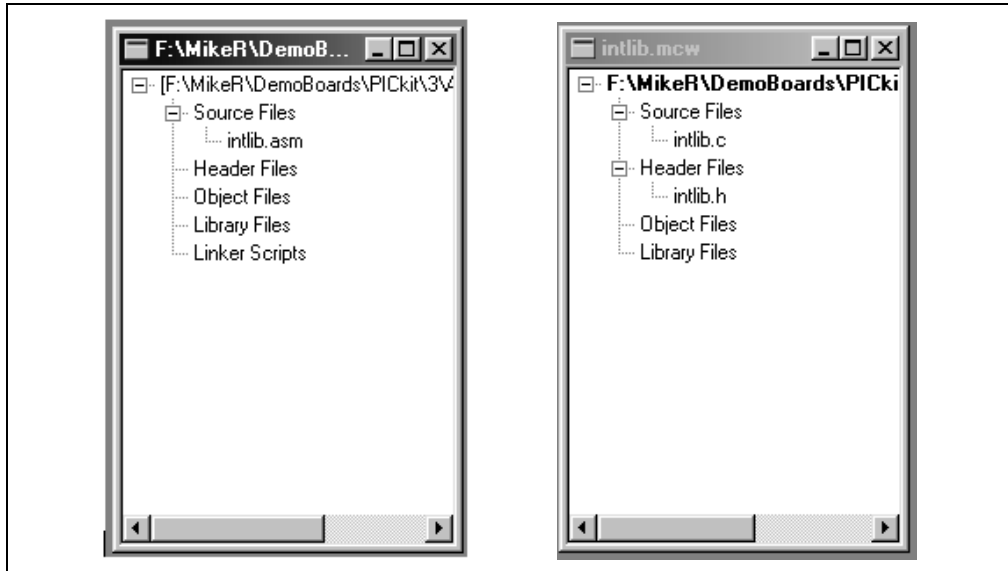
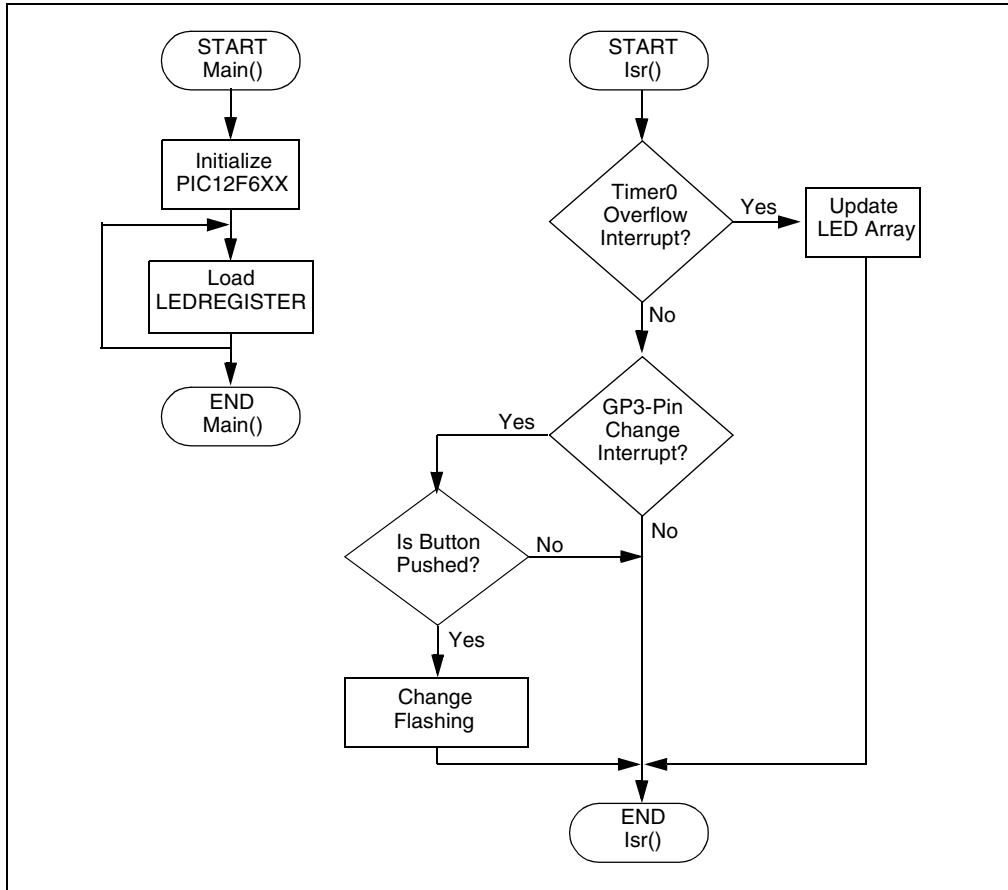

FIGURE C-10: HIGH LEVEL FLOWCHART



C.6 LESSON 4 – ANALOG-TO-DIGITAL CONVERTERS AND COMPARATORS

This lesson is broken up into two programs which demonstrate how to use the analog-to-digital converter, the comparator and the internal voltage reference. The first program set is comp.asm (written in assembly) and comp.c (written in C). This program shows the very basic implementation of using the comparator with the internal voltage reference. The second program set is atod.asm (written in assembly) and atod.c (written in C). This program uses the LED display library to show the value of the analog-to-digital (A-D) converter.

C.6.1 Comparator Lesson

For this lesson, the comparator is configured as a dedicated comparator driving the GP2 pin directly. With $\langle CM2:CM0 \rangle = 101$, the comparator has multiplexed inputs. GP0/CIN+ is selected as the input to the V_{IN-} by setting $CIS = 1$, thus making the analog potentiometer the one input. The internal voltage reference is used as the other input to the comparator on V_{IN+} . The module compares the potentiometer voltage with the reference, and the logic is setup ($CINV = 1$) such that the output is high when the input voltage is higher than the reference. LED3 is driven directly by the comparator and is lit when the output of the module is high. To light D3, you must configure RA4 (GPIO4) and RA2 (GPIO2) as digital outputs via the TRIS register, RA4 is set low and RA2 is driven directly by the comparator without additional software overhead. The remaining I/O's are configured as high impedance inputs.

Note: The schematics, as shown in Appendix A, display the 14-pin device pinout. This is compatible with 8-pin devices.

The internal voltage reference is essentially a variable resistor based voltage divider between V_{DD} and V_{SS} . Use the low range mode ($VRR = 1$) and set the internal reference to be $0.5 V_{DD}$ by selecting $\langle VR3:VR0 \rangle = 1100$, thus $CV_{REF} = V_{DD} * (12/24)$. By stepping through the different voltage reference settings, a basic-low resolution analog-to-digital converter can be implemented.

The comparator module has seven different modes. Three of the modes can drive an output pin directly. The software can monitor the output directly or create an interrupt on change. Bits $CMIE$ and $PEIE$ must be set to enable the comparator interrupt which can be used to wake the device from SLEEP.

Figure C-11 shows the project setup for the assembly and C projects.

FIGURE C-11: ASSEMBLY AND C PROJECT SETUP

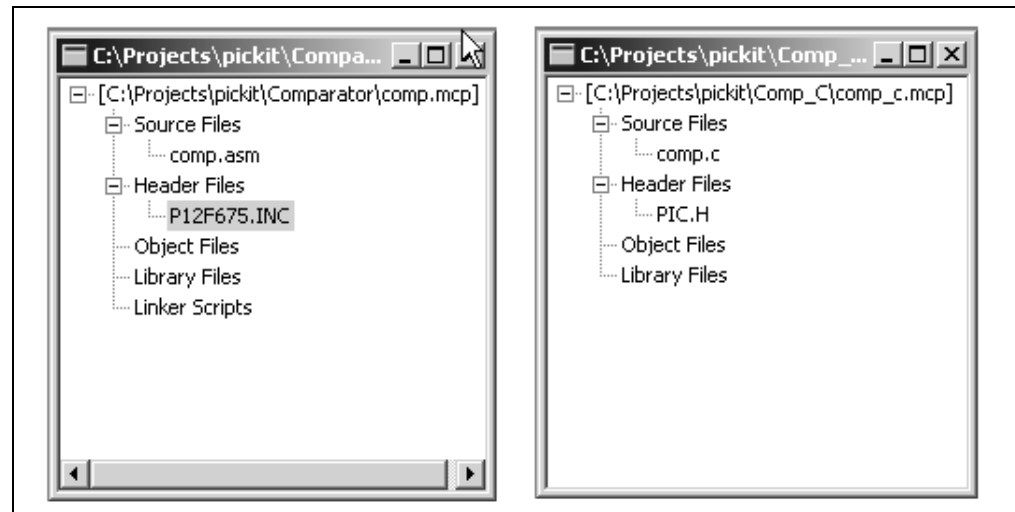

C.6.2 Analog-to-Digital Converter Lesson

This lesson uses the PIC12F675 and demonstrates an interrupt based analog-to-digital conversion. TMR0 is set up with a prescaler of 4, thus creating an interrupt roughly every 1 ms. With every TMR0 interrupt, either the LED display routine is serviced (see **Lesson 3**) or the A/D routine is serviced depending on the flag that toggles with every interrupt. Noise is generated on VDD when the LEDs are updated. Therefore, to reduce noise in the A/D process, either a new A/D conversion is done or the display is updated, but not simultaneously. The A/D interrupt source is not used because the service interval (2 ms) is much longer than the conversion period of 22 μ s. The A/D module requires at least 4 μ s for the sample capacitor to charge between acquisitions, but the program allows for about 2 ms. The result of the A/D is 10 bits, even though only the eight most significant bits are displayed on the LEDs. The result is left justified (ADFM = 0) and the most significant byte is written to the LEDREGISTER to be displayed. The ANSEL register specifies which of the general purpose I/O pins are to be configured as analog inputs to the A/D module. In this case, the potentiometer's output serves as the input to AN0.

Figure C-12 shows the source code files for the assembly and C projects respectively.

FIGURE C-12: ASSEMBLY AND C SOURCE CODE FILES

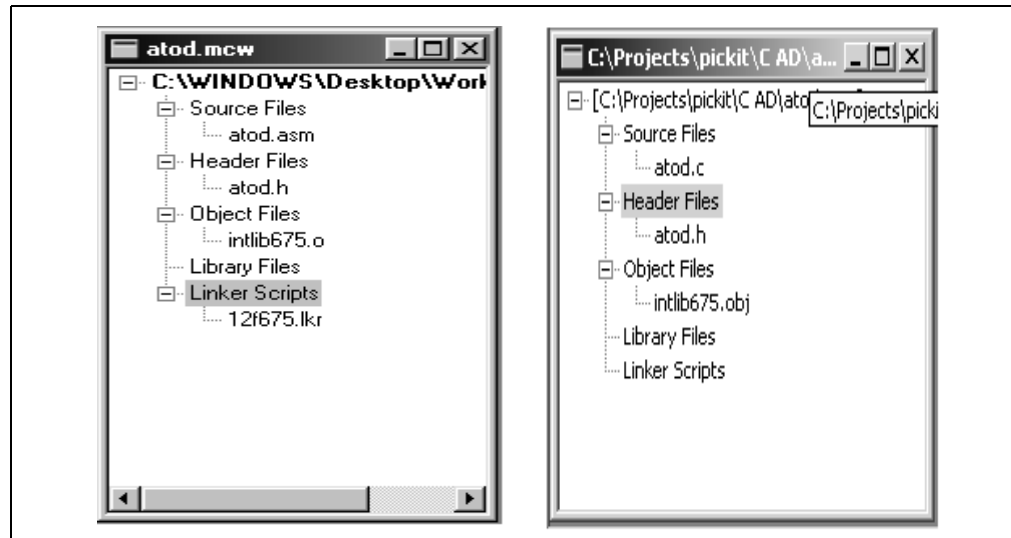
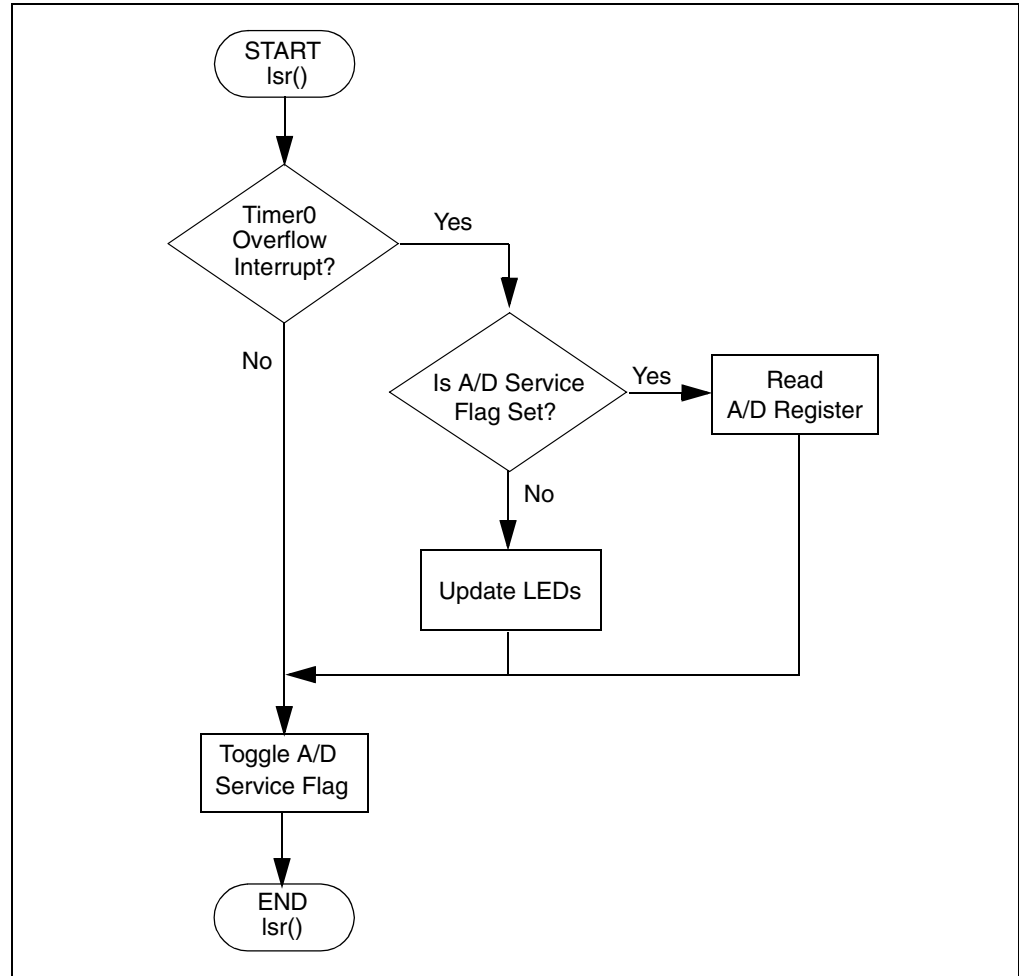

FIGURE C-13: ANALOG-TO-DIGITAL CONVERSION



C.7 LESSON 5 – PROGRAM MEMORY LOOK-UP ROUTINES

There is often a need to store constants or strings in a PIC microcontroller. Storing this information in program memory is the best solution as long as this data never needs to change and program memory is available. Program memory is non-volatile, therefore, it will maintain information regardless of VDD voltage levels or PIC microcontroller reset. This lesson demonstrates how to retrieve data from Program Memory. It covers the following topics:

- What a program memory look-up table is
- How a program memory look-up table is implemented
- Why a program memory look-up table is useful

C.7.1 Design

Constants stored in program memory are accessed via look-up tables. A look-up table is similar to a computed `goto` (see **Lesson 2**) only instead of a list of `goto` statements, after incrementing the program counter, there is a list of `retlw` instructions. Each `retlw` instruction is followed by one byte of the information. Example C-3 shows a look-up table for the string “Microchip” written in assembly language.

EXAMPLE C-3: LOOK-UP TABLE WRITTEN IN ASSEMBLY

```
LookupProgramMemory
    movlw    high StartTable
    movwf   PCLATH
    movlw    low StartTable
    addwf   index, w
    btfsc   STATUS, C
    incf    PCLATH, f
    movwf   PCL
StartTable
    retlw   "M"
    retlw   "i"
    retlw   "c"
    retlw   "r"
    retlw   "o"
    retlw   "c"
    retlw   "h"
    retlw   "i"
    retlw   "p"
```

For this lesson, constants corresponding to a sequence of LEDs are stored in a program memory look-up table. For instance, the first constant stored is 5F. This corresponds to the binary number “01011111”. Each bit corresponds to an LED, therefore, LEDs D0, D1, D2, D3, D4 and D6 will be lit when this constant is accessed. After each look-up table, the value is displayed on the LEDs in the same fashion as discussed in **Lesson 3**, using the Timer0 interrupt. The appearance of more than one LED being lit at a time is possible because the LEDs are multiplexed fast enough that the human eye can not detect the LEDs being turned on and off. When SW1 is pressed, an interrupt-on-change is generated to increment the lookup to the next location. Figure C-14 shows the flowchart for this example.

FIGURE C-14: PROGRAM MEMORY LOOK-UP TABLE PROCESS

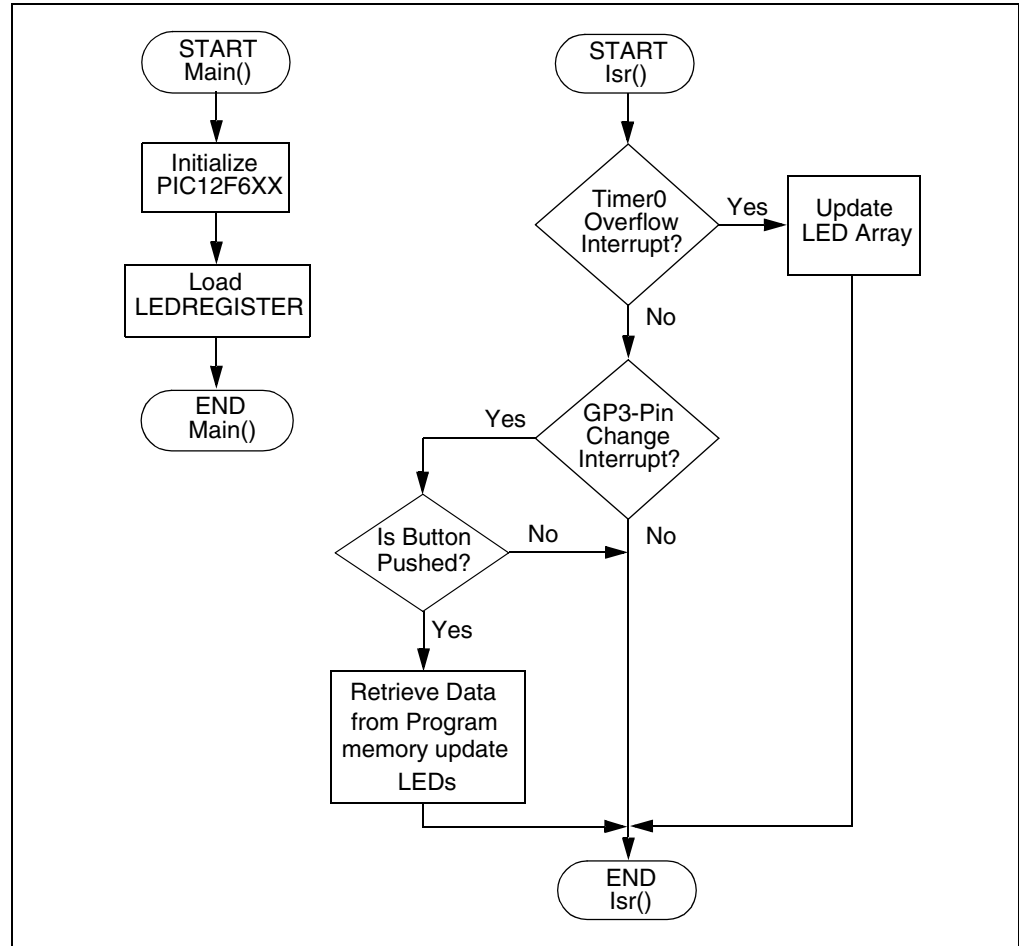

C.7.2 Applications

The lookup routines presented herein are useful in applications that require the following:

1. Retrieving calibration values.
2. Retrieving serial numbers.
3. Retrieving LED sequences.
4. Retrieving constants or strings in general that will not change over the lifetime of the PIC microcontroller.

C.7.3 Running The Demo

1. Program the pglookup.hex code to the PIC microcontroller.
2. After the hex file is programmed to the device, the LED array should show the first look-up value in the 8 LEDs. To increment to the next look-up value, press SW1. See Table C-2.

TABLE C-2: DATA TABLE

Instruction	Byte
retlw	0x5F
retlw	0x06
retlw	0x3B
retlw	0x2F
retlw	0x66
retlw	0x6D
retlw	0x7D
retlw	0x07

C.8 LESSON 6 – DATA EE LOOK-UP ROUTINES

C.8.1 Introduction

Lesson 5 discussed storing and retrieving constants from program memory. The benefit of storing information in non-volatile program memory is when power is cycled to the microcontroller, the information is not lost. However, the main disadvantage is information stored in program memory can not change. RAM, on the other hand, offers the versatility of change, but is volatile (it is cleared when power is cycled to the microcontroller.) Data EEPROM solves this problem by providing non-volatile readable/writable memory. An added benefit of data EEPROM is a developer can free up valuable RAM by using data memory to store rarely accessed variables. This lesson covers the following topics:

- How to implement data EEPROM look-up routines
- Why data EEPROM look-up routines are useful

C.8.2 Design

The PIC12F629/675 (DS41190) and PIC16F630/676 (DS40039) data sheets provide detailed instructions on how to access data memory. See the data sheets for timing specifications and limitations to the data memory. The data sheets are located on this CD and the Microchip web site (www.microchip.com).

The steps for reading the data EEPROM are as follows:

1. Write the data memory location to the EEADR register.
2. Set EEPROM control bit RD (EECON1<0>).

All data memory locations can be accessed using a single routine when an index variable is utilized. Example C-4 shows how to use an index variable to read the data memory.

EXAMPLE C-4: INDEX VARIABLE

```
LookupDEE
  movf    index,w          ; move data memory address pointer
  banksel EEADR           ; to EEADR
  movwf   EEADR
  bsf     EECON1,RD       ; read data
  movf   EEDATA,w         ; return with LED sequence in w
  return
```

As discussed in Lesson 5, the returned value corresponds to an LED sequence. This value is displayed using the Timer0 interrupt. The LEDs are multiplexed fast enough to appear as though more than one LED is on at the same time. When SW1 is pressed, an interrupt-on-change is generated and the next LED sequence is read from the data memory. Figure C-15 shows the flowchart for this lesson.

FIGURE C-15: DATA EE LOOK-UP ROUTINES

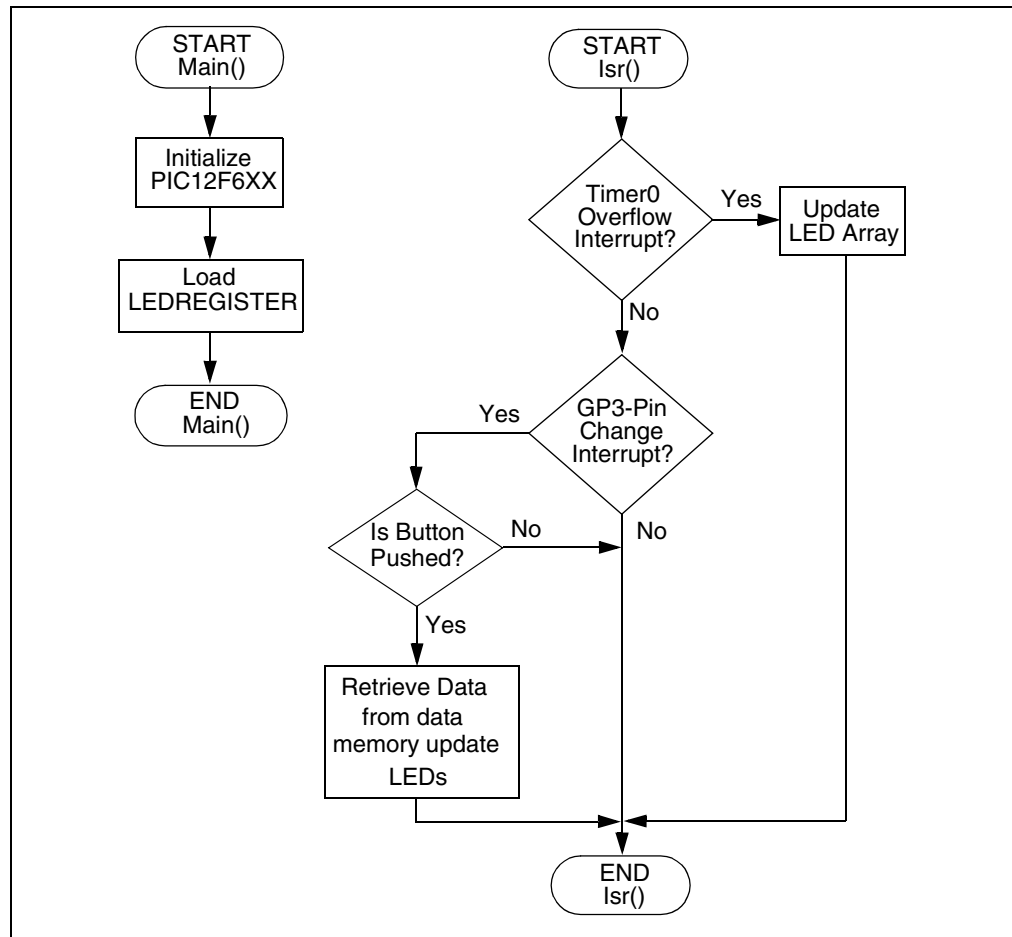

C.8.3 Applications

The look-up routines presented herein are useful in applications that require the following:

1. Storing and retrieving calibration values.
2. Maintaining current identification information.
3. Data logging information.
4. In general, for any applications that require non-volatile variable memory.

C.8.4 Running The Demo

1. Program the dtlookup.HEX file into the PIC microcontroller.
2. After the hex file is programmed into the device, the LED array should show the first look-up value in the 8 LEDs. To increment to the next look-up value, press SW1. See Table C-3.

TABLE C-3: DATA TABLE

Instruction	Byte
org	2100h
DE	0x5F
DE	0x06
DE	0x3B
DE	0x2F
DE	0x66
DE	0x6D
DE	0x7D
DE	0x07

C.9 LESSON 7 – FREQUENCY COUNTING WITH TIMER1 GATE

This program introduces the concept of auto-calibration of the PIC12F6XX internal RC oscillator using a known reference frequency. The PIC12F6XX has an internal RC oscillator capable of being calibrated to $\pm 1\%$.

This lesson covers the following:

- How to set up and use the Timer1 gate peripheral
- How to calibrate the PIC12F6XX internal RC oscillator
- Useful applications that use the concepts presented in this lesson
- Files needed to customize source code for the application

C.9.1 Design

This program takes advantage of the TIMER1 gate peripheral onboard the PIC12F6XX for auto-calibration of the PIC12F6XX device. A 2.5 kHz reference signal is connected to pin GP4/Timer1Gate input on the PIC12F6XX device.

The PIC12F6XX internal RC oscillator has the capability to run at 4 MHz $\pm 1\%$. Using Timer1Gate is advantageous because it can eliminate busy waiting on the PIC microcontroller. Using Timer1Gate allows the hardware to manage capturing of the reference signal low-edge pulse width, while allowing the PIC12F6XX to process other events for a given amount of time. The time will depend on the period of the signal being measured. In this case, there is a 2.5 kHz reference signal. This allows 400 μ s to go and process something else before we would need to read TIMER1 for a measurement.

C.9.2 Implementation

In this program, GP0 is used to output a test signal. If the PIC12F6XX internal RC oscillator is calibrated, the test signal will be a 5 kHz square wave. In addition, the program uses the GP3 push button input to select calibration mode. To turn on the 2.5 kHz fixed frequency source, select the box from the Board Controls area in the PICkit 1 Flash Starter Kit control panel. See Figure C-19 through Figure C-22 for program flowcharts.

C.9.3 Applications

This program could be useful in the following applications:

1. High volume production environment.
2. Battery applications could use on-board calibration to recalibrate the internal RC oscillator as the battery voltage drops.
3. Applications that are exposed to varying voltage and temperature ranges could have intelligent on-board recalibration.

C.9.4 Running The Demo

1. Program the autocal.hex code to the PIC12F6XX PIC microcontroller.
2. Once the device is programmed, LED D6 turns on indicating test mode.
3. Check the device calibration by connecting an oscilloscope probe or frequency counter to GP0 and compare the measurement to 5 kHz.
4. To calibrate the device, select the 2.5 kHz Osc checkbox and turn on the 2.5 kHz reference signal (in the Board Controls frame), as shown in Figure C-16. Press the SW1 button on the PICKit 1 Flash Starter Kit board. LED D7 will turn on when the button is pushed, this indicates calibration mode.
5. View the test signal output on GP0 using the oscilloscope, or frequency counter, and compare the measurements to the previous one before performing a calibration. The measurement will be within 1% of 5 kHz.

FIGURE C-16: PICKit 1 FLASH STARTER KIT PROGRAMMING INTERFACE

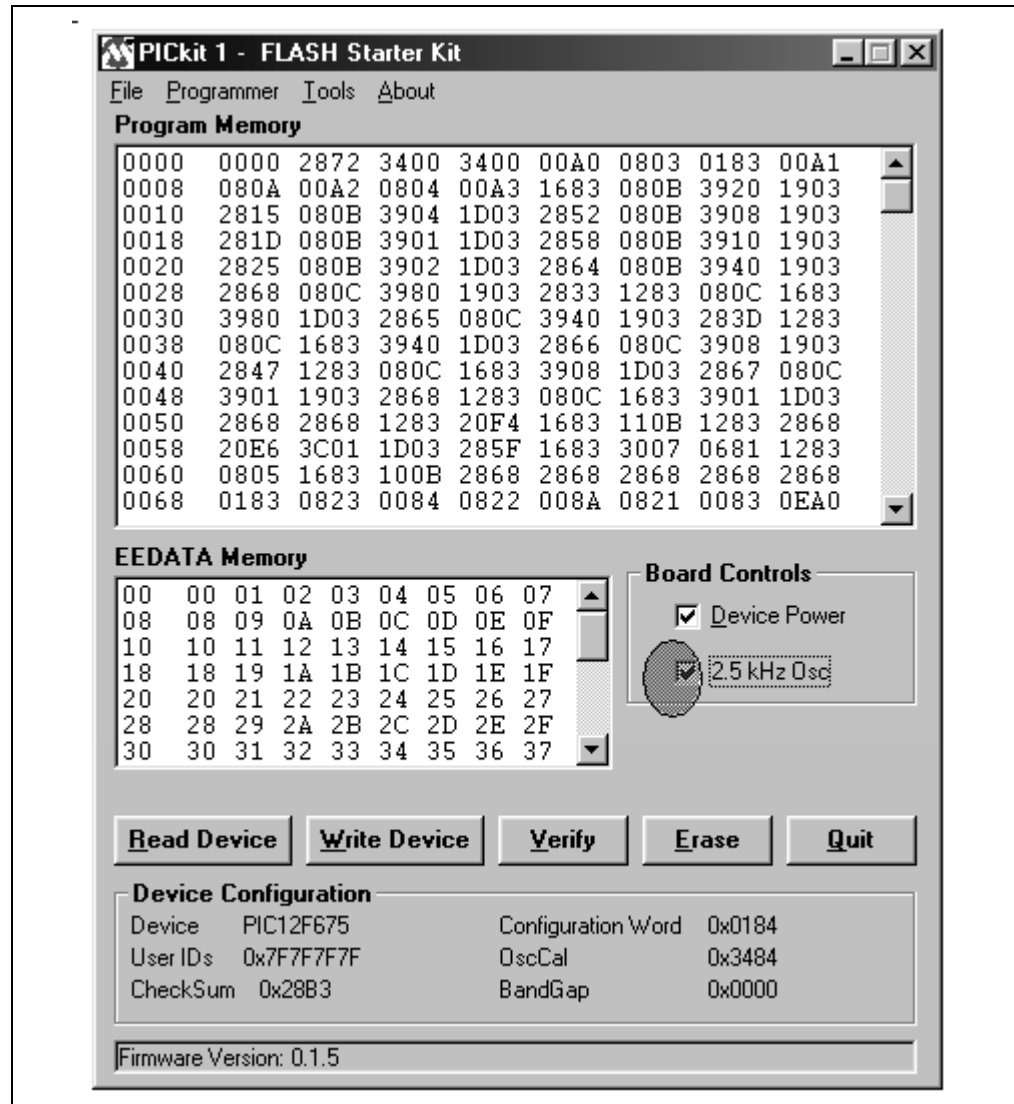

PICkit™ 1 Flash Starter Kit User's Guide

C.9.5 Modifying The Source Code

C.9.5.1 REQUIRED FILES FOR PROGRAM MODIFICATION

Assembly Code

- autocal.asm – This is the only file needed to build the project

FIGURE C-17: MPLAB PROJECT SETUP – ASSEMBLY

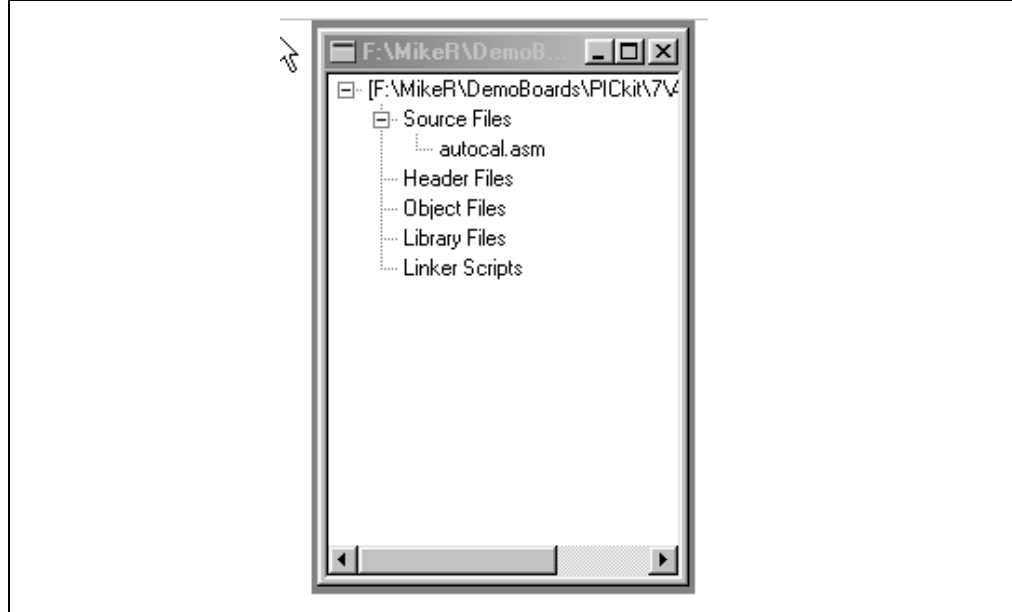

C Code

- autocal.c – This is the main file which contains the main program, interrupt routine and functions
- autocal.h – Header File
- delay.obj – Hi-Tech PICC Lite™ supplied delay function (Source code is located in C:\Picclite\samples\delay)

FIGURE C-18: MPLAB PROJECT SETUP – C

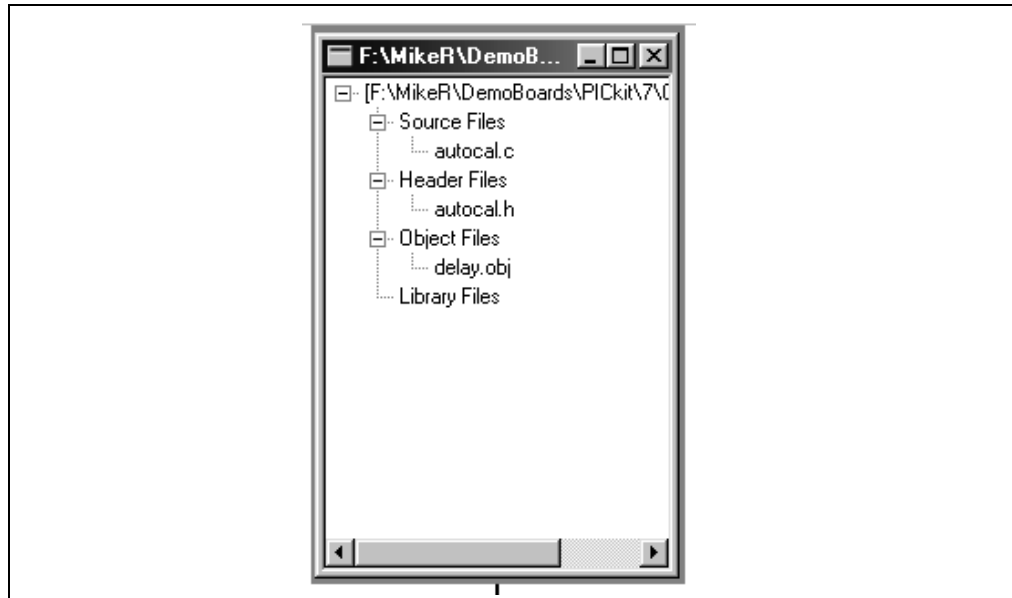

FIGURE C-19: MAIN FLOW

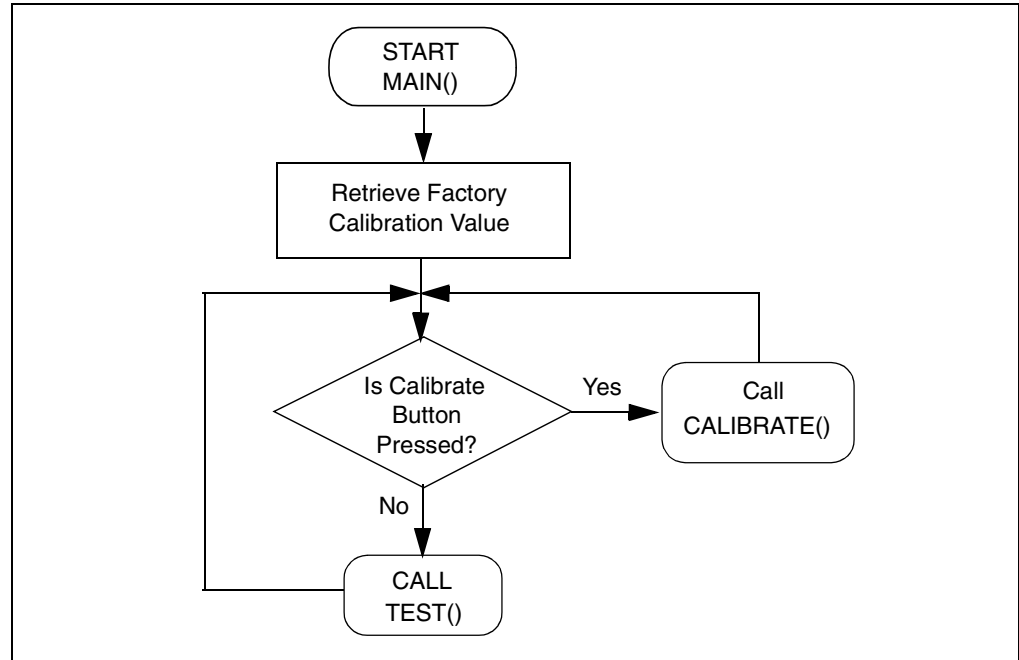

FIGURE C-20: TEST FLOW

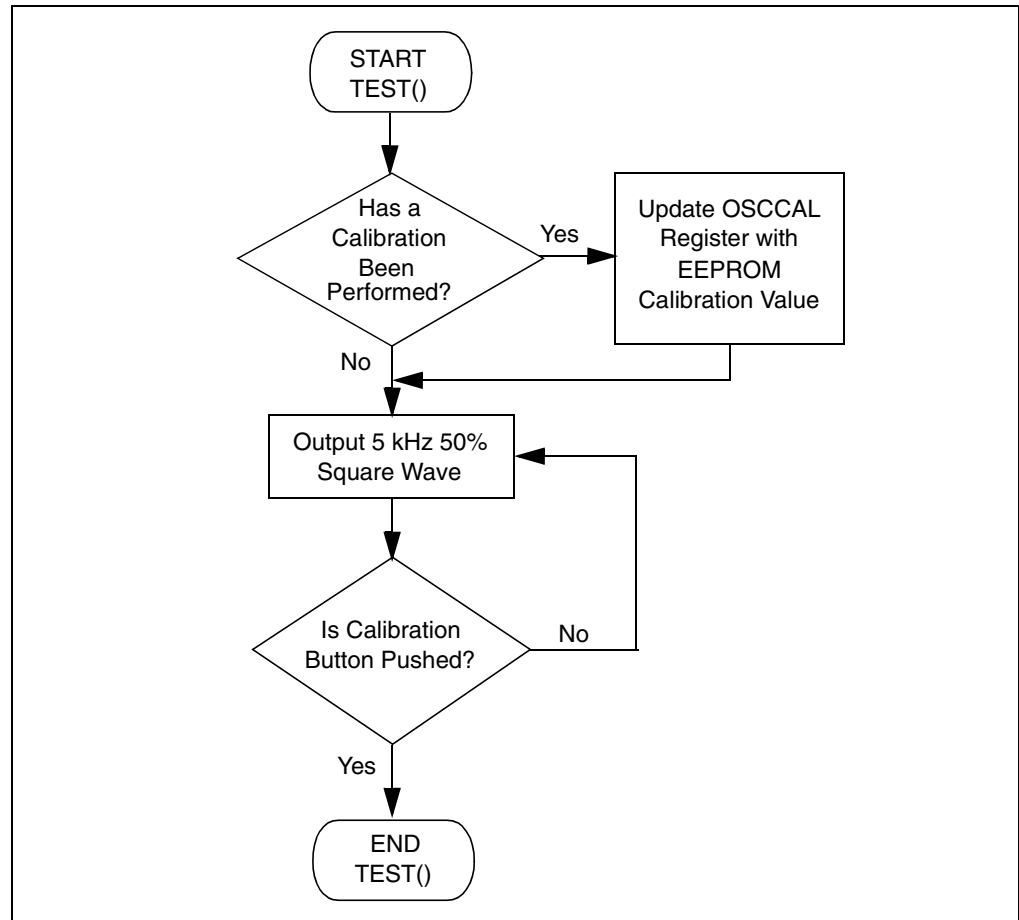

FIGURE C-21: CALIBRATE FLOW

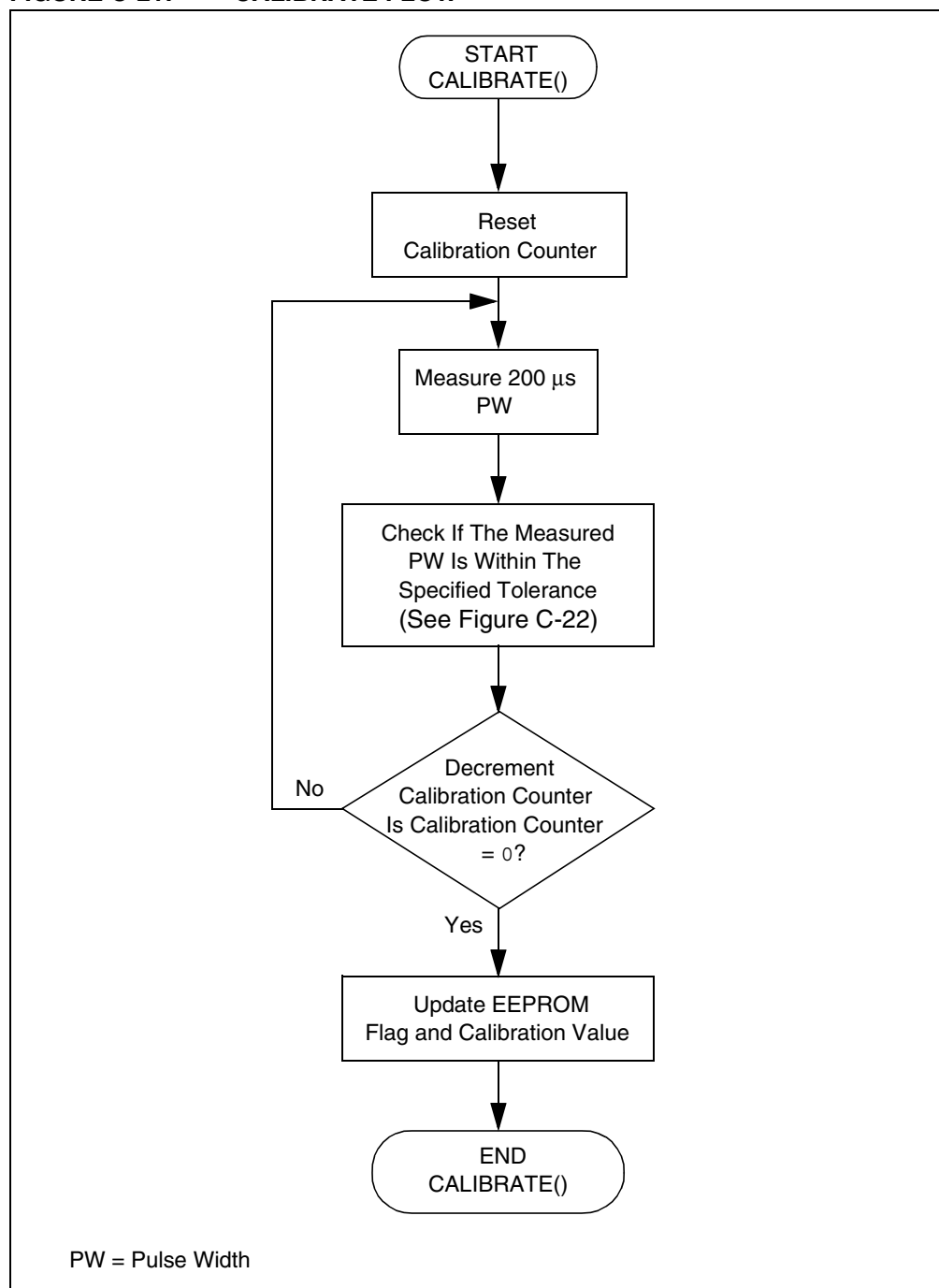
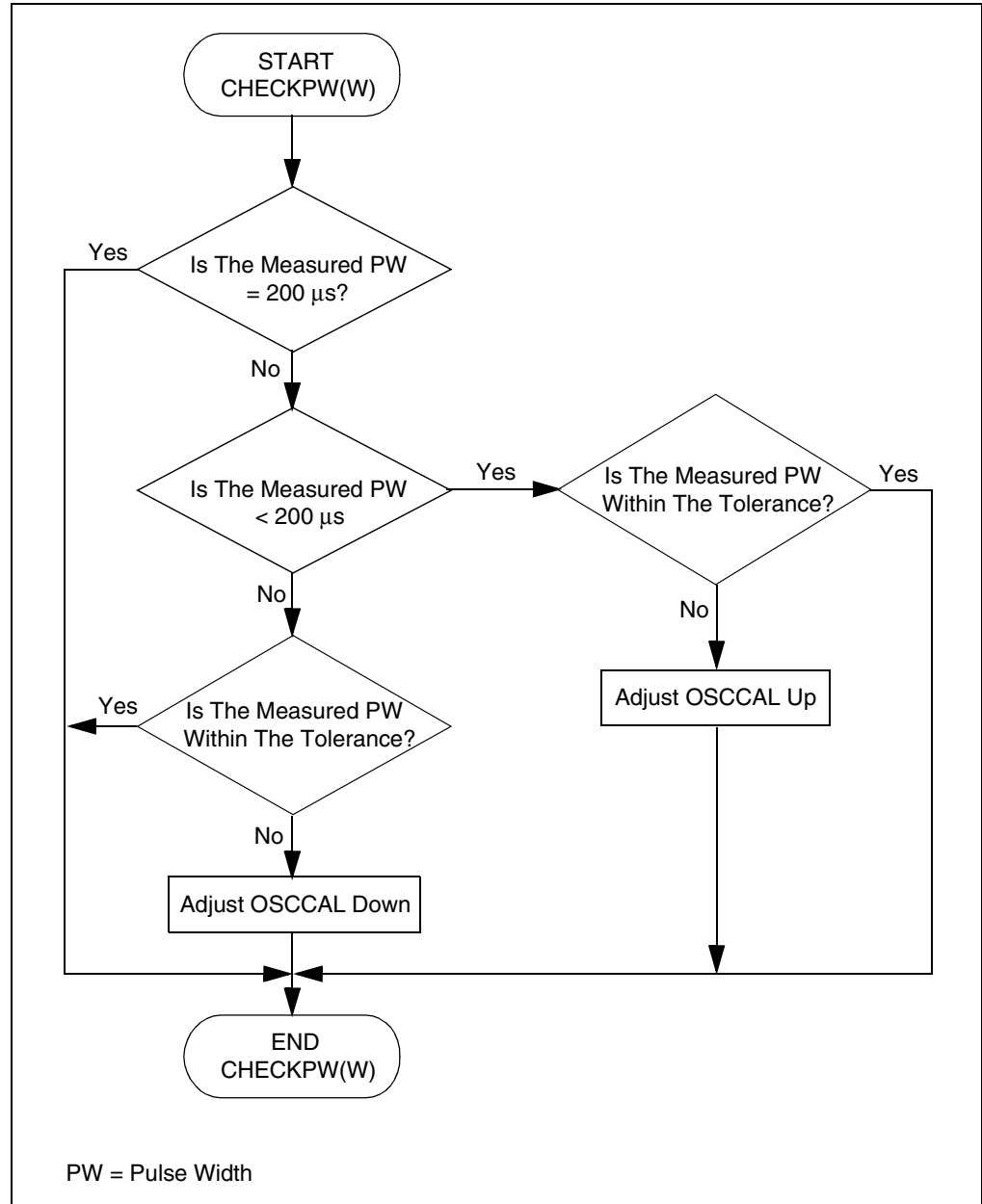

FIGURE C-22: CHECKPW(W) FLOW





WORLDWIDE SALES AND SERVICE

AMERICAS

Corporate Office

2355 West Chandler Blvd.
Chandler, AZ 85224-6199
Tel: 480-792-7200
Fax: 480-792-7277
Technical Support: 480-792-7627
Web Address: www.microchip.com

Atlanta

3780 Mansell Road, Suite 130
Alpharetta, GA 30022
Tel: 770-640-0034
Fax: 770-640-0307

Boston

2 Lan Drive, Suite 120
Westford, MA 01886
Tel: 978-692-3848
Fax: 978-692-3821

Chicago

333 Pierce Road, Suite 180
Itasca, IL 60143
Tel: 630-285-0071
Fax: 630-285-0075

Dallas

4570 Westgrove Drive, Suite 160
Addison, TX 75001
Tel: 972-818-7423
Fax: 972-818-2924

Detroit

Tri-Atria Office Building
32255 Northwestern Highway, Suite 190
Farmington Hills, MI 48334
Tel: 248-538-2250
Fax: 248-538-2260

Kokomo

2767 S. Albright Road
Kokomo, IN 46902
Tel: 765-864-8360
Fax: 765-864-8387

Los Angeles

18201 Von Karman, Suite 1090
Irvine, CA 92612
Tel: 949-263-1888
Fax: 949-263-1338

San Jose

1300 Terra Bella Avenue
Mountain View, CA 94043
Tel: 650-215-1444
Fax: 650-961-0286

Toronto

6285 Northam Drive, Suite 108
Mississauga, Ontario L4V 1X5, Canada
Tel: 905-673-0699
Fax: 905-673-6509

ASIA/PACIFIC

Australia

Suite 22, 41 Rawson Street
Epping 2121, NSW
Australia
Tel: 61-2-9868-6733
Fax: 61-2-9868-6755

China - Beijing

Unit 706B
Wan Tai Bei Hai Bldg.
No. 6 Chaoyangmen Bei Str.
Beijing, 100027, China
Tel: 86-10-85282100
Fax: 86-10-85282104

China - Chengdu

Rm. 2401-2402, 24th Floor,
Ming Xing Financial Tower
No. 88 TIDU Street
Chengdu 610016, China
Tel: 86-28-86766200
Fax: 86-28-86766599

China - Fuzhou

Unit 28F, World Trade Plaza
No. 71 Wusi Road
Fuzhou 350001, China
Tel: 86-591-7503506
Fax: 86-591-7503521

China - Hong Kong SAR

Unit 901-6, Tower 2, Metroplaza
223 Hing Fong Road
Kwai Fong, N.T., Hong Kong
Tel: 852-2401-1200
Fax: 852-2401-3431

China - Shanghai

Room 701, Bldg. B
Far East International Plaza
No. 317 Xian Xia Road
Shanghai, 200051
Tel: 86-21-6275-5700
Fax: 86-21-6275-5060

China - Shenzhen

Rm. 1812, 18/F, Building A, United Plaza
No. 5022 Binhe Road, Futian District
Shenzhen 518033, China
Tel: 86-755-82901380
Fax: 86-755-8295-1393

China - Shunde

Room 401, Hongjian Building, No. 2
Fengxiangnan Road, Ronggui Town, Shunde
District, Foshan City, Guangdong 528303, China
Tel: 86-757-28395507 Fax: 86-757-28395571

China - Qingdao

Rm. B505A, Fullhope Plaza,
No. 12 Hong Kong Central Rd.
Qingdao 266071, China
Tel: 86-532-5027355 Fax: 86-532-5027205

India

Divyasree Chambers
1 Floor, Wing A (A3/A4)
No. 11, O'Shaughnessy Road
Bangalore, 560 025, India
Tel: 91-80-22290061 Fax: 91-80-22290062

Japan

Benex S-1 6F
3-18-20, Shinyokohama
Kohoku-Ku, Yokohama-shi
Kanagawa, 222-0033, Japan
Tel: 81-45-471- 6166 Fax: 81-45-471-6122

Korea

168-1, Youngbo Bldg. 3 Floor
Samsung-Dong, Kangnam-Ku
Seoul, Korea 135-882
Tel: 82-2-554-7200 Fax: 82-2-558-5932 or
82-2-558-5934

Singapore

200 Middle Road
#07-02 Prime Centre
Singapore, 188980
Tel: 65-6334-8870 Fax: 65-6334-8850

Taiwan

Kaohsiung Branch
30F - 1 No. 8
Min Chuan 2nd Road
Kaohsiung 806, Taiwan
Tel: 886-7-536-4818
Fax: 886-7-536-4803

Taiwan

Taiwan Branch
11F-3, No. 207
Tung Hua North Road
Taipei, 105, Taiwan
Tel: 886-2-2717-7175 Fax: 886-2-2545-0139

EUROPE

Austria

Durisolstrasse 2
A-4600 Wels
Austria
Tel: 43-7242-2244-399
Fax: 43-7242-2244-393

Denmark

Regus Business Centre
Lautrup høj 1-3
Ballerup DK-2750 Denmark
Tel: 45-4420-9895 Fax: 45-4420-9910

France

Parc d'Activite du Moulin de Massy
43 Rue du Saule Trapu
Batiment A - Ier Etage
91300 Massy, France
Tel: 33-1-69-53-63-20
Fax: 33-1-69-30-90-79

Germany

Steinheilstrasse 10
D-85737 Ismaning, Germany
Tel: 49-89-627-144-0
Fax: 49-89-627-144-44

Italy

Via Quasimodo, 12
20025 Legnano (MI)
Milan, Italy
Tel: 39-0331-742611
Fax: 39-0331-466781

Netherlands

Waegenburghtplein 4
NL-5152 JR, Drunen, Netherlands
Tel: 31-416-690399
Fax: 31-416-690340

United Kingdom

505 Eskdale Road
Winnersh Triangle
Wokingham
Berkshire, England RG41 5TU
Tel: 44-118-921-5869
Fax: 44-118-921-5820

05/28/04