

THIS DRAWING IS UNPUBLISHED. RELEASED FOR PUBLICATION
 © COPYRIGHT - By - ALL RIGHTS RESERVED.

LOC	DIST	REVISIONS					
		P	LTR	DESCRIPTION	DATE	DWN	APVD
J	-	A	REVISED	ECR-13-018510	08JAN2014	TS	KB

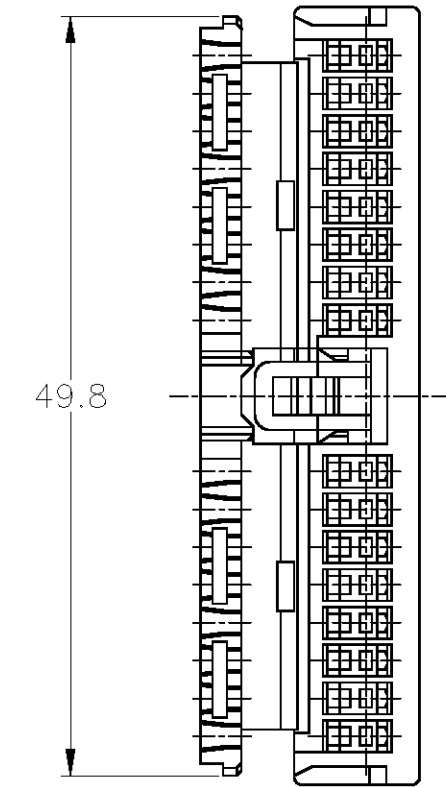

- ①. -T- 面より2mmの範囲で測定
 - 2. 適用端子型番 ; 173681, 175180
 - 3. 嵌合相手型番 ; 174062
-
- ①. TO BE MEASURED WITHIN 2mm FROM -T-
 - 2. APPLICABLE CONTACT PART NUMBER ; 173681, 175180
 - 3. THE MATING COUNTERPART PART NUMBER ; 174062

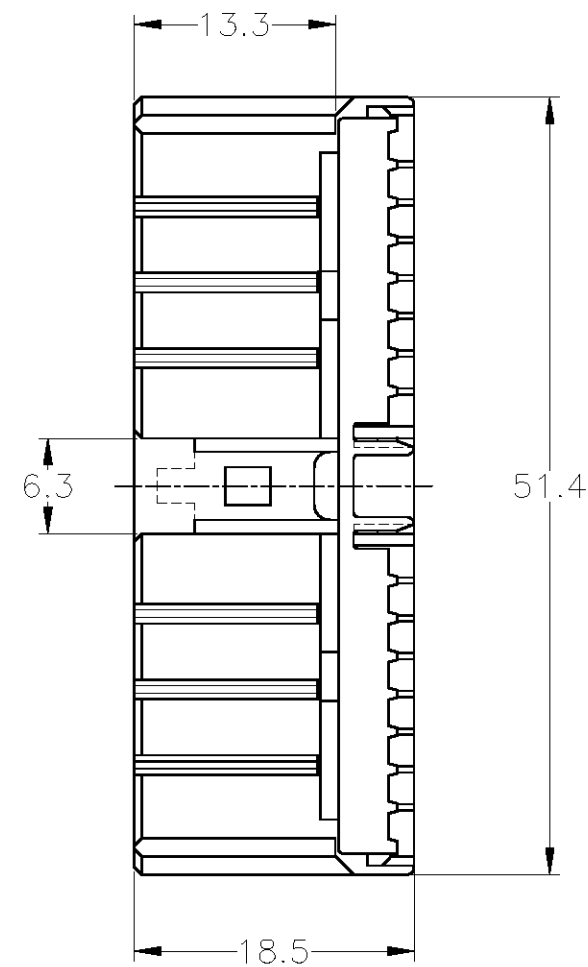
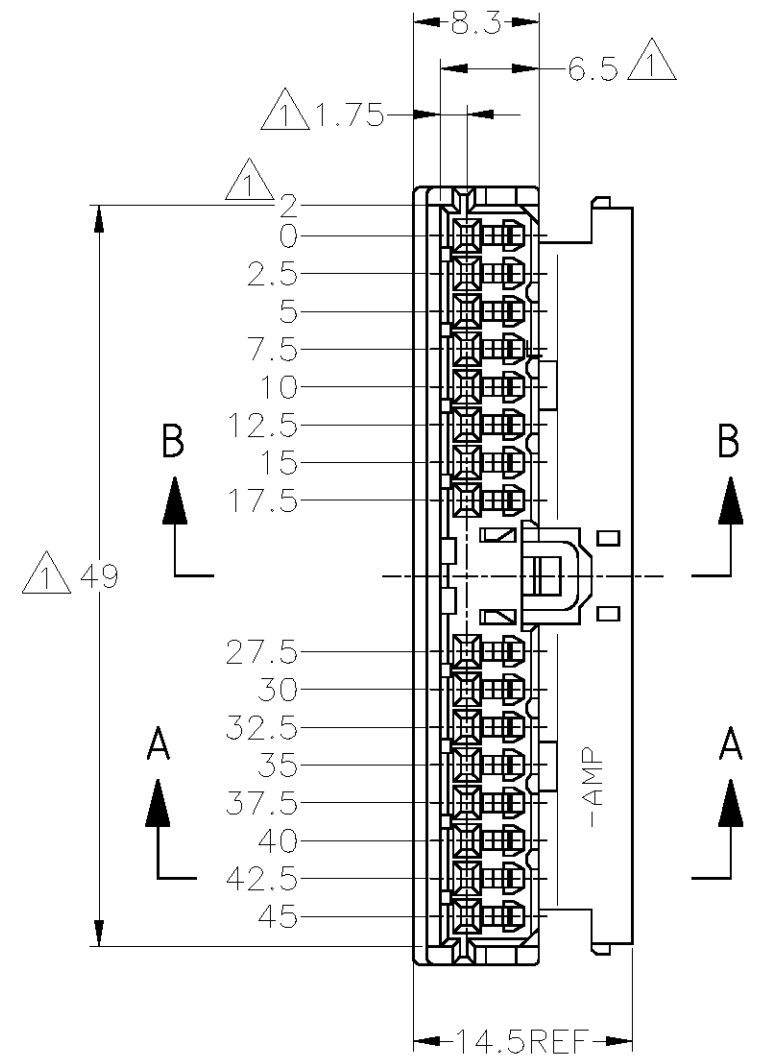
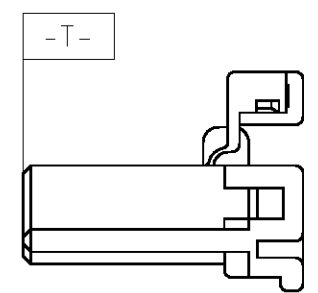
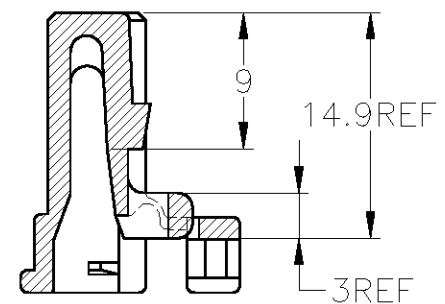
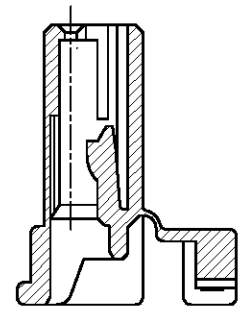

BLUE	174060-5
COLOR	PART NUMBER

GENERAL TOLERANCE
 一般公差

10 _≧	: ±0.2
30 _≧	>10 : ±0.25
100 _≧	>30 : ±0.3
ANGLE : ±3°	

THIS DRAWING IS A CONTROLLED DOCUMENT.		DWN	T.SHINOHARA	10FEB10	 TE Connectivity																	
DIMENSIONS: mm		CHK	K.BETSUI	10FEB10				NAME 16POSITION PLUG HOUSING MULTI LOCK I/O CONNECTOR LOW-PROFILE TYPE														
TOLERANCES UNLESS OTHERWISE SPECIFIED:		APVD	K.BETSUI	10FEB10																		
<table border="1"> <tr><td>0 PLC</td><td>± -</td></tr> <tr><td>1 PLC</td><td>± -</td></tr> <tr><td>2 PLC</td><td>± -</td></tr> <tr><td>3 PLC</td><td>± -</td></tr> <tr><td>4 PLC</td><td>± -</td></tr> <tr><td>ANGLES</td><td>± -</td></tr> <tr><td>FINISH</td><td>-</td></tr> </table>		0 PLC	± -	1 PLC				± -	2 PLC	± -	3 PLC	± -	4 PLC	± -	ANGLES	± -	FINISH	-	PRODUCT SPEC	108-5244		SIZE
0 PLC	± -																					
1 PLC	± -																					
2 PLC	± -																					
3 PLC	± -																					
4 PLC	± -																					
ANGLES	± -																					
FINISH	-																					
MATERIAL		PBT		APPLICATION SPEC	-		WEIGHT	3.85 g	A300779	C-174060	SCALE	2:1	SHEET	1 OF 1	REV	A						
CUSTOMER DRAWING																						