

FAN7080_F085 Half Bridge Gate Driver

Features

- Qualified to AEC Q100
- Floating channel designed for bootstrap operation fully operational to +600V
- Tolerance to negative transient voltage on VS pin
- VS-pin dv/dt immune.
- Gate drive supply range from 5.5V to 20V
- Under-voltage lockout
- CMOS Schmitt-triggered inputs with pull-down
- High side output in phase with input
- IN input is 3.3V/5V logic compatible and available on 15V input
- Matched propagation delay for both channels
- Dead time adjustable

Typical Applications

- Junction Box
- Half and full bridge application in the motor drive system

Description

The FAN7080_F085_F085 is a half-bridge gate drive IC with reset input and adjustable dead time control. It is designed for high voltage and high speed driving of MOSFET or IGBT, which operates up to 600V. Fairchild's high-voltage process and common-mode noise cancellation technique provide stable operation in the high side driver under high-dV/dt noise circumstances. An advanced level-shift circuit allows high-side gate driver operation up to VS=-5V (typical) at VBS=15V. Logic input is compatible with standard CMOS outputs. The UVLO circuits for both channels prevent from malfunction when VCC and VBS are lower than the specified threshold voltage. Combined pin function for dead time adjustment and reset shutdown make this IC packaged with space saving SOIC-8 Package. Minimum source and sink current capability of output driver is 250mA and 500mA respectively, which is suitable for junction box application and half and full bridge application in the motor drive system.



Ordering Information

| Device | Package | Operating Temp. |
|------------|---------|-----------------|
| FAN7080CM | SOIC-8 | -40 °C ~ 125 °C |
| FAN7080CMX | SOIC-8 | -40 °C ~ 125 °C |

X : Tape & Reel type

Block Diagrams

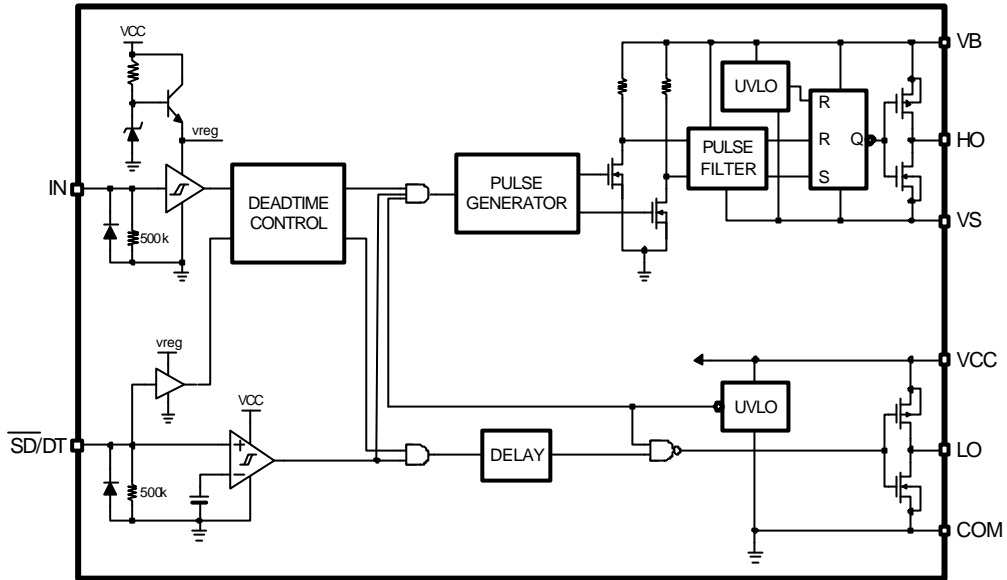

Pin Assignments

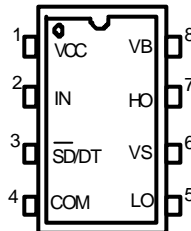

Pin Definitions

| Pin Number | Pin Name | I/O | Pin Function Description |
|------------|----------|-----|--|
| 1 | VCC | P | Driver supply voltage |
| 2 | IN | I | Logic input for high and low side gate drive output |
| 3 | SD/DT | I | Shut down input and dead time setting |
| 4 | COM | P | Ground |
| 5 | LO | A | Low side gate drive output for MOSFET Gate connection |
| 6 | VS | A | High side floating offset for MOSFET Source connection |
| 7 | HO | A | High side drive output for MOSFET Gate connection |
| 8 | VB | P | Driver output stage supply |

Absolute Maximum Ratings

Absolute Maximum Ratings indicate sustained limits beyond which damage to the device may occur. All voltage parameters are absolute voltages referenced to COM.

| Parameter | Symbol | Min. | Max. | Unit |
|--|-------------------|---------------------|-----------------------|------|
| High side floating supply offset voltage | V _s | V _B -25 | V _B +0.3 | V |
| High side floating supply voltage | V _B | -0.3 | 625 | V |
| High side floating output voltage | V _{HO} | V _s -0.3 | V _B +0.3 | V |
| Low side output voltage | V _{LO} | -0.3 | V _{CC} + 0.3 | V |
| Supply voltage | V _{CC} | -0.3 | 25 | V |
| Input voltage for IN | V _{IN} | -0.3 | V _{CC} +0.3 | V |
| Input injection current. Full function, no latch up;(Guaranteed by design). Test at 10V and 17V on Eng.Samples | I _{IN} | - | +1 | mA |
| Power Dissipation | P _d | | 0.625 | W |
| Thermal resistance, junction to ambient | R _{thja} | | 200 | °C/W |
| Electrostatic discharge voltage (Human Body Model) | V _{ESD} | 1K | | V |
| Charge device model | V _{CDM} | 500 | | V |
| Junction Temperature | T _j | | 150 | °C |
| Storage Temperature | T _s | -55 | 150 | °C |

Note: 1) The thermal resistance and power dissipation rating are measured below conditions;

JESD51-2: Integrated Circuit Thermal Test Method Environmental Conditions - Natural convection(StillAir)

JESD51-3 : Low Effective Thermal Conductivity Test Board for Leaded Surface Mount Package

Recommended Operating Conditions

For proper operation the device should be used within the recommended conditions.

| Parameter | Symbol | Min. | Max. | Unit |
|--|------------------------------|--------------------|---------------------|------|
| High side floating supply voltage(DC) Transient: -10V @ 0.1 us | V _B ¹⁾ | V _s + 6 | V _s + 20 | V |
| High side floating supply offset voltage(DC) Transient: -25V(max) @ 0.1us @ V _B <25V | V _s | -5 | 600 | V |
| High side floating output voltage | V _{HO} | V _s | V _B | V |
| Low side output voltage | V _{LO} | 0 | V _{CC} | V |
| Allowable offset voltage Slew Rate ²⁾ | dv/dt | - | 50 | V/ns |
| Supply voltage for logic part | V _{CC} | 5.5 | 20 | V |
| Logic input voltage | V _{IN} | 0 | V _{CC} | V |
| Switching Frequency ³⁾ | F _s | | 200 | KHz |
| Ambient Temperature | T _a | -40 | 125 | °C |

Note: 1) The V_s offset is tested with all supplies biased at 15V differential.

2) Guaranteed by design.

3) When V_{DT}= 1.2V.

Statics Electrical Characteristics

Unless otherwise specified, $-40^{\circ}\text{C} \leq T_a \leq 125^{\circ}\text{C}$, $V_{CC} = 15\text{V}$, $V_{BS} = 15\text{V}$, $V_S = 0\text{V}$, $C_L = 1\text{nF}$.

| Parameter | Symbol | Conditions | Min. | Typ. | Max. | Unit |
|---|----------------------------|--|------------|--------|----------|------------|
| Vcc and VBS supply Characteristics | | | | | | |
| Vcc and Vbs supply under voltage positive going threshold | V_{CCUV+} V_{BSUV+} | - | - | 4.2 | 5.5 | V |
| Vcc and Vbs supply under voltage negative going threshold | V_{CCUV-} V_{BSUV-} | - | 2.8 | 3.6 | - | V |
| Vcc and Vbs supply under voltage hysteresis | V_{CCUVH} V_{BSUVH} | - | 0.2 | 0.6 | - | V |
| Under voltage lockout response time | t_{duvcc} t_{duvbs} | VCC: 6V-->2.5V or 2.5V-->6V VBS: 6V-->2.5V or 2.5V-->6V | 0.5 0.5 | - - | 20 20 | us us |
| Offset supply leakage current | I_{LK} | $V_B = V_S = 600\text{V}$ | - | 20 | 50 | uA |
| Quiescent Vbs supply current | I_{QBS} | $V_{IN} = 0$ OR 5V , $V_{SDT} = 1.2\text{V}$ | 20 | 75 | 150 | uA |
| Quiescent Vcc supply current | I_{QCC} | $V_{IN} = 0$ OR 5 , $V_{SDT} = 1.2\text{V}$ | - | 350 | 1000 | uA |
| Input Characteristics | | | | | | |
| High logic level input voltage | V_{IH} | | 2.7 | - | - | V |
| Low logic level input voltage | V_{IL} | | - | - | 0.8 | V |
| High logic level input bias current for IN | I_{IN+} | $V_{IN} = 5\text{V}$ | - | 10 | 50 | uA |
| Low logic level input bias current for IN | I_{IN-} | $V_{IN} = 0\text{V}$ | - | 0 | 2 | uA |
| VSDT dead time setting range | V_{DT} | | 1.2 | - | 5 | V |
| VSDT shutdown threshold voltage | V_{SD} | | - | 0.8 | 1.2 | V |
| High logic level resistance for SD/DT | R_{SDT} | $V_{SDT} = 5\text{V}$ | 100 | 500 | 1100 | K Ω |
| Low logic level input bias current for SD/DT | I_{SDT-} | $V_{SDT} = 0\text{V}$ | - | 1 | 2 | uA |
| Output characteristics | | | | | | |
| High level output voltage, $V_{CC} - V_{HO}$ | $V_{OH(HO)}$ | $I_o = 0$ | - | - | 0.1 | V |
| Low level output voltage, V_{HO} | $V_{OL(HO)}$ | $I_o = 0$ | - | - | 0.1 | V |
| Output high short circuit pulse current | $I_{O+(HO)}$ | | 250 | 300 | - | mA |
| Output low short circuit pulse current | $I_{O-(HO)}$ | | 500 | 600 | - | mA |
| Equivalent output resistance | $R_{OP(HO)}$ | | - | - | 60 | Ω |
| | $R_{ON(HO)}$ | | - | - | 30 | Ω |
| High level output voltage, $V_B - V_{LO}$ | $V_{OH(LO)}$ | $I_o = 0$ | - | - | 0.1 | V |
| Low level output voltage, V_{LO} | $V_{OL(LO)}$ | $I_o = 0$ | - | - | 0.1 | V |
| Output high short circuit pulse current | $I_{O+(LO)}$ | | 250 | - | - | mA |
| Output low short circuit pulse current | $I_{O-(LO)}$ | | 500 | - | - | mA |
| Equivalent output resistance | $R_{OP(LO)}$ | | - | - | 60 | Ω |
| | $R_{ON(LO)}$ | | - | - | 30 | Ω |

Dynamic Electrical Characteristics

Unless otherwise specified, $-40^{\circ}\text{C} \leq T_a \leq 125^{\circ}\text{C}$, $V_{CC} = 15\text{V}$, $V_{BS} = 15\text{V}$, $V_S = 0\text{V}$, $C_L = 1\text{nF}$.

| Parameter | Symbol | Conditions | Min. | Typ. | Max. | Unit |
|---|--------|--|-------------|-------------|--------------|------|
| Turn-on propagation delay | ton | $V_S=0\text{V}$ | - | 750 | 1500 | ns |
| Turn-off propagation delay | toff | $V_S=0\text{V}$ | - | 130 | 250 | ns |
| Turn -on rising time | tr | - | - | 40 | 150 | ns |
| Turn -off falling time | tf | - | - | 25 | 400 | ns |
| Dead time, LS turn-off to HS turn-on and HS turn-on to LS turn-off | DT | $V_{IN}=0$ or 5V @ $V_{DT}=1.2\text{V}$ $V_{IN}=0$ or 5V @ $V_{DT}=3.3\text{V}$ | 250 1600 | 650 2100 | 1200 2600 | ns |
| Dead time matching time | MDT | DT1 -DT2 @ $V_{DT}=1.2\text{V}$ DT1 -DT2 @ $V_{DT}=3.3\text{V}$ | - | 35 - | 110 300 | ns |
| Delay Matching, HS and LS turn-on | MTON | $V_{DT}=1.2\text{V}$ | - | 25 | 110 | ns |
| Delay Matching, HS and LS turn-off | MTOFF | $V_{DT}=1.2\text{V}$ | - | 15 | 60 | ns |
| Shutdown propagation delay | Tsd | | - | 180 | 330 | ns |
| Switching Frequency | Fs1 | $V_{CC}=V_{BS}=20\text{V}$ | - | - | 200 | KHz |
| | Fs2 | $V_{CC}=V_{BS}=5.5\text{V}$ | - | - | 200 | KHz |

Typical Application Circuit

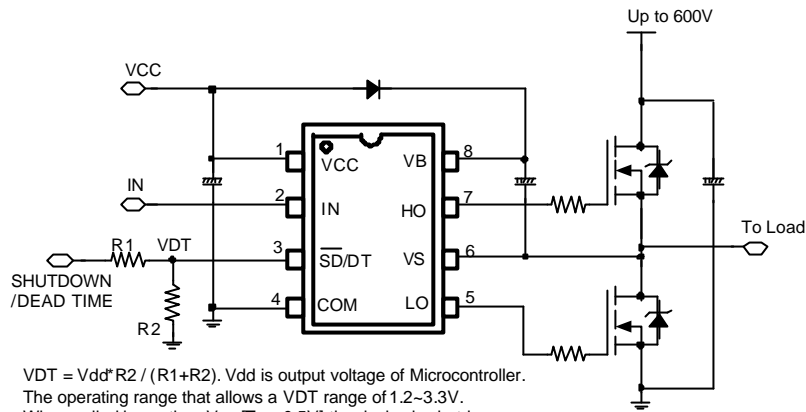

$VDT = V_{dd} \cdot R2 / (R1 + R2)$. V_{dd} is output voltage of Microcontroller.
 The operating range that allows a VDT range of 1.2~3.3V.
 When pulled lower than V_{DT} [Typ. 0.5V] the device is shutdown.
 Care must be taken to avoid below threshold spikes on pin 3 that can cause undesired shut down of the IC.
 For this reason the connection of the components between pin 3 and ground has to be as short as possible.
 And a capacitor (Typ 0.02 μ F) between pin3 and COM can prevent this spike. This pin can not be left floating for the same reason.

Typical Waveforms

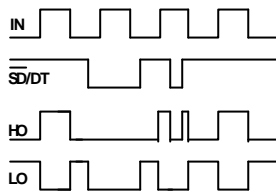

Figure 1. Input/output Timing Diagram

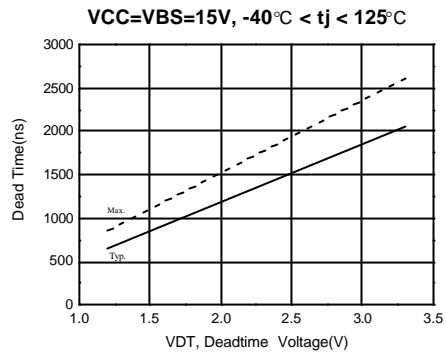

Figure 2. Dead Time VS VDT

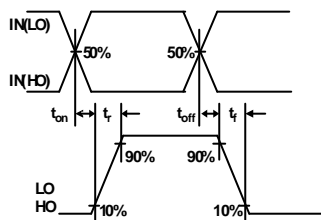

Figure 3. Switching Time Waveform Definitions

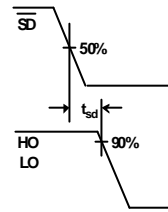

Figure 4. Shutdown Waveform Definitions

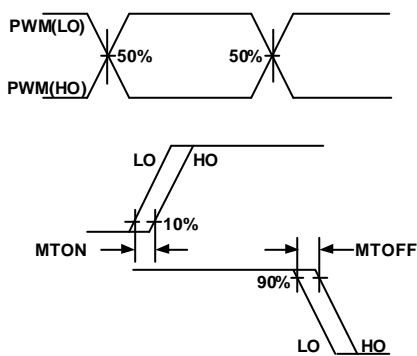

Figure 5. Delay Matching Waveform Definitions

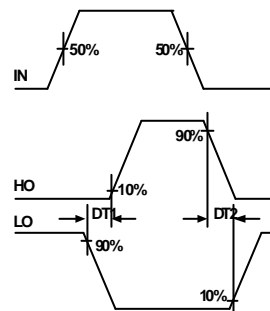

Figure 6. Dead Time Waveform Definitions

Performance Graphs (This performance graphs based on ambient temperature -40°C ~125 °C)

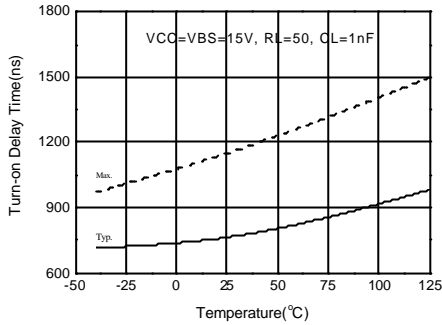

Figure 7a. Turn-On Delay Time of HO vs VBS Temperature

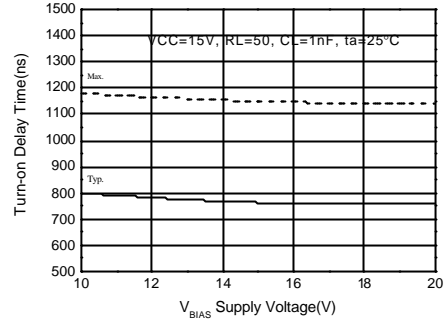

Figure 7b. Turn-On Delay Time of HO vs VBS Supply Voltage

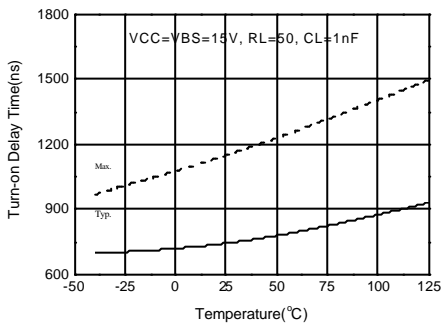

Figure 8a. Turn-On Delay Time of LO vs Temperature

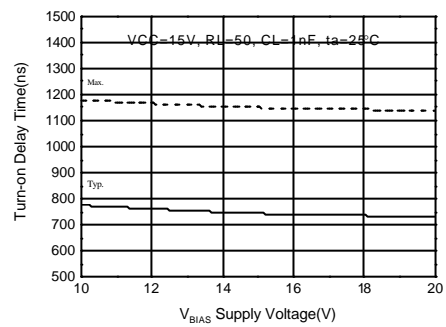

Figure 8b. Turn-On Delay Time vs of LO VBS Supply Voltage

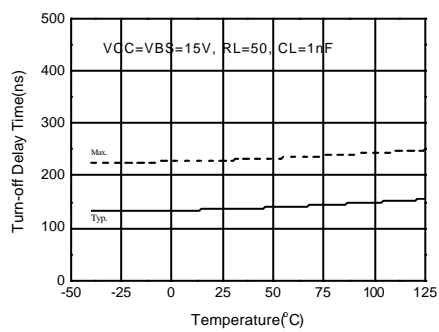

Figure 9a. Turn-Off Delay Time of HO vs Temperature

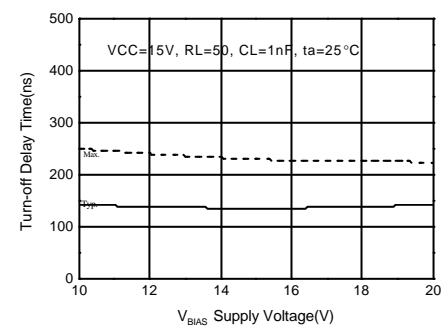

Figure 9b. Turn-Off Delay Time of HO vs VBS Supply Voltage

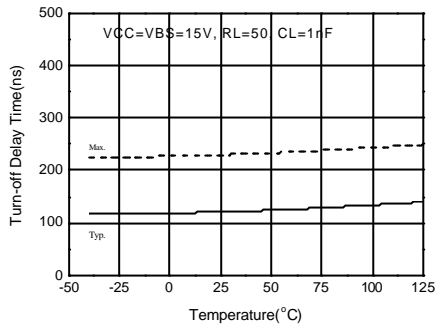

Figure 10a. Turn-Off Delay Time of LO vs Temperature

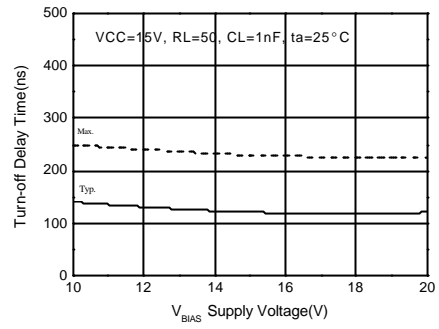

Figure 10b. Turn-Off Delay Time of LO vs VBS Supply Voltage

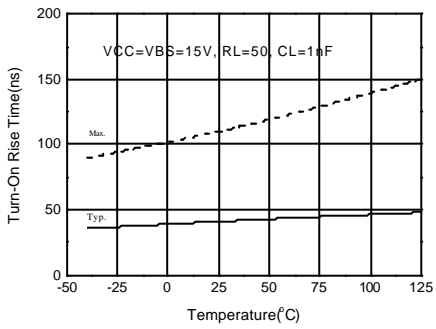

Figure 11a. Turn-On Rise Time of HO vs Temperature

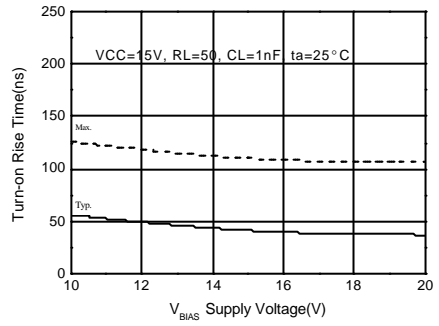

Figure 11b. Turn-On Rise Time vs of HO VBS Supply Voltage

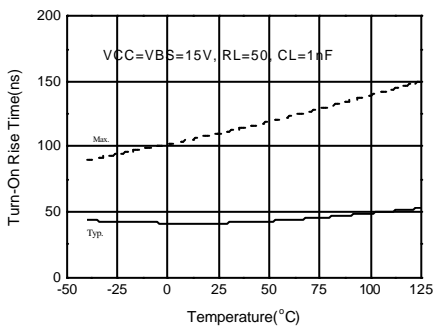

Figure 12a. Turn-On Rise Time of LO vs Temperature

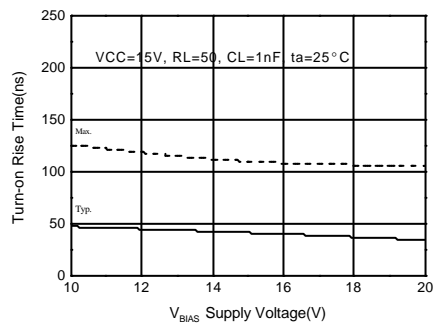

Figure 12b. Turn-On Rise Time of LO vs VBS Supply Voltage

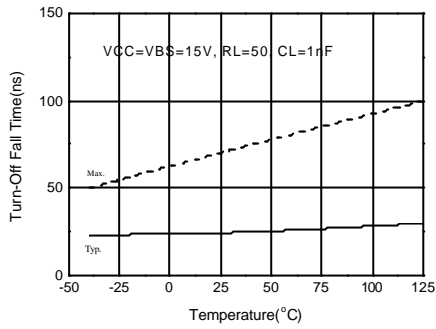

Figure 13a. Turn-Off Fall Time of HO vs Temperature

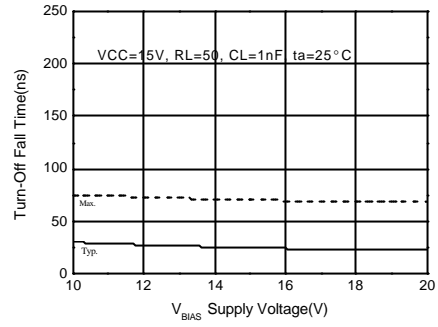

Figure 13b. Turn-Off Fall Time of HO vs VBS Supply Voltage

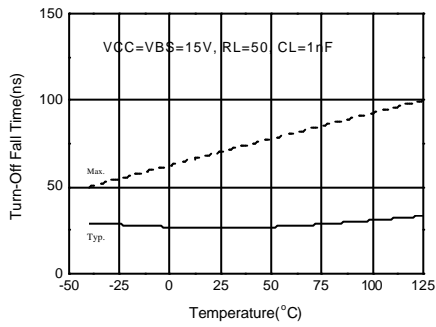

Figure 14a. Turn-Off Fall Time of LO vs Temperature

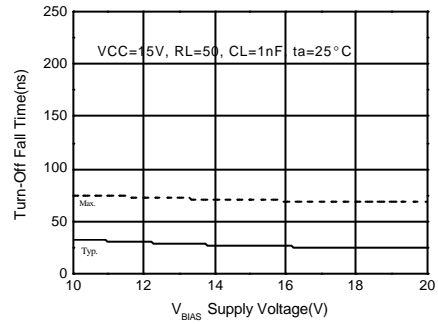

Figure 14b. Turn-Off Fall Time of LO vs BS Supply Voltage

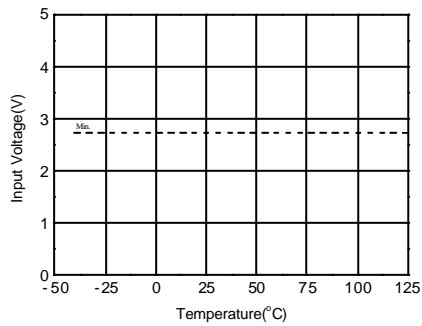

Figure 15a. Logic 0 Input Voltage vs Temperature

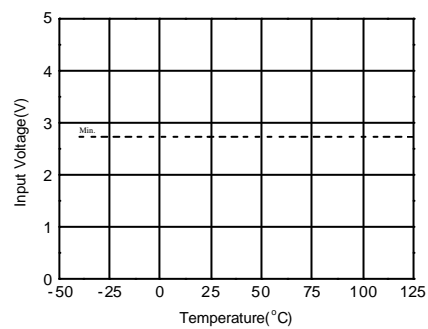

Figure 15b. Logic 1 Input Voltage vs Temperature

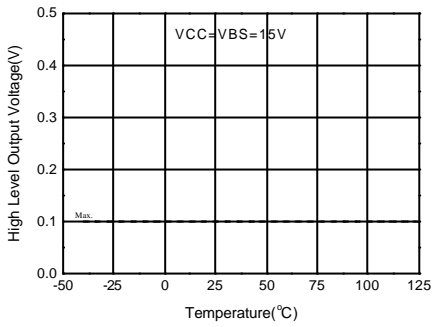

Figure 16a. High Level Output of HO vs Temperature

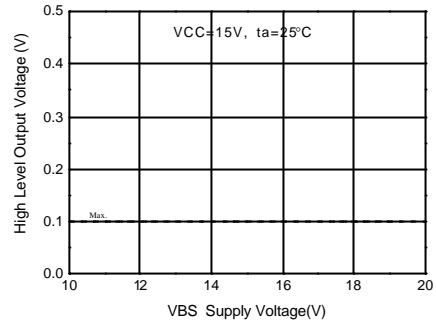

Figure 16b. High Level Output of HO vs VBS Supply Voltage

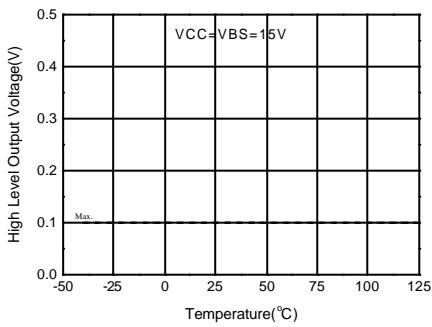

Figure 17a. High Level Output of LO vs Temperature

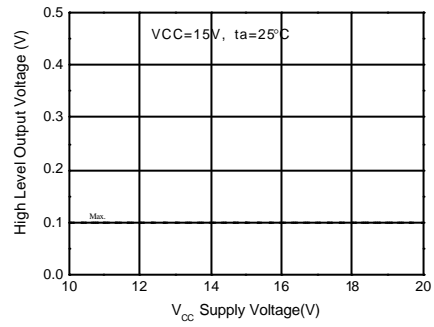

Figure 17b. High Level Output of LO vs VCC Supply Voltage

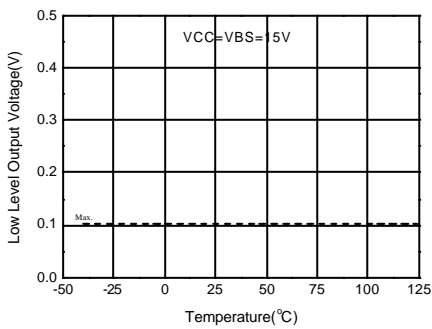

Figure 18a. Low Level Output of HO vs Temperature

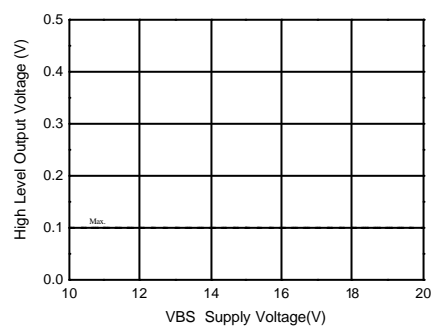

Figure 18b. Low Level Output of HO vs VBS Supply Voltage

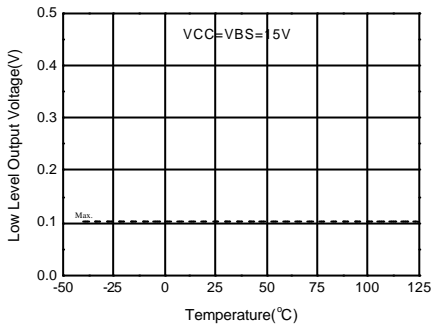

Figure 19a. Low Level Output of LO vs Temperature

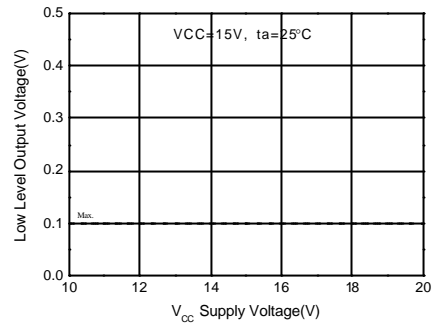

Figure 19b. Low Level Output of LO vs VCC Supply Voltage

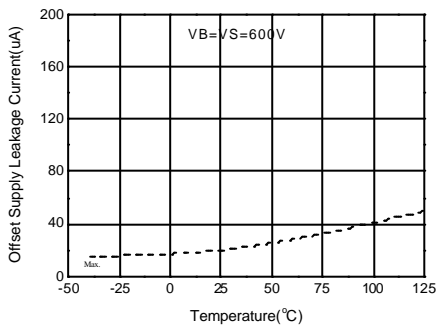

Figure 20a. Offset Supply leakage Current vs Temperature

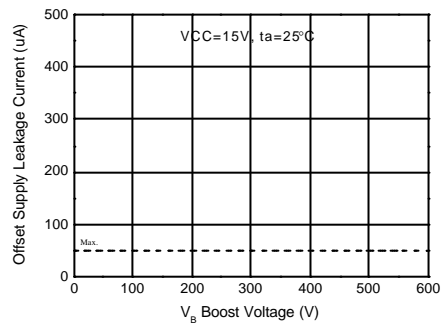

Figure 20b. Offset Supply leakage Current vs VB Boost Voltage

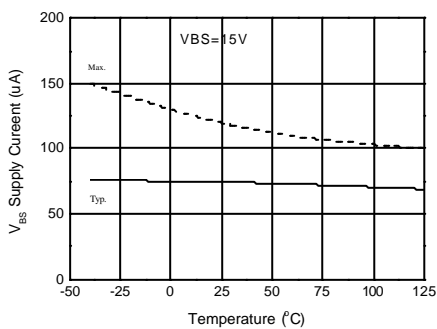

Figure 21. VBS Supply Current vs Temperature

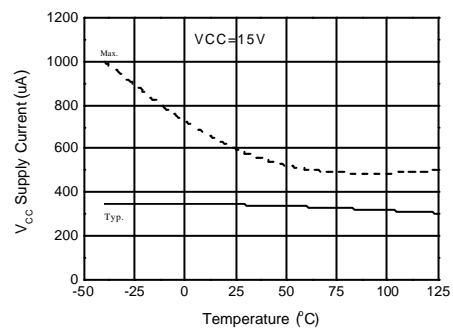

Figure 22. VCC Supply Current vs Temperature

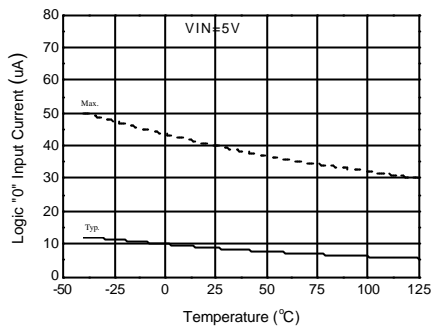

Figure 23a. Logic 1 Input Current vs Temperature

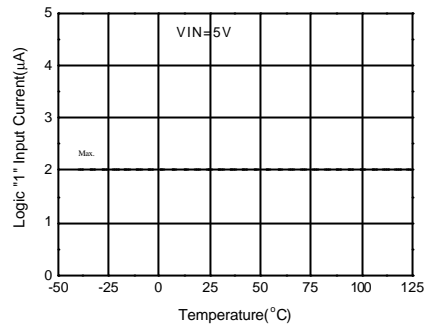

Figure 23b. Logic 0 Input Current vs Temperature

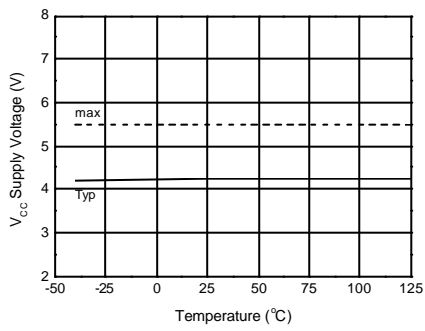

Figure 24a. VCC UnderVoltage Threshold (+) vs Temperature

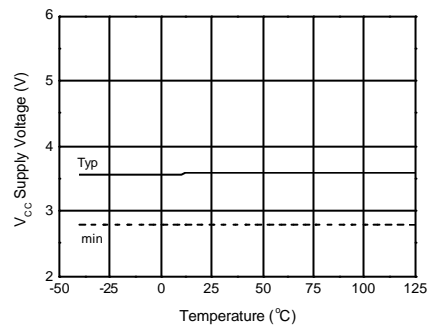

Figure 24b. VCC UnderVoltage Threshold(-) vs Temperature

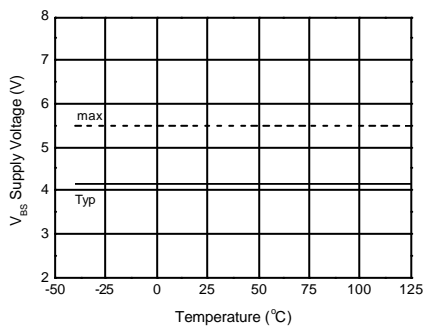

Figure 25a. VBS UnderVoltage Threshold (+) vs Temperature

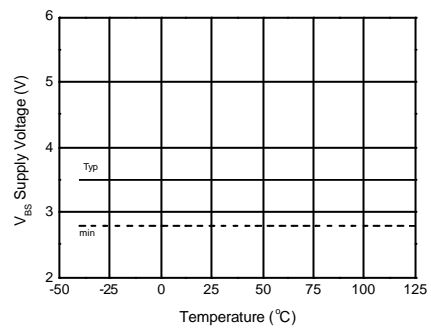

Figure 25b. VBS UnderVoltage Threshold(-) vs Temperature

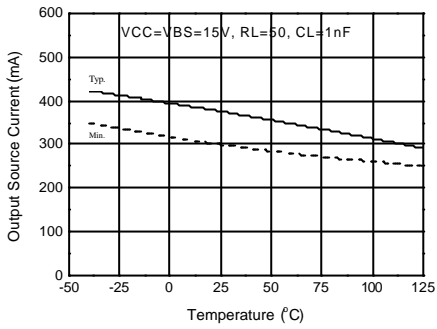

Figure 26a. Output Source Current of HO vs Temperature

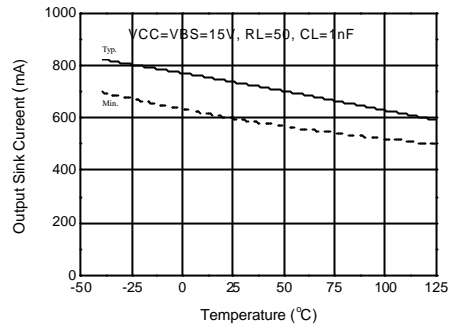

Figure 26b. Output Sink Current of HO vs Temperature

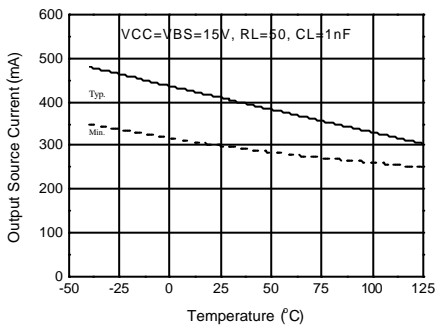

Figure 27a. Output Source Current of LO vs Temperature

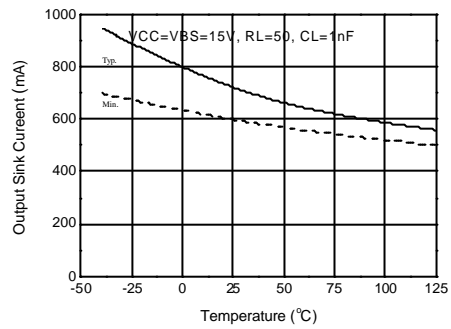

Figure 27b. Output Sink Current of LO vs Temperature

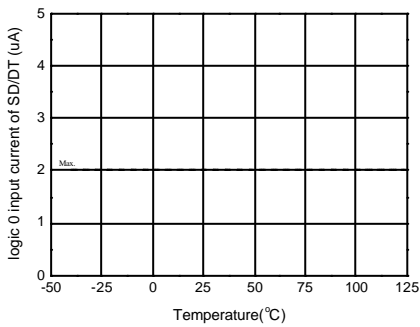

Figure 28. Logic 0 Input Current of SD/DT vs Temperature

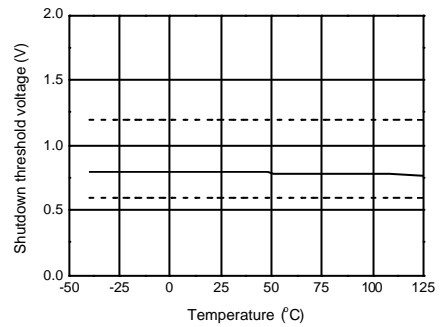

Figure 29. Shutdown Threshold of vs Temperature

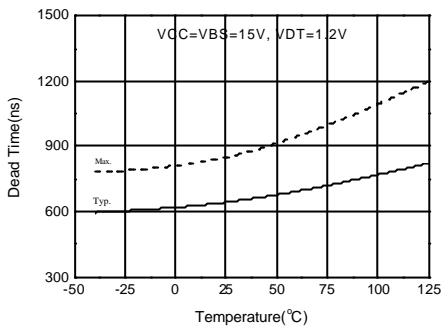

Figure 30. Deadtime vs Temperature

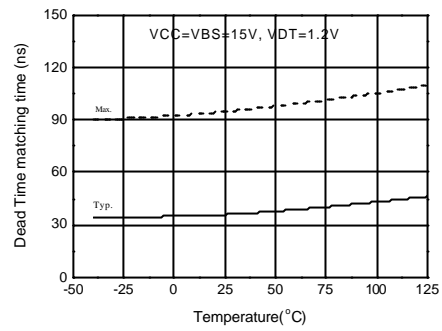

Figure 31. Deadtime Matching Time vs Temperature

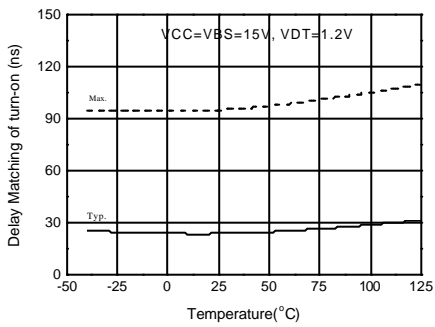

Figure 32. Turn-On Delay Matching vs Temperature

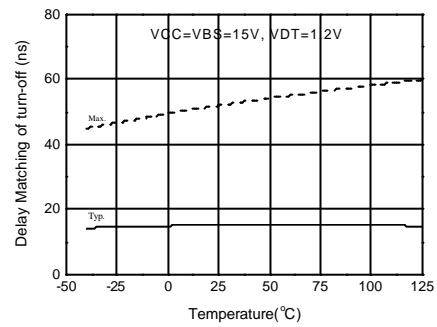

Figure 33. Turn_Off Delay Matching vs Temperature

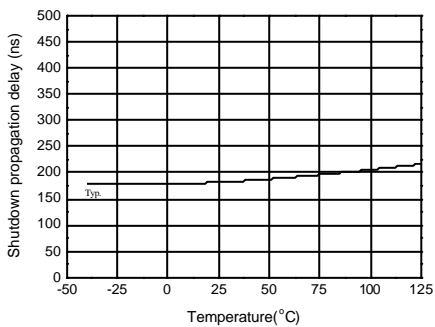

Figure 34. Shutdown Propagation Delay vs Temperature

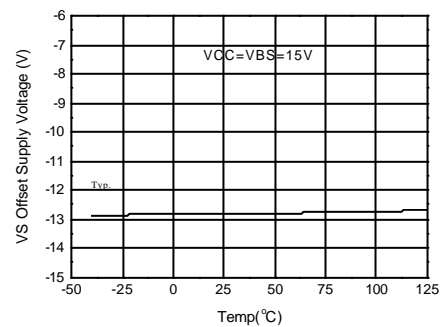
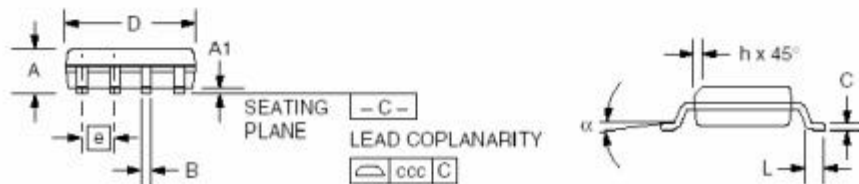
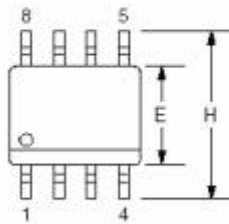

Figure 35. Maximum VS Negative Offset of vs Temperature

Package Dimensions

8-SOP

| Symbol | Inches | | Millimeters | | Notes |
|----------|----------|------|-------------|------|-------|
| | Min. | Max. | Min. | Max. | |
| A | .053 | .069 | 1.35 | 1.75 | |
| A1 | .004 | .010 | 0.10 | 0.25 | |
| B | .013 | .020 | 0.33 | 0.51 | |
| C | .0075 | .010 | 0.20 | 0.25 | 5 |
| D | .189 | .197 | 4.80 | 5.00 | 2 |
| E | .150 | .158 | 3.81 | 4.01 | 2 |
| e | .050 BSC | | 1.27 BSC | | |
| H | .228 | .244 | 5.79 | 6.20 | |
| h | .010 | .020 | 0.25 | 0.50 | |
| L | .016 | .050 | 0.40 | 1.27 | 3 |
| N | 8 | | 8 | | 6 |
| α | 0° | 8° | 0° | 8° | |
| ccc | — | | .004 | | |





Notes:

1. Dimensioning and tolerancing per ANSI Y14.5M-1982.
2. "D" and "E" do not include mold flash. Mold flash or protrusions shall not exceed .010 inch (0.25mm).
3. "L" is the length of terminal for soldering to a substrate.
4. Terminal numbers are shown for reference only.
5. "C" dimension does not include solder finish thickness.
6. Symbol "N" is the maximum number of terminals.



TRADEMARKS

The following includes registered and unregistered trademarks and service marks, owned by Fairchild Semiconductor and/or its global subsidiaries, and is not intended to be an exhaustive list of all such trademarks.

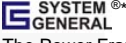
- | | | | |
|--|---|--|---|
| Build it Now™ | FRFET® | Programmable Active Droop™ | the power franchise |
| CorePLUS™ | Global Power Resource SM | QFET® | TinyBoost™ |
| CorePOWER™ | Green FPS™ | QS™ | TinyBuck™ |
| CROSSVOLT™ | Green FPS™ e-Series™ | Quiet Series™ | TinyLogic® |
| CTL™ | GTO™ | RapidConfigure™ | TINYOPTO™ |
| Current Transfer Logic™ | IntelliMAX™ |  ™ | TinyPower™ |
| EcoSPARK® | ISOPLANAR™ | Saving our world, 1mW/W/kW at a time™ | TinyPWM™ |
| EfficientMax™ | MegaBuck™ | SmartMax™ | TinyWire™ |
| EZSWITCH™* | MICROCOUPLER™ | SMART START™ | TriFault Detect™ |
|  ™* | MicroFET™ | SPM® | TRUECURRENT™* |
|  ® | MicroPak™ | STEALTH™ | µSerDes™ |
| Fairchild® | MillerDrive™ | SuperFET™ |  ™ |
| Fairchild Semiconductor® | MotionMax™ | SuperSOT™-3 | UHC® |
| FACT Quiet Series™ | Motion-SPM™ | SuperSOT™-6 | Ultra FRFET™ |
| FACT® | OPTOLOGIC® | SuperSOT™-8 | UniFET™ |
| FAST® | OPTOPLANAR® | SupreMOS™ | VCX™ |
| FastvCore™ |  ® | SyncFET™ | VisualMax™ |
| FlashWriter®* | PDP SPM™ |  ®* | XS™ |
| FPS™ | Power-SPM™ | The Power Franchise® | |
| F-PFS™ | PowerTrench® | | |
| | PowerXS™ | | |

* Trademarks of System General Corporation, used under license by Fairchild Semiconductor.

DISCLAIMER

FAIRCHILD SEMICONDUCTOR RESERVES THE RIGHT TO MAKE CHANGES WITHOUT FURTHER NOTICE TO ANY PRODUCTS HEREIN TO IMPROVE RELIABILITY, FUNCTION, OR DESIGN. FAIRCHILD DOES NOT ASSUME ANY LIABILITY ARISING OUT OF THE APPLICATION OR USE OF ANY PRODUCT OR CIRCUIT DESCRIBED HEREIN; NEITHER DOES IT CONVEY ANY LICENSE UNDER ITS PATENT RIGHTS, NOR THE RIGHTS OF OTHERS. THESE SPECIFICATIONS DO NOT EXPAND THE TERMS OF FAIRCHILD'S WORLDWIDE TERMS AND CONDITIONS, SPECIFICALLY THE WARRANTY THEREIN, WHICH COVERS THESE PRODUCTS.

LIFE SUPPORT POLICY

FAIRCHILD'S PRODUCTS ARE NOT AUTHORIZED FOR USE AS CRITICAL COMPONENTS IN LIFE SUPPORT DEVICES OR SYSTEMS WITHOUT THE EXPRESS WRITTEN APPROVAL OF FAIRCHILD SEMICONDUCTOR CORPORATION.

As used herein:

- Life support devices or systems are devices or systems which, (a) are intended for surgical implant into the body or (b) support or sustain life, and (c) whose failure to perform when properly used in accordance with instructions for use provided in the labeling, can be reasonably expected to result in a significant injury of the user.
- A critical component in any component of a life support, device, or system whose failure to perform can be reasonably expected to cause the failure of the life support device or system, or to affect its safety or effectiveness.

ANTI-COUNTERFEITING POLICY

Fairchild Semiconductor Corporation's Anti-Counterfeiting Policy. Fairchild's Anti-Counterfeiting Policy is also stated on our external website, www.fairchildsemi.com, under Sales Support.

Counterfeiting of semiconductor parts is a growing problem in the industry. All manufacturers of semiconductor products are experiencing counterfeiting of their parts. Customers who inadvertently purchase counterfeit parts experience many problems such as loss of brand reputation, substandard performance, failed applications, and increased cost of production and manufacturing delays. Fairchild is taking strong measures to protect ourselves and our customers from the proliferation of counterfeit parts. Fairchild strongly encourages customers to purchase Fairchild parts either directly from Fairchild or from Authorized Fairchild Distributors who are listed by country on our web page cited above. Products customers buy either from Fairchild directly or from Authorized Fairchild Distributors are genuine parts, have full traceability, meet Fairchild's quality standards for handling and storage and provide access to Fairchild's full range of up-to-date technical and product information. Fairchild and our Authorized Distributors will stand behind all warranties and will appropriately address any warranty issues that may arise. Fairchild will not provide any warranty coverage or other assistance for parts bought from Unauthorized Sources. Fairchild is committed to combat this global problem and encourage our customers to do their part in stopping this practice by buying direct or from authorized distributors.

PRODUCT STATUS DEFINITIONS

Definition of Terms

| Datasheet Identification | Product Status | Definition |
|--------------------------|-----------------------|---|
| Advance Information | Formative / In Design | Datasheet contains the design specifications for product development. Specifications may change in any manner without notice. |
| Preliminary | First Production | Datasheet contains preliminary data; supplementary data will be published at a later date. Fairchild Semiconductor reserves the right to make changes at any time without notice to improve design. |
| No Identification Needed | Full Production | Datasheet contains final specifications. Fairchild Semiconductor reserves the right to make changes at any time without notice to improve the design. |
| Obsolete | Not In Production | Datasheet contains specifications on a product that is discontinued by Fairchild Semiconductor. The datasheet is for reference information only. |