

## Technical Data Sheet Power Top View LED

### 67-31A/B7C-AT1U2MZ3/2T

#### Features

- P-LCC-3 package.
- High flux output.
- High current capability.
- White package.
- Optical indicator.
- Colorless clear window.
- Ideal for backlight and light pipe application.
- Inter reflector.
- Wide viewing angle.
- Suitable for automatic placement equipment.
- Suitable for reflow and wave solder processes.
- Available on tape and reel (8mm Tape).
- Pb-free.
- The product itself will remain within RoHS compliant version.



#### Descriptions

- The 67-31A series is available in soft orange, red and yellow. Due to the package design, the LED has wide viewing angle and optimized light coupling by inter reflector.
- This feature makes the ideal for light pipe application. The low current requirement makes this device ideal for portable equipment or any other application where power is at a premium.

#### Applications

- Indicator and backlight for audio and video equipment.
- Indicator and backlight in office and family equipment.
- Flat backlight for LCD's, switches and symbols.
- Light pipe application.
- General use.

#### Device Selection Guide

Chip	Emitted Color	Resin Color
Material		
InGaN	Blue	Water Clear

**Technical Data Sheet**  
**Power Top View LED**

**67-31A/B7C-AT1U2MZ3/2T**

**Package Dimensions**

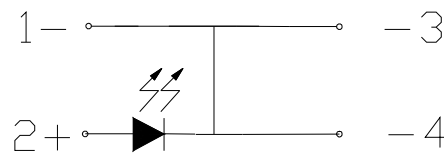
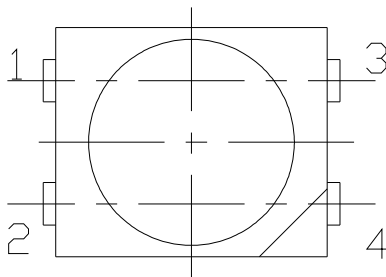

**Polarity**

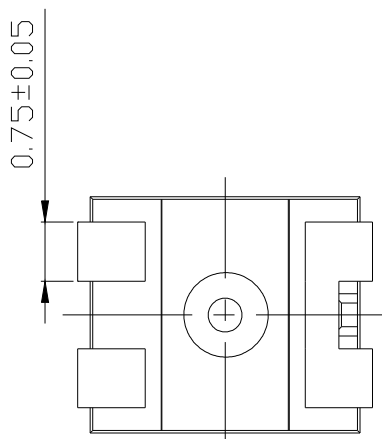
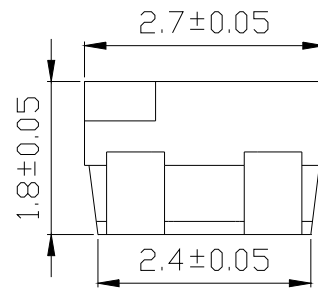
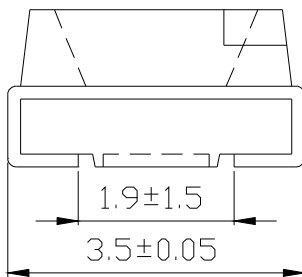

**Recommended soldering pad design**

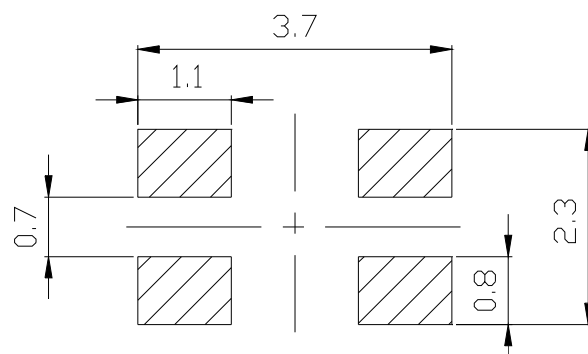

**Note:** The tolerances unless mentioned is  $\pm 0.1$ mm ;Unit = mm

Technical Data Sheet  
Power Top View LED

**67-31A/B7C-AT1U2MZ3/2T**

**Absolute Maximum Ratings (T<sub>A</sub>=25 )**

Parameter	Symbol	Rating	Unit
Reverse Voltage	V <sub>R</sub>	5	V
Forward Current	I <sub>F</sub>	30	mA
Peak Forward Current (Duty 1/10 @1KHz)	I <sub>FP</sub>	100	mA
Power Dissipation	P <sub>d</sub>	110	mW
Electrostatic Discharge(HBM)	ESD	150	V
Operating Temperature	T <sub>opr</sub>	-40 ~ +85	
Storage Temperature	T <sub>stg</sub>	-40 ~ +90	
Soldering Temperature	T <sub>sol</sub>	Reflow Soldering : 260 Hand Soldering : 350	for 10 sec. for 3 sec.

**Electronic Optical Characteristics :**

Parameter	Symbol	Min.	Typ.	Max.	Unit	Condition
Luminous Intensity	I <sub>v</sub>	285	-----	715	mcd	I <sub>F</sub> =30mA
Viewing Angle	2 1/2	-----	120	-----	deg	I <sub>F</sub> =30mA
Peak Wavelength	λ <sub>p</sub>	-----	468	-----	nm	I <sub>F</sub> =30mA
Dominant Wavelength	λ <sub>d</sub>	464.5	-----	476.5	nm	I <sub>F</sub> =30mA
Spectrum Radiation Bandwidth		-----	35	-----	nm	I <sub>F</sub> =30mA
Forward Voltage	V <sub>F</sub>	2.75	-----	3.95	V	I <sub>F</sub> =30mA
Reverse Current	I <sub>R</sub>	-----	-----	10	μ A	V <sub>R</sub> =5V

**Notes:**

- 1.Tolerance of Luminous Intensity ±11%
- 2.Tolerance of Dominant Wavelength ±1nm
- 3.Tolerance of Forward Voltage ±0.1V

**Technical Data Sheet**  
**Power Top View LED**

**67-31A/B7C-AT1U2MZ3/2T**

**Bin Range of Dominant Wavelengths**

Group	Bin Code	Min.	Max.	Unit	Condition
A	A9	464.5	467.5	nm	I <sub>F</sub> =30mA
	A10	467.5	470.5		
	A11	470.5	473.5		
	A12	473.5	476.5		

**Bin Range of Luminous Intensity**

Bin	Min	Max	Unit	Condition
T1	285	360	mcd	I <sub>F</sub> =30mA
T2	360	450		
U1	450	565		
U2	565	715		

**Bin Range of Forward Voltage**

Group	Bin	Min	Max	Unit	Condition
M	5	2.75	3.05	V	I <sub>F</sub> =30mA
	6	3.05	3.35		
	7	3.35	3.65		
	8	3.65	3.95		

**Notes:**

- 1.Tolerance of Luminous Intensity  $\pm 11\%$
- 2.Tolerance of Dominant Wavelength  $\pm 1\text{nm}$
- 3.Tolerance of Forward Voltage  $\pm 0.1\text{V}$

**Technical Data Sheet**  
**Power Top View LED**

**67-31A/B7C-AT1U2MZ3/2T**

**Typical Electro-Optical Characteristic Curves**

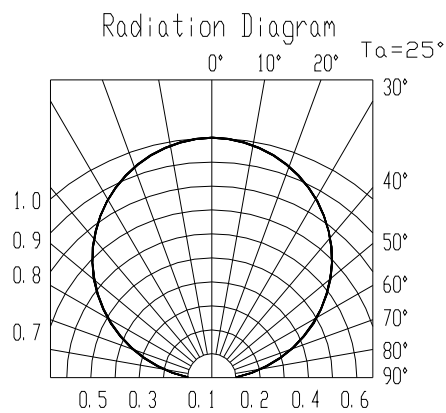
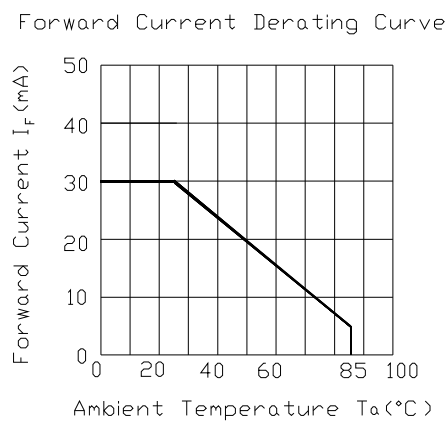
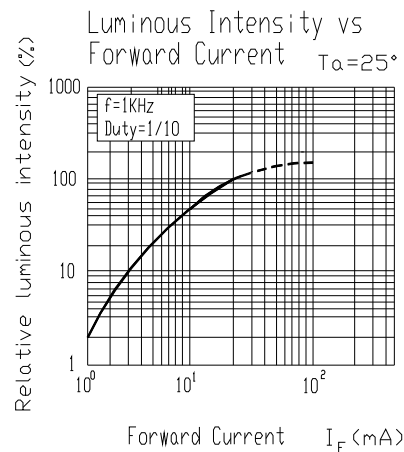
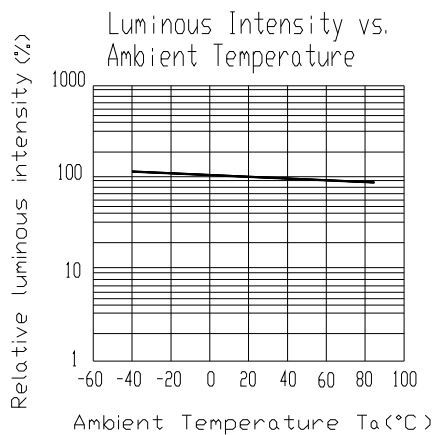
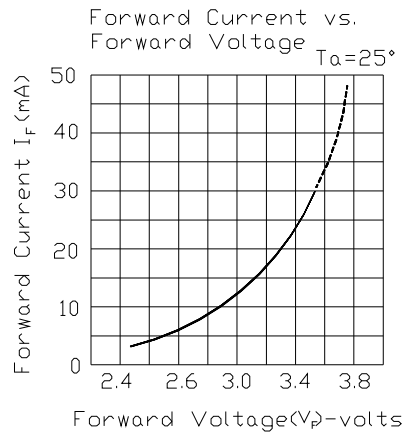
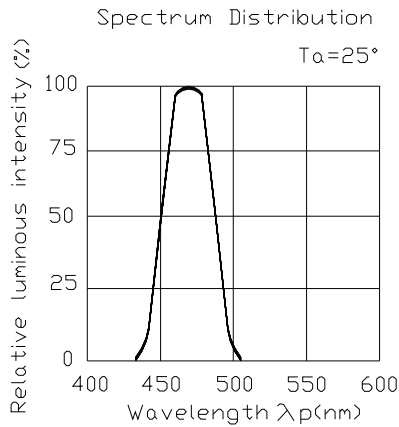

**Technical Data Sheet**  
**Power Top View LED**

**67-31A/B7C-AT1U2MZ3/2T**

**Label Explanation**

CAT: Luminous Intensity Rank  
HUE: Dom. Wavelength Rank  
REF: Forward Voltage Rank

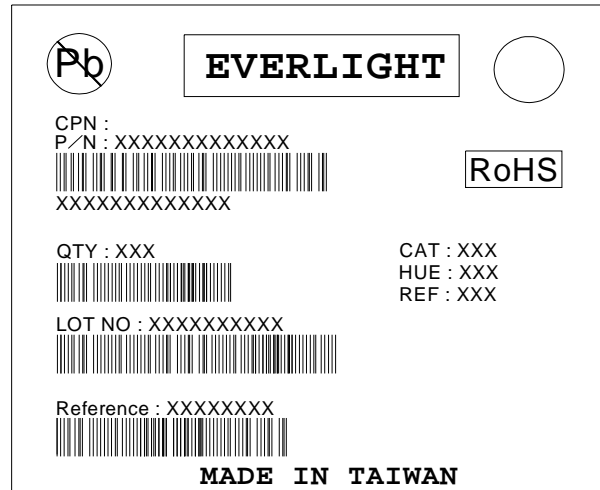

**Reel Dimensions**

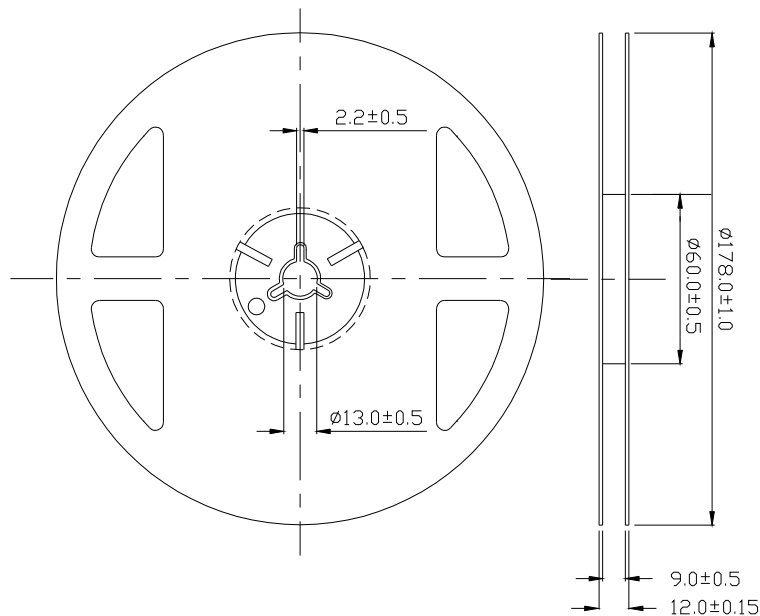

**Note:** The tolerances unless mentioned is  $\pm 0.1$ mm, Unit = mm

**Technical Data Sheet**  
**Power Top View LED**

**67-31A/B7C-AT1U2MZ3/2T**

**Carrier Tape Dimensions; Loaded Quantity 2000 pcs Per Reel**

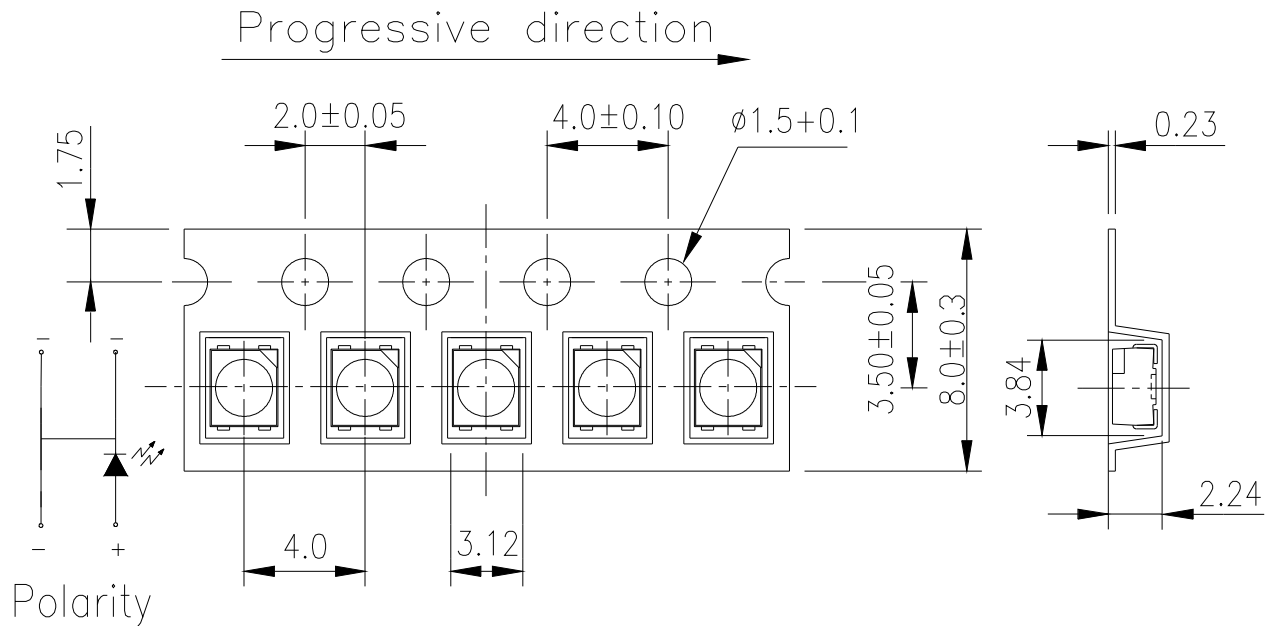

**Note:** Tolerances Unless Dimension  $\pm 0.1\text{mm}$  Unit = mm

**Moisture Resistant Packaging**

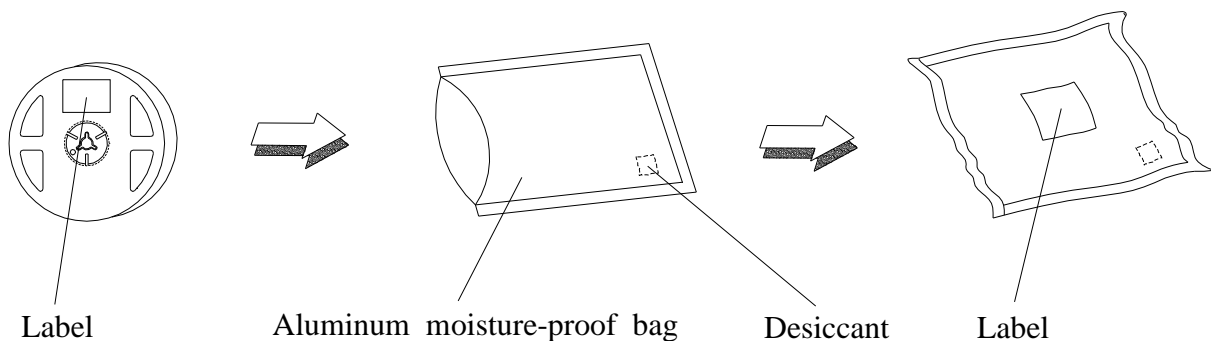

**Technical Data Sheet**  
**Power Top View LED**

**67-31A/B7C-AT1U2MZ3/2T**

**Reliability Test Items And Conditions**

The reliability of products shall be satisfied with items listed below.

Confidence level : 90%

LTPD : 10%

No.	Items	Test Condition	Test Hours/Cycles	Sample Size	Ac/Re
1	Reflow Soldering	Temp. : 260 ±5 Min. 5 sec.	6 Min.	22 PCS	0/1
2	Temperature Cycle	H : +100 15min 5 min L : -40 15min	300 Cycles	22 PCS.	0/1
3	Thermal Shock	H : +100 5min 10 sec L : -10 5min	300 Cycles	22 PCS.	0/1
4	High Temperature Storage	Temp. : 100	1000 Hrs.	22 PCS.	0/1
5	Low Temperature Storage	Temp. : -40	1000 Hrs.	22 PCS.	0/1
6	DC Operating Life	I <sub>F</sub> = 30 mA / 25	1000 Hrs.	22 PCS.	0/1
7	High Temperature / High Humidity	85 /85%RH	1000 Hrs.	22 PCS.	0/1



**Technical Data Sheet**  
**Power Top View LED**

**67-31A/B7C-AT1U2MZ3/2T**

**Precautions For Use**

1. Over-current-proof

Customer must apply resistors for protection, otherwise slight voltage shift will cause big current change ( Burn out will happen ).

2. Storage

- 2.1 Do not open moisture proof bag before the products are ready to use.
- 2.2 Before opening the package: The LEDs should be kept at 30 or less and 90%RH or less.
- 2.3 After opening the package: The LED's floor life are 168 hours under 30 or less and 60% RH or less.

If unused LEDs remain, it should be stored in moisture proof packages.

- 2.4 If the moisture absorbent material (silica gel) has faded away or the LEDs have exceeded the storage time, baking treatment should be performed using the following conditions.

Baking treatment : 60±5 for 24 hours.

3. Soldering Condition

3.1 Pb-free solder temperature profile

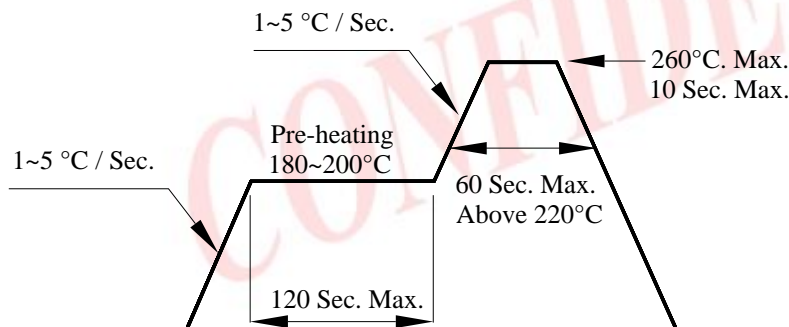

- 3.2 Reflow soldering should not be done more than two times.
- 3.3 When soldering, do not put stress on the LEDs during heating.
- 3.4 After soldering, do not warp the circuit board.

4. Soldering Iron

Each terminal is to go to the tip of soldering iron temperature less than 350 for 3 seconds within once in less than the soldering iron capacity 25W. Leave two seconds and more intervals, and do soldering of each terminal. Be careful because the damage of the product is often started at the time of the hand solder.

**Technical Data Sheet**  
**Power Top View LED**

**67-31A/B7C-AT1U2MZ3/2T**

5.Repairing

Repair should not be done after the LEDs have been soldered. When repairing is unavoidable, a double-head soldering iron should be used (as below figure). It should be confirmed beforehand whether the characteristics of the LEDs will or will not be damaged by repairing.

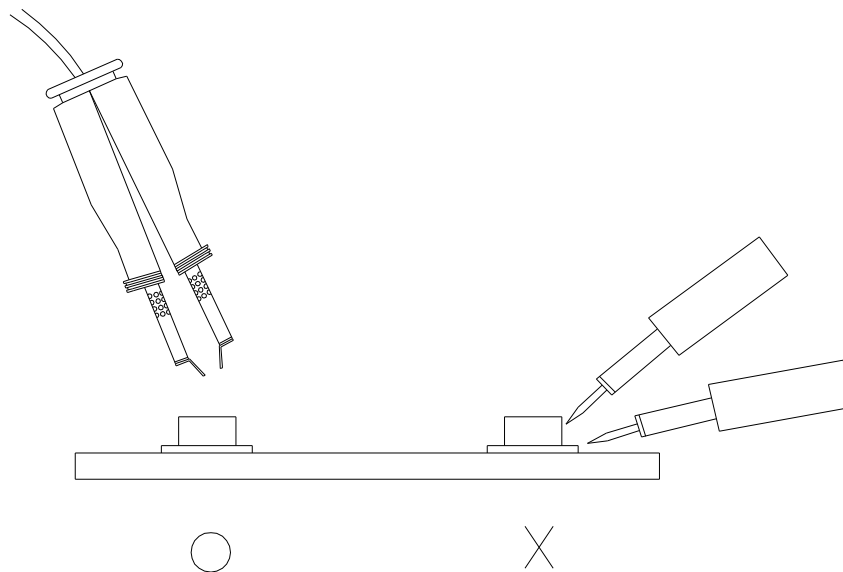

**EVERLIGHT ELECTRONICS CO., LTD.**  
Office: No 25, Lane 76, Sec 3, Chung Yang Rd,  
Tucheng, Taipei 236, Taiwan, R.O.C

Tel: 886-2-2267-2000, 2267-9936  
Fax: 886-2267-6244, 2267-6189, 2267-6306  
<http://www.everlight.com>