

PART No. 1437MD

for more information visit
www.hammfg.com

Data subject to change without notice

Isometric drawing Not to Scale

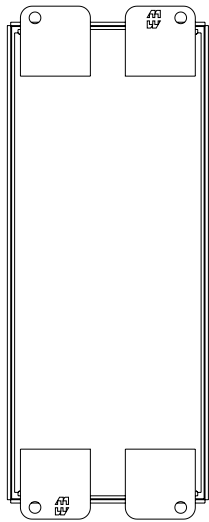

BACK VIEW

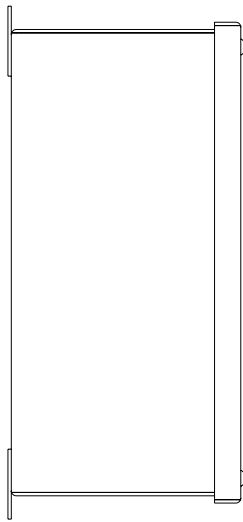

LEFT SIDE VIEW

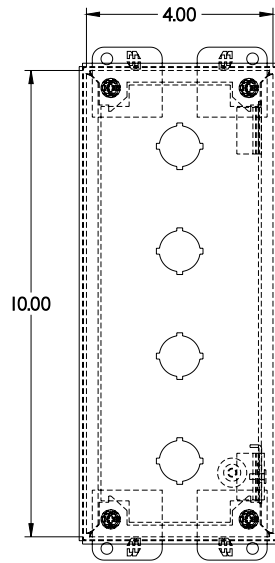

FRONT VIEW

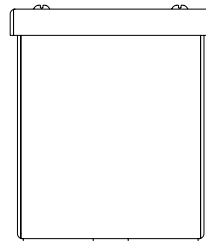

BOTTOM VIEW

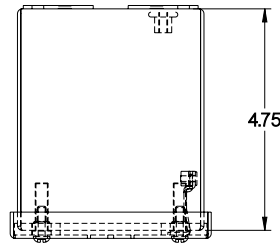

TOP VIEW

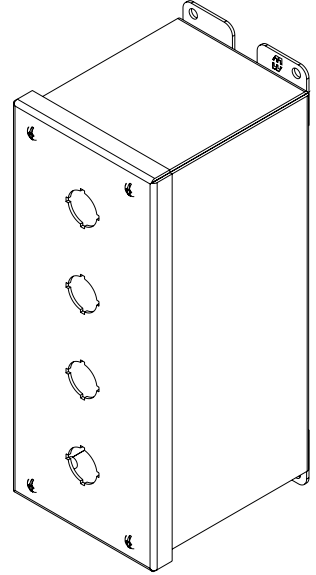

ISOMETRIC VIEW

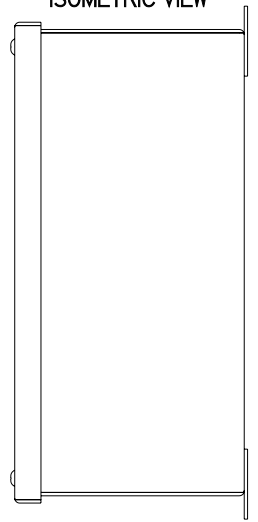

RIGHT SIDE VIEW