

PMD5001K

MOSFET driver

Rev. 01 — 3 November 2006

Product data sheet

1. Product profile

1.1 General description

PNP transistor and high-speed switching diode to protect the base-emitter junction in reverse direction in a SOT346 (SC-59A/TO-236) small Surface-Mounted Device (SMD) plastic package.

1.2 Features

- General-purpose transistor and high-speed switching diode as driver
- High-speed switching diode to protect the base-emitter junction
- Application-optimized pinout
- Internal connections to minimize layout effort
- Space-saving solution
- Reduces component count

1.3 Applications

- Power MOSFET driver

1.4 Quick reference data

Table 1. Quick reference data

Symbol	Parameter	Conditions	Min	Typ	Max	Unit
PNP transistor						
V_{CEO}	collector-emitter voltage	open base	-	-	-40	V
I_C	collector current		-	-	-0.1	A
I_{CM}	peak collector current	single pulse; $t_p \leq 1$ ms	-	-	-0.2	A
Diode						
I_F	forward current		-	-	0.2	A
V_F	forward voltage	$I_F = 200$ mA	[1]	-	1.1	V

[1] Pulse test: $t_p \leq 300$ μ s; $\delta \leq 0.02$.

2. Pinning information

Table 2. Pinning

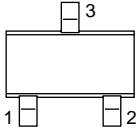
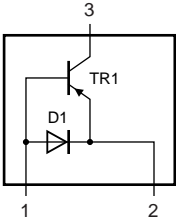
Pin	Description	Simplified outline	Symbol
1	base TR1, anode D1		
2	emitter TR1, cathode D1		
3	collector TR1		

006aaa656

3. Ordering information

Table 3. Ordering information

Type number	Package		
	Name	Description	Version
PMD5001K	SC-59A	plastic surface-mounted package; 3 leads	SOT346

4. Marking

Table 4. Marking codes

Type number	Marking code
PMD5001K	D4

5. Limiting values

Table 5. Limiting values

In accordance with the Absolute Maximum Rating System (IEC 60134).

Symbol	Parameter	Conditions	Min	Max	Unit	
PNP transistor						
V_{CBO}	collector-base voltage	open emitter	-	-40	V	
V_{CEO}	collector-emitter voltage	open base	-	-40	V	
I_C	collector current		-	-0.1	A	
I_{CM}	peak collector current	single pulse; $t_p \leq 1$ ms	-	-0.2	A	
I_B	base current		-	-0.1	A	
I_{BM}	peak base current	single pulse; $t_p \leq 1$ ms	-	-0.2	A	
P_{tot}	total power dissipation	$T_{amb} \leq 25$ °C	[1]	-	230	mW
			[2]	-	300	mW
			[3]	-	375	mW
Diode						
I_F	forward current		-	0.2	A	
I_{FRM}	repetitive peak forward current	$t_p \leq 1$ ms; $\delta = 0.25$	-	0.6	A	
I_{FSM}	non-repetitive peak forward current	square wave				
		$t_p \leq 1$ μ s	-	9	A	
		$t_p \leq 100$ μ s	-	3	A	
		$t_p \leq 10$ ms	-	1.7	A	
Device						
T_j	junction temperature		-	150	°C	
T_{amb}	ambient temperature		-65	+150	°C	
T_{stg}	storage temperature		-65	+150	°C	

[1] Device mounted on an FR4 Printed-Circuit Board (PCB), single-sided copper, tin-plated and standard footprint.

[2] Device mounted on an FR4 PCB, single-sided copper, tin-plated, mounting pad for collector 1 cm².

[3] Device mounted on a ceramic PCB, Al₂O₃, standard footprint.

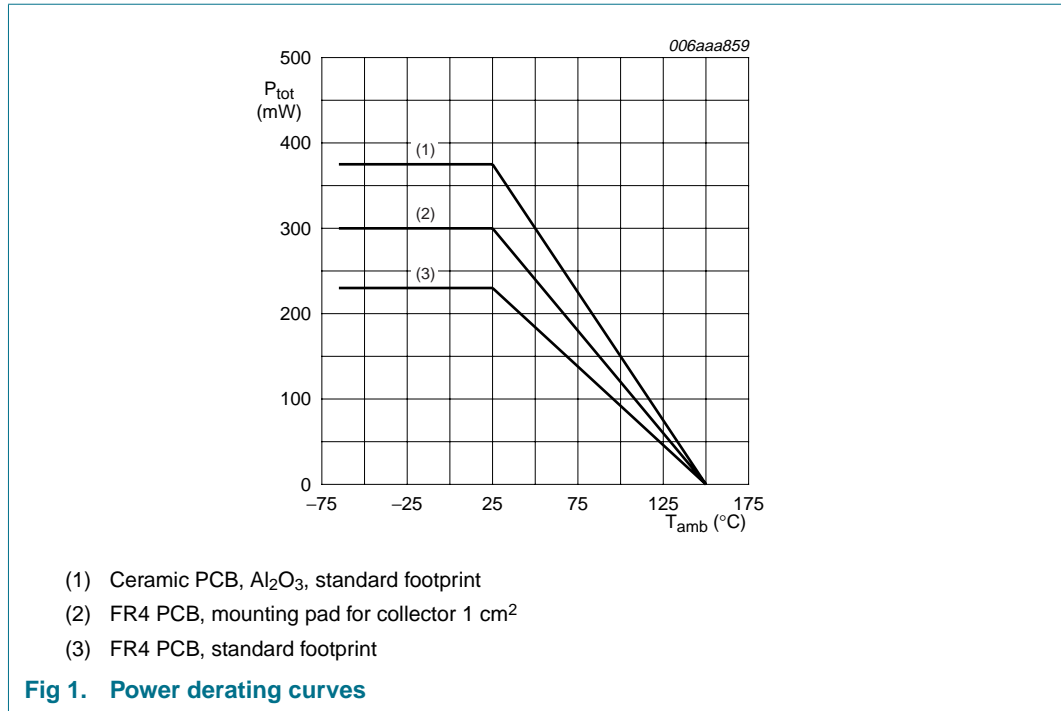

6. Thermal characteristics

Table 6. Thermal characteristics

Symbol	Parameter	Conditions	Min	Typ	Max	Unit	
PNP transistor							
R _{th(j-a)}	thermal resistance from junction to ambient	in free air	[1]	-	-	540	K/W
			[2]	-	-	415	K/W
			[3]	-	-	330	K/W

[1] Device mounted on an FR4 PCB, single-sided copper, tin-plated and standard footprint.

[2] Device mounted on an FR4 PCB, single-sided copper, tin-plated, mounting pad for collector 1 cm².

[3] Device mounted on a ceramic PCB, Al₂O₃, standard footprint.

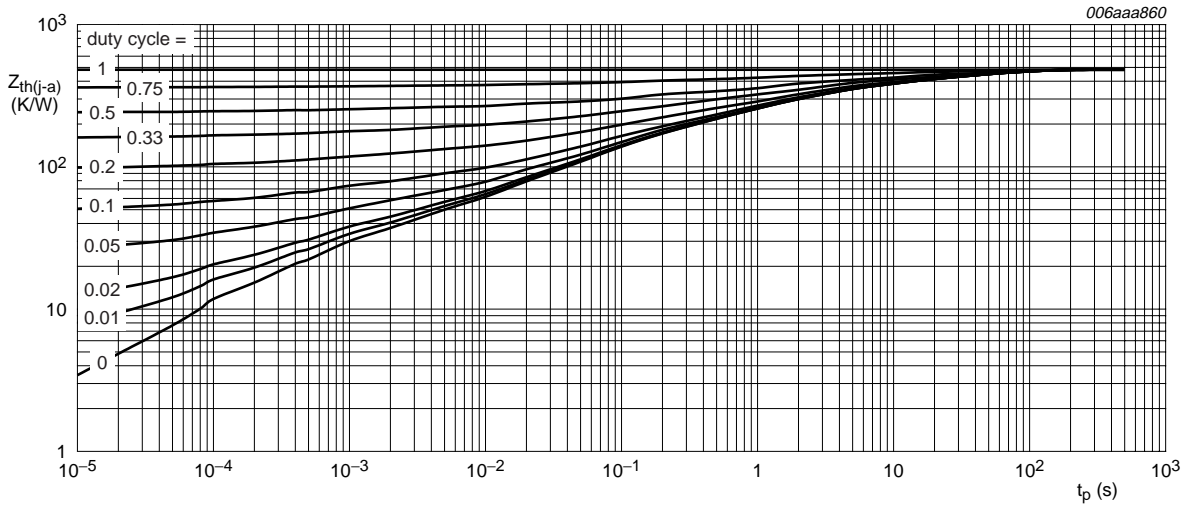

FR4 PCB, standard footprint

Fig 2. Transient thermal impedance from junction to ambient as a function of pulse duration; typical values

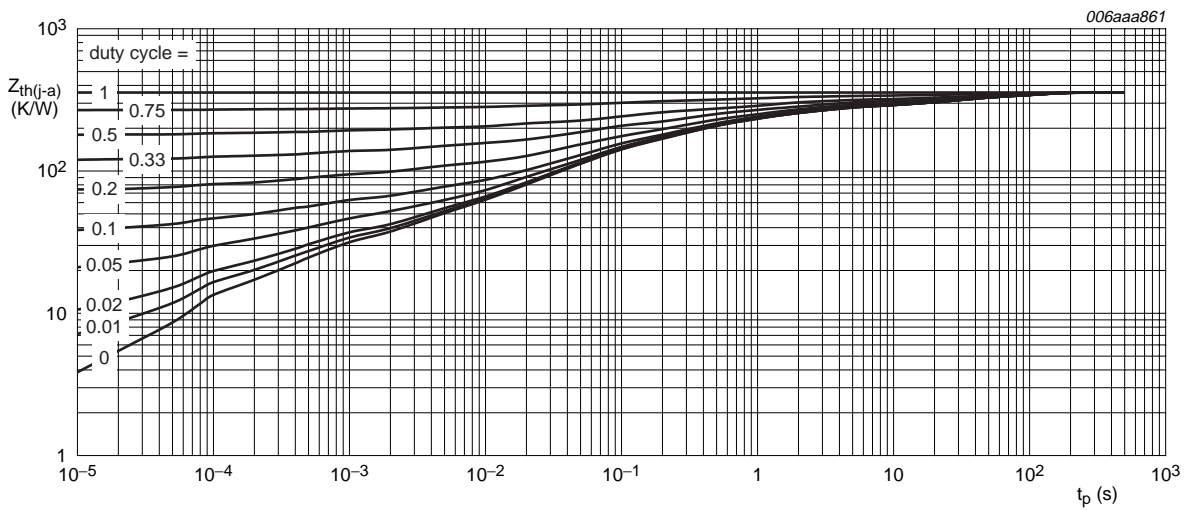

FR4 PCB, mounting pad for collector 1 cm²

Fig 3. Transient thermal impedance from junction to ambient as a function of pulse duration; typical values

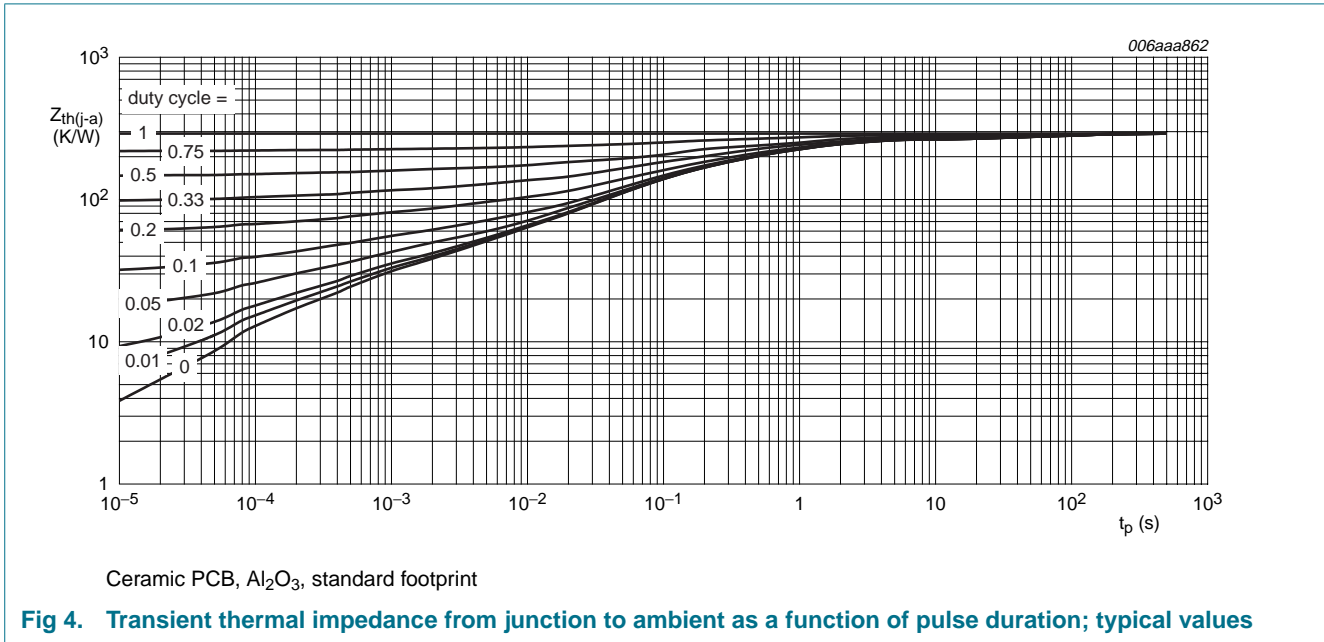

7. Characteristics

Table 7. Characteristics

Symbol	Parameter	Conditions	Min	Typ	Max	Unit
PNP transistor						
I_{CBO}	collector-base cut-off current	$V_{CB} = -40\text{ V}; I_E = 0\text{ A}$	-	-	-15	nA
		$V_{CB} = -40\text{ V}; I_E = 0\text{ A}; T_j = 150\text{ °C}$	-	-	-5	μA
h_{FE}	DC current gain	$V_{CE} = -5\text{ V}; I_C = -1\text{ mA}$	200	290	450	
		$V_{CE} = -5\text{ V}; I_C = -100\text{ mA}$	95	150	-	
		$V_{CE} = -5\text{ V}; I_C = -200\text{ mA}$	24	55	-	
V_{CEsat}	collector-emitter saturation voltage	$I_C = -10\text{ mA}; I_B = -0.5\text{ mA}$	-	-90	-250	mV
		$I_C = -100\text{ mA}; I_B = -5\text{ mA}$	-	-200	-400	mV
		$I_C = -200\text{ mA}; I_B = -20\text{ mA}$	-	-350	-500	mV
V_{BEsat}	base-emitter saturation voltage	$I_C = -10\text{ mA}; I_B = -0.5\text{ mA}$	-	-0.7	-	V
		$I_C = -100\text{ mA}; I_B = -5\text{ mA}$	-	-0.85	-	V
		$I_C = -200\text{ mA}; I_B = -20\text{ mA}$	-	-1	-1.2	V
V_{BE}	base-emitter voltage	$V_{CE} = -5\text{ V}; I_C = -2\text{ mA}$	-	-650	-	mV
Diode						
V_F	forward voltage	$I_F = 200\text{ mA}$	[1]	-	1.1	V
Device						
t_d	delay time	$I_C = -0.05\text{ A}; I_B = -2.5\text{ mA}$	-	8	-	ns
t_r	rise time		-	56	-	ns
t_{on}	turn-on time		-	64	-	ns
t_s	storage time		-	588	-	ns
t_f	fall time		-	216	-	ns
t_{off}	turn-off time		-	804	-	ns
Device with optional capacitor C1						
t_d	delay time	$I_C = -0.05\text{ A}; I_B = -2.5\text{ mA}; C1 = 1\text{ nF}$	-	4	-	ns
t_r	rise time		-	6	-	ns
t_{on}	turn-on time		-	10	-	ns
t_s	storage time		-	108	-	ns
t_f	fall time		-	57	-	ns
t_{off}	turn-off time		-	165	-	ns

[1] Pulse test: $t_p \leq 300\text{ }\mu\text{s}; \delta \leq 0.02$.

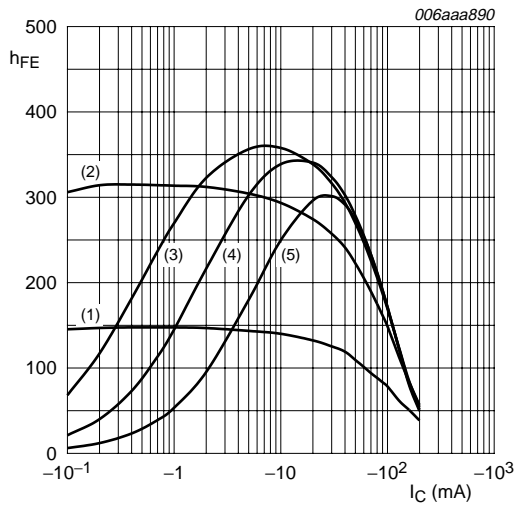

$V_{CE} = -5 V$
 (1) $T_{amb} = -55^\circ C$
 (2) $T_{amb} = 25^\circ C$
 (3) $T_{amb} = 100^\circ C$
 (4) $T_{amb} = 125^\circ C$
 (5) $T_{amb} = 150^\circ C$

Fig 5. DC current gain as a function of collector current; typical values

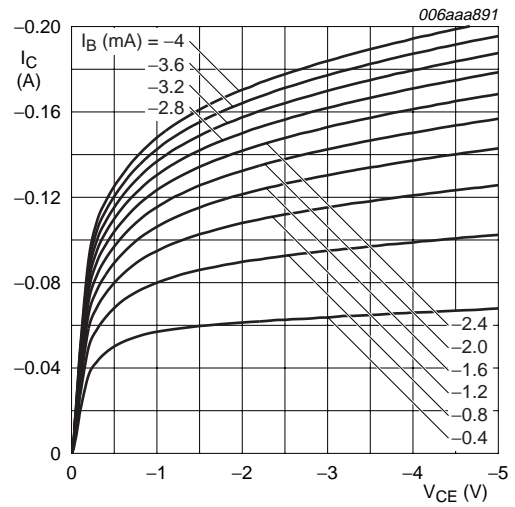

$T_{amb} = 25^\circ C$

Fig 6. Collector current as a function of collector-emitter voltage; typical values

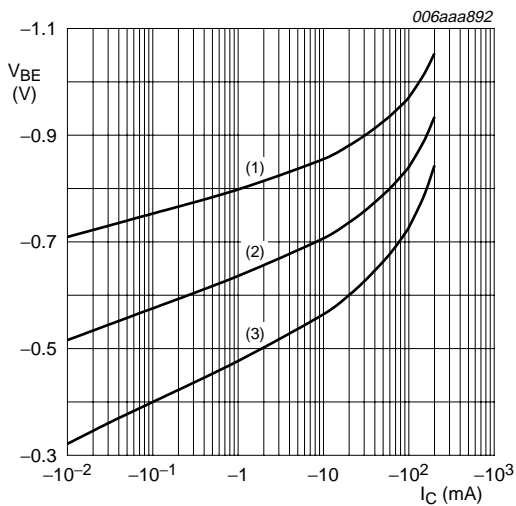

$V_{CE} = -5 V$
 (1) $T_{amb} = -55^\circ C$
 (2) $T_{amb} = 25^\circ C$
 (3) $T_{amb} = 100^\circ C$

Fig 7. Base-emitter voltage as a function of collector current; typical values

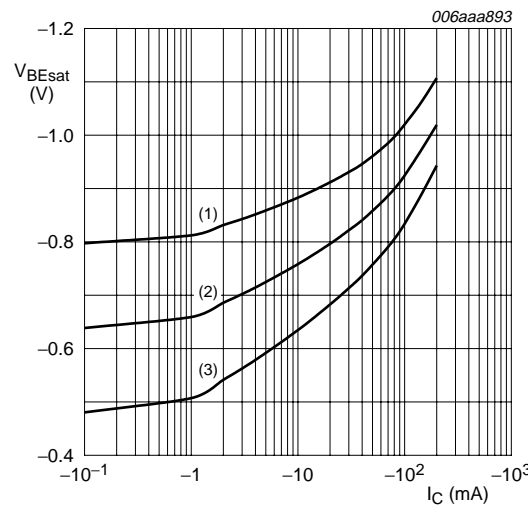

$I_C/I_B = 20$
 (1) $T_{amb} = -55^\circ C$
 (2) $T_{amb} = 25^\circ C$
 (3) $T_{amb} = 100^\circ C$

Fig 8. Base-emitter saturation voltage as a function of collector current; typical values

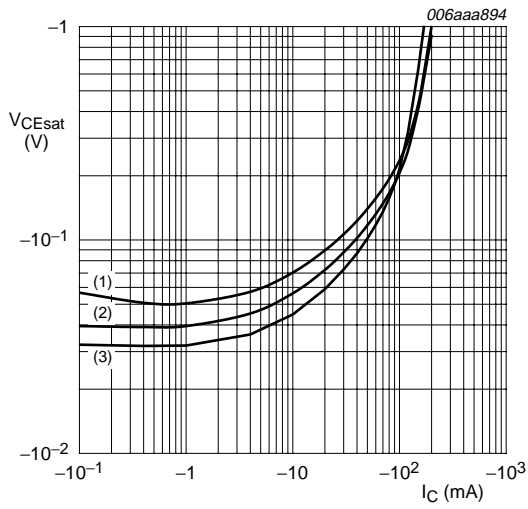

$I_C/I_B = 20$
 (1) $T_{amb} = 100\text{ }^\circ\text{C}$
 (2) $T_{amb} = 25\text{ }^\circ\text{C}$
 (3) $T_{amb} = -55\text{ }^\circ\text{C}$

Fig 9. Collector-emitter saturation voltage as a function of collector current; typical values

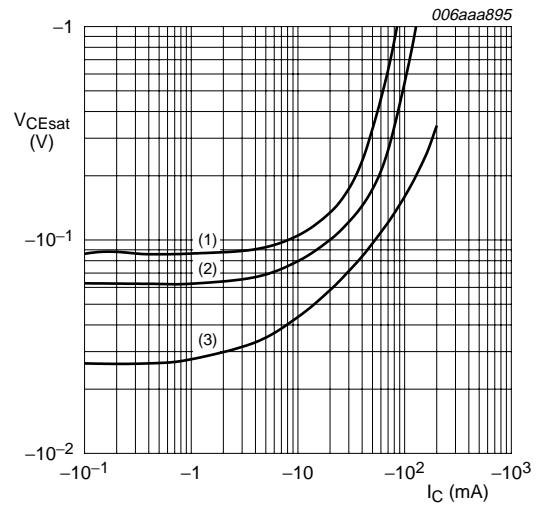

$T_{amb} = 25\text{ }^\circ\text{C}$
 (1) $I_C/I_B = 100$
 (2) $I_C/I_B = 50$
 (3) $I_C/I_B = 10$

Fig 10. Collector-emitter saturation voltage as a function of collector current; typical values

8. Test information

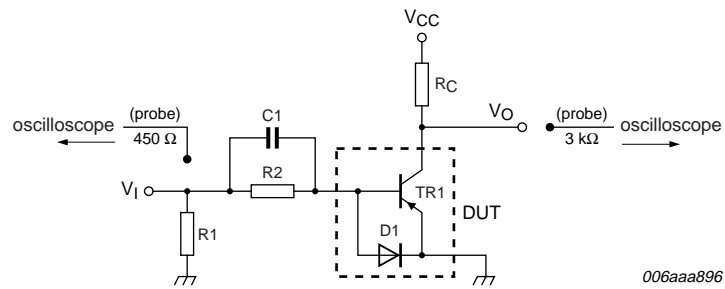

$I_C = -0.05\text{ A}$; $I_B = -2.5\text{ mA}$; $R_1 = 50\text{ }\Omega$; $R_2 = 3\text{ k}\Omega$; $R_C = 180\text{ }\Omega$; $C_1 = 1\text{ nF}$

Fig 11. Test circuit for switching times

9. Package outline

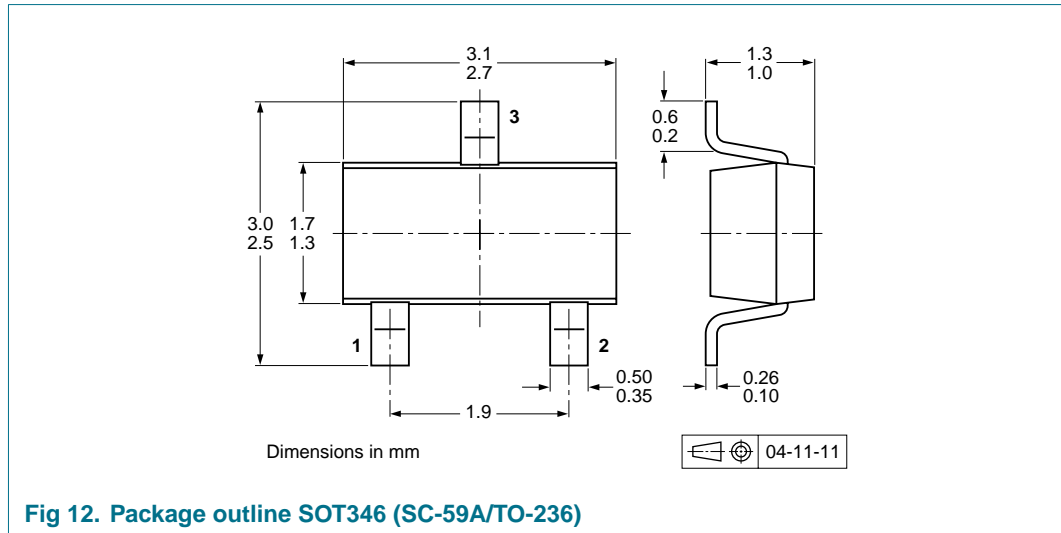

10. Packing information

Table 8. Packing methods

The indicated -xxx are the last three digits of the 12NC ordering code.^[1]

Type number	Package	Description	Packing quantity	
			3000	10000
PMD5001K	SOT346	4 mm pitch, 8 mm tape and reel	-115	-135

[1] For further information and the availability of packing methods, see [Section 15](#).

12. Mounting

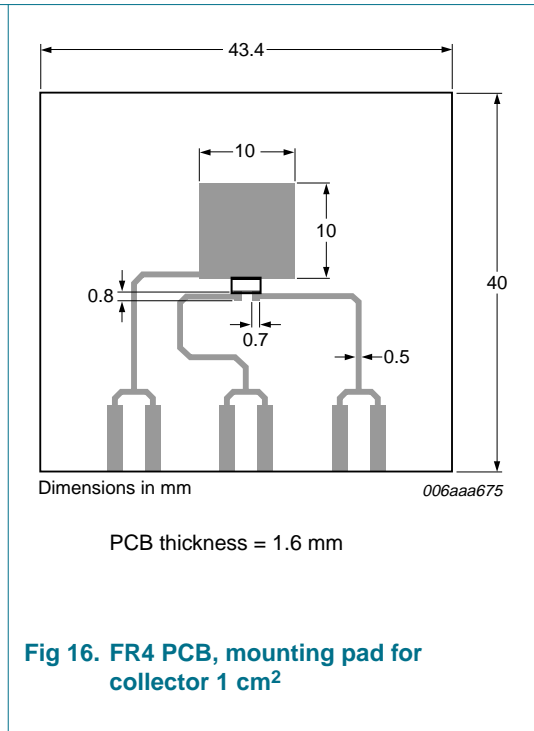
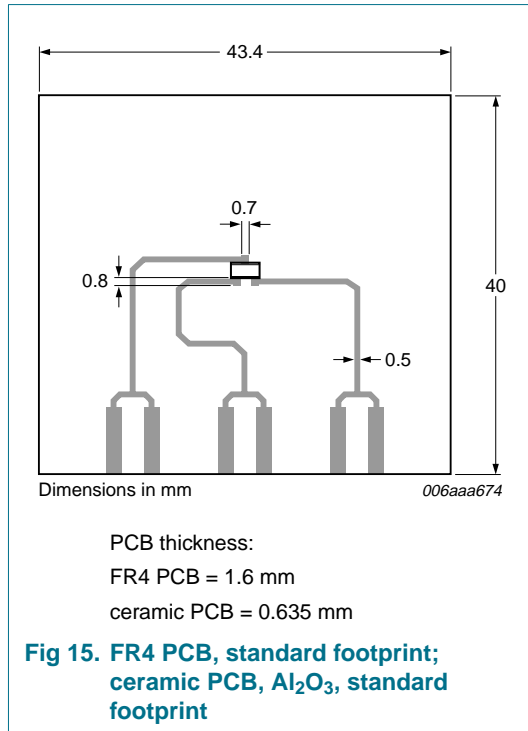

13. Revision history

Table 9. Revision history

Document ID	Release date	Data sheet status	Change notice	Supersedes
PMD5001K_1	20061103	Product data sheet	-	-

14. Legal information

14.1 Data sheet status

Document status ^{[1][2]}	Product status ^[3]	Definition
Objective [short] data sheet	Development	This document contains data from the objective specification for product development.
Preliminary [short] data sheet	Qualification	This document contains data from the preliminary specification.
Product [short] data sheet	Production	This document contains the product specification.

[1] Please consult the most recently issued document before initiating or completing a design.

[2] The term 'short data sheet' is explained in section "Definitions".

[3] The product status of device(s) described in this document may have changed since this document was published and may differ in case of multiple devices. The latest product status information is available on the Internet at URL <http://www.nxp.com>.

14.2 Definitions

Draft — The document is a draft version only. The content is still under internal review and subject to formal approval, which may result in modifications or additions. NXP Semiconductors does not give any representations or warranties as to the accuracy or completeness of information included herein and shall have no liability for the consequences of use of such information.

Short data sheet — A short data sheet is an extract from a full data sheet with the same product type number(s) and title. A short data sheet is intended for quick reference only and should not be relied upon to contain detailed and full information. For detailed and full information see the relevant full data sheet, which is available on request via the local NXP Semiconductors sales office. In case of any inconsistency or conflict with the short data sheet, the full data sheet shall prevail.

14.3 Disclaimers

General — Information in this document is believed to be accurate and reliable. However, NXP Semiconductors does not give any representations or warranties, expressed or implied, as to the accuracy or completeness of such information and shall have no liability for the consequences of use of such information.

Right to make changes — NXP Semiconductors reserves the right to make changes to information published in this document, including without limitation specifications and product descriptions, at any time and without notice. This document supersedes and replaces all information supplied prior to the publication hereof.

Suitability for use — NXP Semiconductors products are not designed, authorized or warranted to be suitable for use in medical, military, aircraft, space or life support equipment, nor in applications where failure or

malfunction of a NXP Semiconductors product can reasonably be expected to result in personal injury, death or severe property or environmental damage. NXP Semiconductors accepts no liability for inclusion and/or use of NXP Semiconductors products in such equipment or applications and therefore such inclusion and/or use is at the customer's own risk.

Applications — Applications that are described herein for any of these products are for illustrative purposes only. NXP Semiconductors makes no representation or warranty that such applications will be suitable for the specified use without further testing or modification.

Limiting values — Stress above one or more limiting values (as defined in the Absolute Maximum Ratings System of IEC 60134) may cause permanent damage to the device. Limiting values are stress ratings only and operation of the device at these or any other conditions above those given in the Characteristics sections of this document is not implied. Exposure to limiting values for extended periods may affect device reliability.

Terms and conditions of sale — NXP Semiconductors products are sold subject to the general terms and conditions of commercial sale, as published at <http://www.nxp.com/profile/terms>, including those pertaining to warranty, intellectual property rights infringement and limitation of liability, unless explicitly otherwise agreed to in writing by NXP Semiconductors. In case of any inconsistency or conflict between information in this document and such terms and conditions, the latter will prevail.

No offer to sell or license — Nothing in this document may be interpreted or construed as an offer to sell products that is open for acceptance or the grant, conveyance or implication of any license under any copyrights, patents or other industrial or intellectual property rights.

14.4 Trademarks

Notice: All referenced brands, product names, service names and trademarks are the property of their respective owners.

15. Contact information

For additional information, please visit: <http://www.nxp.com>

For sales office addresses, send an email to: salesaddresses@nxp.com

16. Contents

1 Product profile 1

1.1 General description 1

1.2 Features 1

1.3 Applications 1

1.4 Quick reference data 1

2 Pinning information 2

3 Ordering information 2

4 Marking 2

5 Limiting values 3

6 Thermal characteristics 4

7 Characteristics 7

8 Test information 9

9 Package outline 10

10 Packing information 10

11 Soldering 11

12 Mounting 12

13 Revision history 13

14 Legal information 14

14.1 Data sheet status 14

14.2 Definitions 14

14.3 Disclaimers 14

14.4 Trademarks 14

15 Contact information 14

16 Contents 15

Please be aware that important notices concerning this document and the product(s) described herein, have been included in section 'Legal information'.



© NXP B.V. 2006.

All rights reserved.

For more information, please visit: <http://www.nxp.com>

For sales office addresses, please send an email to: salesaddresses@nxp.com

Date of release: 3 November 2006

Document identifier: PMD5001K_1