

PART NUMBER

C DSM -S288

MATERIALS (INSULATOR / CONTACT)

- E = PBT/PHOSPHOR BRONZE**
OPERATING TEMP: -65°C TO +125°C
PROCESSING TEMP: WAVE / MANUAL ONLY
- R = PPS/PHOSPHOR BRONZE**
OPERATING TEMP: -65°C TO +125°C
PROCESSING TEMP: 260°C FOR 120 SECS MAX
- G = PA9T/PHOSPHOR BRONZE**
OPERATING TEMP: -65°C TO +125°C
PROCESSING TEMP: 260°C FOR 20 SECS MAX
- H = PBT/BERYLLIUM COPPER**
OPERATING TEMP: -65°C TO +125°C
PROCESSING TEMP: WAVE / MANUAL ONLY
- A = PPS/BERYLLIUM COPPER**
OPERATING TEMP: -65°C TO +150°C
PROCESSING TEMP: 260°C FOR 120 SECS MAX
- J = PA9T/BERYLLIUM COPPER**
OPERATING TEMP: -65°C TO +150°C
PROCESSING TEMP: 260°C FOR 20 SECS MAX
(CONSULT FACTORY FOR OTHER MATERIALS)

- MOUNTING STYLE**
- H = .125" DIA. CLEARANCE HOLES (PAGE 1)
 - I = #4-40 THREADED INSERT (PAGE 2)
 - S = .125" DIA. SIDE MOUNTING (PAGE 2)
 - N = NO MOUNTING EARS (PAGE 2)

**NUMBER OF POSITIONS
(CONTACTS PER ROW)**

PLATING

- ALL PLATINGS ARE LEAD FREE AND HAVE .000050" MIN NICKEL UNDERPLATE
- | | |
|---|--------------------------|
| CONTACT SURFACE | TERMINATION |
| G = .000010" GOLD | .000005" GOLD |
| Y = .000030" GOLD | .000005" GOLD |
| B = .000010" GOLD | .000100" PURE TIN, MATTE |
| C = .000030" GOLD | .000100" PURE TIN, MATTE |
| **E = .000100" PURE TIN, MATTE, OVERALL | |
| S = .000010" GOLD OVERALL | |
| M = .000030" GOLD | .000010" GOLD OVERALL |
- ** OVERALL PURE TIN ONLY AVAILABLE ON MATERIAL CODES E, R AND G

REVISIONS				
REV.	ECO. NO	DESCRIPTION	DATE	BY
A	2879	INITIAL RELEASE, OBSOLETE DWG 5704 & 5705	12/27/2013	JH

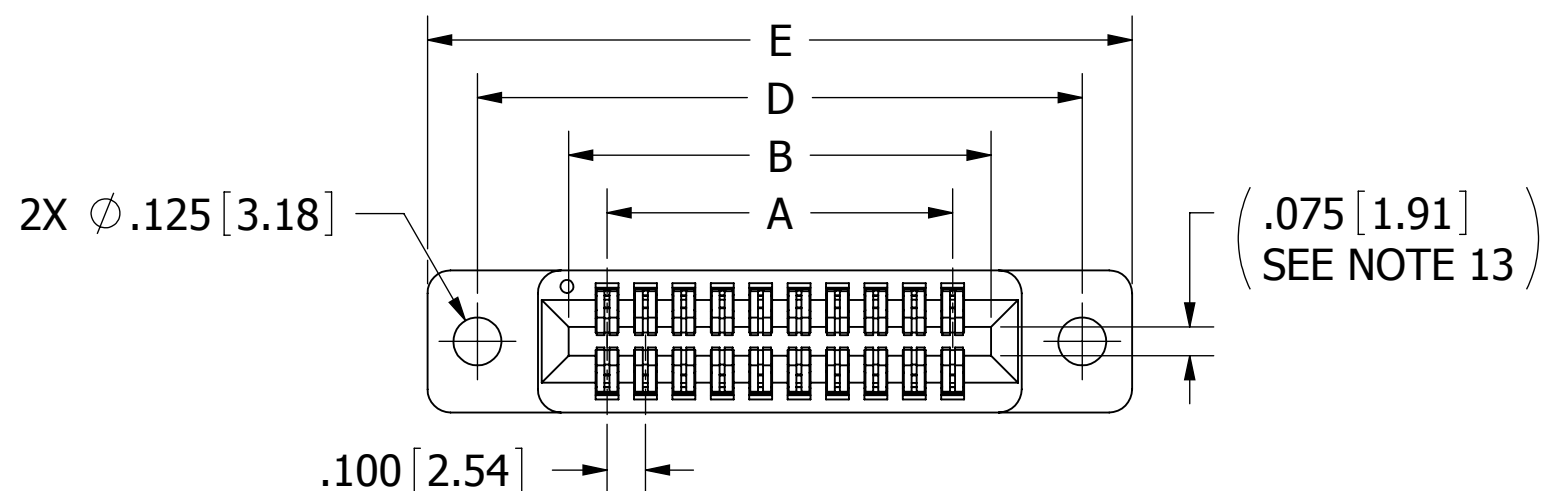

CONTACT MARKINGS
1 3 5 ... 95 97 99
2 4 6 ... 96 98 100

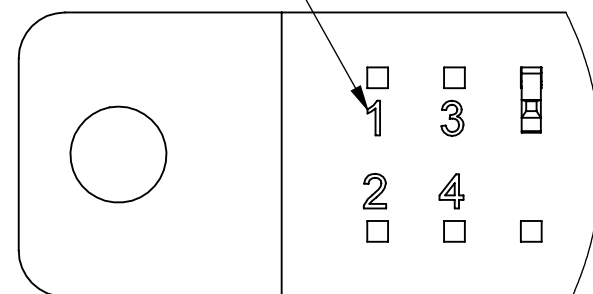

**CONTACT ID:
SCALE: 4:1
(CONTACT PINS OMITTED
FOR CLARITY)**

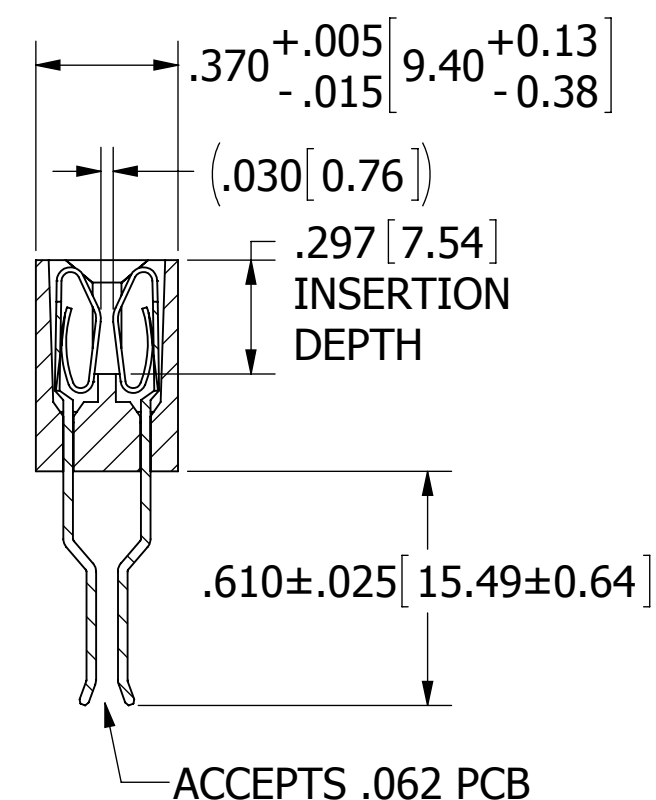
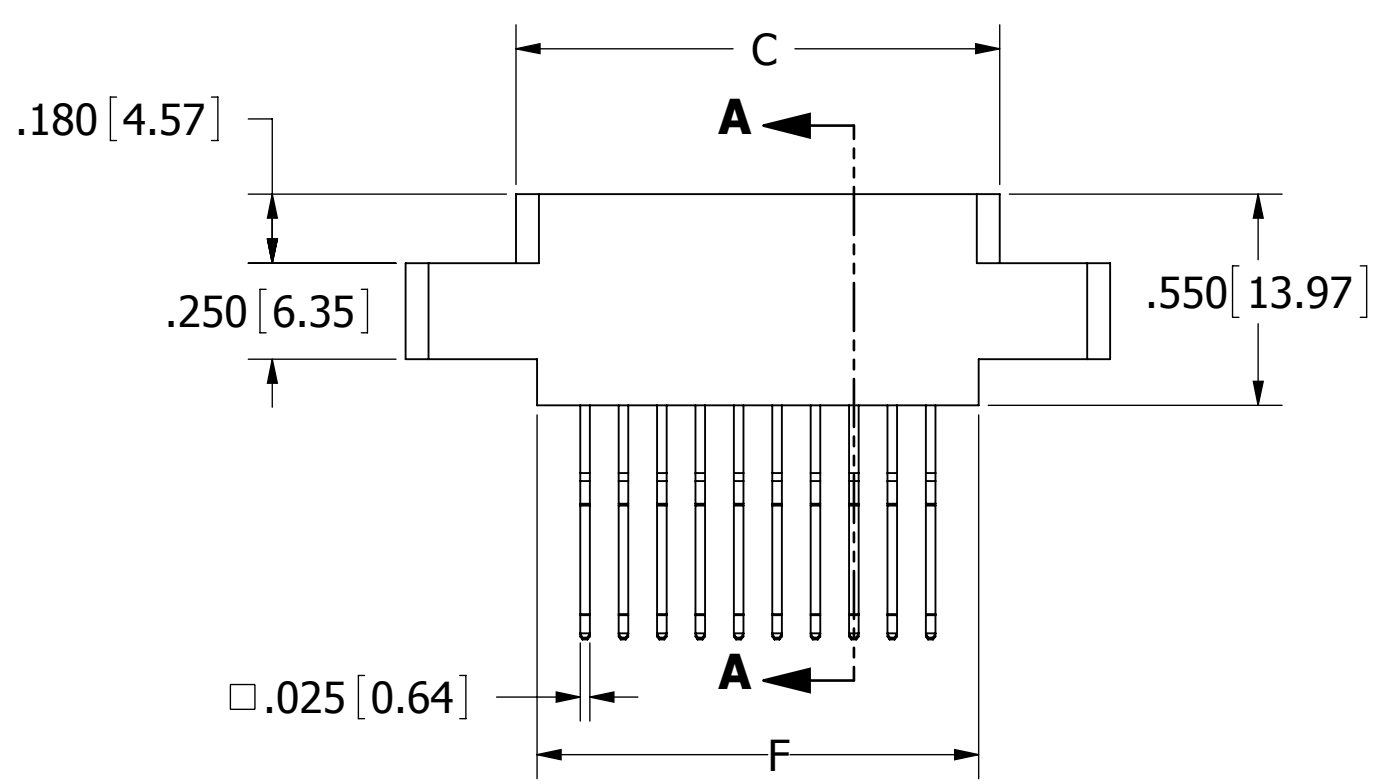

- NOTES:**
1. INSULATOR MATERIAL: SEE PART NUMBER CODING.
 2. CONTACT MATERIAL: SEE PART NUMBER CODING.
 3. PLATING: SEE PART NUMBER CODING.
 4. OPERATING TEMPERATURE: SEE PART NUMBER CODING.
 5. PROCESSING TEMP: SEE PART NUMBER CODING.
 6. UL FLAMMABILITY RATING: 94V-0
 7. OPERATING VOLTAGE: 700 VAC MINIMUM AT SEA LEVEL
 8. CURRENT RATING: 3 AMP
 9. CONTACT RESISTANCE: 30 MILLI OHMS MAX
 10. INSULATION RESISTANCE: 5000 MEGA OHMS
 11. DURABILITY: 500 CYCLES MIN
 12. CONNECTOR IDENTIFICATION: THE PART SHALL BE MARKED WITH A PART NUMBER AND LOT CODE
 13. BOARD THICKNESS ACCOMMODATED: .062 ± .008 [1.57 ± 0.20]
 14. INSERTION FORCE: 8 OZ MAX PER CONTACT PAIR WHEN USING A .062 [1.57] TEST BLADE
 15. WITHDRAWAL FORCE: 1 OZ MIN PER CONTACT PAIR USING .062 [1.57] PCB
 16. MODIFICATION: CARD EXTENDER BEND FOR .062 [1.57] PCB.



CUSTOMER COPY

UNLESS OTHERWISE SPECIFIED: DIMENSIONS ARE IN INCHES [MM]		DRAWN	DATE	NAME		
			12/27/13	JH		
TOLERANCES: ANGULAR: ± 1° DECIMALS .XX = ± .02 [.5] .XXX = ± .005 [1.3] .XXXX = ± .0005 [0.13]					TITLE EDGE CARD, .100 CC, HP	
THE INFORMATION HEREIN CONTAINS PROPRIETARY INFORMATION OF SULLINS ELECTRONICS AND IS NOT TO BE REPRODUCED, USED OR DISCLOSED TO OTHERS FOR ANY PURPOSE EXCEPT AS SPECIFICALLY AUTHORIZED IN WRITING BY AN OFFICER OF SULLINS ELECTRONICS.					PART NUMBER C DSM -S288	
SIZE	CAGE CODE	DWG. NO.	REV			
C	54453	C12324	A			
SCALE: 2:1		SHEET 1 OF 2				

PART NUMBER	NO. OF POSITIONS	A±.008[0.20]		B±.008[0.20]		C±.015[0.38]		D±.010[0.25]		E±.020[0.51]		F±.015[0.38]	
		INCH	MM	INCH	MM	INCH	MM	INCH	MM	INCH	MM	INCH	MM
C06DSM -S288	6	0.500	12.70	0.700	17.78	0.860	21.84	1.175	29.85	1.435	36.45	0.750	19.05
C07DSM -S288	7	0.600	15.24	0.800	20.32	0.960	24.38	1.275	32.39	1.535	38.99	0.850	21.59
C08DSM -S288	8	0.700	17.78	0.900	22.86	1.060	26.92	1.375	34.93	1.635	41.53	0.950	24.13
C10DSM -S288	10	0.900	22.86	1.100	27.94	1.260	32.00	1.575	40.01	1.835	46.61	1.150	29.21
C12DSM -S288	12	1.100	27.94	1.300	33.02	1.460	37.08	1.775	45.09	2.035	51.69	1.350	34.29
C13DSM -S288	13	1.200	30.48	1.400	35.56	1.560	39.62	1.875	47.63	2.135	54.23	1.450	36.83
C15DSM -S288	15	1.400	35.56	1.600	40.64	1.760	44.70	2.075	52.71	2.335	59.31	1.650	41.91
C17DSM -S288	17	1.600	40.64	1.800	45.72	1.960	49.78	2.275	57.79	2.535	64.39	1.850	46.99
C18DSM -S288	18	1.700	43.18	1.900	48.26	2.060	52.32	2.375	60.33	2.635	66.93	1.950	49.53
C20DSM -S288	20	1.900	48.26	2.100	53.34	2.260	57.40	2.575	65.41	2.835	72.01	2.150	54.61
C22DSM -S288	22	2.100	53.34	2.300	58.42	2.460	62.48	2.775	70.49	3.035	77.09	2.350	59.69
C24DSM -S288	24	2.300	58.42	2.500	63.50	2.660	67.56	2.975	75.57	3.235	82.17	2.550	64.77
C25DSM -S288	25	2.400	60.96	2.600	66.04	2.760	70.10	3.075	78.11	3.335	84.71	2.650	67.31
C28DSM -S288	28	2.700	68.58	2.900	73.66	3.060	77.72	3.375	85.73	3.635	92.33	2.950	74.93
C29DSM -S288	29	2.800	71.12	3.000	76.20	3.160	80.26	3.475	88.27	3.735	94.87	3.050	77.47
C30DSM -S288	30	2.900	73.66	3.100	78.74	3.260	82.80	3.575	90.81	3.835	97.41	3.150	80.01
C31DSM -S288	31	3.000	76.20	3.200	81.28	3.360	85.34	3.675	93.35	3.935	99.95	3.250	82.55
C35DSM -S288	35	3.400	86.36	3.600	91.44	3.760	95.50	4.075	103.51	4.335	110.11	3.650	92.71
C36DSM -S288	36	3.500	88.90	3.700	93.98	3.860	98.04	4.175	106.05	4.435	112.65	3.750	95.25
C40DSM -S288	40	3.900	99.06	4.100	104.14	4.260	108.20	4.575	116.21	4.835	122.81	4.150	105.41
C43DSM -S288	43	4.200	106.68	4.400	111.76	4.560	115.82	4.875	123.83	5.135	130.43	4.450	113.03
C44DSM -S288	44	4.300	109.22	4.500	114.30	4.660	118.36	4.975	126.37	5.235	132.97	4.550	115.57
C49DSM -S288	49	4.800	121.92	5.000	127.00	5.160	131.06	5.475	139.07	5.735	145.67	5.050	128.27
C50DSM -S288	50	4.900	124.46	5.100	129.54	5.260	133.60	5.575	141.61	5.835	148.21	5.150	130.81
C55DSM -S288	55	5.400	137.16	5.600	142.24	5.760	146.30	6.075	154.31	6.335	160.91	5.650	143.51
C60DSM -S288	60	5.900	149.86	6.100	154.94	6.260	159.00	6.575	167.01	6.835	173.61	6.150	156.21
C61DSM -S288	61	6.000	152.40	6.200	157.48	6.360	161.54	6.675	169.55	6.935	176.15	6.250	158.75
C65DSM -S288	65	6.400	162.56	6.600	167.64	6.760	171.70	7.075	179.71	7.335	186.31	6.650	168.91
C70DSM -S288	70	6.900	175.26	7.100	180.34	7.260	184.40	7.575	192.41	7.835	199.01	7.150	181.61
C80DSM -S288	80	7.900	200.66	8.100	205.74	8.260	209.80	8.575	217.81	8.835	224.41	8.150	207.01
C90DSM -S288	90	8.900	226.06	9.100	231.14	9.260	235.20	9.575	243.21	9.835	249.81	9.150	232.41
C100DSM -S288	100	9.900	251.46	10.100	256.54	10.260	260.60	10.575	268.61	10.835	275.21	10.150	257.81

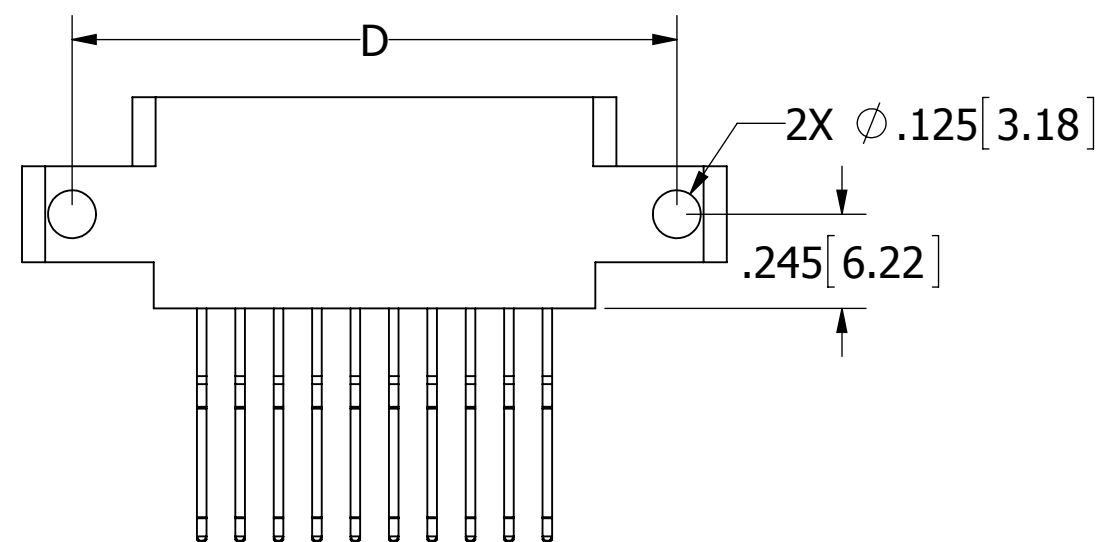
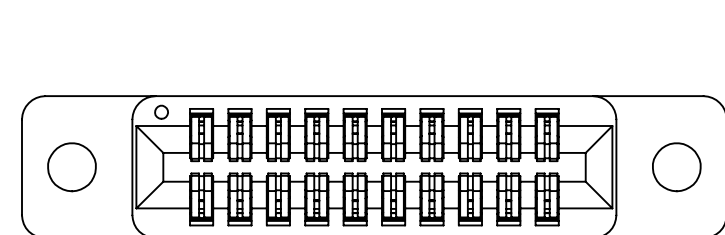

--C_DSMS-S288

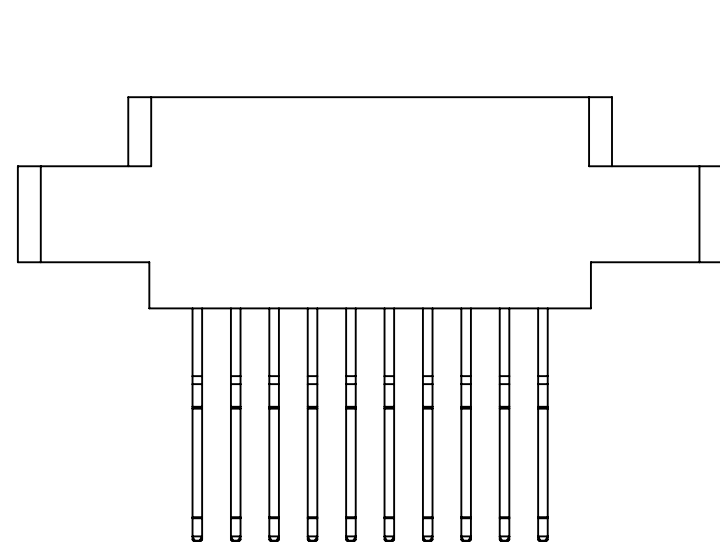
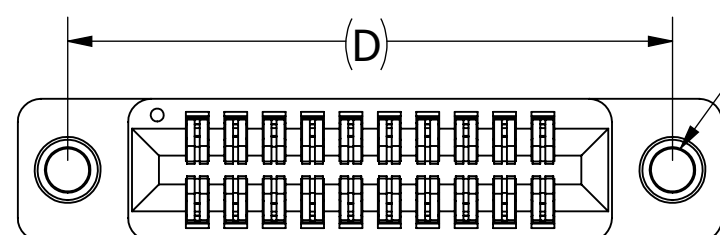

--C_DSMI-S288

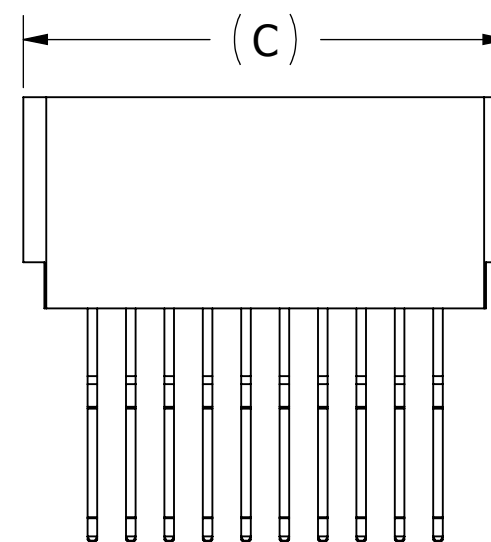
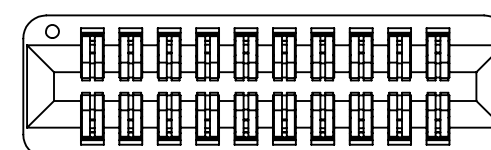

--C_DSMN-S288

2X #4-40
THREADED
INSERT

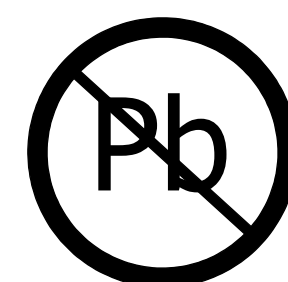

RoHS COMPLIANT

UNLESS OTHERWISE SPECIFIED:
DIMENSIONS ARE IN INCHES [MM]

TOLERANCES:

ANGULAR: ± 1°

DECIMALS

.XX=± .02 [.5]

.XXX=± .005 [.13]

.XXXX=± .0005 [.013]

DRAWN	DATE	NAME
	12/27/13	JH

THE INFORMATION HEREIN CONTAINS
PROPRIETARY INFORMATION OF
SULLINS ELECTRONICS AND IS NOT
TO BE REPRODUCED, USED OR
DISCLOSED TO OTHERS FOR ANY
PURPOSE EXCEPT AS SPECIFICALLY
AUTHORIZED IN WRITING BY AN
OFFICER OF SULLINS ELECTRONICS.

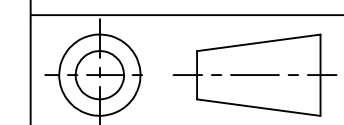

TITLE
EDGECARD, .100 CC, HP

PART NUMBER
--C_DSMS-S288

SIZE	CAGE CODE	DWG. NO.	REV
C	54453	C12324	A

SCALE: 2:1 SHEET 2 OF 2

CUSTOMER COPY