

Preliminary

Messrs. _____

Shock Sensor Specification

Part No. : PSCE242K-R090C

RoHS Compliant

Halogen-Free Compliant

16. Dec. 2010

Approved by _____ Kazuki Shimizu _____

Checked by _____ Yasuhiro Nakai _____

Issued by _____ Akira Oikawa _____

KYOCERA CORPORATION

Preliminary**1.Scope**

This specification shall cover the characteristics of the shock sensor.

2.Kyocera's Type Name**PSCE242K-R090C****3.Customer's Type Name****4.Electrical Characteristics**

Items	Specifications
4-1 Primary Axis Inclined Angle	25 ± 3 degree
4-2 Capacitance	$315\text{pF} \pm 30\%$, at 1Vrms, 1kHz
4-3 Charge Sensitivity	$0.055\text{pC/G} \pm 40\%$, under vibration at 200Hz, 2G
4-4 Insulation Resistance	0.5Gohm minimum, at 10VDC(charging time 200msec)
4-5 Resonant Frequency	90.0 kHz $\pm 20\%$
4-6 Non-linearity	5% maximum, under vibration at 25G
(Reference only) Voltage Sensitivity	0.175 mV/G, under vibration at 200Hz, 2G

<Measurement Condition>

The reference temperature shall be $25^{\circ}\text{C} \pm 5^{\circ}\text{C}$.

5.Dimensions and Marking**Marking of Polarity**

Body ; Black Colour
Lime ; Brown Colour

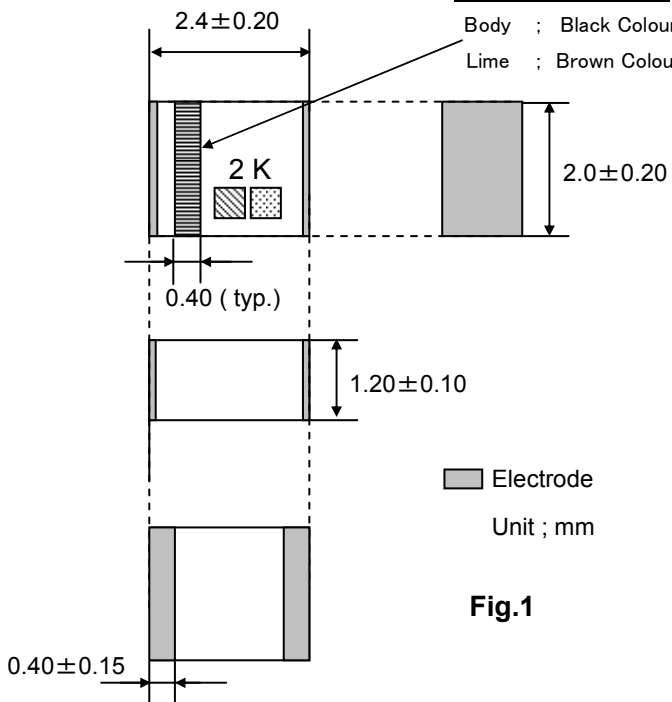
**Characteristic Spec**

2 ; Initial Primary Axis Inclined Angle

K ; Electrical Characteristics

Manufacturing Day Code :

Day	1	2	3	4	5	6	7	8	9	10	
Cade	A	B	C	D	E	F	G	H	J	K	
Day	11	12	13	14	15	16	17	18	19	20	
Cade	L	M	N	P	Q	R	S	T	U	V	
Day	21	22	23	24	25	26	27	28	29	30	31
Cade	W	X	Y	Z	a	b	c	d	e	f	g

EIAJ Date Code :

2009 Jan. ~ Dec. : A ~ M except "I"

2010 Jan. ~ Dec. : N ~ Z except "O"

2011 Jan. ~ Dec. : a ~ m except "i"

2012 Jan. ~ Dec. : n ~ z except "o"

Note : These alphabets should be repeated after Jan. 2013

6.Environmental Characteristics**Preliminary**

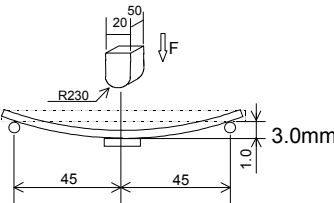
Items	Conditions
6-1.High Temperature Storage Test	Keep in a chamber at $85 \pm 2^{\circ}\text{C}$ for $1000 +12/-0$ hours, and then keep at room temperature for 1 hour. The characteristics of shock sensor shall meet the specifications.
6-2.Low Temperature Storage Test	Keep in a chamber at $-40 \pm 2^{\circ}\text{C}$ for $1000 +12/-0$ hours, and then keep at room temperature for 1 hour. The characteristics of shock sensor shall meet the specifications.
6-3.Moisture Resistance Test	Keep in a chamber at 90 to 95 % R.H. and $60 \pm 2^{\circ}\text{C}$ for $500 +12/-0$ hours, and then keep at room temperature for 1 hour. The characteristics of shock sensor shall meet the specifications.
6-4.Temperature Cycling Test	Apply 100 thermal cycles with the following temperatures: <ul style="list-style-type: none"> - upper temperature 85°C for 20 minutes and transfer time 10 minutes - lower temperature -40°C for 20 minutes and transfer time 10 minutes - total cycle time is 1hour and then left at room temperature for 1 hour. The characteristics of shock sensor shall meet the specifications.
6-5.Mechanical Shock Test	After applying the acceleration at $29430\text{m}/\text{sec}^2$ {3000G} in each of X, Y and Z axis (each 3 times). The characteristics of shock sensor shall meet the specifications.
6-6.Solderability Test	At first, being soaked in the Methanol solution containing Rosin for 5 seconds and then being dipped in a bath of Pb/Sn solder at $250 \pm 5^{\circ}\text{C}$ for 4 ± 0.5 seconds. The surface of the electrode terminal shall be soldered more than 95%.
6-7.Resistance to Soldering Heat Test	Pre-heat temperature is 150 to 180°C for 1 minute. High temperature is $250 \pm 5^{\circ}\text{C}$, over 200°C for 20 seconds max.(2times). Then keep at room temperature for 1 hour. The characteristics of shock sensor shall meet the specifications.
6-8.Board Flex Test	After soldered on the circuit board specified as below, then the load which cause 3 mm bend to the board is applied. The characteristics of shock sensor shall meet the specifications. The shock sensor cause no defect in the appearance. (Circuit Board: FR4, 100 x 40 x 1.6) 

<Measurement Condition>The reference temperature shall be $25^{\circ}\text{C} \pm 5^{\circ}\text{C}$.

7. Recommended Land pattern

Preliminary

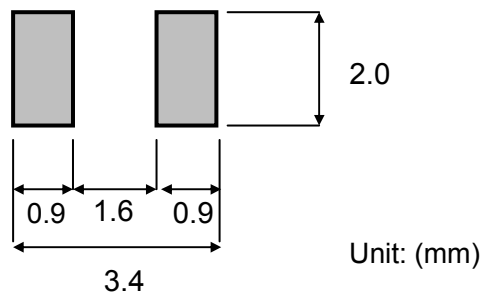

Fig.2 Recommended Land pattern

8. Recommended Convection Reflow profile

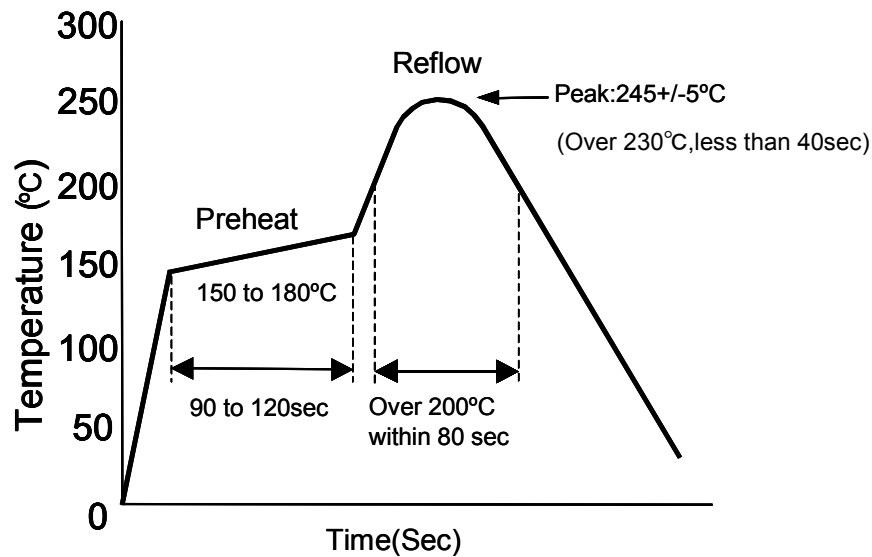
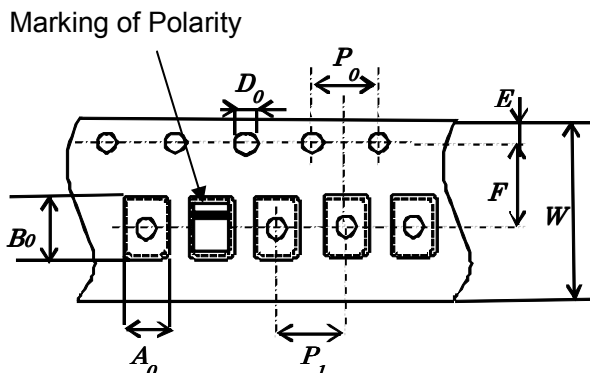

Fig.3 Recommended Convection Reflow profile

9. Taping Specifications

9-1. Carrier Tape

9-1-1. Dimensions



Sym bol	Dimensions	Sym bol	Dimensions
A_0	2.3 ± 0.1	P_0	4.0 ± 0.1
B_0	2.7 ± 0.1	P_1	4.0 ± 0.1
W	12.0 ± 0.2	D_0	$1.5 +0.1/-0$
E	1.75 ± 0.1	K	1.5 ± 0.1
F	5.5 ± 0.1	T	0.3 ± 0.1

Unit: (mm)

Fig.4 Emboss Carrier Tape Dimensions

Preliminary

9-2. Taping

9-2-1. Taping Quantity

One reel of the carrier tape shall pack 3000 pcs. Shock sensor shall be contained in pocket continuously.

9-2-2. Dimensions

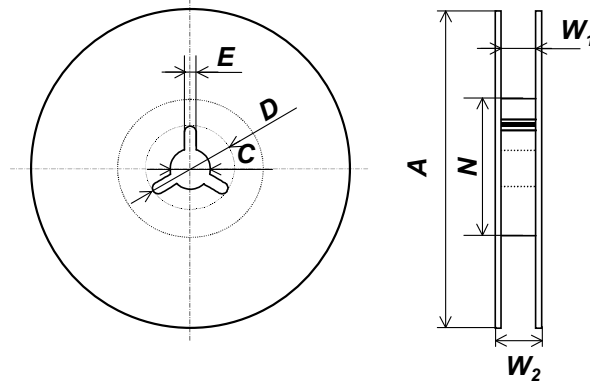

Fig.5 Reel

Unit: (mm)

Symbol	A	N	W₁	W₂
Dimensions	180±5.0	60min.	12.5 +2.0/-0.0	20.5 max.
Symbol	C	D	E	
Dimensions	13.0±0.2	21.0±0.8	2.0±0.5	

9-2-3. Leader and Blank Pocket

Package shall consist of leader, blank pocket and loaded pocket as follows. (fig.6)

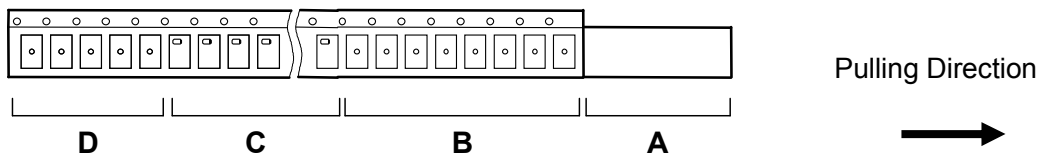

- A) Leader
- B) Blank Pocket (160mm Min.)
A+B: 400mm to 560mm
- C) Load Pocket
- D) Blank Pocket (40 to 190mm)

Fig.6 Packing Method

Peeling load of top tape shall be 0.1N {10gf} to 0.7N {70gf} from Carrier Tape.

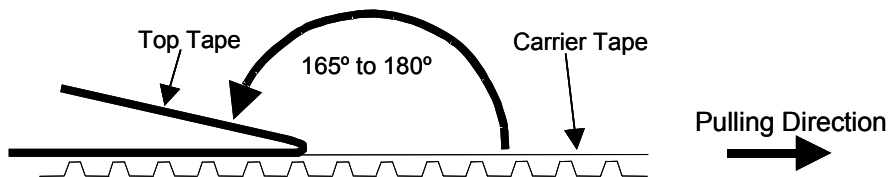

Fig.7 Peeling Strength

9-2-4. Reel label**Preliminary**

A reel label shall be contained as below: (Based on EIAJ C-3 format)

- A) Customer P/N
- B) Lot No.
- C) Quantity
- D) Shipping date
- E) Vender Name

9-2-5. Exterior Package label

Shock sensor shall be packed properly to avoid defect in transportation and the marking of exterior package shall be contained as below:

- A) Name of Customer
- B) P/O No.
- C) Customer P/N
- D) Lot No.
- E) Quantity
- F) Shipping Date

10. The agreement of this specifications

Should any part of the content of this specification become questionable, it shall be settled by mutual deliberations.

11. Caution for handling

- A) Shock and or vibration to piece parts shall not be exceed the defined specification.
- B) This parts cannot washing and cleaning after soldering process.
- C) Maximum temperature is 280 degree.
- D) Notes in soldering

Solder iron temp: 350 ± 10 degrees C

Heat time:Max 3 seconds (Accumulated time)

- Please take care of solder iron not to attach products directly.
- Please use new product attached no solder when you rework.

12.RoHS Compliant

- A) Sensor Case: Epoxy resin
- B) Terminal: Ag paste (thickness 30 um)
Plating: Ni(2um), Sn(5 um)
- C) Element: Piezo Ceramic, contains lead-oxide, however, piezo-electronic devices are exempted from RoHS compliant requirement of article 4(1).
(Refer to Annex, Section 7)

All materials meet to RoHS Compliant.

13. Halogen-Free Compliant**Preliminary**

- A) Bromine(Br) <900ppm(0.09%)
- B) Chlorine(Cl) <900ppm(0.09%)
- C) Total concentration of Chlorine(Cl) + Bromine(Br) <1500ppm(0.15%)
- D) Antimony Trioxide(Sb₂O₃) <1000ppm(0.1%)
- E) Red Phosphorus <1000ppm(0.1%)

All materials meet to Halogen-Free Compliant.

14. Others

There is a possibility of changing the specification by the result of review in the future.