

| P | LTR | DESCRIPTION | DATE | DWN | APVD |
|---|-----|-----------------------|-----------|-----|------|
| J | | REVISED ECR-10-002537 | 04FEB2010 | JC | TAP |

NOTES:

1 MATERIAL
HOUSING: HIGH TEMPERATURE THERMOPLASTIC GLASS FILLED,
UL94V-0, REGRIND 25% MAXIMUM
CONTACT: COPPER ALLOY
BOARDLOCK: COPPER ALLOY

2 FINISH
CONTACT: 0.76um MIN GOLD ON MATING AREA AND
1.91um MIN TIN (LEAD-FREE) ON SOLDER AREA,
BOTH OVER 1.27um MIN NICKEL
BOARDLOCK: 2.54um MIN TIN OVER 1.27um MIN NICKEL

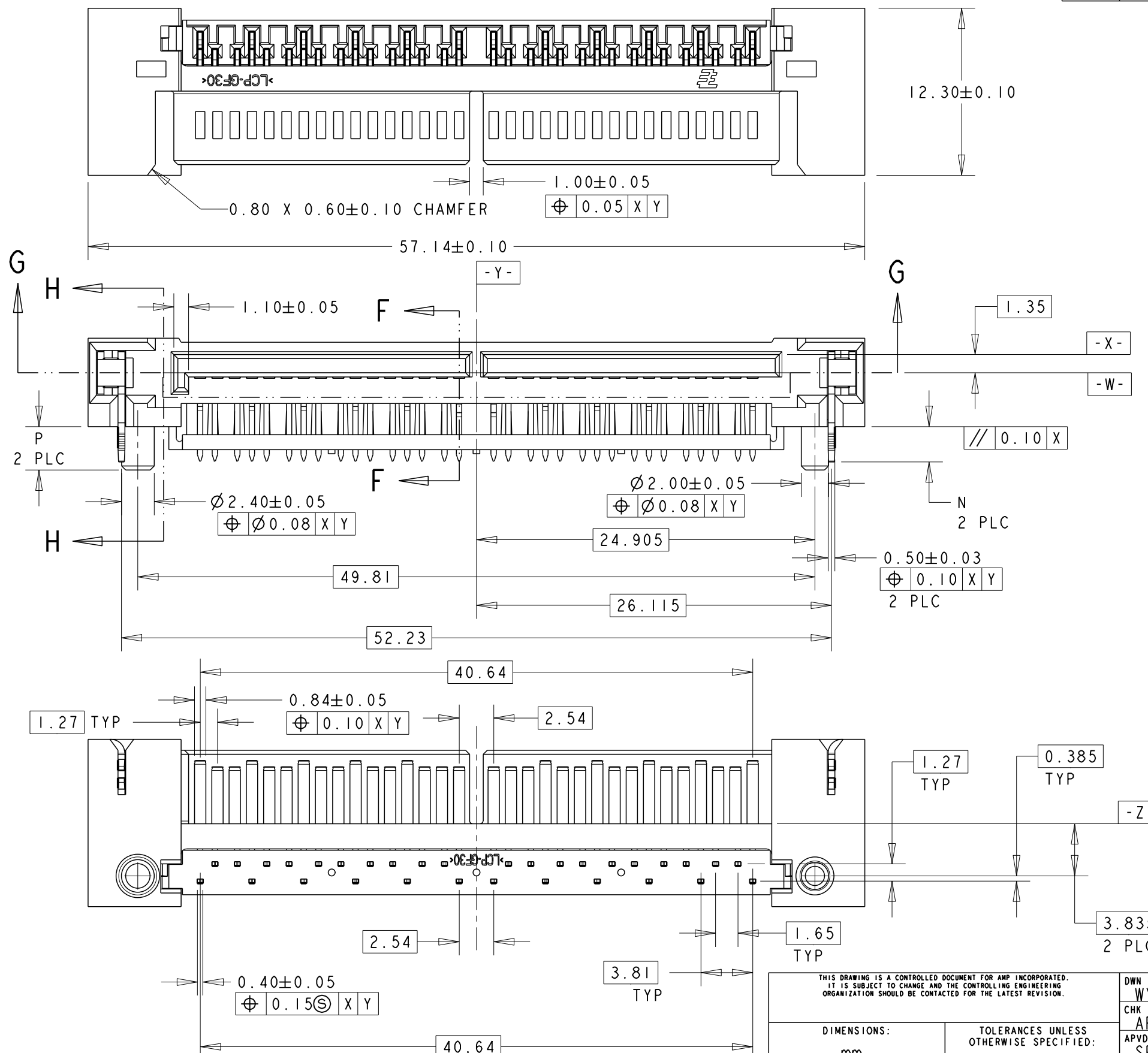
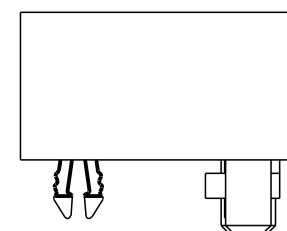

| | | | |
|---|--|---------------------------|---|
| THIS DRAWING IS A CONTROLLED DOCUMENT FOR AMP INCORPORATED. IT IS SUBJECT TO CHANGE AND THE CONTROLLING ENGINEERING ORGANIZATION SHOULD BE CONTACTED FOR THE LATEST REVISION. | | DWN WYLEE 12FEB2004 | Tyco Electronics Singapore Pte. Ltd. |
| DIMENSIONS: mm | | CHK AP TAY | |
| TOLERANCES UNLESS OTHERWISE SPECIFIED: 0 PLC ± 1 PLC ±0.15 2 PLC ±0.15 3 PLC ±0.15 4 PLC ± ANGLES ±2° | | APVD SE LEONG | NAME CONNECTOR, SAS 4i AND INTERNAL 4 LANE SATA PLUG, R/A THROUGH HOLE |
| MATERIAL 1 | | PRODUCT SPEC - | SIZE A3 |
| FINISH 2 | | APPLICATION SPEC - | CAGE CODE 00779 |
| | | WEIGHT - | DRAWING NO C-84980 |
| | | CUSTOMER DRAWING | SCALE 3:1 |
| | | | SHEET 1 OF 3 |
| | | | REV J |

THIS DRAWING IS UNPUBLISHED. RELEASED FOR PUBLICATION .19 .
 © COPYRIGHT 19 BY AMP INCORPORATED. ALL RIGHTS RESERVED.

| LOC | DIST | REVISIONS | | | | | |
|-----|------|-----------|-----|-------------|------|-----|------|
| DY | - | P | LTR | DESCRIPTION | DATE | DWN | APVD |
| | | | | SEE SHEET 1 | | | |

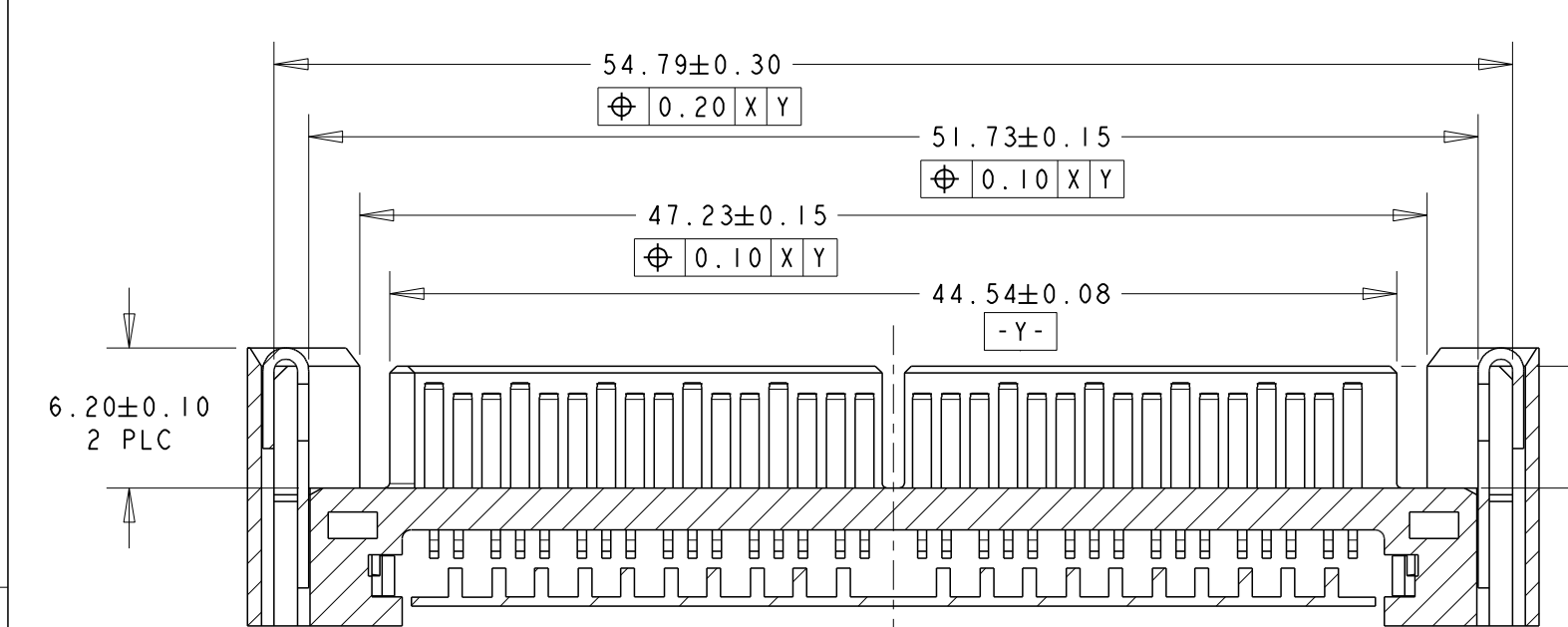
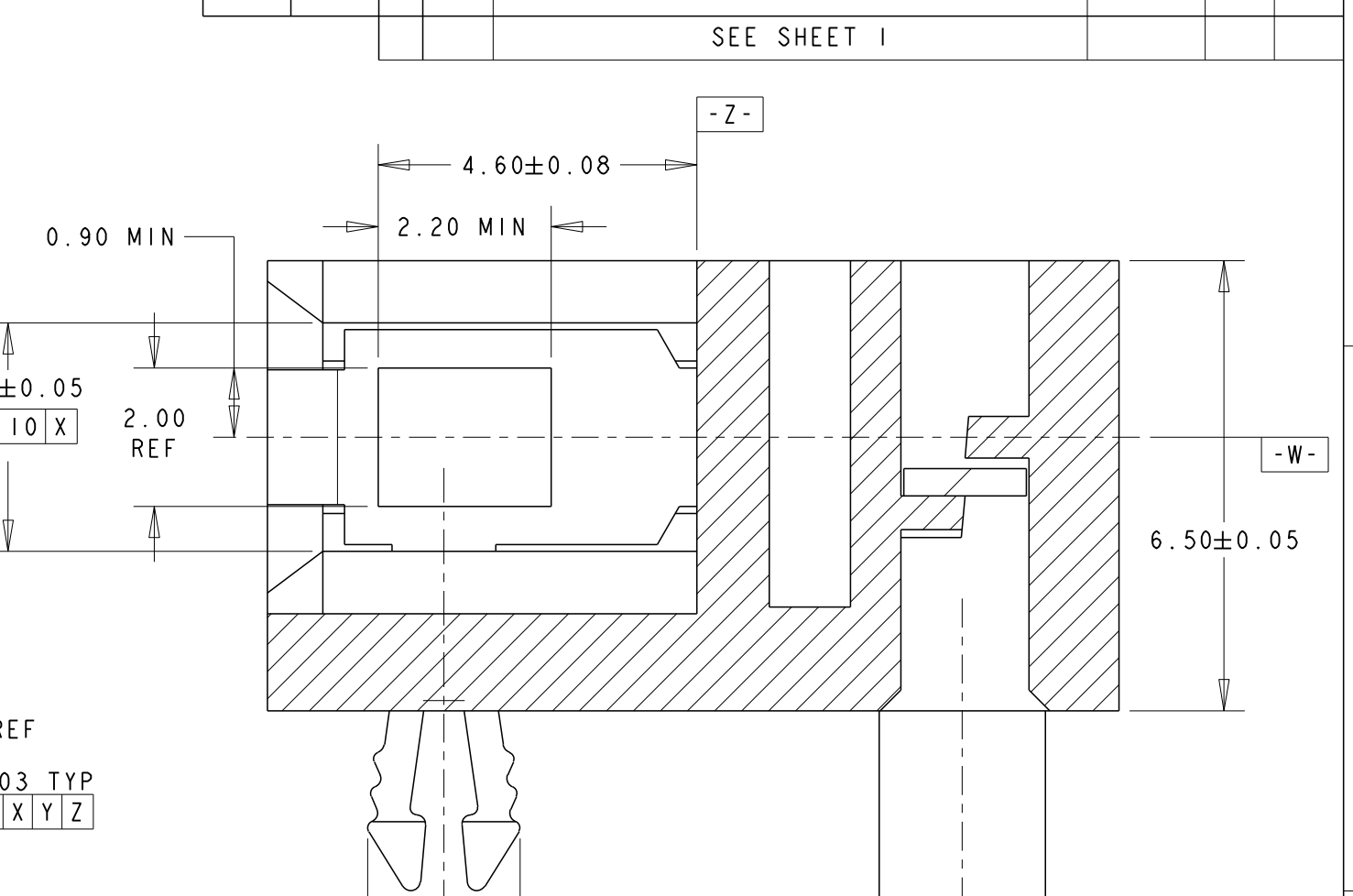
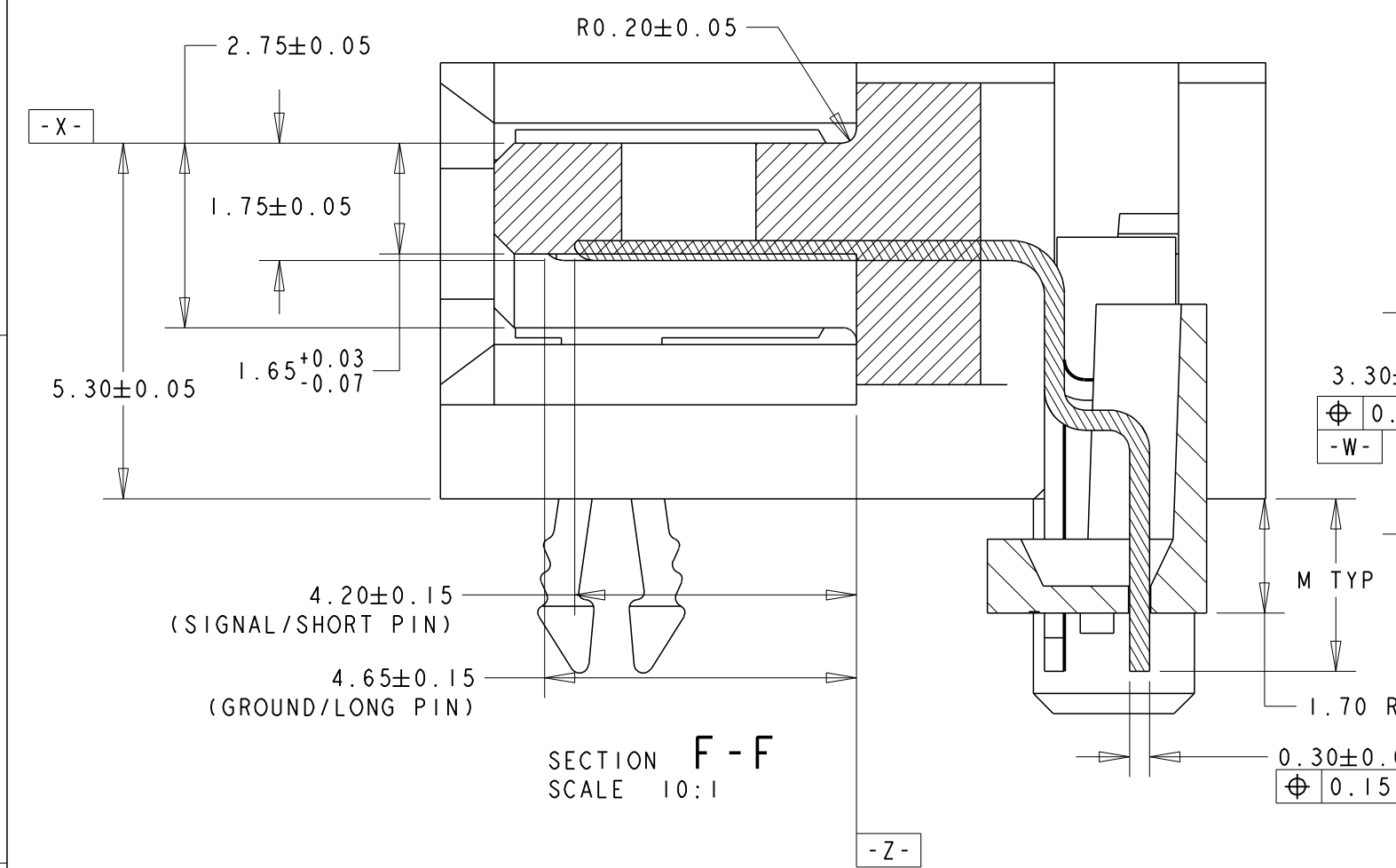

| COLOR | PCB THICKNESS | P | N | M | POS. | PART NO. |
|---------|---------------|------|------|------|--------|----------|
| NATURAL | 1.57±0.10 | 3.20 | 2.60 | 2.54 | 16+16P | 84980-5 |
| BLACK | 3.18±0.10 | 4.00 | 4.35 | 4.06 | 16+16P | 84980-4 |
| BLACK | 1.57±0.10 | 3.20 | 2.60 | 2.54 | 16+16P | 84980-3 |
| BLACK | 3.18±0.10 | 4.00 | 4.35 | 4.06 | 16+16P | 84980-2 |
| BLACK | 1.57±0.10 | 3.20 | 2.60 | 2.15 | 16+16P | 84980-1 |

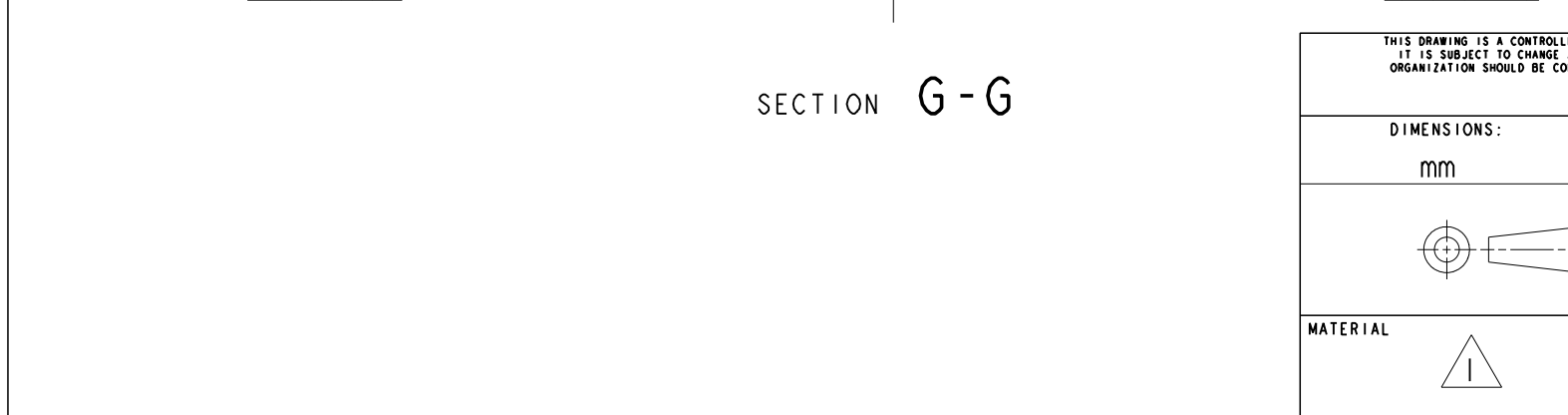

THIS DRAWING IS A CONTROLLED DOCUMENT FOR AMP INCORPORATED. IT IS SUBJECT TO CHANGE AND THE CONTROLLING ENGINEERING ORGANIZATION SHOULD BE CONTACTED FOR THE LATEST REVISION.

| | | | | | | |
|------------------|----------|-----------|---|-----------|------------|-----|
| DWN | WYLEE | 12FEB2004 | Tyco Electronics Singapore Pte. Ltd. | | | |
| CHK | AP TAY | | NAME | | | |
| APVD | SE LEONG | | CONNECTOR, SAS 4i AND INTERNAL 4 LANE SATA PLUG, R/A THROUGH HOLE | | | |
| PRODUCT SPEC | | | SIZE | CAGE CODE | DRAWING NO | |
| APPLICATION SPEC | | | A3 | 00779 | C-84980 | |
| WEIGHT | | | SCALE | SHEET | OF | REV |
| CUSTOMER DRAWING | | | 3:1 | 2 | 3 | J |

THIS DRAWING IS UNPUBLISHED. RELEASED FOR PUBLICATION .19 .
 © COPYRIGHT 19 BY AMP INCORPORATED. ALL RIGHTS RESERVED.

| LOC | DIST | REVISIONS | | | | | |
|-----|------|-----------|-----|-------------|------|-----|------|
| DY | - | P | LTR | DESCRIPTION | DATE | DWN | APVD |
| | | | | SEE SHEET 1 | | | |

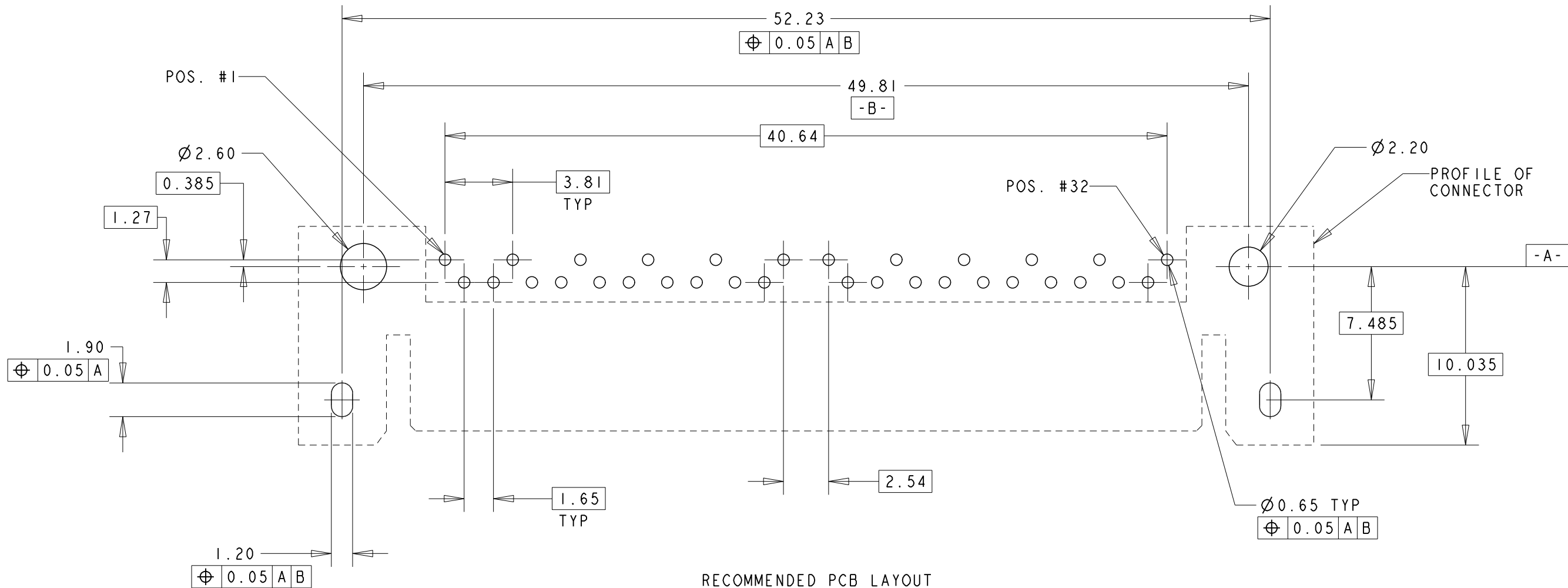

RECOMMENDED PCB LAYOUT
 (ALL TOLERANCE ARE ±0.05)
 SCALE 4:1

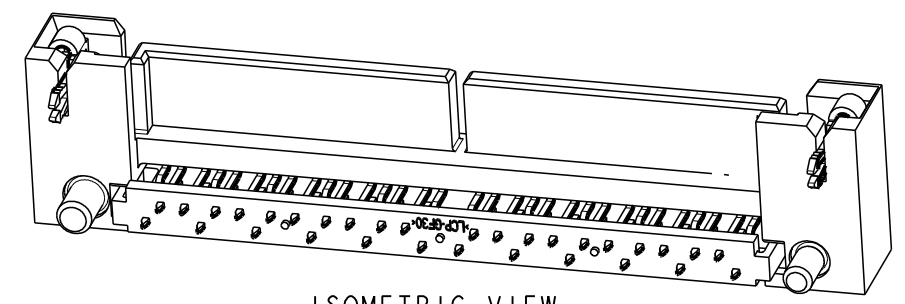

ISOMETRIC VIEW
 SCALE 2:1

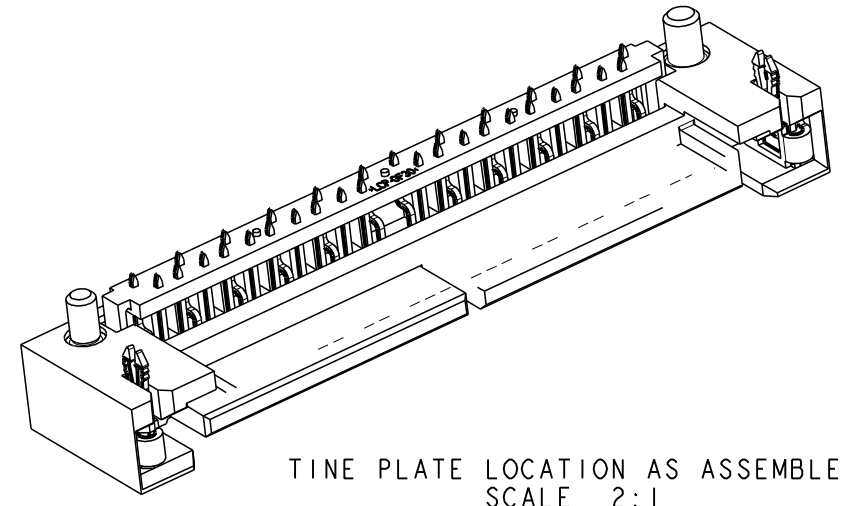

TINE PLATE LOCATION AS ASSEMBLED
 SCALE 2:1

| | | | | | |
|---|--|-------------------|-----------------------|---|--------------------|
| THIS DRAWING IS A CONTROLLED DOCUMENT FOR AMP INCORPORATED. IT IS SUBJECT TO CHANGE AND THE CONTROLLING ENGINEERING ORGANIZATION SHOULD BE CONTACTED FOR THE LATEST REVISION. | | DWN WYLEE | 12FEB2004 | Tyco Electronics Singapore Pte. Ltd. | |
| DIMENSIONS: mm | | CHK AP TAY | APVD SE LEONG | NAME CONNECTOR, SAS 4i AND INTERNAL 4 LANE SATA PLUG, R/A THROUGH HOLE | |
| TOLERANCES UNLESS OTHERWISE SPECIFIED: 0 PLC ± 1 PLC ±0.15 2 PLC ±0.15 3 PLC ±0.15 4 PLC ± ANGLES ±2° | | PRODUCT SPEC - | APPLICATION SPEC - | SIZE A3 | CAGE CODE 00779 |
| MATERIAL 1 | | FINISH 2 | WEIGHT - | DRAWING NO C-84980 | |
| CUSTOMER DRAWING | | | SCALE 3:1 | SHEET 3 OF 3 | REV J |