

LED DISPLAY

LTD-5250JG-18J

DATA SHEET

Rev	Description	By
01	RDR Original Spec	Phanomkorn
02	Change face color from gray to black	Phanomkorn
-	NPPR Original Spec	Phanomkorn

SPEC. NO.: DS30-2007-0211

D A T E : 28/Dec /'07

REV. NO. : -

LITEON LITE-ON TECHNOLOGY CORPORATION

Property of Lite-On Only

FEATURES

- * 0.52 inch (13.2 mm) DIGIT HEIGHT.
- * CONTINUOUS UNIFORM SEGMENTS.
- * LOW POWER REQUIREMENT.
- * EXCELLENT CHARACTERS APPEARANCE.
- * HIGH BRIGHTNESS & HIGH CONTRAST.
- * WIDE VIEWING ANGLE.
- * SOLID STATE RELIABILITY.
- * CATEGORIZED FOR LUMINOUS INTENSITY.
- * **LEAD-FREE PACKAGE (ACCORDING TO ROHS)**

DESCRIPTION

The LTD-5250JG-18J is a 0.52 inch (13.2 mm) digit height dual digit seven-segment display. This device uses AlInGaP Green LED chips, which are made from AlInGaP on a non-transparent GaAs. The display has a black face and white segments.

DEVICE

PART NO.	DESCRIPTION
AlInGaP Green	Common Anode
LTD-5250JG-18J	Rt. Hand Decimal

PACKAGE DIMENSIONS

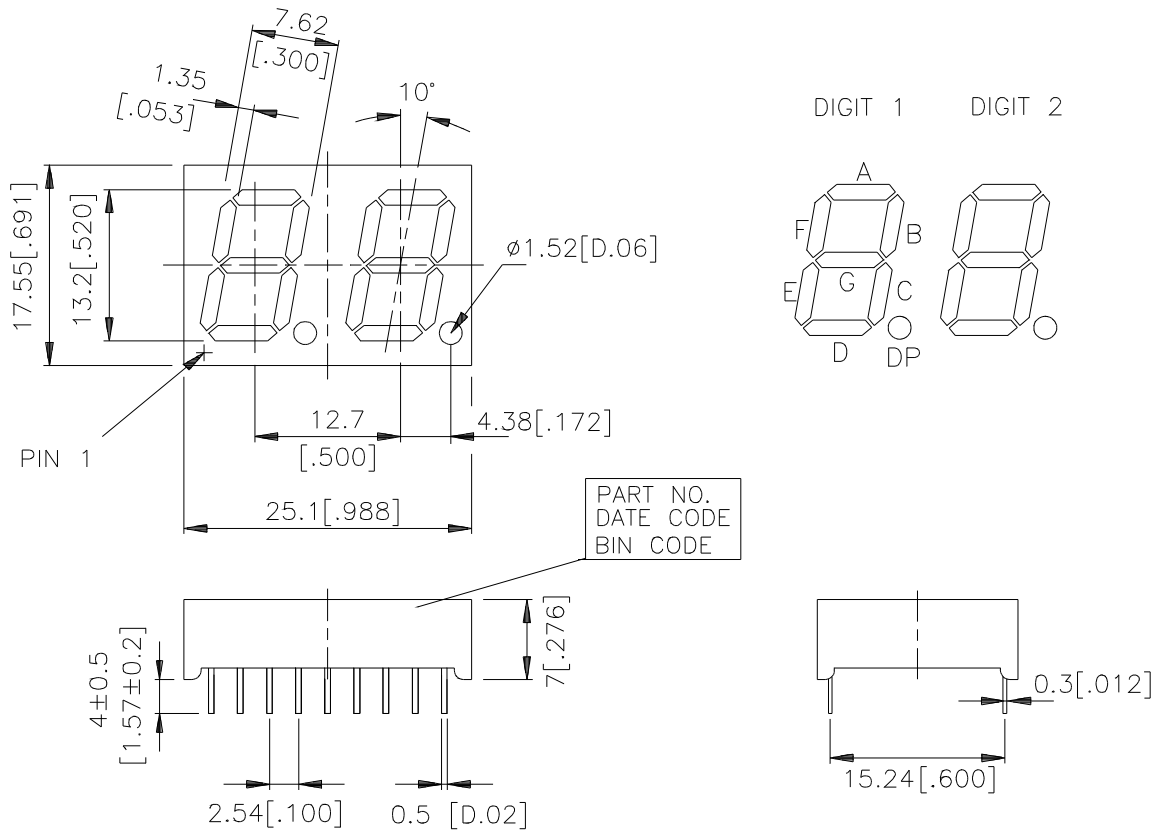

- NOTES: 1. All dimensions are in millimeters. Tolerances are ± 0.25 mm unless otherwise note.
 2. Pin tip's shift tolerance is ± 0.4 mm.

INTERNAL CIRCUIT DIAGRAM

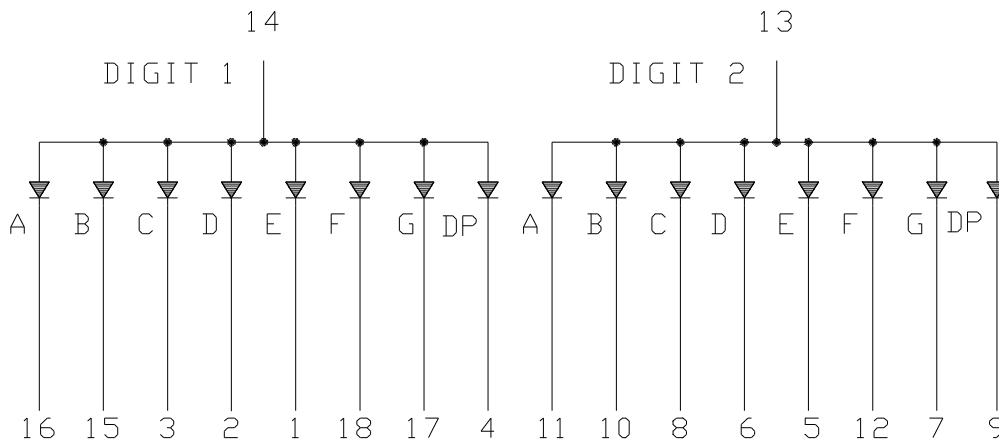

PIN CONNECTION

No.	CONNECTION
1	CATHODE E (DIGIT 1)
2	CATHODE D (DIGIT 1)
3	CATHODE C (DIGIT 1)
4	CATHODE D.P. (DIGIT 1)
5	CATHODE E (DIGIT 2)
6	CATHODE D (DIGIT 2)
7	CATHODE G (DIGIT 2)
8	CATHODE C (DIGIT 2)
9	CATHODE D.P. (DIGIT 2)
10	CATHODE B (DIGIT 2)
11	CATHODE A (DIGIT 2)
12	CATHODE F (DIGIT 2)
13	COMMON ANODE (DIGIT 2)
14	COMMON ANODE (DIGIT 1)
15	CATHODE B (DIGIT 1)
16	CATHODE A (DIGIT 1)
17	CATHODE G (DIGIT 1)
18	CATHODE F (DIGIT 1)

LITEON LITE-ON TECHNOLOGY CORPORATION

Property of Lite-On Only

ABSOLUTE MAXIMUM RATING AT Ta=25°C

PARAMETER	MAXIMUM RATING	UNIT
Power Dissipation Per Segment	70	mW
Peak Forward Current Per Segment (1/10 Duty Cycle, 0.1ms Pulse Width)	60	mA
Continuous Forward Current Per Segment Derating Linear From 25°C Per Segment	25 0.33	mA mA/°C
Reverse Voltage Per Segment	5	V
Operating Temperature Range	-35°C to +105°C	
Storage Temperature Range	-35°C to +105°C	
Soldering Conditions: 1/16 inch below seating plane for 3 seconds at 260°C or of temperature unit (during assembly) not over max. temperature rating above.		

ELECTRICAL / OPTICAL CHARACTERISTICS AT Ta=25°C

PARAMETER	SYMBOL	MIN.	TYP.	MAX.	UNIT	TEST CONDITION
Average Luminous Intensity	I _v	200	630		μcd	I _F =1mA
Peak Emission Wavelength	λ _p		571		nm	I _F =20mA
Spectral Line Half-Width	Δλ		15		nm	I _F =20mA
Dominant Wavelength	λ _d		572		nm	I _F =20mA
Forward Voltage Per Segment	V _F		2.05	2.6	V	I _F =20mA
Reverse Current Per Segment	I _R			100	μA	V _R =5V
Luminous Intensity Matching Ratio (Similar Light Area)	I _{v-m}			2:1		I _F =1mA

Note: Luminous intensity is measured with a light sensor and filter combination that approximates the CIE (Commission Internationale De L'Eclairage) eye-response curve.

TYPICAL ELECTRICAL / OPTICAL CHARACTERISTIC CURVES

(25°C Ambient Temperature Unless Otherwise Noted)

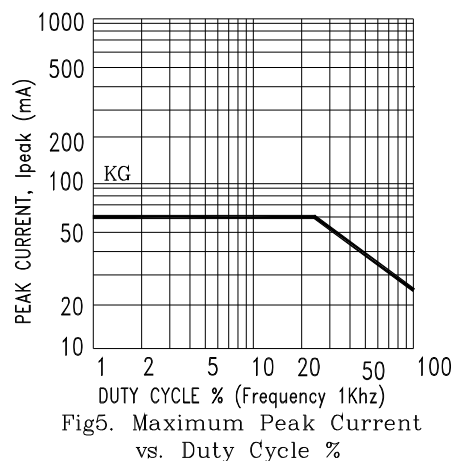
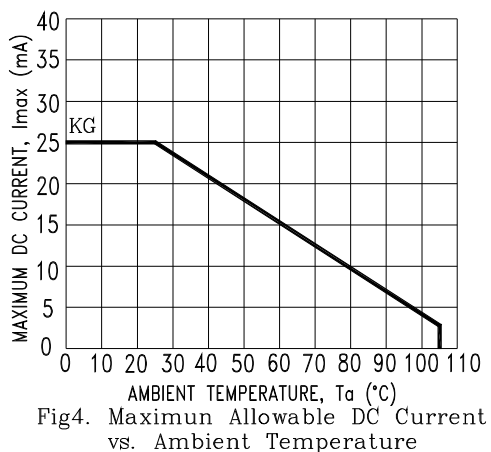
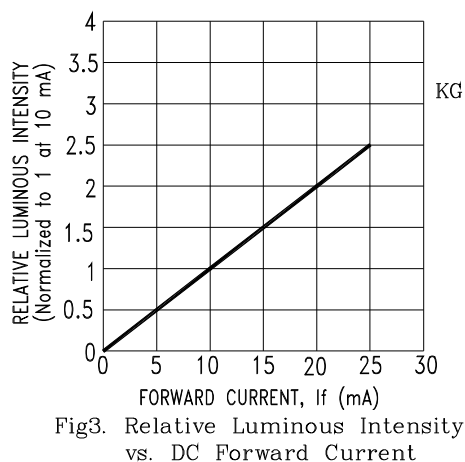
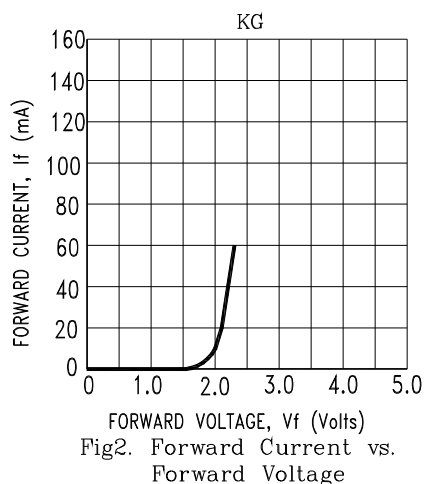
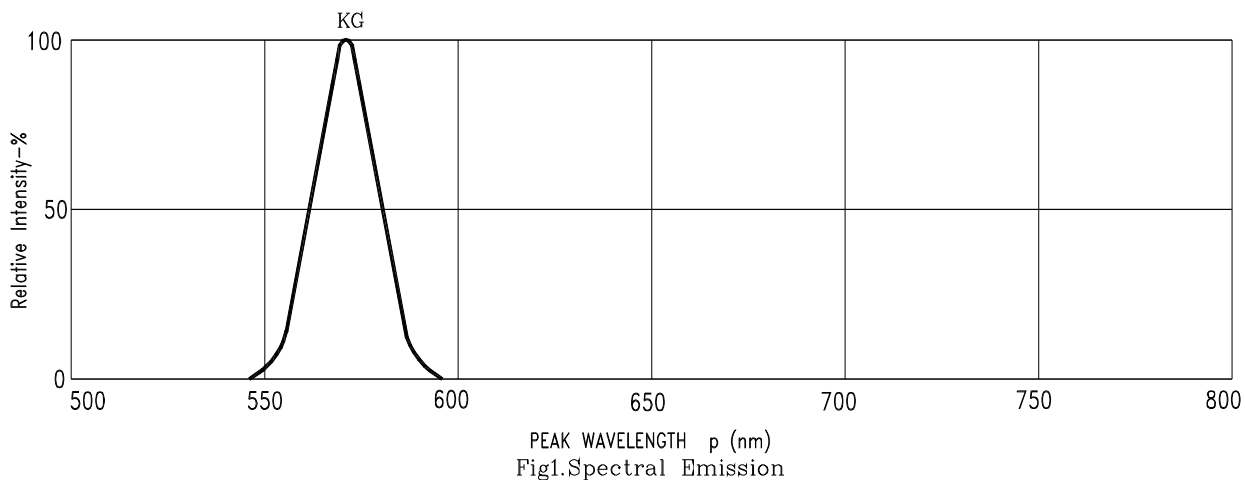

NOTE : KG=AlInGaP Green