

RF Power LDMOS Transistor

N-Channel Enhancement-Mode Lateral MOSFET

RF power transistor suitable for industrial heating applications operating at 2450 MHz. Device is capable of both CW and pulse operation.

- Typical CW Performance at 2450 MHz, $V_{DD} = 28$ Vdc, $I_{DQ} = 1200$ mA, $P_{out} = 140$ W
Power Gain — 13.2 dB
Drain Efficiency — 45%
- Capable of Handling 10:1 VSWR, @ 28 Vdc, 2390 MHz, 140 W CW Output Power

Features

- Characterized with Series Equivalent Large-Signal Impedance Parameters
- Internally Matched for Ease of Use
- Qualified up to a Maximum of 32 V_{DD} Operation
- Integrated ESD Protection
- In Tape and Reel. R5 Suffix = 50 Units per 56 mm Tape Width, 13-inch Reel.

MHT1000HR5

**2450 MHz, 140 W CW, 28 V
INDUSTRIAL HEATING, RUGGED
RF POWER LDMOS TRANSISTOR**

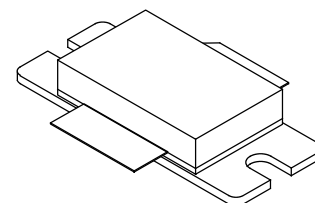

NI-880H-2L

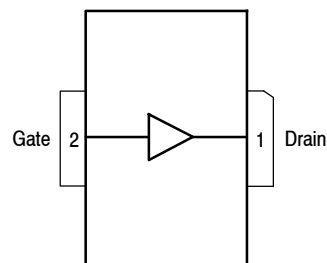

(Top View)

Note: The backside of the package is the source terminal for the transistor.

Figure 1. Pin Connections

Table 1. Maximum Ratings

Rating	Symbol	Value	Unit
Drain-Source Voltage	V_{DSS}	-0.5, +68	Vdc
Gate-Source Voltage	V_{GS}	-0.5, +12	Vdc
Storage Temperature Range	T_{stg}	-65 to +150	°C
Case Operating Temperature	T_C	150	°C
Operating Junction Temperature (1,2)	T_J	225	°C

Table 2. Thermal Characteristics

Characteristic	Symbol	Value (2,3)	Unit
Thermal Resistance, Junction to Case Case Temperature 82°C, 140 W CW	$R_{\theta JC}$	0.29	°C/W

1. Continuous use at maximum temperature will affect MTTF.
2. MTTF calculator available at <http://www.freescale.com/rf>. Select Software & Tools/Development Tools/Calculators to access MTTF calculators by product.
3. Refer to AN1955, *Thermal Measurement Methodology of RF Power Amplifiers*. Go to <http://www.freescale.com/rf>. Select Documentation/Application Notes - AN1955.

Table 3. ESD Protection Characteristics

Test Methodology	Class
Human Body Model (per JESD22-A114)	1C
Machine Model (per EIA/JESD22-A115)	A
Charge Device Model (per JESD22-C101)	III

Table 4. Electrical Characteristics ($T_A = 25^\circ\text{C}$ unless otherwise noted)

Characteristic	Symbol	Min	Typ	Max	Unit
----------------	--------	-----	-----	-----	------

Off Characteristics

Zero Gate Voltage Drain Leakage Current ($V_{DS} = 68\text{ Vdc}$, $V_{GS} = 0\text{ Vdc}$)	I_{DSS}	—	—	10	μAdc
Zero Gate Voltage Drain Leakage Current ($V_{DS} = 28\text{ Vdc}$, $V_{GS} = 0\text{ Vdc}$)	I_{DSS}	—	—	1	μAdc
Gate-Source Leakage Current ($V_{GS} = 5\text{ Vdc}$, $V_{DS} = 0\text{ Vdc}$)	I_{GSS}	—	—	500	nAdc

On Characteristics

Gate Threshold Voltage ($V_{DS} = 10\text{ Vdc}$, $I_D = 300\ \mu\text{Adc}$)	$V_{GS(th)}$	1	2	3	Vdc
Gate Quiescent Voltage ($V_{DD} = 28\text{ Vdc}$, $I_D = 1300\ \text{mAdc}$, Measured in Functional Test)	$V_{GS(Q)}$	2	2.8	4	Vdc
Drain-Source On-Voltage ($V_{GS} = 10\text{ Vdc}$, $I_D = 3\text{ Adc}$)	$V_{DS(on)}$	0.1	0.21	0.3	Vdc

Dynamic Characteristics ⁽¹⁾

Reverse Transfer Capacitance ($V_{DS} = 28\text{ Vdc} \pm 30\ \text{mV(rms)ac}$ @ 1 MHz, $V_{GS} = 0\text{ Vdc}$)	C_{rss}	—	2	—	pF
--	-----------	---	---	---	----

Functional Tests (In Freescale Test Fixture, 50 ohm system) $V_{DD} = 28\text{ Vdc}$, $I_{DQ} = 1300\ \text{mA}$, $P_{out} = 28\ \text{W Avg.}$, $f = 2390\ \text{MHz}$, 2-Carrier W-CDMA, 3.84 MHz Channel Bandwidth Carriers. ACPR measured in 3.84 MHz Channel Bandwidth @ $\pm 5\ \text{MHz}$ Offset. IM3 measured in 3.84 MHz Bandwidth @ $\pm 10\ \text{MHz}$ Offset. Input Signal PAR = 8.5 dB @ 0.01% Probability on CCDF.

Power Gain	G_{ps}	13	15.2	17	dB
Drain Efficiency	η_D	23	25	—	%
Intermodulation Distortion	IM3	—	-37	-35	dBc
Adjacent Channel Power Ratio	ACPR	—	-40	-38	dBc
Input Return Loss	IRL	—	-15	—	dB

1. Part internally matched both on input and output.

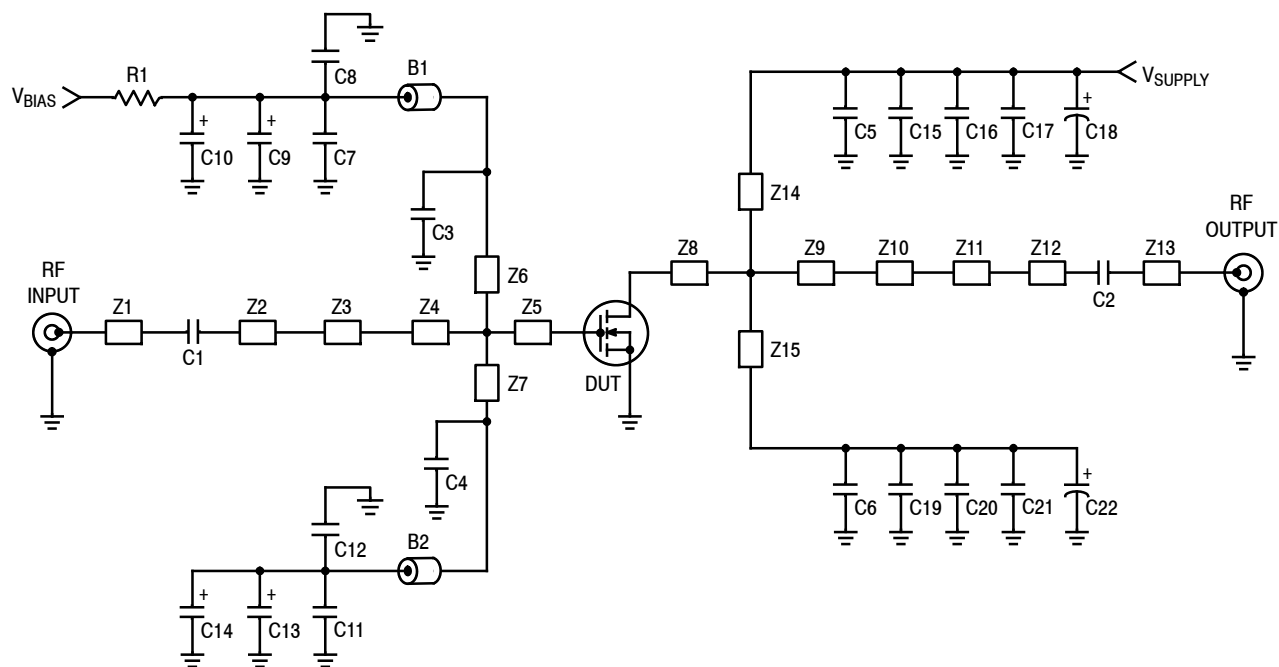

Z1	0.678" x 0.068" Microstrip	Z9	0.193" x 1.170" Microstrip
Z2	0.466" x 0.068" Microstrip	Z10	0.115" x 0.550" Microstrip
Z3	0.785" x 0.200" Microstrip	Z11	0.250" x 0.110" Microstrip
Z4	0.200" x 0.530" Microstrip	Z12	0.538" x 0.068" Microstrip
Z5	0.025" x 0.530" Microstrip	Z13	0.957" x 0.068" Microstrip
Z6, Z7	0.178" x 0.050" Microstrip	Z14, Z15	0.673" x 0.095" Microstrip
Z8	0.097" x 1.170" Microstrip	PCB	Taconic RF-35 0.030", $\epsilon_r = 3.5$

Figure 1. MHT1000HR5 Test Circuit Schematic — 2450 MHz

Table 5. MHT1000HR5 Test Circuit Component Designations and Values

Part	Description	Part Number	Manufacturer
B1, B2	47 Ω , 100 MHz Short Ferrite Beads, Surface Mount	2743019447	Fair-Rite
C1, C2, C3, C4, C5, C6	5.6 pF Chip Capacitors	ATC600B5R6BT500XT	ATC
C7, C11	0.01 μ F, 100 V Chip Capacitors	C1825C103J1RAC	Kemet
C8, C12, C15, C19	2.2 μ F, 50 V Chip Capacitors	C1825C225J5RAC	Kemet
C9, C13	22 μ F, 25 V Tantalum Capacitors	T491D226M025AT	Kemet
C10, C14	47 μ F, 16 V Tantalum Capacitors	T491D476K016AT	Kemet
C16, C17, C20, C21	10 μ F, 50 V Chip Capacitors	GRM55DR61H106KA88B	Murata
C18, C22	220 μ F, 50 V Electrolytic Capacitors	2222-150-95102	Vishay
R1	240 Ω , 1/4 W Chip Resistor	CRC12062400FKEA	Vishay

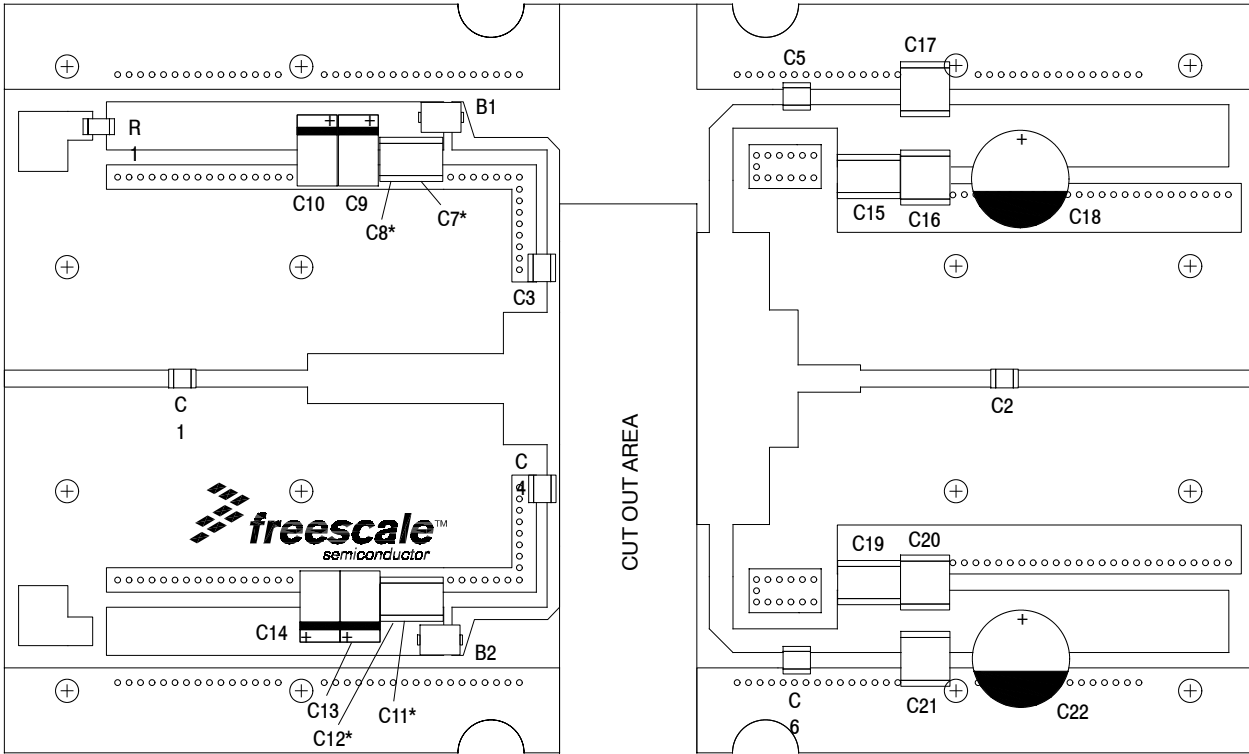

* Stacked

Figure 2. MHT100HR5 Test Circuit Component Layout

TYPICAL CHARACTERISTICS — 2450 MHz

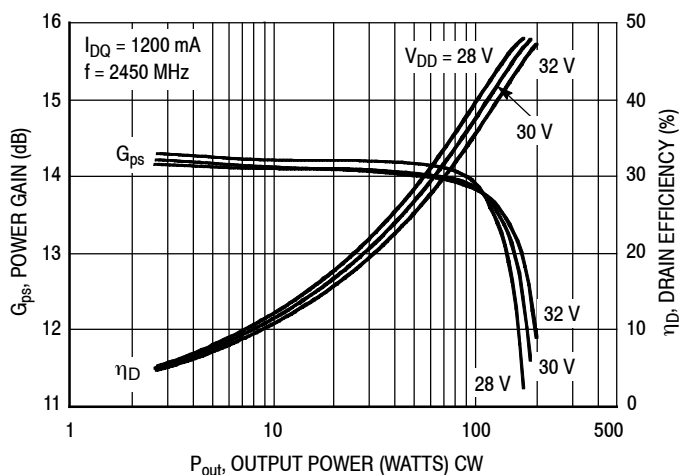

Figure 3. Power Gain and Drain Efficiency versus CW Output Power as a Function of V_{DD}

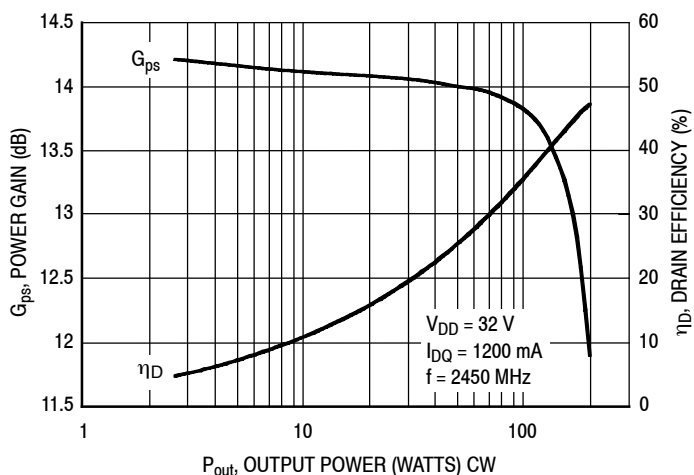

Figure 4. Power Gain and Drain Efficiency versus CW Output Power

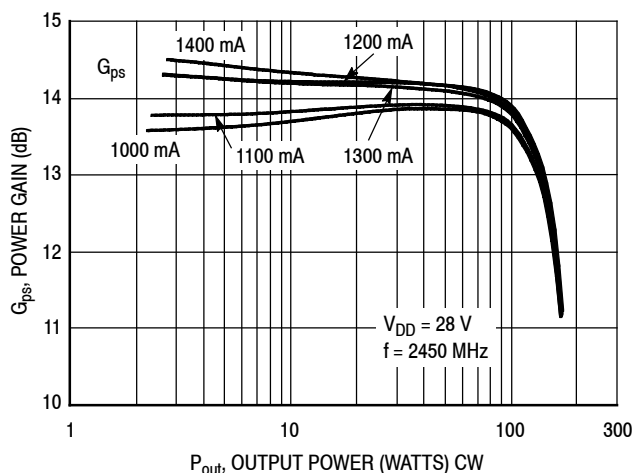
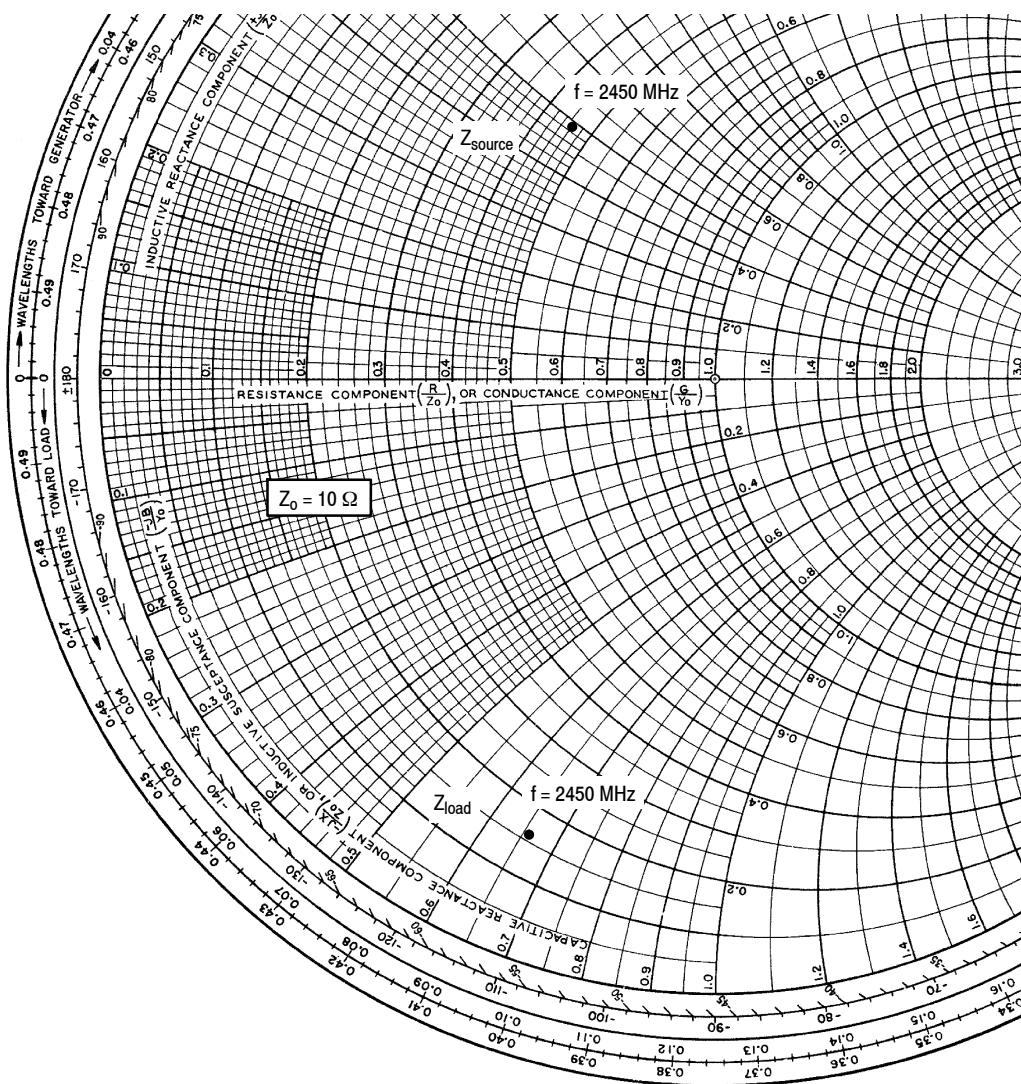

Figure 5. Power Gain and Drain Efficiency versus CW Output Power as a Function of Total I_{DQ}



$V_{DD} = 28 \text{ Vdc}$, $I_{DQ} = 1200 \text{ mA}$, $P_{out} = 140 \text{ W CW}$

f MHz	Z_{source} Ω	Z_{load} Ω
2450	$4.55 + j4.9$	$1.64 - j6.57$

Z_{source} = Test circuit impedance as measured from gate to ground.

Z_{load} = Test circuit impedance as measured from drain to ground.

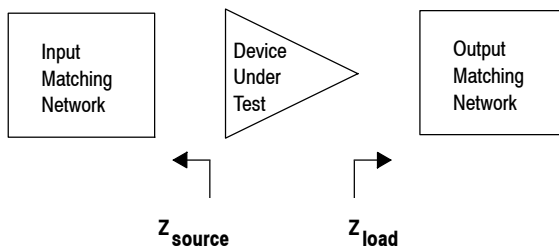
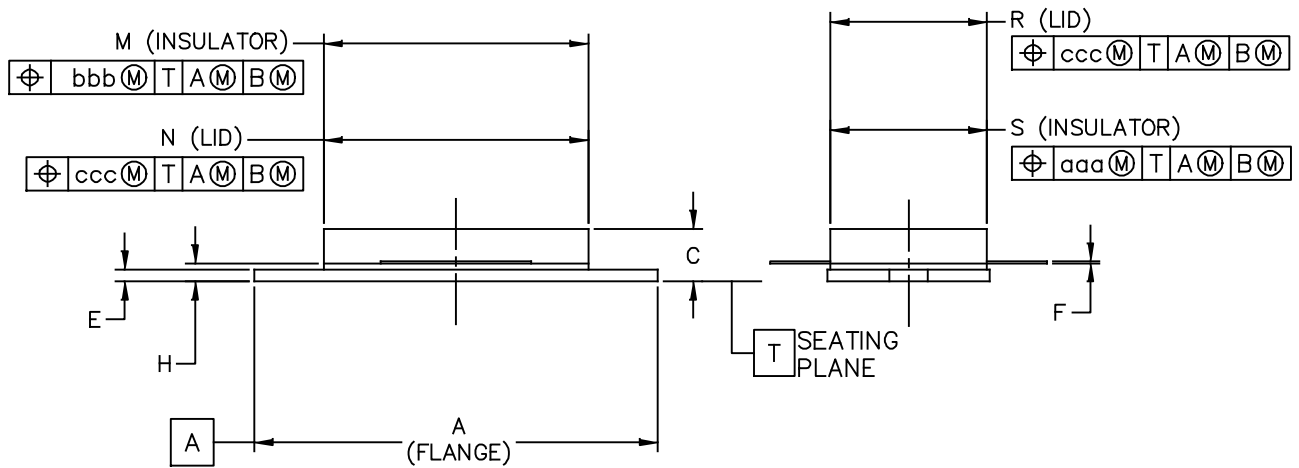
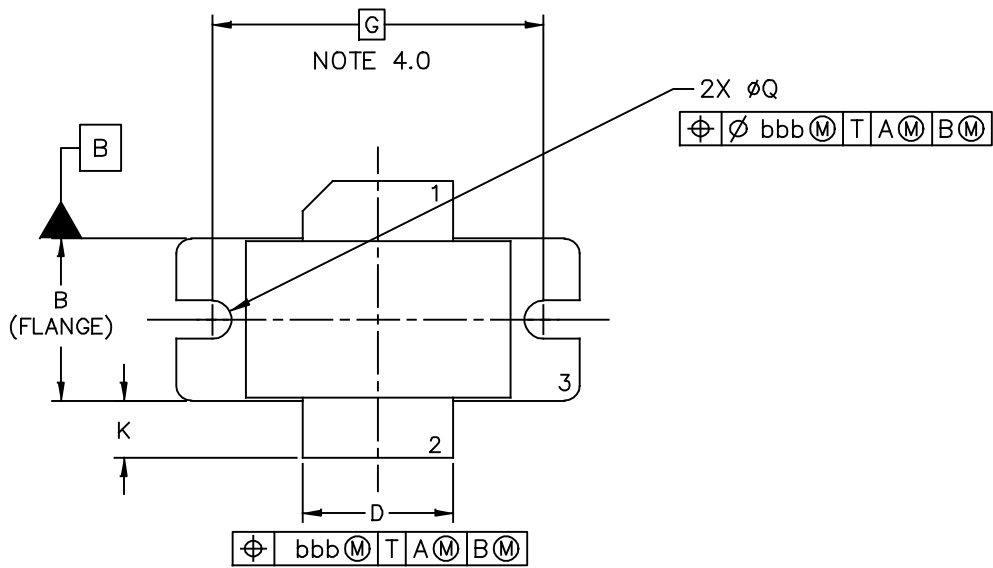

Figure 6. Series Equivalent Source and Load Impedance

PACKAGE DIMENSIONS



© FREESCALE SEMICONDUCTOR, INC. ALL RIGHTS RESERVED.	MECHANICAL OUTLINE	PRINT VERSION NOT TO SCALE	
TITLE: NI-880	DOCUMENT NO: 98ARB18493C	REV: F	
	CASE NUMBER: 465B-04	26 MAY 2011	
	STANDARD: NON-JEDEC		



NOTES:

- 1.0 DIMENSIONING AND TOLERANCING PER ANSI Y14.5M-1994.
- 2.0 CONTROLLING DIMENSION: INCH.
- 3.0 DIMENSION H IS MEASURED .030 (0.762) AWAY FROM PACKAGE BODY.
- 4.0 RECOMMENDED BOLT CENTER DIMENSION OF 1.16 (29.57) BASED ON M3 SCREW.

DIM	INCH		MILLIMETER		DIM	INCH		MILLIMETER	
	MIN	MAX	MIN	MAX		MIN	MAX	MIN	MAX
A	1.335	1.345	33.91	34.16	R	.515	– .525	13.08	– 13.34
B	.535	.545	13.59	13.84	S	.515	– .525	13.08	– 13.34
C	.147	.200	3.73	5.08	aaa	–	.007 –	–	0.178 –
D	.495	.505	12.57	12.83	bbb	–	.010 –	–	0.254 –
E	.035	.045	0.89	1.14	ccc	–	.015 –	–	0.381 –
F	.003	.006	0.08	0.15	–	–	– –	–	– –
G	1.100 BSC		27.94 BSC		–	–	– –	–	– –
H	.057	.067	1.45	1.70	–	–	– –	–	– –
K	.175	.205	4.45	5.21	–	–	– –	–	– –
M	.872	.888	22.15	22.56	–	–	– –	–	– –
N	.871	.889	22.12	22.58	–	–	– –	–	– –
Q	∅.118	∅.138	∅3.00	∅3.51	–	–	– –	–	– –
© FREESCALE SEMICONDUCTOR, INC. ALL RIGHTS RESERVED.			MECHANICAL OUTLINE			PRINT VERSION NOT TO SCALE			
TITLE: NI-880					DOCUMENT NO: 98ARB18493C			REV: F	
					CASE NUMBER: 465B-04			26 MAY 11	
					STANDARD: NON-JEDEC				

PRODUCT DOCUMENTATION AND SOFTWARE

Refer to the following resources to aid your design process.

Application Notes

- AN1955: Thermal Measurement Methodology of RF Power Amplifiers

Engineering Bulletins

- EB212: Using Data Sheet Impedances for RF LDMOS Devices

Software

- Electromigration MTTF Calculator

For Software, do a Part Number search at <http://www.freescale.com>, and select the “Part Number” link. Go to the Software & Tools tab on the part’s Product Summary page to download the respective tool.

REVISION HISTORY

The following table summarizes revisions to this document.

Revision	Date	Description
0	May 2014	<ul style="list-style-type: none"> • Initial Release of Data Sheet

How to Reach Us:

Home Page:
freescale.com

Web Support:
freescale.com/support

Information in this document is provided solely to enable system and software implementers to use Freescale products. There are no express or implied copyright licenses granted hereunder to design or fabricate any integrated circuits based on the information in this document.

Freescale reserves the right to make changes without further notice to any products herein. Freescale makes no warranty, representation, or guarantee regarding the suitability of its products for any particular purpose, nor does Freescale assume any liability arising out of the application or use of any product or circuit, and specifically disclaims any and all liability, including without limitation consequential or incidental damages. "Typical" parameters that may be provided in Freescale data sheets and/or specifications can and do vary in different applications, and actual performance may vary over time. All operating parameters, including "typicals," must be validated for each customer application by customer's technical experts. Freescale does not convey any license under its patent rights nor the rights of others. Freescale sells products pursuant to standard terms and conditions of sale, which can be found at the following address: freescale.com/SalesTermsandConditions.

Freescale and the Freescale logo are trademarks of Freescale Semiconductor, Inc., Reg. U.S. Pat. & Tm. Off. All other product or service names are the property of their respective owners.

© 2014 Freescale Semiconductor, Inc.