



User Manual

AIMB-213

**Intel® Atom™ N455/D525
1.66/1.8 GHz Mini-ITX
with VGA/DVI/LVDS, 6 COMs,
Dual LANs, 8 USBs, Mini PCIe**

ADVANTECH

Enabling an Intelligent Planet

Copyright

The documentation and the software included with this product are copyrighted 2011 by Advantech Co., Ltd. All rights are reserved. Advantech Co., Ltd. reserves the right to make improvements in the products described in this manual at any time without notice. No part of this manual may be reproduced, copied, translated or transmitted in any form or by any means without the prior written permission of Advantech Co., Ltd. Information provided in this manual is intended to be accurate and reliable. However, Advantech Co., Ltd. assumes no responsibility for its use, nor for any infringements of the rights of third parties, which may result from its use.

Acknowledgements

AWARD is a trademark of Phoenix Technologies Ltd.

IBM and PC are trademarks of International Business Machines Corporation.

Intel® Atom™ N455/D525 is trademark of Intel Corporation

WinBond is a trademark of Winbond Corporation.

All other product names or trademarks are properties of their respective owners.

A Message to the Customer

Advantech Customer Services

Each and every Advantech product is built to the most exacting specifications to ensure reliable performance in the harsh and demanding conditions typical of industrial environments. Whether your new Advantech equipment is destined for the laboratory or the factory floor, you can be assured that your product will provide the reliability and ease of operation for which the name Advantech has come to be known.

Your satisfaction is our primary concern. Here is a guide to Advantech's customer services. To ensure you get the full benefit of our services, please follow the instructions below carefully.

Technical Support

We want you to get the maximum performance from your products. So if you run into technical difficulties, we are here to help. For the most frequently asked questions, you can easily find answers in your product documentation. These answers are normally a lot more detailed than the ones we can give over the phone.

So please consult this manual first. If you still cannot find the answer, gather all the information or questions that apply to your problem, and with the product close at hand, call your dealer. Our dealers are well trained and ready to give you the support you need to get the most from your Advantech products. In fact, most problems reported are minor and are able to be easily solved over the phone.

In addition, free technical support is available from Advantech engineers every business day. We are always ready to give advice on application requirements or specific information on the installation and operation of any of our products.

Declaration of Conformity

FCC Class B

This device complies with the requirements in part 15 of the FCC rules:

Operation is subject to the following two conditions:

- This device may not cause harmful interference
- This device must accept any interference received, including interference that may cause undesired operation.

This equipment has been tested and found to comply with the limits for a Class B digital device, pursuant to Part 15 of the FCC Rules. These limits are designed to provide reasonable protection against harmful interference when the equipment is operated in a commercial environment. This equipment generates, uses, and can radiate radio frequency energy and, if not installed and used in accordance with the instruction manual, may cause harmful interference to radio communications. Operation of this device in a residential area is likely to cause harmful interference in which case the user will be required to correct the interference at his/her own expense. The user is advised that any equipment changes or modifications not expressly approved by the party responsible for compliance would void the compliance to FCC regulations and therefore, the user's authority to operate the equipment.

Caution! *There is a danger of a new battery exploding if it is incorrectly installed. Do not attempt to recharge, force open, or heat the battery. Replace the battery only with the same or equivalent type recommended by the manufacturer. Discard used batteries according to the manufacturer's instructions.*



Memory Compatibility

AIMB-213N Memory Compatibility list

Brand	Size	Speed	Vendor PN	Advantech PN	Memory
Transcend	1GB	DDR3 1066	TS128MSK64V1U/ TS2KSU28200-1S	96SD3-1G1066NN-TR	PASS
	1GB	DDR3 1066	TS128MSK64V1U	96SD3-1G1066NN-TR	PASS
	2GB	DDR3 1066	TS256MSK64V1U/ TS5KSU28400-1S	96SD3-2G1066NN-TR	PASS
	2GB	DDR3 1066	TS128MSK64V1U	96SD3-2G1066NN-TR	PASS
Apacer	1GB	DDR3 1066	78.02GC3.420	96SD3-1G1066NN-AP	PASS
	2GB	DDR3 1066	78.A2GC3.421	96SD3-2G1066NN-AP	PASS
Kingston	2GB	DDR3 1066	KVR1066D3S7/2G		PASS
DSL	1GB	DDR3 1066			PASS
Micron	1GB	DDR3 1066	MT8JSF12864HZ- 1G1F1		PASS
Samsung	2GB	DDR3 1066	M471B5673DH1-CF8		PASS
Transcend	1GB	DDR3 1333	TS128MSK64V3U		PASS
	2GB	DDR3 1333	TS256MSK64V3U		PASS
Apacer	1GB	DDR3 1333	78.02GC6.420		PASS
	2GB	DDR3 1333	78.A2GC6.421		PASS
DSL	1GB	DDR3 1333	D3SE28081XH15AA	96SD3-1G1333NN-AP	PASS
	2GB	DDR3 1333	D3SE28082XH15AA	96SD3-2G1333NN-AP	PASS
Kingston	1GB	DDR3 1333	KVR1333D3S9/1G		PASS
	2GB	DDR3 1333	KVR1333D3S9/2G		PASS

AIMB-213D Memory Compatibility list

Brand	Size	Speed	Vendor PN	Advantech PN	Memory
Transcend	1GB	DDR3 1066	TS128MSK64V1U/ TS2KSU28200-1S	96SD3-1G1066NN-TR	PASS
	1GB	DDR3 1066	TS128MSK64V1U	96SD3-1G1066NN-TR	PASS
	2GB	DDR3 1066	TS256MSK64V1U/ TS5KSU28400-1S	96SD3-2G1066NN-TR	PASS
	2GB	DDR3 1066	TS128MSK64V1U	96SD3-2G1066NN-TR	PASS
Apacer	1GB	DDR3 1066	78.02GC3.420	96SD3-1G1066NN-AP	PASS
	2GB	DDR3 1066	78.A2GC3.421	96SD3-2G1066NN-AP	PASS
Kingston	2GB	DDR3 1066	KVR1066D3S7/2G		PASS
DSL	1GB	DDR3 1066			PASS
Micron	1GB	DDR3 1066	MT8JSF12864HZ- 1G1F1		PASS
Samsung	2GB	DDR3 1066	M471B5673DH1-CF8		PASS
G.SKILL	4GB	DDR3 1066	F3-8500CL7S-4GBSQ		PASS
Transcend	1GB	DDR3 1333	TS128MSK64V3U		PASS
	2GB	DDR3 1333	TS256MSK64V3U		PASS
Apacer	1GB	DDR3 1333	78.02GC6.420		PASS
	2GB	DDR3 1333	78.A2GC6.421		PASS
DSL	1GB	DDR3 1333	D3SE28081XH15AA	96SD3-1G1333NN-AP	PASS
	2GB	DDR3 1333	D3SE28082XH15AA	96SD3-2G1333NN-AP	PASS
Kingston	1GB	DDR3 1333	KVR1333D3S9/1G		PASS
	2GB	DDR3 1333	KVR1333D3S9/2G		PASS
Transcend	4GB	DDR3 1066	TS7KSN28420-1Y	96SD3-4G1066NN-TR	PASS
Apacer	4GB	DDR3 1066	78.B2GC8.AF1	96SD3-4G1066NN-AP	PASS
DSL	4GB	DDR3 1066	D3SH56082XH18AB		PASS
Transcend	4GB	DDR3 1333	TS512MSK64V3N		PASS
Apacer	4GB	DDR3 1333	78.B2GC9.AF1		PASS
DSL	4GB	DDR3 1333	D3SH56082XH15AA		PASS
ATP	4GB	DDR3 1333	AW12M64F8BKH9S		PASS

Ordering Information

Part Number	CPU	SC/DC	GbE	COM	LVDS
AIMB-213N-S6A1E	Atom N455	Single core	2	6	1, 28/24-bit
AIMB-213D-S6A1E	Atom D525	Dual core	2	6	1, 28/24-bit

Product Warranty (2 years)

Advantech warrants to you, the original purchaser, that each of its products will be free from defects in materials and workmanship for two years from the date of purchase.

This warranty does not apply to any products which have been repaired or altered by persons other than repair personnel authorized by Advantech, or which have been subject to misuse, abuse, accident or improper installation. Advantech assumes no liability under the terms of this warranty as a consequence of such events.

Because of Advantech's high quality-control standards and rigorous testing, most of our customers never need to use our repair service. If an Advantech product is defective, it will be repaired or replaced at no charge during the warranty period. For out-of-warranty repairs, you will be billed according to the cost of replacement materials, service time and freight. Please consult your dealer for more details.

If you think you have a defective product, follow these steps:

1. Collect all the information about the problem encountered. (For example, CPU speed, Advantech products used, other hardware and software used, etc.) Note anything abnormal and list any onscreen messages you get when the problem occurs.
2. Call your dealer and describe the problem. Please have your manual, product, and any helpful information readily available.
3. If your product is diagnosed as defective, obtain an RMA (return merchandise authorization) number from your dealer. This allows us to process your return more quickly.
4. Carefully pack the defective product, a fully-completed Repair and Replacement Order Card and a photocopy proof of purchase date (such as your sales receipt) in a shippable container. A product returned without proof of the purchase date is not eligible for warranty service.
5. Write the RMA number visibly on the outside of the package and ship it prepaid to your dealer.

Initial Inspection

Before you begin installing your motherboard, please make sure that the following materials have been shipped:

- 1 x AIMB-213 Intel® Atom™ N455/D525 Mini-ITX motherboard
- 3 x SATA HDD cable
- 3 x SATA Power cable
- 1 x Serial port cable(1 to 4)
- 1 x I/O port bracket
- 1 x Startup manual
- 1 x Driver CD
- 1 x Warranty card
- 1 x CPU cooler (for Atom D525 only)

If any of these items are missing or damaged, contact your distributor or sales representative immediately. We have carefully inspected the AIMB-213 mechanically and electrically before shipment. It should be free of marks and scratches and in perfect working order upon receipt. As you unpack the AIMB-213, check it for signs of shipping damage. (For example, damaged box, scratches, dents, etc.) If it is damaged or it fails to meet the specifications, notify our service department or your local sales representative immediately. Also notify the carrier. Retain the shipping carton and packing material for inspection by the carrier. After inspection, we will make arrangements to repair or replace the unit.

Contents

Chapter 1	General Information	1
1.1	Introduction	2
1.2	Features	2
1.3	Specifications	3
1.3.1	System	3
1.3.2	Memory	3
1.3.3	Input/Output	3
1.3.4	Graphics	3
1.3.5	Ethernet LAN	3
1.3.6	Industrial features	3
1.3.7	Mechanical and environmental specifications	4
1.4	Jumpers and Connectors	4
	Table 1.1: Jumpers	4
	Table 1.2: Connectors	4
1.5	Board layout: Jumper and Connector Locations	6
	Figure 1.1 Jumper and Connector Location	6
	Figure 1.2 I/O Connectors	6
1.6	AIMB-213 Board Diagram	7
	Figure 1.3 AIMB-213 Board Diagram	7
1.7	Safety Precautions	8
1.8	Jumper Settings	9
1.8.1	How to Set Jumpers	9
1.8.2	CMOS Clear (CMOS1)	9
	Table 1.3: CMOS1	9
1.8.3	COM2 RS 232/422/485 Mode Selector (JSETCOM2)	10
	Table 1.4: COM2 RS 232/422/485 Mode Selector (JSETCOM2)	10
1.8.4	JLVDS1 and JLVDS2: LCD Power 3.3 V/5 V/ 12 V Selector	10
	Table 1.5: JLVDS1 and JLVDS2: LCD Power 3.3 V/5 V/ 12 V Selector	10
1.8.5	PSON1: ATX, AT Mode Selector	11
	Table 1.6: PSON1: ATX, AT Mode Selector	11
1.8.6	JWDT1: Watchdog Timer Output Option	11
	Table 1.7: JWDT1: Watchdog Timer Output Option	11
1.9	System Memory	12
1.10	Memory Installation Procedures	12
Chapter 2	Connecting Peripherals	13
2.1	Introduction	14
2.2	USB Ports (LAN1_USB12/LAN2_USB34/USB56/USB78)	14
	Table 2.1: LAN LED Indicator	14
2.3	VGA Connector (VGA1)	15
2.4	Serial Ports (COM1~COM6)	16
2.5	PS/2 Keyboard and Mouse Connector (KBMS1)	17
2.6	CPU Fan Connector (CPU_FAN1)	17
2.7	System FAN Connector (SYSFAN1)	18
2.8	Front Panel Connectors (JFP1/JFP1+JFP2)	19
2.8.1	ATX soft power switch ((JFP1+JFP2/ PWR_SW))	19
2.8.2	Reset (JFP1+JFP2/ RESET)	19
2.8.3	HDD LED (JFP1+JFP2/ HDDLED)	19
2.8.4	External speaker (JFP1+JFP2/ SPEAKER)	19
2.8.5	Power LED and keyboard lock connector (JFP1 / PWR_LED & KEY LOCK)	20

Table 2.2: ATX power supply LED status (No support for AT power)

2.9	Line In, Line Out, Mic In Connector (AUDIO1).....	20
2.10	Serial ATA Interface (SATA1/2/3).....	21
2.11	PCI.....	21
2.12	Front Headphone Connector (HD1).....	22
2.13	ATX 12V Power Connector (ATX12V_1).....	23
2.14	SPI Flash connector(SPI_CN1).....	23
2.15	LCD Inverter Connector (INV1).....	24
2.16	LVDS Connector (LVDS1).....	25
2.17	General purpose I/O Connector (GPIO1).....	25

Chapter 3 BIOS Operation 27

3.1	Introduction.....	28
3.2	BIOS Setup.....	28
3.2.1	Main Menu.....	29
3.2.2	Advanced BIOS Features.....	30
3.2.3	Advanced PCI/PnP Settings.....	40
3.2.4	Boot Settings.....	42
3.2.5	Security Setup.....	43
3.2.6	Advanced Chipset Settings.....	44
3.2.7	Exit Option.....	47

Chapter 4 Software Introduction & Service 49

4.1	Introduction.....	50
4.2	Value-Added Software Services.....	50
4.2.1	Software API.....	50
4.2.2	Software Utility.....	52

Chapter 5 Chipset Software Installation Utility 53

5.1	Before You Begin.....	54
5.2	Introduction.....	54
5.3	Windows XP Driver Setup.....	55

Chapter 6 VGA Setup 57

6.1	Introduction.....	58
6.2	Windows 7/Vista/XP.....	58

Chapter 7 LAN Configuration 59

7.1	Introduction.....	60
7.2	Features.....	60
7.3	Installation.....	60
7.4	Windows 7/Vista/XP Driver Setup (Intel 82567v/82583v).....	61

Appendix A Programming the Watchdog Timer . 63

A.1	Programming the Watchdog Timer.....	64
A.1.1	Watchdog Timer Overview.....	64
A.1.2	Programming the Watchdog Timer.....	64
	Table A.1: Watchdog Timer Registers.....	66

Appendix B I/O Pin Assignments.....71

B.1	USB Header (USB56, USB78).....	72
	Table B.1: USB Header (USB56).....	72
B.2	VGA Connector (VGA1).....	72
	Table B.2: VGA Connector (VGA1)	72
B.3	RS-232 Interface (COM3/4/5/6)	73
	Table B.3: RS-232 Interface (COM3~COM6)	73
B.4	RS-232/422/485 Setting Interface (JSETCOM2)	74
	Table B.4: RS-232/422/485 Setting Interface (JSETCOM2).....	74
B.5	SPI_CN1: SPI Fresh Card Pin Connector.....	74
	Table B.5: SPI_CN1:SPI Fresh Card Pin Connector	74
B.6	PS/2 Keyboard and Mouse Connector (KBMS1).....	75
	Table B.6: PS/2 Keyboard and Mouse Connector (KBMS1)	75
B.7	CPU Fan Power Connector (CPU_FAN1)	75
	Table B.7: CPU Fan Power Connector (CPU_FAN1).....	75
B.8	System Fan Power Connector (CHA_FAN1).....	75
	Table B.8: System Fan Power Connector (SYSFAN1/SYSFAN2)	75
B.9	Power LED & Keyboard Lock Connector (JFP1)	76
	Table B.9: Power LED & Keyboard Lock Connector (JFP1).....	76
B.10	Power switch/HDD LED/SMBus/Speaker (JFP1+JFP2).....	76
	Table B.10:Power Switch/HDD LED/SMBus/Speaker (JFP1+JFP2)	76
B.11	USB/LAN ports (LAN1_USB12/LAN2_USB34).....	77
	Table B.11:USB Port.....	77
	Table B.12:Ethernet 10/100 Mbps RJ-45 Port	77
B.12	Line In, Line Out, Mic In Connector (AUDIO1).....	77
B.13	Serial ATA0/1 (SATA1/2/3)	77
	Table B.13:Serial ATA 0/1 (SATA1/2/3).....	77
B.14	AT/ATX Mode (PSON1)	78
	Table B.14:AT/ATX Mode (PSON1)	78
B.15	HD Audio Interface (HD1)	78
	Table B.15:AC-97 Audio Interface (HD1).....	78
B.16	GPIO Pin Header (GPIO1).....	78
	Table B.16:GPIO Pin Header (GPIO1)	78
B.17	LVDS Connector: LVDS1	79
	Table B.17:LVDS1 Connector.....	79
B.18	LVDS Power Jumper (JLVDS1 and JLVDS2).....	80
	Table B.18:LVDS Power Jumper	80
B.19	LVDS Inverter (INV1)	80
	Table B.19:LVDS Power Jumper	80
B.20	ATX 12 V connector (ATX12V_1)	80
	Table B.20:ATX 12 V connector (ATX12V_1).....	80
B.21	DMA Channel Assignments	81
	Table B.21:DMA Channel Assignments.....	81
B.22	Interrupt Assignments	81
	Table B.22:Interrupt Assignments.....	81
B.23	1st MB Memory Map	81
	Table B.23:1st MB Memory Map	81

Chapter 1

General Information

1.1 Introduction

The AIMB-213 is designed with the Intel® Atom™ N455/D525 and the ICH8M for industrial applications that require both performance computing and enhanced power management capabilities. The motherboard has on board CPU Intel® Atom™ N455/D525 1.66/1.8 GHz and DDR3 800 MHz up to 2/4 GB.

The AIMB-213 offers cost-saving integrated graphics, built on the Intel® N455/D525 chipset and features the unique Intel® Extreme Graphics architecture that maximizes VGA performance and shares system memory up to 224 MB.

Advantech AIMB-213 is designed with an Intel® ICH8M and on board CPU Intel® ATOM™ N455/D525 1.66/1.8 GHz processor. A rich I/O connectivity of 6 serial ports, 8 USB 2.0, Dual GbE LAN and 3 SATA ports.

1.2 Features

- **Rich I/O connectivity:** 6 serial ports, 8 USB 2.0, Dual GbE LAN
- **Standard Mini-ITX form factor with industrial feature:** The AIMB-213 is a full-featured Mini-ITX motherboard with balanced expandability and performance
- **Wide selection of storage devices:** SATA HDD, CF, customers benefit from the flexibility of using the most suitable storage device for larger capacity
- **Optimized integrated graphic solution:** With Intel® Embedded Gen3.5+ GFX Core, 200/400-MHz render clock frequency for N455/D525

1.3 Specifications

1.3.1 System

- **CPU:** Intel® Atom™ N455/D525
- **BIOS:** Award SPI 16 Mbit BIOS
- **System chipset:** Intel® ICH8M
- **SATA hard disk drive interface:** Three on-board SATA connectors with data transmission rate up to 300 MB
- **CF interface:** Supports compact flash Type II

1.3.2 Memory

- **RAM:** Up to 2 GB/ 4GB in 2 slots 204-pin SODIMM sockets. Supports single channel DDR3 800 SDRAM

1.3.3 Input/Output

- **PCI bus:** 1 PCI slot
- **Serial ports:** Six serial ports, COM2 is RS-232/422/485 and five of RS-232 serial ports
- **Keyboard and PS/2 mouse connector:** Supports one standard PS/2 keyboard, one standard PS/2 mouse (On board 6pin wafer box)
- **USB port:** Supports up to eight USB 2.0 ports with transmission rate up to 480 Mbps, 4 on board pin header and 4 external ports)
- **GPIO connector:** 8-bit general purpose Input/Output

1.3.4 Graphics

- **Controller:** Embedded Gen3.5+ GFX Core, 200/400-MHz render clock frequency for N455/D525
- **Display memory:** Dynamically shared system memory up to 224 MB
- **VGA:** Support resolution up to SXGA 1400 x 1050 pixels, 32bits, 60Hz refresh rate for Atom N455, supports resolutions up to 2048 x 1536 @ 60 Hz for Atom D525
- **LVDS:** Supports 18/24-bit single channel and up to WXGA 1366 x 768
- **DVI:** Supports up to UXGA 1600 x 1200 @ 60Hz

1.3.5 Ethernet LAN

- Supports dual 10/100/1000 Mbps Ethernet port (s) via PCI Express x1 bus which provides 500 MB/s data transmission rate
- **Controller:** LAN1: Intel 82567v; LAN2: Intel 82583v

1.3.6 Industrial features

- **Watchdog timer:** Can generate a system reset. The watchdog timer is programmable, with each unit equal to one second or one minute (255 levels)

1.3.7 Mechanical and environmental specifications

- **Operating temperature:** 0 ~ 60° C (32 ~ 140° F, Depending on CPU)
- **Storage temperature:** -40 ~ 85° C (-40 ~ 185° F)
- **Humidity:** 5 ~ 95% non-condensing
- **Power supply voltage:** +12 V
- **Power consumption:**
AIMB-213N sku +12 V @ 3.09 A
AIMB-213D sku +12 V @ 3.43 A
Measure of the maximum current values with system under maximum load
- **Board size:** 170 mm x 170 mm (6.69" x 6.69")
- **Board weight:** 0.365 kg

1.4 Jumpers and Connectors

Connectors on the AIMB-213 motherboard link it to external devices such as hard disk drives and a keyboard. In addition, the board has a number of jumpers used to configure your system for your application.

The tables below list the function of each of the board jumpers and connectors. Later sections in this chapter give instructions on setting jumpers. Chapter 2 gives instructions for connecting external devices to your motherboard.

Table 1.1: Jumpers

Label	Function
JFP1	Power LED and Keyboard lock
JFP1+JFP2	Power Switch/Reset Switch/HDD LED/SM Bus/Speaker
CMOS1	CMOS clear (Default 1-2)
JLVDS1	Voltage 3.3 V / 5 V selector for LVDS1 connector (Default 1-2, 3.3 V)
JLVDS2	Voltage 12 V selector for LVDS1 connector
PSON1	AT(1-2) / ATX(2-3), (Default 2-3)
JSETCOM2	COM2 RS232/422/485 Jumper Setting
JWDT1	Watchdog Reset
JOBS1	H/W Monitor Alarm

Table 1.2: Connectors

Label	Function
USB56	USB port 5, 6 (on board)
USB78	USB port 7, 8 (on board)
VGA1+DVI1	VGA/DVI connector
COM12	Serial port: COM1 (RS232) and COM2 (RS232, RS422 and RS485)
COM3456	Serial port connector:(RS232)
KBMS1	Internal PS/2 Keyboard and Mouse connector
CPUFAN1	CPU FAN connector(3-pin)
SYSFAN1	System FAN connector(3-pin)
LAN1_USB12	LAN1 / USB port 1, 2
LAN2_USB34	LAN2 / USB port 3, 4
CF1	CF Socket

Table 1.2: Connectors

AUDIO1	Audio connector
HD1	HD Audio Front Panel Pin Header
GPIO1	GPIO Header
DC_JACK1	DC 12 V connector
INV1	LVDS1 Inverter Power
LVDS1	LVDS1 connector (Internal)
PCI1	PCI Slot
SATA1	Serial ATA data connector 1
SATA2	Serial ATA data connector 2
SATA3	Serial ATA data connector 3
SATA_PWR_CN1	Serial ATA power connector 1
SATA_PWR_CN2	Serial ATA power connector 2
SATA_PWR_CN3	Serial ATA power connector 3
DIMM1	Memory connector channel
DIMM2	Memory connector channel
SPI_CN1	SPI flash update connector
MINIPCI1	Mini PCI express connector
ATX12V_1	ATX 12 V connector
JSETCOM6	COM6 support 5V/12V Jumper Setting
JVBR1	Brightness control selector for Analog or Digital (Default 1-2, Analog)

1.5 Board layout: Jumper and Connector Locations

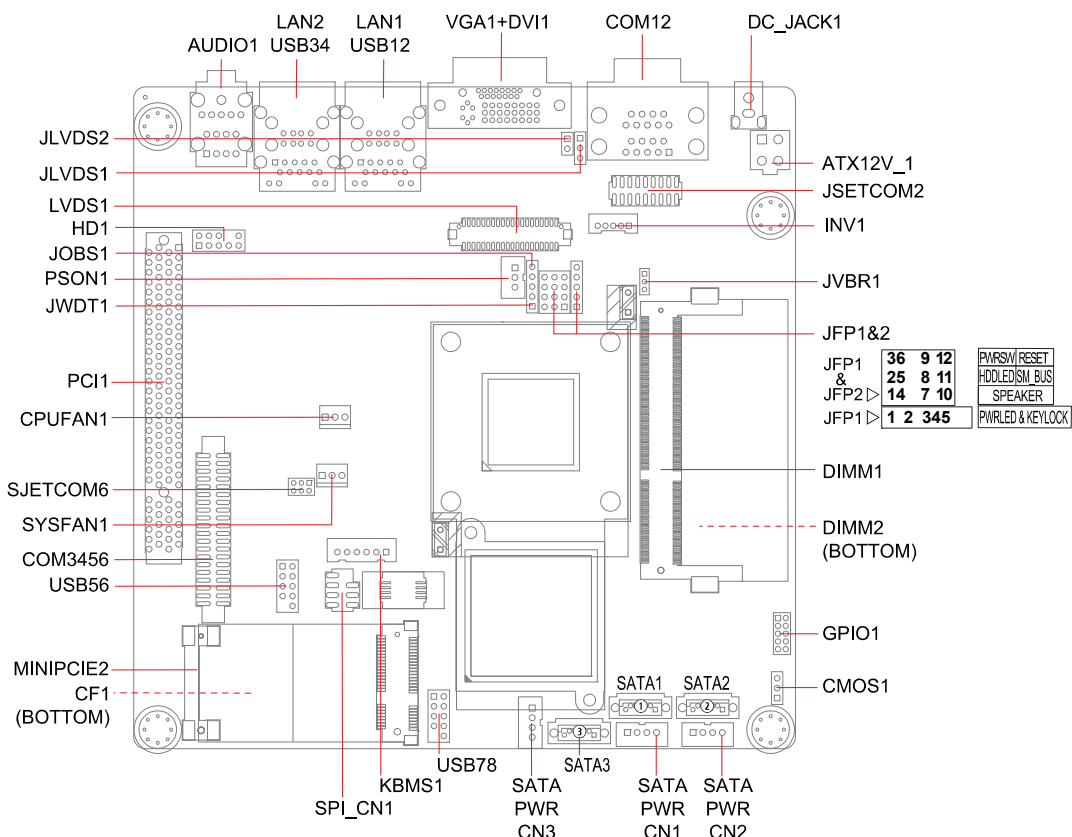

Figure 1.1 Jumper and Connector Location



Figure 1.2 I/O Connectors

1.6 AIMB-213 Board Diagram

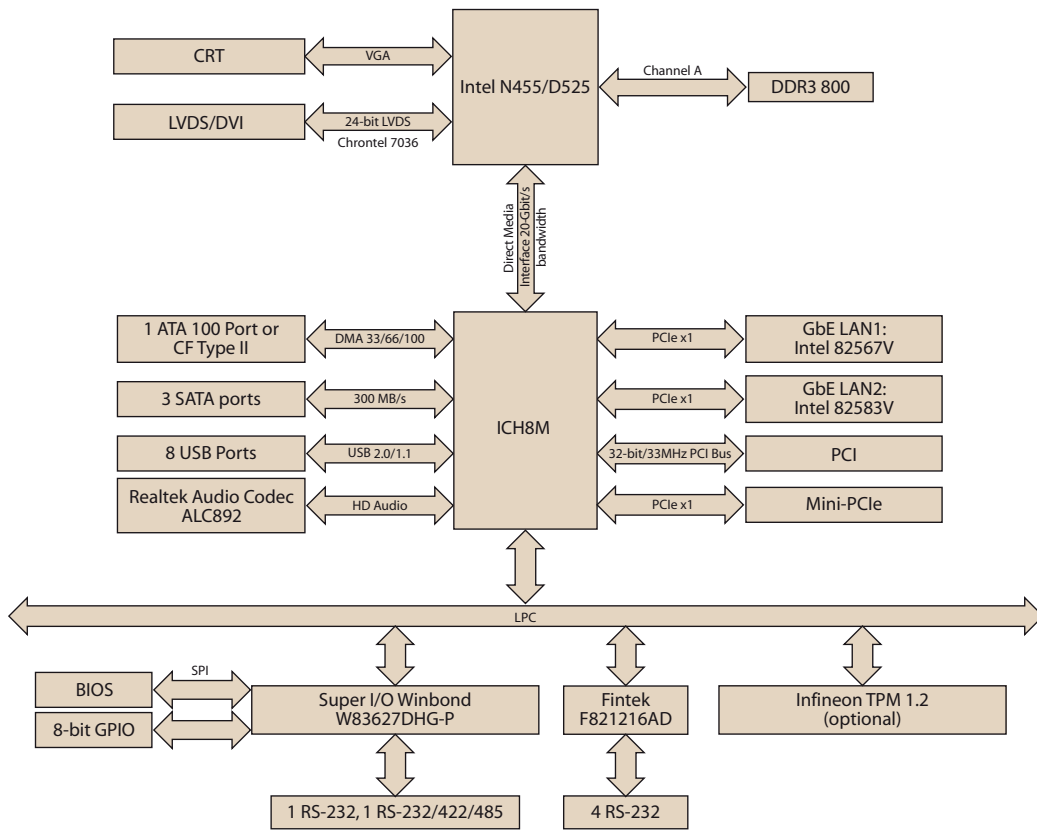

Figure 1.3 AIMB-213 Board Diagram

1.7 Safety Precautions

Warning! *Always completely disconnect the power cord from chassis whenever you work with the hardware. Do not make connections while the power is on. Sensitive electronic components can be damaged by sudden power surges. Only experienced electronics personnel should open the PC chassis.*



Caution! *Always ground yourself to remove any static charge before touching the motherboard. Modern electronic devices are very sensitive to electrostatic discharges. As a safety precaution, use a grounding wrist strap at all times. Place all electronic components on a static-dissipative surface or in a static-shielded bag when they are not in the chassis.*



Caution! *The computer is provided with a battery-powered real-time clock circuit. There is a danger of explosion if battery is incorrectly replaced. Replace only with same or equivalent type recommended by the manufacturer. Discard used batteries according to manufacturer's instructions.*



Caution! *There is a danger of a new battery exploding if it is incorrectly installed. Do not attempt to recharge, force open, or heat the battery. Replace the battery only with the same or equivalent type recommended by the manufacturer. Discard used batteries according to the manufacturer's instructions.*



1.8 Jumper Settings

This section provides instructions on how to configure your motherboard by setting the jumpers. It also includes the motherboards's default settings and your options for each jumper.



1.8.1 How to Set Jumpers

You can configure your motherboard to match the needs of your application by setting the jumpers. A jumper is a metal bridge that closes an electrical circuit. It consists of two metal pins and a small metal clip (often protected by a plastic cover) that slides over the pins to connect them. To “close” (or turn ON) a jumper, you connect the pins with the clip. To “open” (or turn OFF) a jumper, you remove the clip. Sometimes a jumper consists of a set of three pins, labeled 1, 2, and 3. In this case you connect either pins 1 and 2, or 2 and 3. A pair of needle-nose pliers may be useful when setting jumpers.

1.8.2 CMOS Clear (CMOS1)

The AIMB-213 motherboard contains a jumper that can erase CMOS data and reset the system BIOS information. Normally this jumper should be set with pins 1-2 closed. If you want to reset the CMOS data, set J1 to 2-3 closed for just a few seconds, and then move the jumper back to 1-2 closed. This procedure will reset the CMOS to its default setting.

Table 1.3: CMOS1

Function	Jumper Setting
*Keep CMOS data	 1-2 closed
Clear CMOS data	 2-3 closed

* Default

1.8.3 COM2 RS 232/422/485 Mode Selector (JSETCOM2)

Users can use JSETCOM2 to select among RS 232/422/485 modes for COM2. The default setting is RS 232.

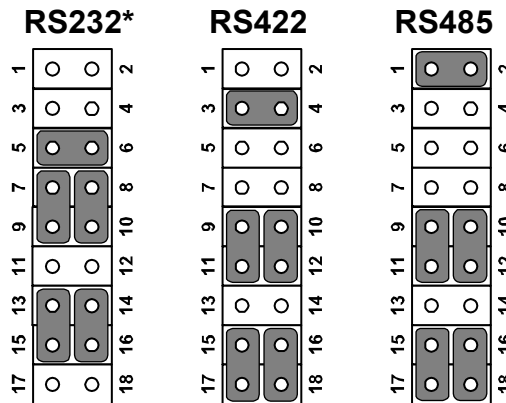

Table 1.4: COM2 RS 232/422/485 Mode Selector (JSETCOM2)

Function	Jumper Setting
*RS232	(5-6) + (7-9) + (8-10) + (13-15) + (14-16) closed
RS422	(3-4) + (9-11) + (10-12) + (15-17) + (16-18) closed
RS-485	(1-2) + (9-11) + (10-12) + (15-17) + (16-18) closed
*: Default	

1.8.4 JLVDS1 and JLVDS2: LCD Power 3.3 V/5 V/ 12 V Selector

Table 1.5: JLVDS1 and JLVDS2: LCD Power 3.3 V/5 V/ 12 V Selector

Closed Pins	Result
JLVDS1	
1-2*	For 3.3 V LVDS Panel
2-3	For 5 V LVDS Panel
JLVDS1 and JLVDS2	
2-2	For 12 V LVDS Panel

*Default

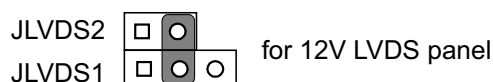
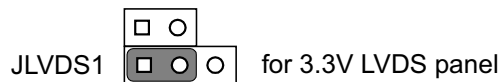

1.8.5 PSON1: ATX, AT Mode Selector

Table 1.6: PSON1: ATX, AT Mode Selector

Closed Pins	Result
1-2	AT Mode
2-3*	ATX Mode

*Default

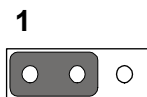

AT Mode
1-2 closed

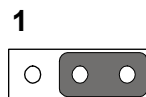

ATX Mode
2-3 closed

1.8.6 JWDT1: Watchdog Timer Output Option

Table 1.7: JWDT1: Watchdog Timer Output Option

Closed Pins	Result
1-2	NC
2-3*	System Reset*

*Default

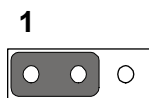

NC
1-2 closed

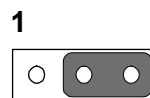

System Reset
2-3 closed

1.9 System Memory

The AIMB-213 has one socket for a 204-pin SODIMMx2.

This socket uses a 1.5 V unbuffered double-data-rate three synchronous DRAM (DDR3 SDRAM). DRAM is available in capacities of 512 MB, 1 GB and 2 GB. The socket can be filled in any combination with DIMMs of any size, giving a total memory size between 512 MB and 4 GB. AIMB-213 does NOT support ECC (error checking and correction).

1.10 Memory Installation Procedures

To install SODIMMs, first make sure the two handles of the SODIMM socket are in the “open” position, i.e., the handles lean outward. Slowly slide the SODIMM module along the plastic guides on both ends of the socket. Then press the SODIMM module well down into the socket, until you hear a click when the two handles have automatically locked the memory module into the correct position of the SODIMM socket. To remove the memory module, just push both handles outward, and the memory module will be ejected by the mechanism.

Chapter 2

Connecting
Peripherals

2.1 Introduction

You can access most of the connectors from the top of the board as it is being installed in the chassis. If you have a number of cards installed or have a packed chassis, you may need to partially remove the card to make all the connections.

2.2 USB Ports (LAN1_USB12/LAN2_USB34/USB56/USB78)

The AIMB-213 provides up to eight USB ports. The USB interface complies with USB Specification Rev. 2.0 supporting transmission rate up to 480 Mbps and is fuse protected. The USB interface can be disabled in the system BIOS setup.

The AIMB-213 is equipped with one high-performance 1000 Mbps Ethernet LAN adapter, and one 100 Mbps LAN adapter, both of which are supported by all major network operating systems. The RJ-45 jacks on the rear panel provide for convenient LAN connection.

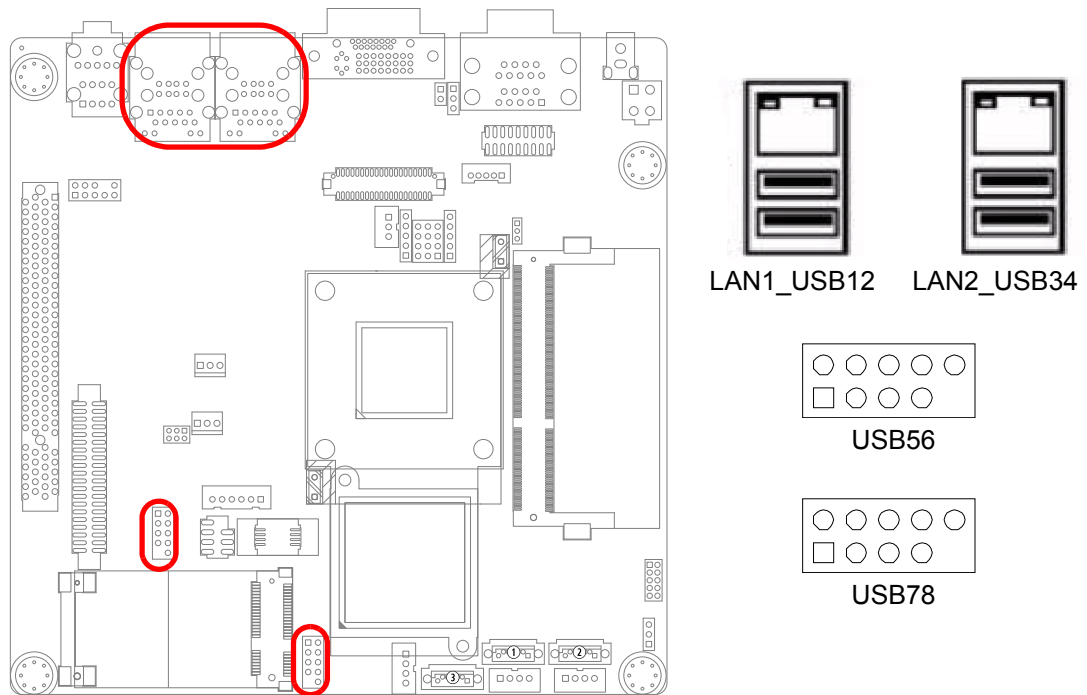
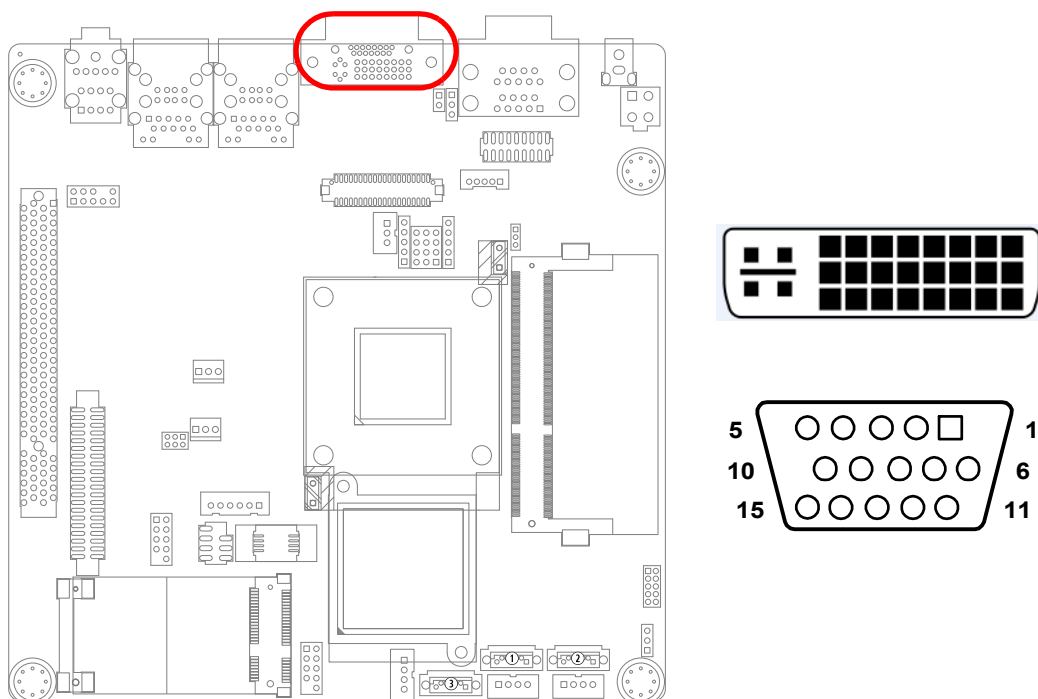

Table 2.1: LAN LED Indicator

LAN Mode	Lan Indicator
1 Gbps Link on	LED1 Green on
100 Mbps Link on	LED1 Orange on
Active	LED2 Green flash

2.3 VGA Connector (VGA1)



The AIMB-213 includes VGA and DVI interface that can drive conventional VGA and DVI displays. VGA1 is a standard 15-pin D-SUB connector commonly used for VGA. DVI1 is DVI-I connector but only for DVI-D single link signals output. Pin assignments for VGA and DVI connector are detailed in Appendix B.

2.4 Serial Ports (COM1~COM6)

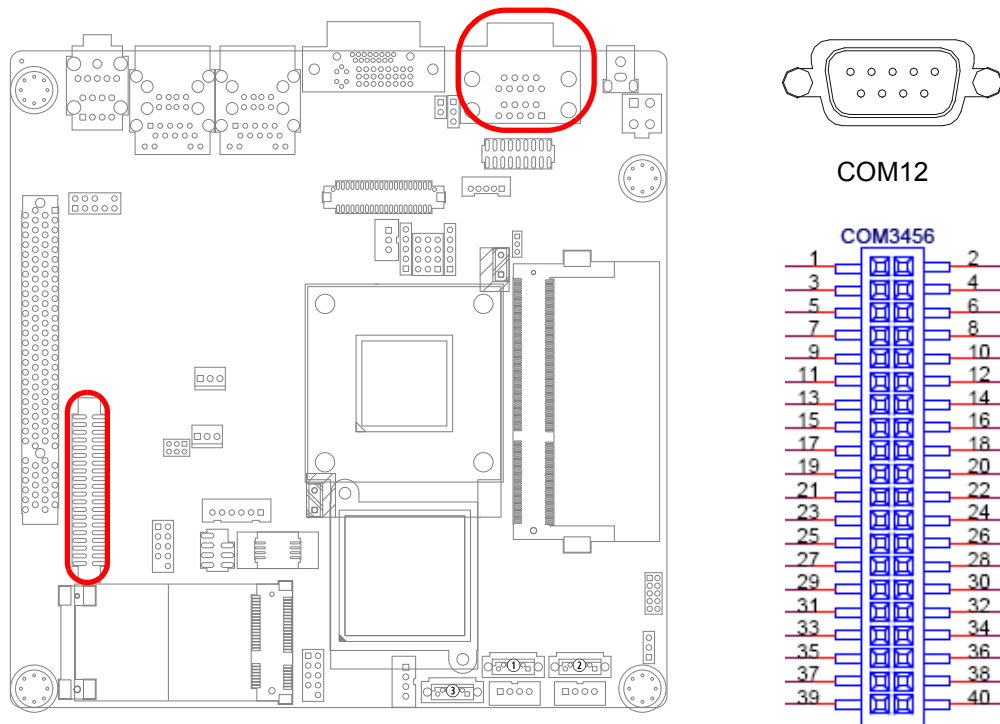

AIMB-213 supports six serial ports. 1 of RS-232/422/485 - COM1, COM2, COM3, COM4, COM5 and COM6. The user can use JSETCOM2 to select among RS 232/422/485 modes for COM2. These ports can connect to serial devices, such as a mouse or a printer, or to a communications network.

The IRQ and address ranges for both ports are fixed. However, if you want to disable the port or change these parameters later, you can do this in the system BIOS setup.

Different devices implement the RS-232/422/485 standards in different ways. If you should happen to have problems with a serial device, be sure to check the pin assignments for the connector.

2.5 PS/2 Keyboard and Mouse Connector (KBMS1)

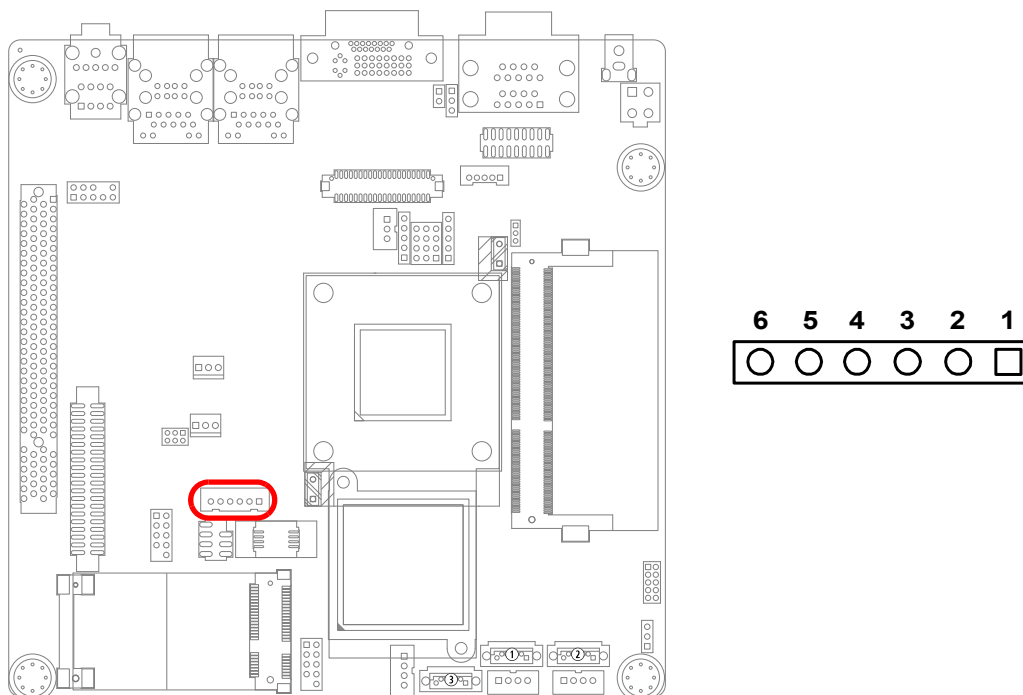

On board 6-pin wafer box connector, supports one standard PS/2 keyboard, one standard PS/2 mouse.

2.6 CPU Fan Connector (CPU_FAN1)

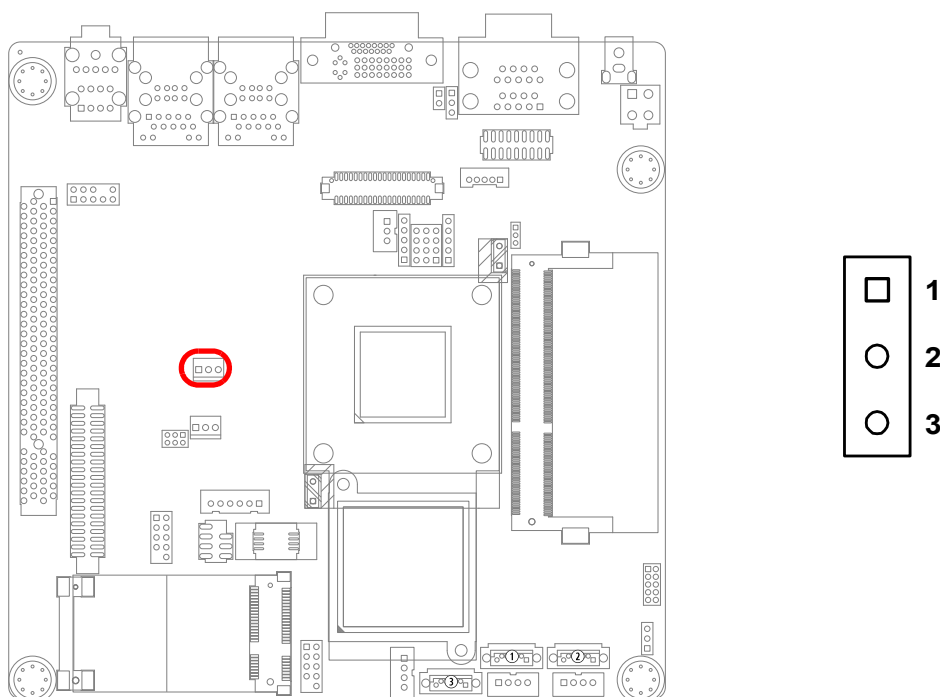

If a fan is used, this connector supports cooling fans of 500 mA (6 W) or less.

2.7 System FAN Connector (SYSFAN1)

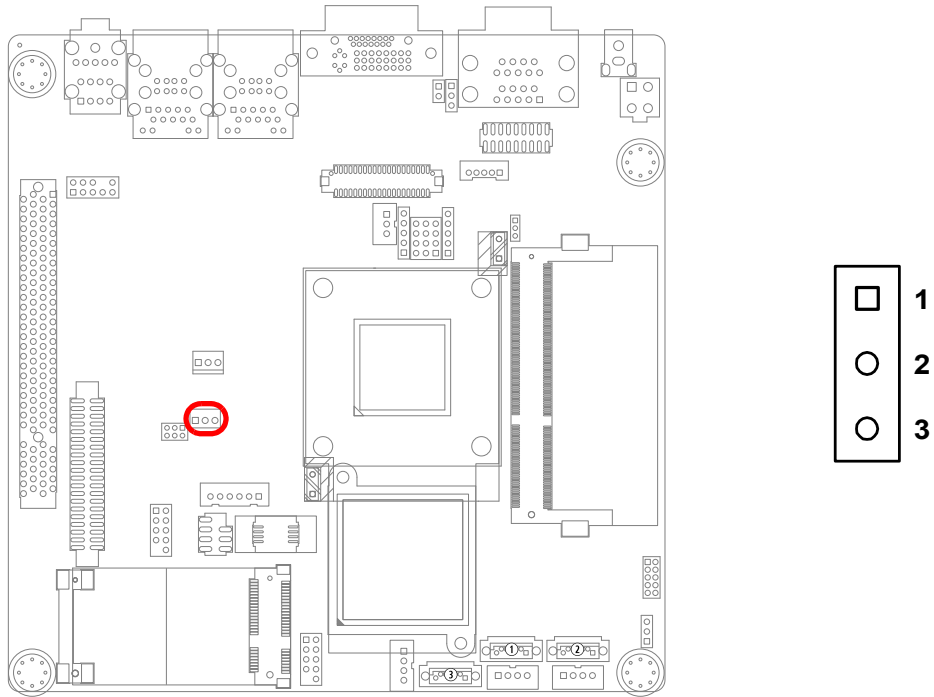

If a fan is used, this connector supports cooling fans of 500 mA (6 W) or less.

2.8 Front Panel Connectors (JFP1/JFP1+JFP2)

There are several external switches to monitor and control the AIMB-213.

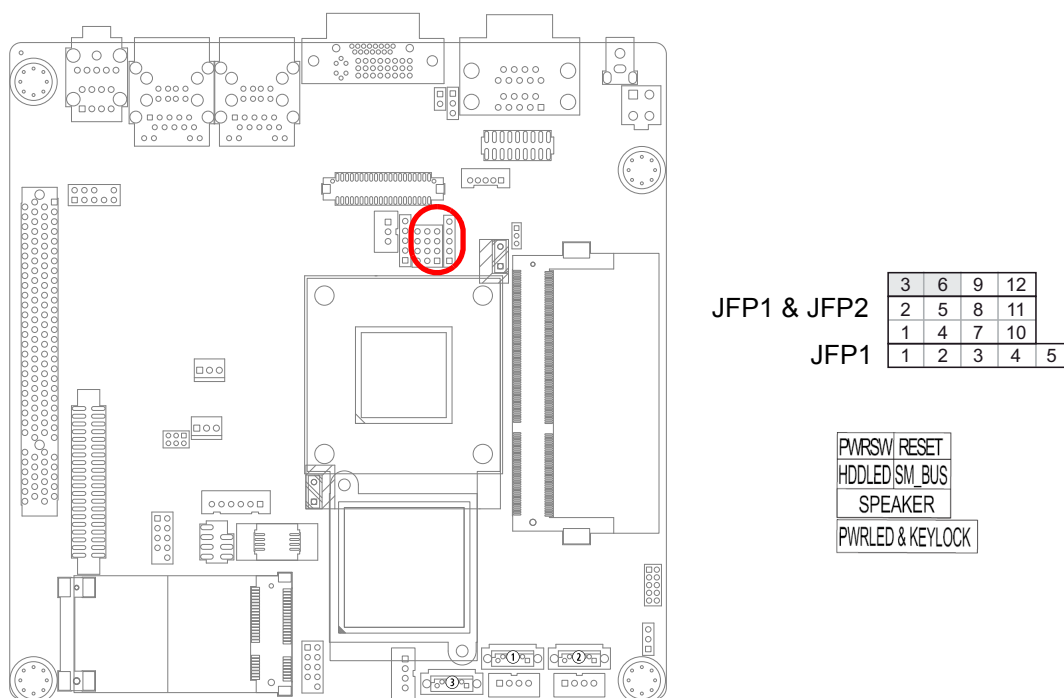

2.8.1 ATX soft power switch ((JFP1+JFP2/ PWR_SW))

If your computer case is equipped with an ATX power supply, you should connect the power on/off button on your computer case to ((JFP1+JFP2/ PWR_SW)), for convenient power on and off.

2.8.2 Reset (JFP1+JFP2/ RESET)

Many computer cases offer the convenience of a reset button. Connect the wire for the reset button.

2.8.3 HDD LED (JFP1+JFP2/ HDDLED)

You can connect an LED to connector (JFP2/HDDLED) to indicate when the HDD is active.

2.8.4 External speaker (JFP1+JFP2/ SPEAKER)

((JFP1+JFP2/ SPEAKER)) is a 4-pin connector for an external speaker. If there is no external speaker, the AIMB-213 provides an onboard buzzer as an alternative. To enable the buzzer, set pins 7-10 as closed.

2.8.5 Power LED and keyboard lock connector (JFP1 / PWR_LED & KEY LOCK)

(JFP1 / PWR_LED & KEY LOCK) is a 5-pin connector for the power on LED and Key Lock function. Refer to Appendix B for detailed information on the pin assignments. The Power LED cable should be connected to pin 1-3. The key lock button cable should be connected to pin 4-5.

There are 3 modes for the power supply connection. The first is “ATX power mode”; the system turns on/off by a momentary power button. The second is “AT Power Mode”; the system turns on/off via the power supply switch. The third is another “AT Power Mode” which makes use of the front panel power switch. The power LED status is indicated in the following table:

Table 2.2: ATX power supply LED status (No support for AT power)

Power mode	LED (ATX Power Mode) (On/off by momentary button)	LED (AT power Mode) (On/off by switching power supply)	LED (AT power Mode) (On/off by front panel switch)
PSOEN1 (on back plane) jumper setting	pins 2-3 closed	pins 1-2 closed	Connect pins 1 & 2 to panel switch via cable
System On	On	On	On
System Suspend	Fast flashes	Fast flashes	Fast flashes
System Off	Slow flashes	Off	Off

2.9 Line In, Line Out, Mic In Connector (AUDIO1)

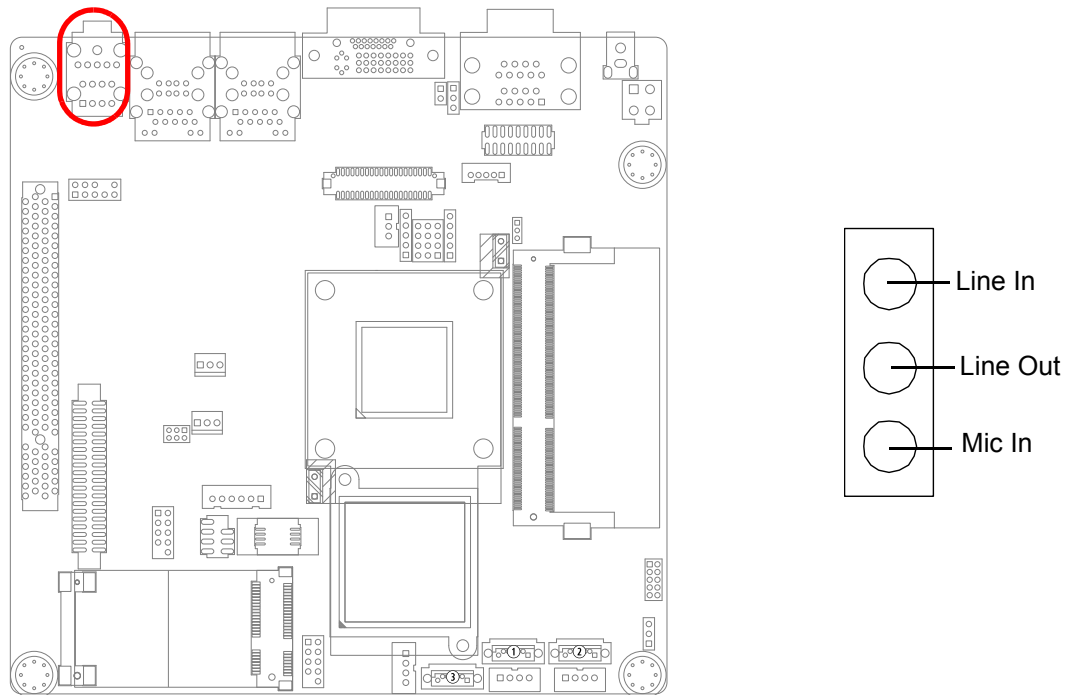

2.10 Serial ATA Interface (SATA1/2/3)

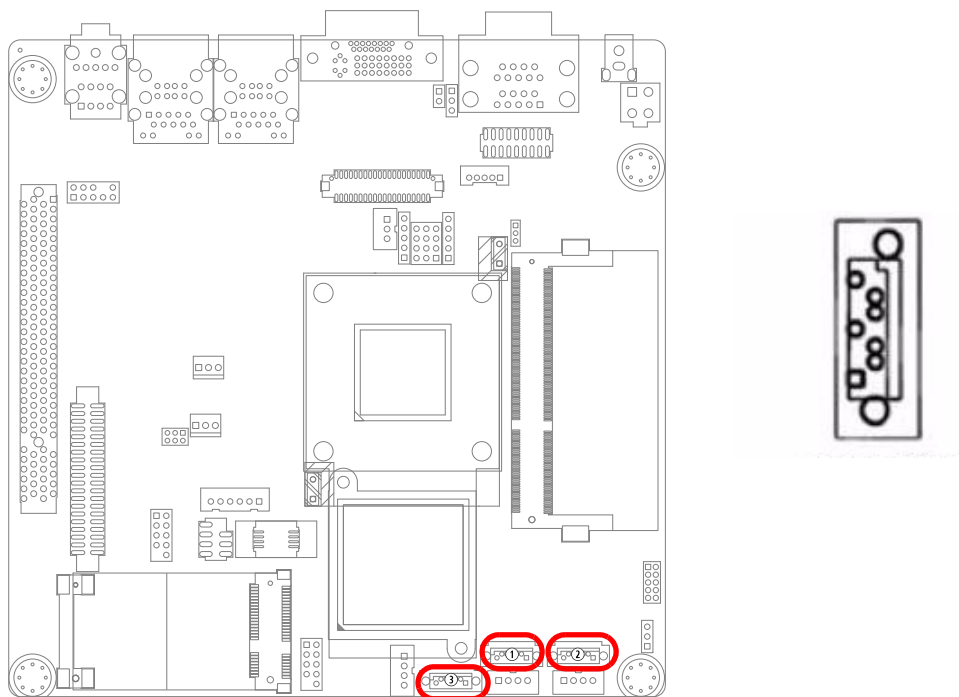

AIMB-213 features a high performance Serial ATA interface (up to 300 MB/s) which eases cabling to hard drives with long, thin cables.

2.11 PCI

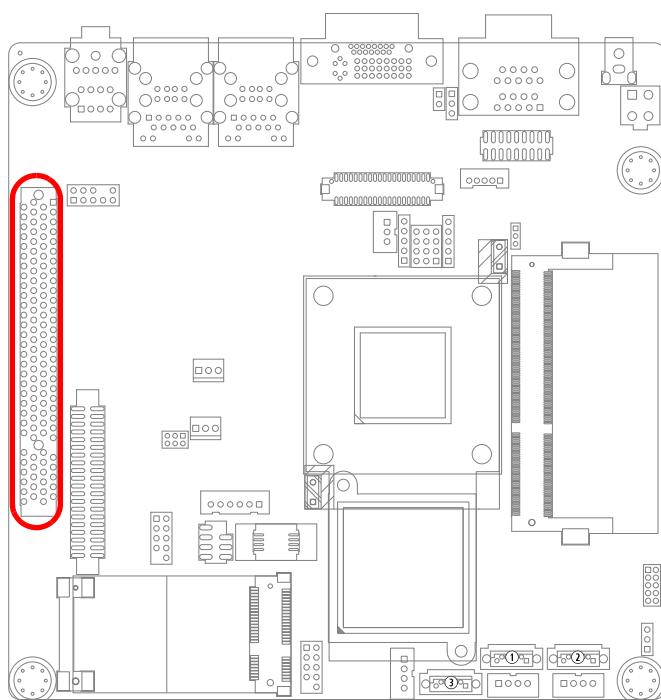

The AIMB-213 provides 1 x PCI slot.

2.12 Front Headphone Connector (HD1)

This connector is for a chassis-mounted front panel audio I/O module that supports either HD Audio or legacy AC'97 (optional) audio standard. Connect this connector with the front panel audio I/O module cable.

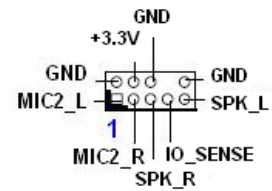
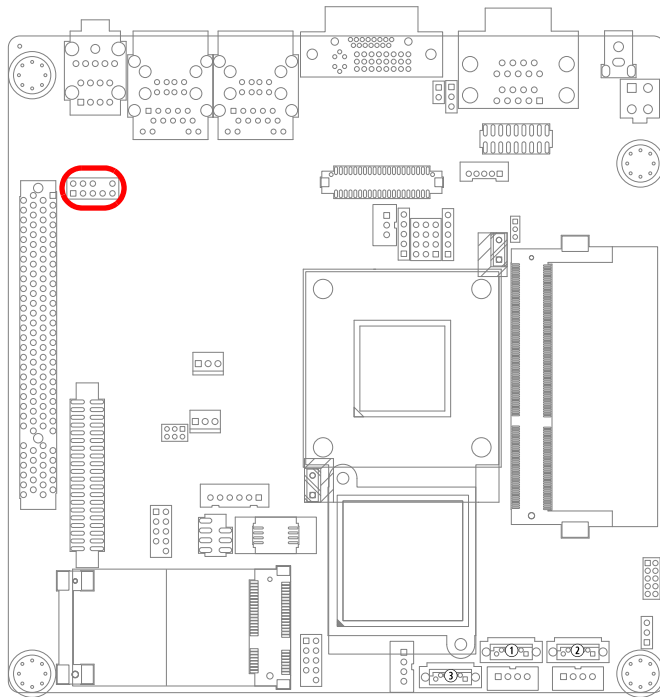

Note!  For motherboards with the optional HD Audio feature, we recommend that you connect a high-definition front panel audio module to this connector to take advantage of the motherboard's high definition audio capability.

2.13 ATX 12V Power Connector (ATX12V_1)

This connector is for an ATX Micro-Fit power supply. The plugs from the power supply are designed to fit these connectors in only one direction. Determine the proper orientation and push down firmly until the connectors mate completely.

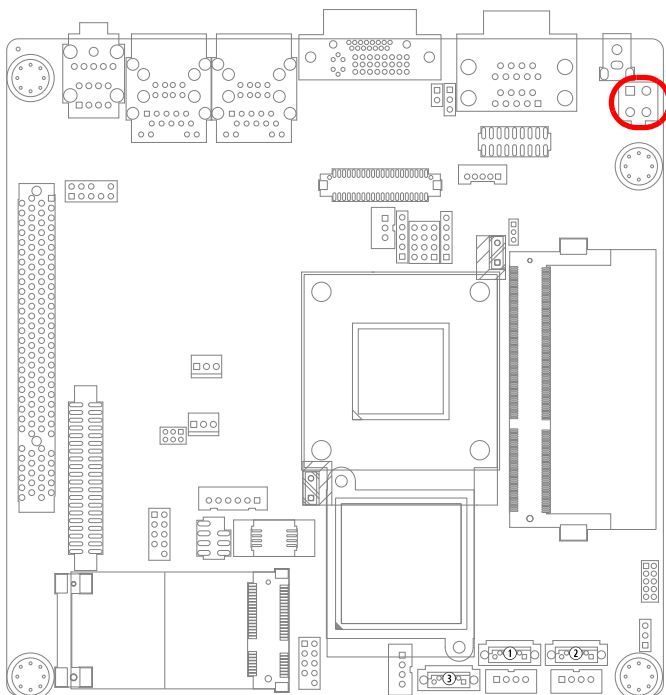

2.14 SPI Flash connector(SPI_CN1)

The SPI flash card pin header may be used to flash BIOS if the AIMB-213 cannot power on.

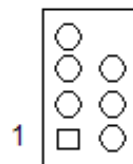
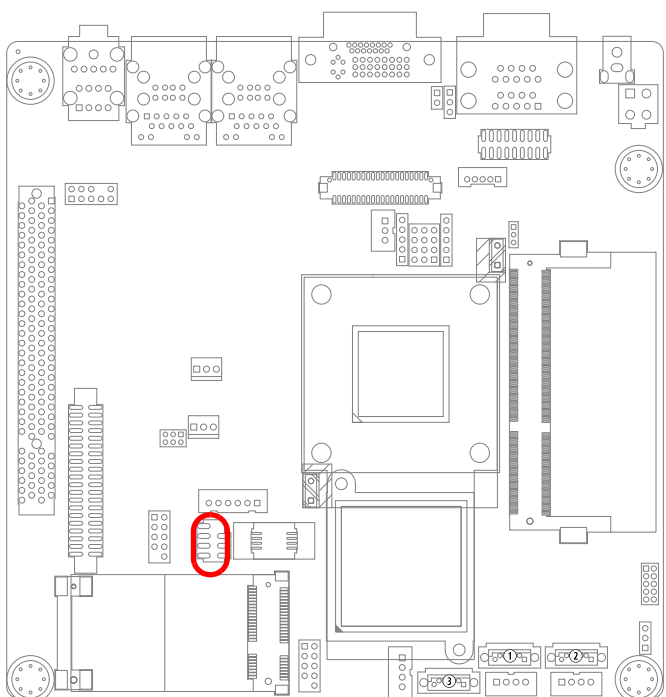

2.15 LCD Inverter Connector (INV1)

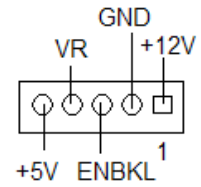
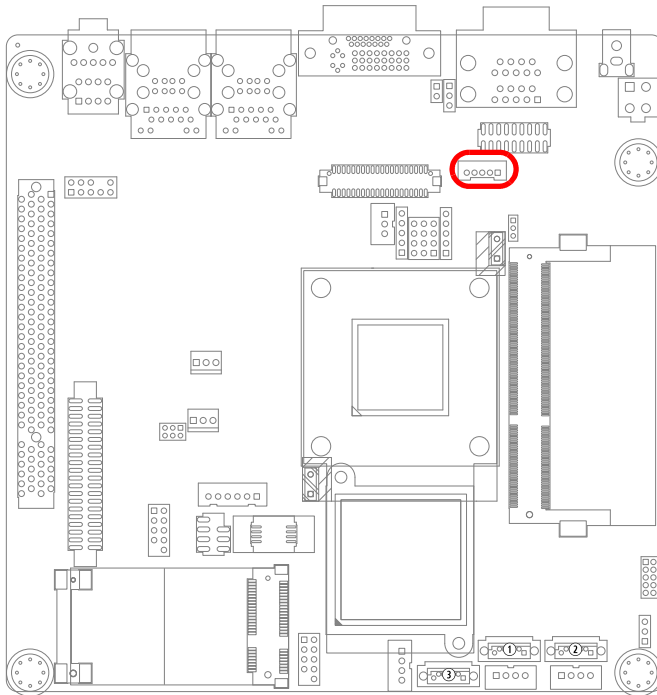

Note! ■ **Signal Description**



Signal

VR

ENBK1

Signal Description

$V_{adj}=0.75\text{ V}$

(Recommended: $4.7\text{ K}\Omega$, $>1/16\text{ W}$)

LCD backlight ON/OFF control signal

2.16 LVDS Connector (LVDS1)

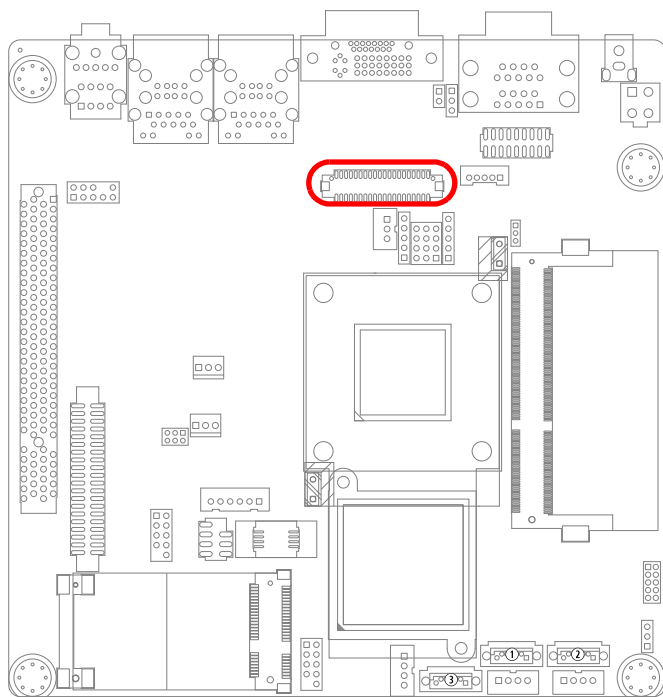

LVDS 1

VDDSAFE_1	□ ○	VDDSAFE_2
GND_1	○ ○	GND_7
VDDSAFE_3	○ ○	VDDSAFE_4
OD0-	○ ○	NC
OD0+	○ ○	NC
GND_2	○ ○	GND_8
OD1-	○ ○	NC
OD1+	○ ○	NC
GND_3	○ ○	GND_9
OD2-	○ ○	NC
OD2+	○ ○	NC
GND_4	○ ○	GND_10
OCK-	○ ○	NC
OCK+	○ ○	NC
GND_5	○ ○	GND_11
DDC_CLK	○ ○	DDC_DAT
GND_6	○ ○	GND_12
OD3-	○ ○	NC
OD3+	○ ○	NC
HPLG	○ ○	VCON

2.17 General purpose I/O Connector (GPIO1)

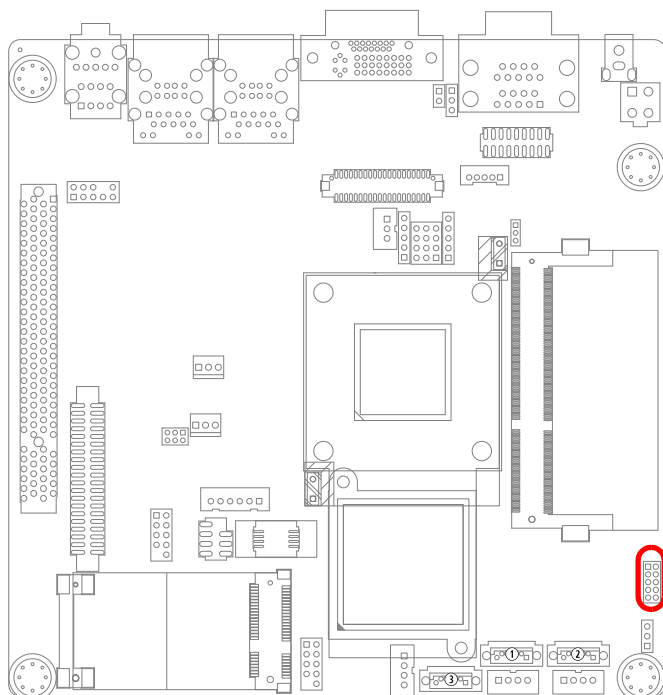

1		
GPI00	□ □	GPI04
GPI01	□ □	GPI05
GPI02	□ □	GPI06
GPI03	□ □	GPI07
+5V	□ □	GND

Chapter 3

BIOS Operation

3.1 Introduction

AMI BIOS has been integrated into many motherboards, and has been very popular for over a decade. People sometimes refer to the AMI BIOS setup menu as BIOS, BIOS setup or CMOS setup.

With the AMI BIOS Setup program, you can modify BIOS settings and control the special features of your computer. The Setup program uses a number of menus for making changes and turning special features on or off. This chapter describes the basic navigation of the AIMB-213 setup screens.

3.2 BIOS Setup

The AIMB-213 Series system has AMI BIOS built in, with a CMOS SETUP utility that allows users to configure required settings or to activate certain system features.

The CMOS SETUP saves the configuration in the CMOS RAM of the motherboard. When the power is turned off, the battery on the board supplies the necessary power to preserve the CMOS RAM.

When the power is turned on, press the button during the BIOS POST (Power-On Self Test) to access the CMOS SETUP screen.

Control Keys

< ↑ >< ↓ >< ← >< → >	Move to select item
----------------------	---------------------

<Enter>	Select Item
---------	-------------

<Esc>	Main Menu - Quit and not save changes into CMOS Sub Menu - Exit current page and return to Main Menu
-------	---

<Page Up/+>	Increase the numeric value or make changes
-------------	--

<Page Down/->	Decrease the numeric value or make changes
---------------	--

<F1>	General help, for Setup Sub Menu
------	----------------------------------

<F2>	Item Help
------	-----------

<F5>	Load Previous Values
------	----------------------

<F7>	Load Setup Defaults
------	---------------------

<F10>	Save all CMOS changes
-------	-----------------------

3.2.1 Main Menu

Press to enter AMI BIOS CMOS Setup Utility, the Main Menu will appear on the screen. Use arrow keys to select among the items and press <Enter> to accept or enter the sub-menu.

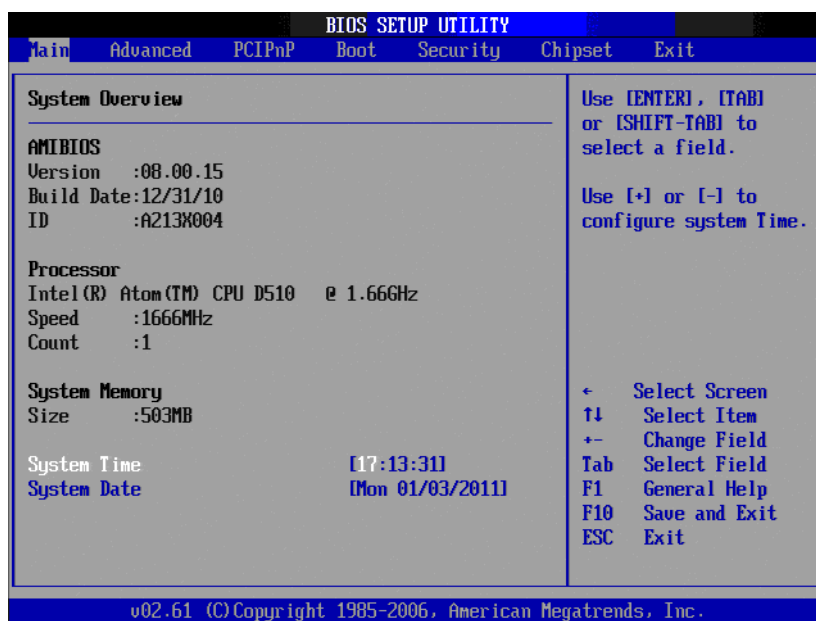

The Main BIOS setup screen has two main frames. The left frame displays all the options that can be configured. Grayed-out options cannot be configured; options in blue can. The right frame displays the key legend.

Above the key legend is an area reserved for a text message. When an option is selected in the left frame, it is highlighted in white. Often a text message will accompany it.

3.2.1.1 System time / System date

Use this option to change the system time and date. Highlight System Time or System Date using the <Arrow> keys. Enter new values through the keyboard. Press the <Tab> key or the <Arrow> keys to move between fields. The date must be entered in MM/DD/YY format. The time must be entered in HH:MM:SS format.

3.2.2 Advanced BIOS Features

Select the Advanced tab from the AIMB-213 setup screen to enter the Advanced BIOS Setup screen. You can select any of the items in the left frame of the screen, such as CPU Configuration, to go to the sub menu for that item. You can display an Advanced BIOS Setup option by highlighting it using the <Arrow> keys. All Advanced BIOS Setup options are described in this section. The Advanced BIOS Setup screen is shown below. The sub menus are described on the following pages.



3.2.2.1 CPU Configuration



- **Max CPUID Value Limit**
This item allows you to limit CPUID maximum value.
- **Execute-Disable Bit Capability**
This item allows you to enable or disable the No-Execution page protection technology.
- **Hyper Threading Technology**
This item allows you to enable or disable Intel Hyper Threading technology.
- **Intel® SpeedStep(tm) tech**
When set to disabled, the CPU runs at its default speed, when set to enabled, the CPU speed is controlled by the operating system.
- **Intel® C-STATE tech**
This item allows the CPU to save more power under idle mode.
- **Enhanced C-States**
CPU idle set to enhanced C-States, disabled by Intel®. C-STATE tech item.

3.2.2.2 IDE Configuration



- **ATA/IDE Configuration**
This can be configured as Disabled, Compatible or Enhanced.
- **Configure SATA as**
This can be configured as IDE or AHCI.
- **Primary, Secondary, and Third Master/Slave**
While entering setup, the BIOS automatically detects the presence of SATA/CF devices. This displays the status of SATA device auto-detection.
- **Hard Disk Write Protect**
Disable/Enable device write protection. This will be effective only if device is accessed through BIOS.
- **IDE Detect Time Out (Sec)**
This item allows you to select the time out value for detecting ATA/ATAPI device(s).
- **AHCI Configuration**
AHCI is a new interface specification that allows the SATA controller driver to support advanced features. While entering setup, BIOS auto detects the presence of AHCI devices. This displays the status of auto detection of AHCI devices.

3.2.2.3 Super I/O Configuration

This item enables users to set the Super I/O device status, including enabling of COMs.

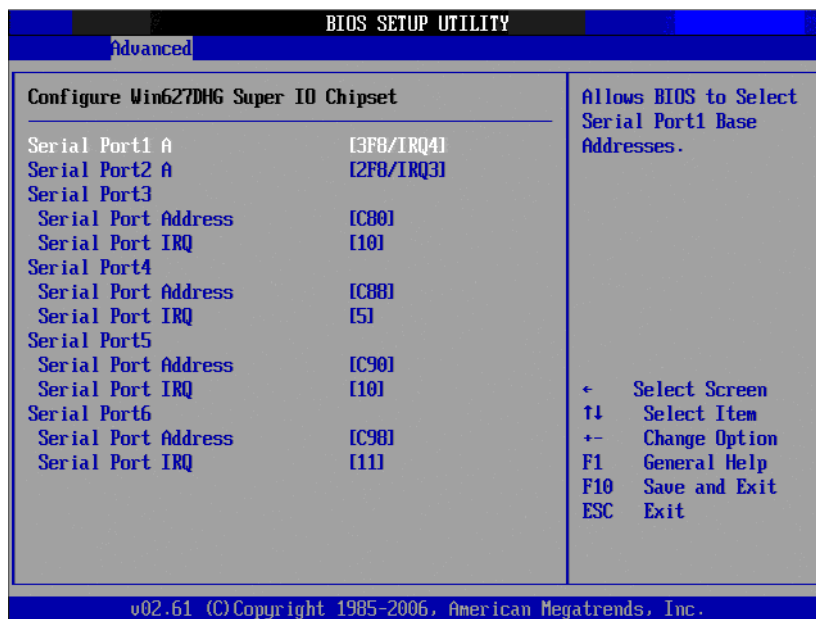

- **Onboard Serial port 1 [3F8 / IRQ4]**
This item allows user to adjust serial port 1 address and IRQ.
- **Onboard Serial port 2 [2F8/ IRQ3]**
This item allows user to adjust serial port 2 address and IRQ.
- **Onboard Serial port 3 [C80/IRQ10]**
This item allows user to adjust serial port 3 address and IRQ.
- **Onboard Serial port 4 [C88/IRQ5]**
This item allows user to adjust serial port 4 address and IRQ.
- **Onboard Serial port 5 [C90/IRQ10]**
This item allows user to adjust serial port 5 address and IRQ.
- **Onboard Serial port 6 [C98/IRQ11]**
This item allows user to adjust serial port 6 address and IRQ.

3.2.2.4 Hardware Health Configuration

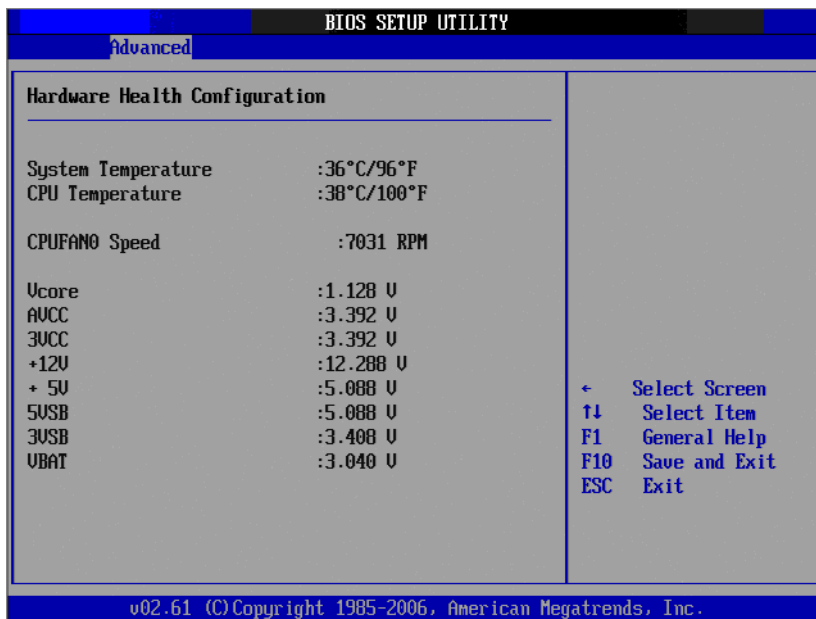

- **System Temperature**
This shows you the current temperature of system.
- **CPU Temperature**
This shows the current CPU temperature.
- **VCORE and Other Voltages**
This shows the voltage of VCORE, +3.3V, +3.3V, +12V, +5V, 5VSB(V), 3.3VSB(V), VBAT(V)

3.2.2.5 ACPI Setting

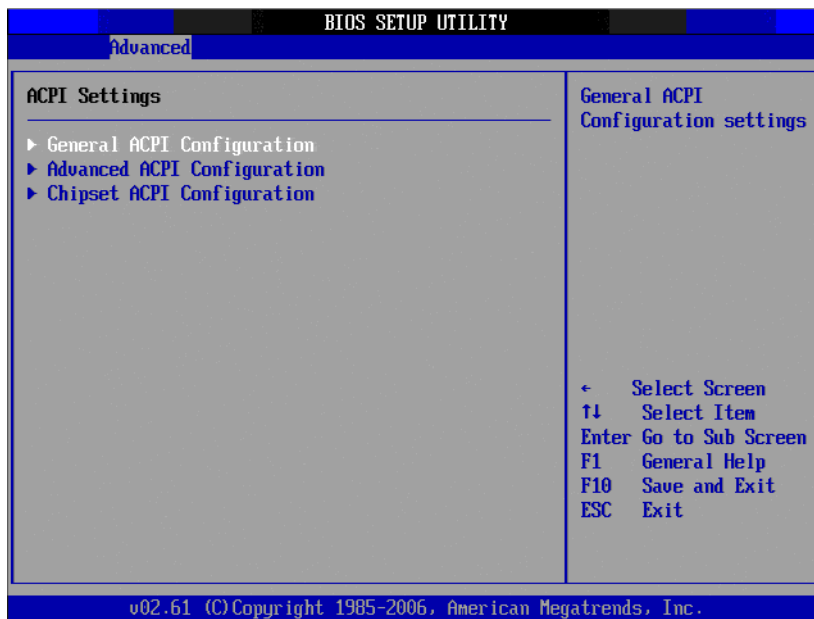

■ General ACPI Configuration

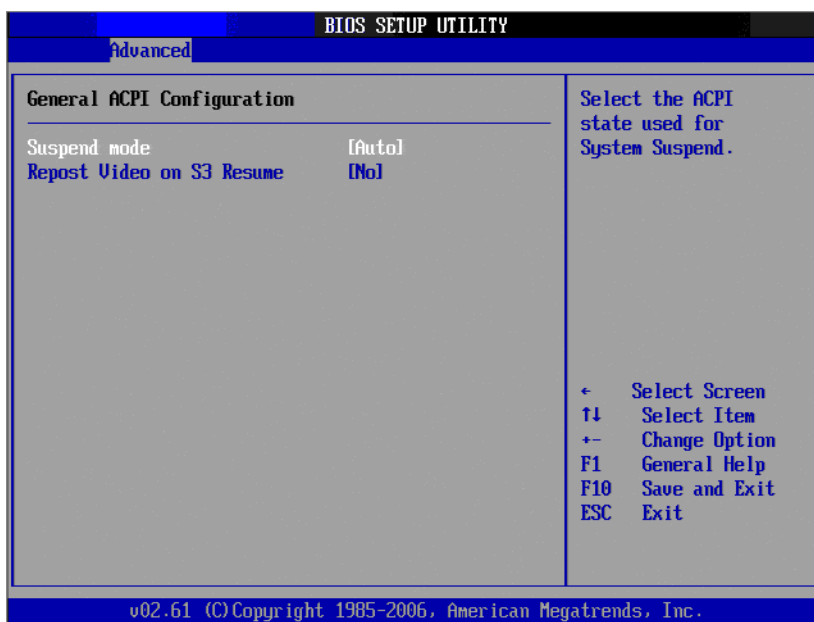

– Suspend mode

Select the ACPI state used for system suspend.

– Report Video on S3 Resume

This item allows you to invoke VA BIOS POST on S3/STR resume.

■ Advanced ACPI Configuration

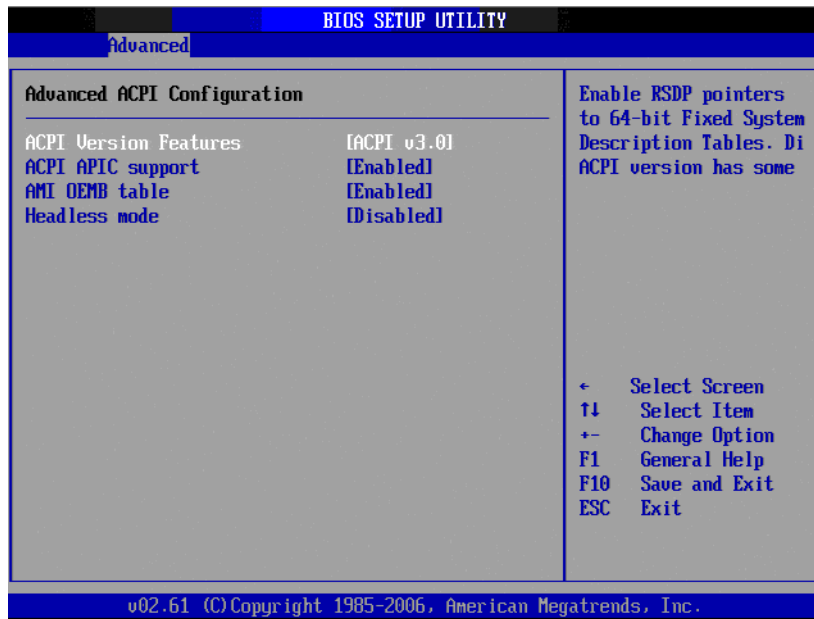

– **ACPI Version Features**

This item allows you to enable RSDP pointers to 64-bit fixed system description tables.

– **ACPI APIC support**

Include APIC table pointer to RSDT pointer list.

– **AMI OEMB table**

Include OEMB table pointer to R(x)SDT pointer lists.

– **Headless mode**

Enable / Disable Headless operation mode through ACPI.

■ Chipset ACPI Configuration

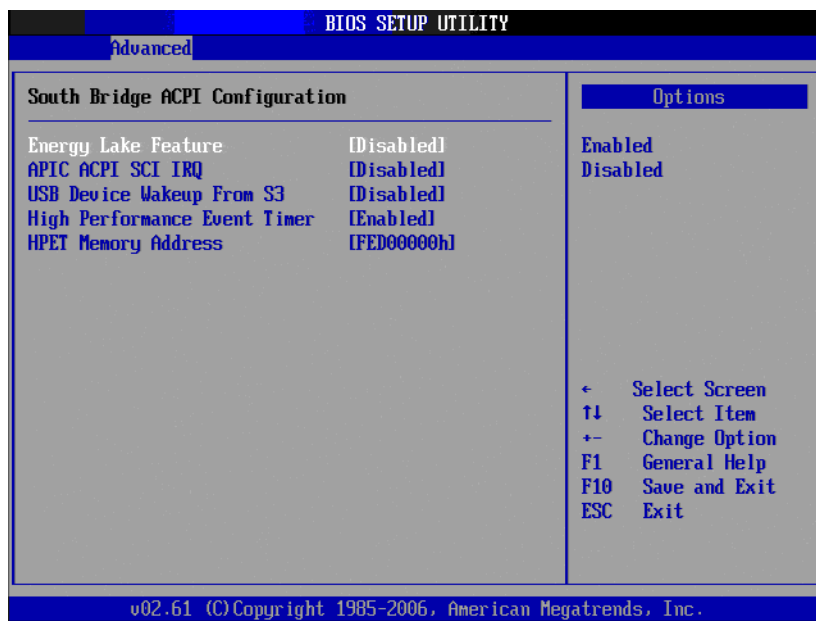

– Energy Lake Feature

Allows you to configure Intel's Energy Lake power management technology.

– APIC ACPI SCI IRQ

Enable/Disable APIC ACPI SCI IRQ.

– USB Device Wakeup From S3

Enable/Disable USB Device Wakeup from S3/S4.

– High Performance Event Timer

Enable/Disable High performance Event timer.

– HPET Memory Address

It will provide you with the means to get to it via the various ACPI methods

3.2.2.6 APM Configuration

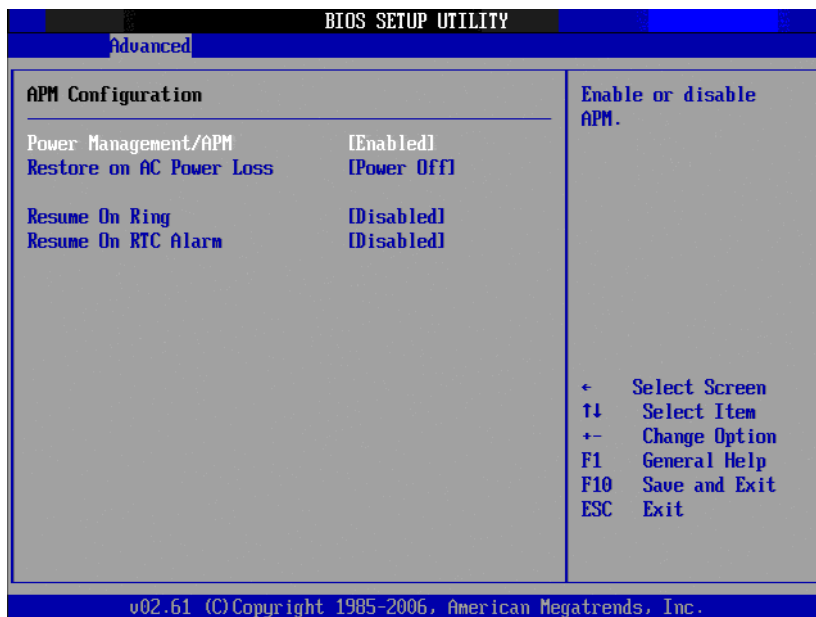

- **Power Management/APM**
Enable or disable APM power management function.
- **Restore on AC Power Loss**
This option allows user to set system action when AC power restores after AC power loss. Available options include Power Off, Power On, Last Status.
- **Resume On Ring**
Disable/Enable RI wake event.
- **Resume On RTC Alarm**
Disable/Enable RTC wake event.

3.2.2.7 USB Configuration

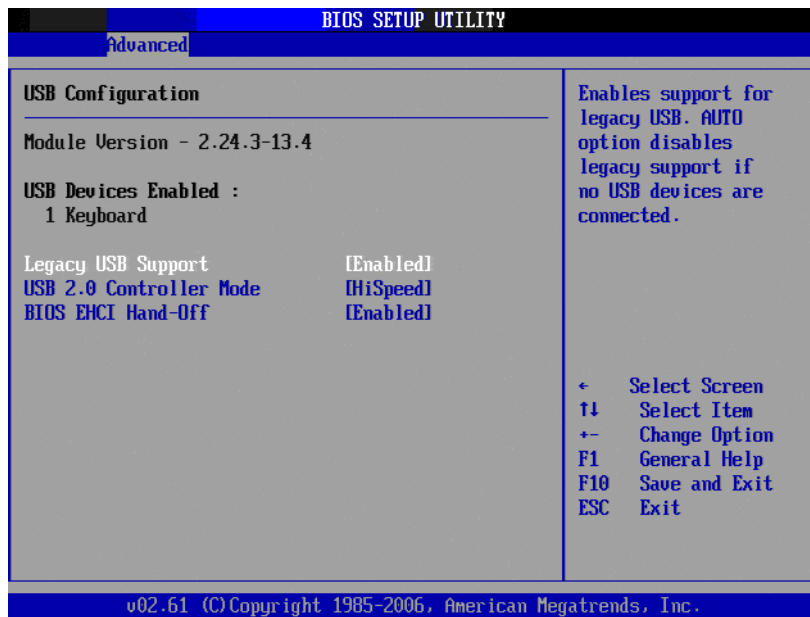

- **Legacy USB Support**
Enables support for legacy USB. Auto option disables legacy support if no USB devices are connected.
- **USB 2.0 Controller Mode**
This item allows you to select HiSpeed (480 Mbps) or FullSpeed (12 Mbps).
- **BIOS EHCI Hand-Off**
This is a workaround for OSs without EHCI hand-off support. The EHCI ownership change should be claimed by EHCI driver.

3.2.3 Advanced PCI/PnP Settings

Select the PCI/PnP tab from the AIMB-213 setup screen to enter the Plug and Play BIOS Setup screen. You can display a Plug and Play BIOS Setup option by highlighting it using the <Arrow> keys. All Plug and Play BIOS Setup options are described in this section. The Plug and Play BIOS Setup screen is shown below.

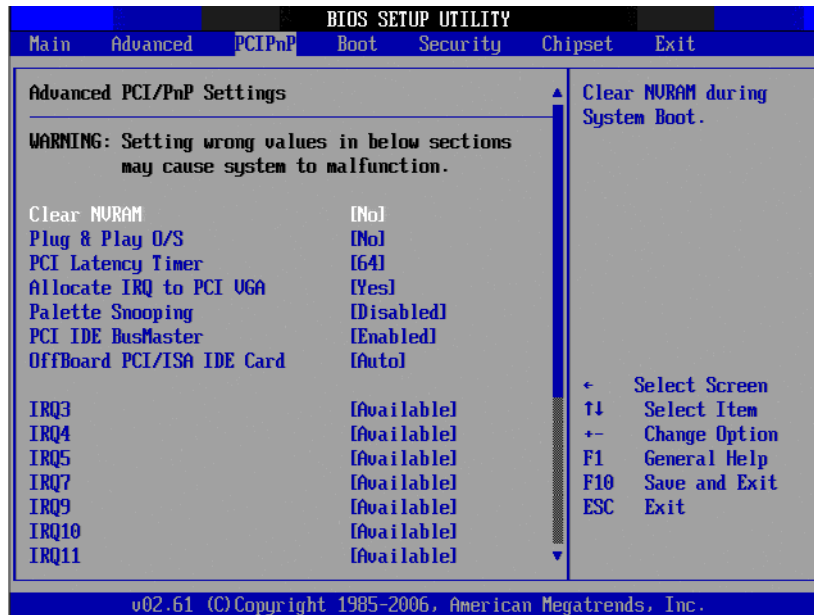

3.2.3.1 Clear NVRAM

Set this value to force the BIOS to clear the Non-Volatile Random Access Memory (NVRAM). The Optimal and Fail-Safe default setting is No.

3.2.3.2 Plug & Play O/S

When set to No, BIOS configures all the devices in the system. When set to Yes and if you install a Plug and Play operating system, the operating system configures the Plug and Play devices not required for bootup.

3.2.3.3 PCI Latency Timer

Value in units of PCI clocks for PCI device latency timer register.

3.2.3.4 Allocate IRQ to PCI VGA

When set to Yes, will assign IRQ to PCI VGA card if card requests IRQ. When set to No will not assign IRQ to PCI VGA card even if card requests an IRQ.

3.2.3.5 Palette Snooping

This item is designed to solve problems caused by some non-standard VGA card.

3.2.3.6 PCI IDE BusMaster

When set to enabled, BIOS uses PCI busmastering for reading/writing to IDE drives.

3.2.3.7 OffBoard PCI/ISA IDE Card

Some PCI IDE cards may require this to be set to the PCI slot number that is holding the card. Set to Auto works for most PCI IDE cards.

3.2.3.8 IRQ3 / 4 / 5 / 7 / 9 / 10 / 11

This item allows you respectively assign an interrupt types for IRQ-3, 4, 5, 7, 9, 10, 11.

3.2.3.9 DMA Channel0 / 1 / 3 / 5 / 6 / 7

When set to Available, will specify DMA is available to be used by PCI/PnP devices. When set to Reserved, will specified DMA is Reserved for use by legacy ISA devices.

3.2.3.10 Reserved Memory Size

This item allows you to reserve a set amount of memory for legacy ISA devices.

3.2.4 Boot Settings



3.2.4.1 Boot settings Configuration

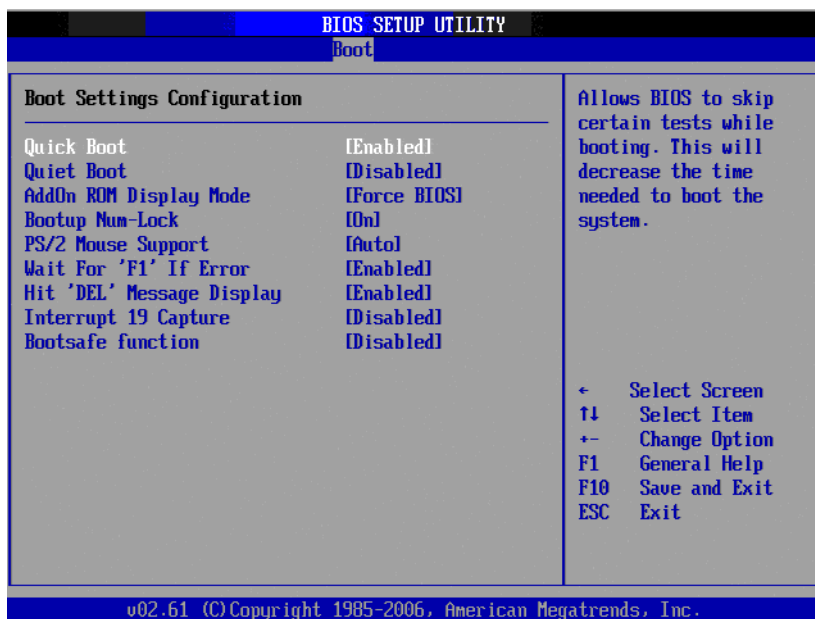

- **Quick Boot**
This item allows BIOS to skip certain tests while booting. This will decrease the time needed to boot the system.
- **Quiet Boot**
If this option is set to Disabled, the BIOS displays normal POST messages. If Enabled, an OEM Logo is shown instead of POST messages.
- **AddOn ROM Display Mode**
Set display mode for option ROM.
- **Bootup Num-Lock**
Select the Power-on state for Numlock.

- **PS/2 Mouse Support**
Select support for PS/2 Mouse.
- **Wait For .F1. If Error**
Wait for the F1 key to be pressed if an error occurs.
- **Hit .DEL. Message Display**
Displays .Press DEL to run Setup. in POST.
- **Interrupt 19 Capture**
This item allows option ROMs to trap interrupt 19.
- **Bootsafe Function**
This item allows you to enable or disable bootsafe function.

3.2.5 Security Setup

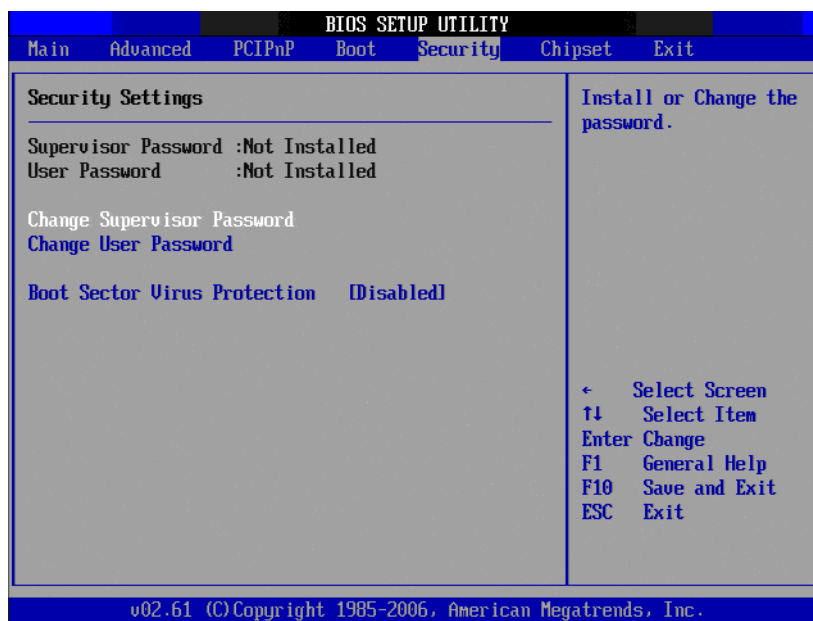

Select Security Setup from the AIMB-213 Setup main BIOS setup menu. All Security Setup options, such as password protection and virus protection are described in this section. To access the sub menu for the following items, select the item and press <Enter>:

3.2.5.1 Change Supervisor / User Password

Provides for either installing or changing the password.

3.2.5.2 Boot Sector Virus Protection

The boot sector virus protection will warn if any program tries to write to the boot sector.

3.2.6 Advanced Chipset Settings



3.2.6.1 North Bridge Chipset Configuration

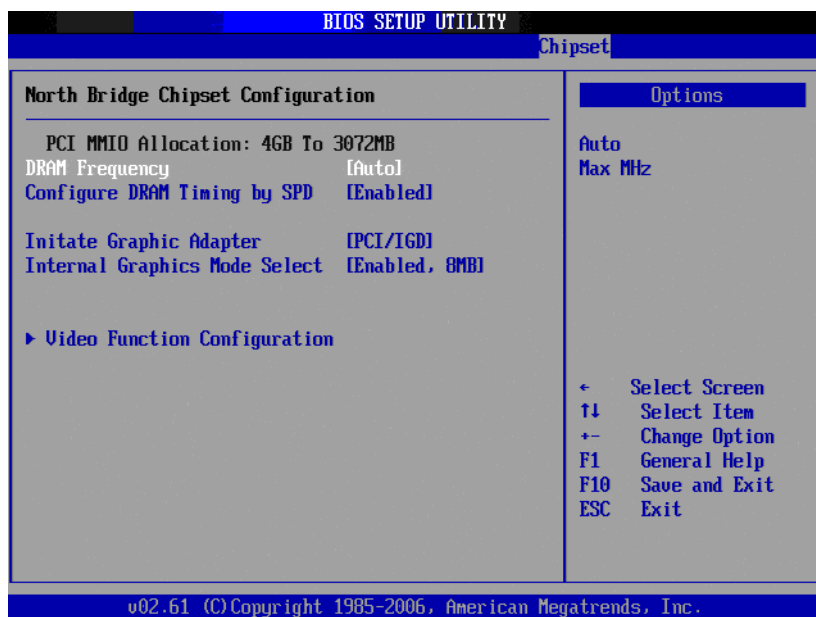

- **DRAM Frequency**
This item allows you to manually change DRAM frequency.
- **Configure DRAM Timing by SPD**
This item allows you to enable or disable detect by DRAM SPD.
- **Initiate Graphic Adapter**
This item allows you to select which graphics controller to use as the primary boot device.
- **Internal Graphics Mode Select**
Select the amount of system memory used by the Internal graphics device.

■ Video Function Configuration



– DVMT Mode Select

Displays the active system memory mode.

– DVMT/FIXED Memory

Specifies the amount of DVMT / FIXED system memory to allocate for video memory.

– Boot Display Device

Select boot display device at post stage.

– Flat Panel Type

This item allows you to select panel resolution.

– DVI Panel Type

This item allows you to select DVI panel resolution.

– Spread Spectrum Clock

This item allows you to enable or disable spread spectrum clock.

3.2.6.2 South Bridge Chipset Configuration



– USB Functions

Select: Disabled, 2 USB Ports, 4 USB Ports, 6 USB Ports or 8 USB Ports.

– USB 2.0 Controller

Enables or disables the USB 2.0 controller.

– LAN1 Controller

Enables or disables the GbE controller.

– LAN1 Option-ROM

Enables or disables GbE LAN boot.

– Resume on LAN1

Enables or disables GbE LAN wake up from S5 function.

– LAN2 Controller

Enables or disables the GbE controller.

– LAN2 Option-ROM

Enables or disables GbE LAN boot.

– Resume on LAN2

Enables or disables GbE LAN wake up from S5 function.

– HDA Controller

Enables or disables the HDA controller.

– SMBUS Controller

Enables or disables the SMBUS controller.

– SLP_S4# Min. Assertion Width

This item allows you to set a delay of a set number of seconds.

3.2.7 Exit Option

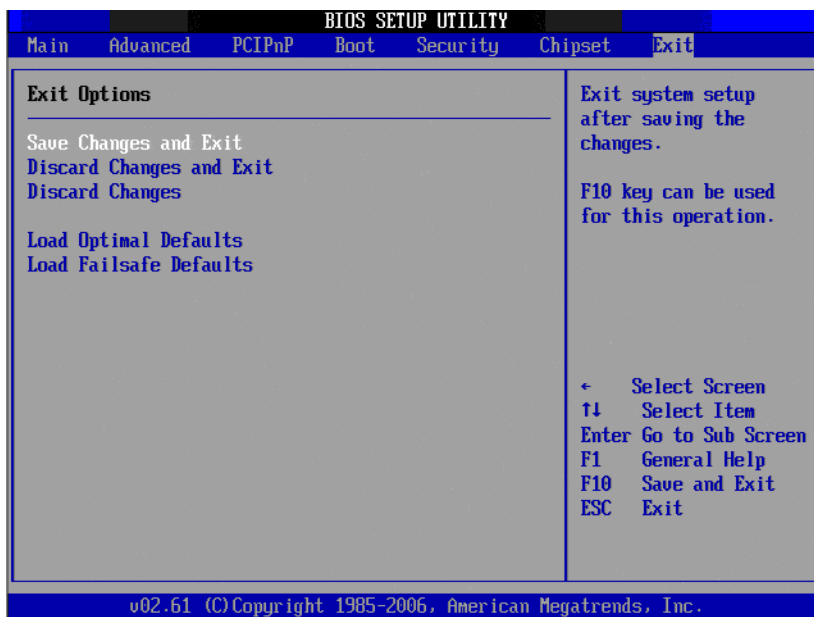

3.2.7.1 Save Changes and Exit

When you have completed system configuration, select this option to save your changes, exit BIOS setup and reboot the computer so the new system configuration parameters can take effect.

1. Select Save Changes and Exit from the Exit menu and press <Enter>. The following message appears:
Save Configuration Changes and Exit Now?
[Ok] [Cancel]
2. Select Ok or Cancel.

3.2.7.2 Discard Changes and Exit

Select this option to quit Setup without making any permanent changes to the system configuration.

1. Select Discard Changes and Exit from the Exit menu and press <Enter>. The following message appears:
Discard Changes and Exit Setup Now?
[Ok] [Cancel]
2. Select Ok to discard changes and exit.

3.2.7.3 Discard Changes

1. Select Discard Changes from the Exit menu and press <Enter>.

3.2.7.4 Load Optimal Defaults

The AIMB-213 automatically configures all setup items to optimal settings when you select this option. Optimal Defaults are designed for maximum system performance, but may not work best for all computer applications. In particular, do not use the Optimal.

Defaults if your computer is experiencing system configuration problems. Select Load Optimal Defaults from the Exit menu and press <Enter>.

3.2.7.5 Load Failsafe Defaults

The AIMB-213 automatically configures all setup options to failsafe settings when you select this option. Failsafe Defaults are designed for maximum system stability, but not maximum performance. Select Failsafe Defaults if your computer is experiencing system configuration problems.

1. Select Load Failsafe Defaults from the Exit menu and press <Enter>. The following message appears:
Load Failsafe Defaults?
[OK] [Cancel]
2. Select OK to load Failsafe defaults.

Chapter 4

Software Introduction
& Service

4.1 Introduction

The mission of Advantech Embedded Software Services is to "Enhance quality of life with Advantech platforms and Microsoft® Windows® embedded technology." We enable Windows® Embedded software products on Advantech platforms to more effectively support the embedded computing community. Customers are freed from the hassle of dealing with multiple vendors (hardware suppliers, system integrators, embedded OS distributors) for projects. Our goal is to make Windows® Embedded Software solutions easily and widely available to the embedded computing community.

4.2 Value-Added Software Services

Software API: An interface that defines the ways by which an application program may request services from libraries and/or operating systems. Provides not only the underlying drivers required but also a rich set of user-friendly, intelligent and integrated interfaces, which speeds development, enhances security and offers add-on value for Advantech platforms. It plays the role of catalyst between developer and solution, and makes Advantech embedded platforms easier and simpler to adopt and operate with customer applications.

4.2.1 Software API

4.2.1.1 Control

GPIO



General Purpose Input/Output is a flexible parallel interface that allows a variety of custom connections. It allows users to monitor the signal input level or set the output status to switch on/off the device. Our API also provides Programmable GPIO, which allows developers to dynamically set the GPIO input or output status.

SMBus



SMBus is the System Management Bus as defined by Intel® Corporation in 1995. It is used in personal computers and servers for low-speed system management communications. The SMBus API allows a developer to interface an embedded system environment and transfer serial messages using the SMBus protocols, allowing multiple simultaneous device control.

4.2.1.2 Display

Brightness Control



The Brightness Control API allows a developer to access embedded devices and easily control brightness.

Backlight



The Backlight API gives the developer on/off control of the backlight (screen) in embedded devices.

4.2.1.3 Monitor

Watchdog



A watchdog timer (WDT) is a device that performs a specific operation after a set period of time if something goes wrong and the system does not recover on its own. A watchdog timer can be programmed to perform a warm boot (restarting the system) after a certain number of seconds.

Hardware Monitor



The Hardware Monitor (HWM) API is a system health supervision API that inspects condition indexes such as fan speed, temperature, and voltage.

4.2.1.4 Power Saving

CPU Speed



Makes use of Intel® SpeedStep technology to save power consumption. The system can automatically adjust the CPU speed depending on loading.

System Throttling

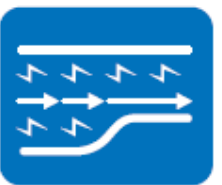

Refers to a series of methods for reducing power consumption in computers by lowering the clock frequency. This API allows the user to change clock frequency setting from 87.5% to 12.5%.

4.2.2 Software Utility

BIOS Flash

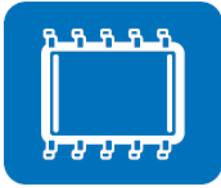

The BIOS Flash utility allows the customer to update the flash ROM BIOS version, or to back up current BIOS by copying it from the flash chip to a file on the customer's disk. The BIOS Flash utility also provides a command line version and an API for fast implementation into customized applications.

Embedded Security ID



Embedded applications represent valuable intellectual property, design knowledge, and innovation that belong to the System Integrator. But they are easily copied! Embedded Security ID utility provides reliable functions that allow customers to secure their application data within embedded BIOS.

Monitoring



Monitoring is a utility that allows the customer to monitor system health parameters like voltage, CPU, system temperature and fan speed. These items are important to a device; if critical errors occur and are not solved immediately, permanent damage may occur.

Flash Lock



Flash Lock is a mechanism for binding the Board and CF card (SQFlash) together. The user can "Lock" SQFlash via Flash Lock function and "Unlock" in BIOS while booting. A locked SQFlash cannot be read by any card reader or boot from other platforms without a BIOS with "Unlock" feature.

eSOS



The eSOS is a small OS stored in BIOS ROM. It boots up in the event of a main OS crash. It diagnoses hardware status, and sends an e-mail to the designated administrator. The eSOS also provides for remote connection via Telnet server and FTP server so the administrator can attempt to rescue the system. Note: This function requires BIOS customization.

Chapter 5

Chipset Software
Installation Utility

5.1 Before You Begin

To facilitate the installation of the enhanced display drivers and utility software, read the instructions in this chapter carefully. The drivers for the AIMB-213 are located on the software installation CD. The driver in the folder of the driver CD will guide and link you to the utilities and drivers under a Windows system. Updates are provided via Service Packs from Microsoft*.

Note! *The files on the software installation CD are compressed. Do not attempt to install the drivers by copying the files manually. You must use the supplied SETUP program to install the drivers.*



Before you begin, it is important to note that most display drivers need to have the relevant software application already installed in the system prior to installing the enhanced display drivers. In addition, many of the installation procedures assume that you are familiar with both the relevant software applications and operating system commands. Review the relevant operating system commands and the pertinent sections of your application software's user manual before performing the installation.

5.2 Introduction

The Intel® Chipset Software Installation (CSI) utility installs the Windows INF files that outline to the operating system how the chipset components will be configured. This is needed for the proper functioning of the following features:

- Core PCI PnP services
- IDE Ultra ATA 100/66/33 and Serial ATA interface support
- USB 1.1/2.0 support (USB 2.0 driver needs to be installed separately for Win98)
- Identification of Intel® chipset components in the Device Manager
- Integrates superior video features. These include filtered sealing of 720 pixel DVD content, and MPEG-2 motion compensation for software DVD

Note! *This utility is used for the following versions of Windows, and it has to be installed **before** installing all the other drivers:*



- Windows 7
- Windows Vista
- Windows XP

5.3 Windows XP Driver Setup

1. Insert the driver CD into your system's CD-ROM drive. You can see the driver folder items. Navigate to the "Chipset" folder and click "infinst_autol.exe" to complete the installation of the driver.

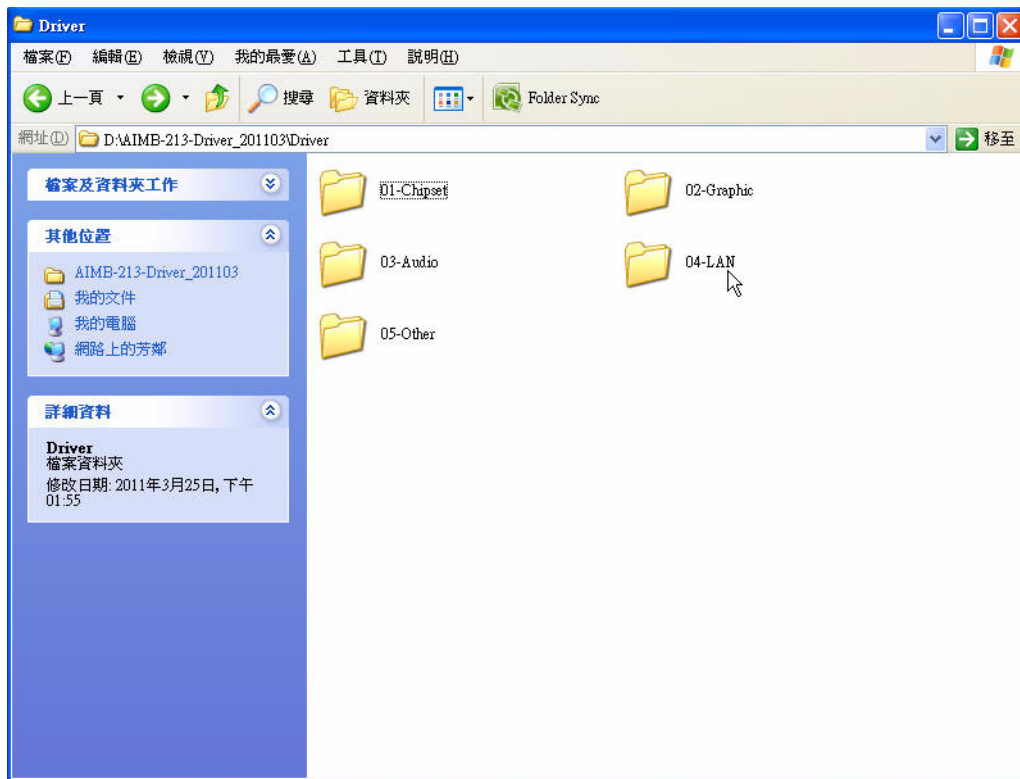

Chapter 6

VGA Setup

6.1 Introduction

To benefit from the Intel® Atom N455/D525 integrated graphics controller, you need to install the graphic driver.

6.2 Windows 7/Vista/XP

Note! Before installing this driver, make sure the CSI utility has been installed in your system. See Chapter 5 for information on installing the CSI utility.



Insert the driver CD into your system's CD-ROM drive. You can see the driver folders items. Navigate to the "Graphic" folder and click "setup.exe" to complete the installation of the drivers for Windows 7, Windows Vista, Windows XP.

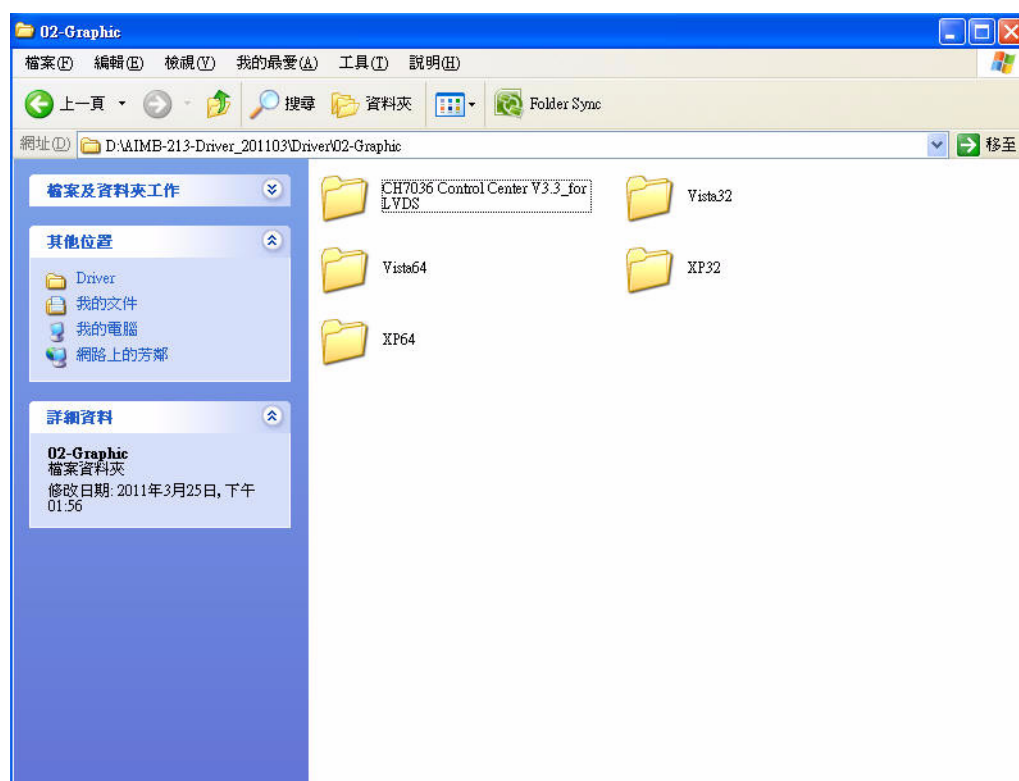

Chapter 7

LAN Configuration

7.1 Introduction

The AIMB-213 has dual Gigabit Ethernet LANs via dedicated PCI Express x1 lanes (Intel 82567V (LAN1) and 82583V (LAN2)) that offer bandwidth of up to 500 MB/sec, eliminating the bottleneck of network data flow and incorporating Gigabit Ethernet at 1000 Mbps.

7.2 Features

- Integrated 10/100/1000 Mbps transceiver
- 10/100/1000 Mbps triple-speed MAC
- High-speed RISC core with 24-KB cache
- On-chip voltage regulation
- Wake-on-LAN (WOL) support
- PCI Express X1 host interface

7.3 Installation

Note! *Before installing the LAN drivers, make sure the CSI utility has been installed on your system. See Chapter 5 for information on installing the CSI utility.*



The AIMB-213's Intel 82567V (LAN1) and 82583V (LAN2) Gigabit integrated controllers support all major network operating systems. However, the installation procedure varies from system to system. Please find and use the section that provides the driver setup procedure for the operating system you are using.

7.4 Windows 7/Vista/XP Driver Setup (Intel 82567v/82583v)

Insert the driver CD into your system's CD-ROM drive. Select the LAN folder then navigate to the directory for your OS.

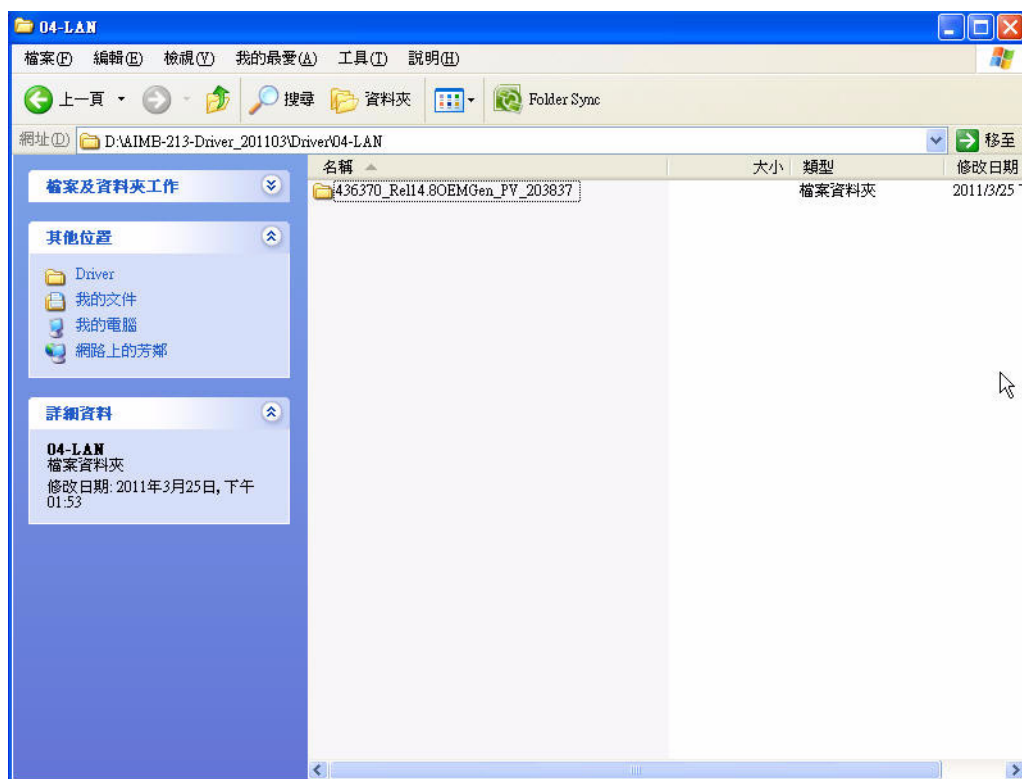

Appendix **A**

Programming the
Watchdog Timer

A.1 Programming the Watchdog Timer

The AIMB-213's watchdog timer can be used to monitor system software operation and take corrective action if the software fails to function within the programmed period. This section describes the operation of the watchdog timer and how to program it.

A.1.1 Watchdog Timer Overview

The watchdog timer is built into the super I/O controller W83627DHG-P. It provides the following user-programmable functions:

- Can be enabled and disabled by user program
- Timer can be set from 1 to 255 seconds or 1 to 255 minutes
- Generates an interrupt or resets signal if the software fails to reset the timer before time-out

A.1.2 Programming the Watchdog Timer

The I/O port address of the watchdog timer is 2E (hex) and 2F (hex). 2E (hex) is the address port. 2F (hex) is the data port. You must first assign the address of register by writing an address value into address port 2E (hex), then write/read data to/from the assigned register through data port 2F (hex).

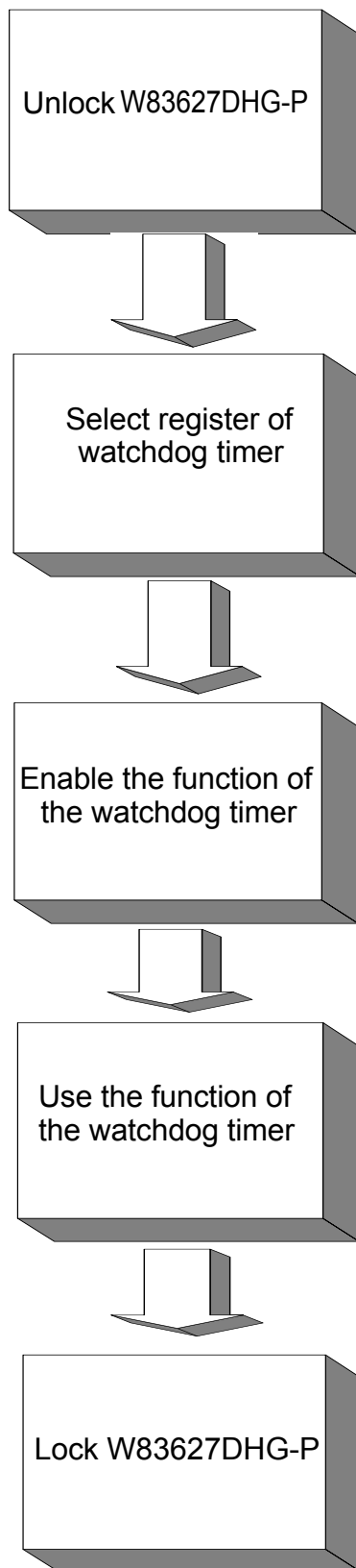

Table A.1: Watchdog Timer Registers

Address of Register (2E)	Attribute	Value (2F) & description
87 (hex)	-----	Write this address to I/O address port 2E (hex) twice to unlock the W83627DHG-P.
07 (hex)	write	Write 08 (hex) to select register of watchdog timer.
30 (hex)	write	Write 01 (hex) to enable the function of the watchdog timer. Disabled is set as default.
F5 (hex)	write	Set seconds or minutes as units for the timer. Write 0 to bit 3: set second as counting unit. [default] Write 1 to bit 3: set minutes as counting unit.
F6 (hex)	write	0: stop timer [default] 01~FF (hex): The amount of the count, in seconds or minutes, depends on the value set in register F5 (hex). This number decides how long the watchdog timer waits for strobe before generating an interrupt or reset signal. Writing a new value to this register can reset the timer to count with the new value.
F7 (hex)	read/write	Bit 7: Write 1 to enable mouse to reset the timer, 0 to disable [default]. Bit 6: Write 1 to enable keyboard to reset the timer, 0 to disable. [default] Bit 5: Write 1 to generate a timeout signal immediately and automatically return to 0. [default=0] Bit 4: Read status of watchdog timer, 1 means timer is "timeout".
AA (hex)	-----	Write this address to I/O port 2E (hex) to lock the watchdog timer 2.

A.1.3 Example Program

1. Enable watchdog timer and set 10 sec. as timeout interval

```

;-----
Mov dx,2eh ; Unlock W83627DHG-P
Mov al,87h
Out dx,al
Out dx,al
;-----
Mov al,07h ; Select registers of watchdog timer
Out dx,al
Inc dx
Mov al,08h
Out dx,al
;-----
Dec dx ; Enable the function of watchdog timer
Mov al,30h
Out dx,al
Inc dx
Mov al,01h
Out dx,al
;-----
Dec dx ; Set second as counting unit
Mov al,0f5h
Out dx,al
Inc dx
In al,dx
And al,not 08h
Out dx,al
;-----
Dec dx ; Set timeout interval as 10 seconds and start counting
Mov al,0f6h
Out dx,al
Inc dx
Mov al,10
Out dx,al
;-----
Dec dx ; Lock W83627DHG-P
Mov al,0aah
Out dx,al

```

2. Enable watchdog timer and set 5 minutes as timeout interval

```

;-----
Mov dx,2eh ; Unlock W83627DHG-P
Mov al,87h
Out dx,al
Out dx,al

```

```

;-----
Mov al,07h ; Select registers of watchdog timer
Out dx,al
Inc dx
Mov al,08h
Out dx,al
;-----
Dec dx ; Enable the function of watchdog timer
Mov al,30h
Out dx,al
Inc dx
Mov al,01h
Out dx,al
;-----
Dec dx ; Set minute as counting unit
Mov al,0f5h
Out dx,al
Inc dx
In al,dx
Or al,08h
Out dx,al
;-----
Dec dx ; Set timeout interval as 5 minutes and start counting
Mov al,0f6h
Out dx,al
Inc dx
Mov al,5
Out dx,al
;-----
Dec dx ; Lock W83627DHG-P
Mov al,0aah
Out dx,al
3. Enable watchdog timer to be reset by mouse
;-----
Mov dx,2eh ; Unlock W83627DHG-P
Mov al,87h
Out dx,al
Out dx,al
;-----
Mov al,07h ; Select registers of watchdog timer
Out dx,al
Inc dx
Mov al,08h
Out dx,al
;-----

```



```

Dec dx ; Enable the function of watchdog timer
Mov al,30h
Out dx,al
Inc dx
Mov al,01h
Out dx,al
;-----
Dec dx ; Enable watchdog timer to be reset by mouse
Mov al,0f7h
Out dx,al
Inc dx
In al,dx
Or al,80h
Out dx,al
;-----
Dec dx ; Lock W83627DHG-P
Mov al,0aah
Out dx,al
4. Enable watchdog timer to be reset by keyboard
;-----
Mov dx,2eh ; Unlock W83627DHG-P
Mov al,87h
Out dx,al
Out dx,al
;-----
Mov al,07h ; Select registers of watchdog timer
Out dx,al
Inc dx
Mov al,08h
Out dx,al
;-----
Dec dx ; Enable the function of watchdog timer
Mov al,30h
Out dx,al
Inc dx
Mov al,01h
Out dx,al
;-----
Dec dx ; Enable watchdog timer to be strobed reset by keyboard
Mov al,0f7h
Out dx,al
Inc dx
In al,dx
Or al,40h
Out dx,al

```

```

;-----
Dec dx ; Lock W83627DHG-P
Mov al,0aah
Out dx,al
5. Generate a time-out signal without timer counting
;-----
Mov dx,2eh ; Unlock W83627DHG-P
Mov al,87h
Out dx,al
Out dx,al
;-----
Mov al,07h ; Select registers of watchdog timer
Out dx,al
Inc dx
Mov al,08h
Out dx,al
;-----
Dec dx ; Enable the function of watchdog timer
Mov al,30h
Out dx,al
Inc dx
Mov al,01h
Out dx,al
;-----
Dec dx ; Generate a time-out signal
Mov al,0f7h
Out dx,al ;Write 1 to bit 5 of F7 register
Inc dx
In al,dx
Or al,20h
Out dx,al
;-----
Dec dx ; Lock W83627DHG-P
Mov al,0aah
Out dx,al

```

Appendix **B**

I/O Pin Assignments

B.1 USB Header (USB56, USB78)

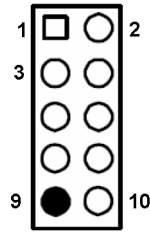

Table B.1: USB Header (USB56)

Pin	Signal	Pin	Signal
1	USB0_VCC5	2	USB1_VCC5
3	USB0_D-	4	USB1_D-
5	USB0_D+	6	USB1_D+
7	GND	8	GND
9	Key	10	GND

B.2 VGA Connector (VGA1)

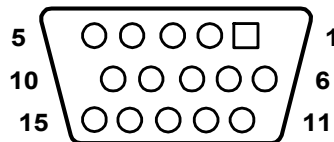

Table B.2: VGA Connector (VGA1)

Pin	Signal	Pin	Signal
1	RED	9	CRT_VCCIN
2	VGA_G	10	GND
3	VGA_B	11	N/C
4	N/C	12	V_SDAT
5	GND	13	H-SYNC
6	GND	14	V-SYNC
7	GND	15	V_SCLK

B.3 RS-232 Interface (COM3/4/5/6)

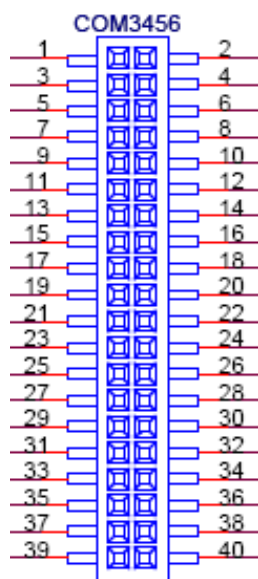

Table B.3: RS-232 Interface (COM3~COM6)

Pin	Signal	Pin	Signal
1	DCD_3	2	DSR_3
3	RXD_3	4	RTS_3
5	TXD_3	6	CTS_3
7	DTR_3	8	RRI_3
9	GND_3	10	GND_3
11	DCD_4	12	DSR_4
13	RXD_4	14	RTS_4
15	TXD_4	16	CTS_4
17	DTR_4	18	RRI_4
19	GND_4	20	GND_4
21	DCD_5	22	DSR_5
23	RXD_5	24	RTS_5
25	TXD_5	26	CTS_5
27	DTR_5	28	RRI_5
29	GND_5	30	GND_5
31	DCD_6	32	DSR_6
33	RXD_6	34	RTS_6
35	TXD_6	36	CTS_6
37	DTR_6	38	RRI_6
39	GND_6	40	GND_6

B.4 RS-232/422/485 Setting Interface (JSETCOM2)

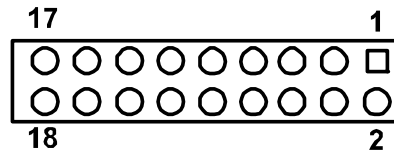

Table B.4: RS-232/422/485 Setting Interface (JSETCOM2)

Pin	Signal	Pin	Signal
1	R_SINA	2	RXD485_1
3	R_SINA	4	RXD422_1
5	R_SINA	6	RXD232_1
7	DCDA	8	SOUTA
9	COM1_DCD#	10	COM1_SOUT
11	COM1_TXD485N	12	COM1_RXD485P
13	SINA	14	DTRA
15	COM1_SIN	16	COM1_DTR#
17	COM1_TXD485P	18	COM1_RXD485N

B.5 SPI_CN1: SPI Fresh Card Pin Connector

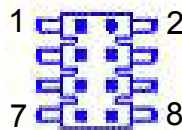

Table B.5: SPI_CN1:SPI Fresh Card Pin Connector

Pin	Signal	Pin	Signal
1	+F1_3V	2	GND
3	F1_SPI_CS#_Q	4	F1_SPI_CLK_Q
5	F1_SPI_MISO_Q	6	F1_SPI_MOSI_Q
7	NC	8	NC

B.6 PS/2 Keyboard and Mouse Connector (KBMS1)

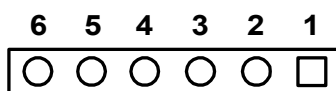

Table B.6: PS/2 Keyboard and Mouse Connector (KBMS1)

Pin	Signal
1	KCLK_B
2	KDAT_B
3	MDAT_B
4	GND
5	KBMS1_VCC
6	MCLK_B

B.7 CPU Fan Power Connector (CPU_FAN1)

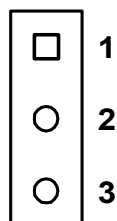

Table B.7: CPU Fan Power Connector (CPU_FAN1)

Pin	Signal
1	GND
2	+12 V
3	DETECT

B.8 System Fan Power Connector (CHA_FAN1)

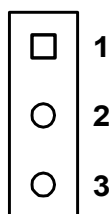

Table B.8: System Fan Power Connector (SYSFAN1/SYSFAN2)

Pin	Signal
1	GND
2	+12 V
3	DETECT

B.9 Power LED & Keyboard Lock Connector (JFP1)

You can use an LED to indicate when the single board computer is on. Pin 1 of JFP3 supplies the LED's power, and Pin 3 is the ground.

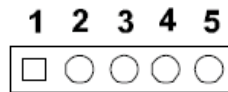

Table B.9: Power LED & Keyboard Lock Connector (JFP1)

Pin	Function
1	LED power
2	NC
3	GND
4	KEYLOCK#
5	GND

B.10 Power switch/HDD LED/SMBus/Speaker (JFP1+JFP2)

The single board computer has its own buzzer. You can also connect it to the external speaker on your computer chassis.

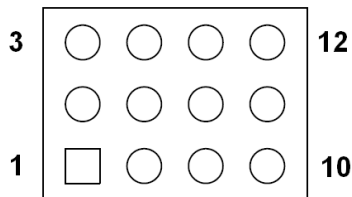

Table B.10: Power Switch/HDD LED/SMBus/Speaker (JFP1+JFP2)

Pin	Signal	Pin	Signal
1	SPK_P1	2	HDDLED+
3	PWR	4	NC
5	HDDLED-	6	GND
7	SPK_P3	8	SMB_DAT
9	SYS_RST	10	SPK_P4
11	SMB_CLK	12	GND

B.11 USB/LAN ports (LAN1_USB12/LAN2_USB34)

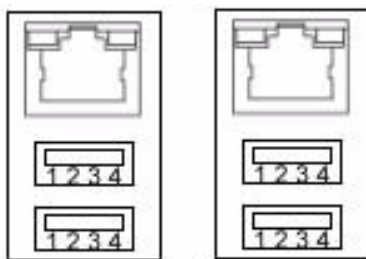

Table B.11: USB Port

Pin	Signal	Pin	Signal
1	VCC	3	Data0+
2	Data0-	4	GND

Table B.12: Ethernet 10/100 Mbps RJ-45 Port

Pin	Signal	Pin	Signal
1	XMT+	5	N/C
2	XMT-	6	RCV-
3	RCV+	7	N/C
4	N/C	8	N/C

B.12 Line In, Line Out, Mic In Connector (AUDIO1)

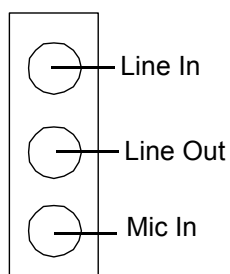

B.13 Serial ATA0/1 (SATA1/2/3)

Table B.13: Serial ATA 0/1 (SATA1/2/3)

Pin	Signal	Pin	Signal
1	GND	2	SATA_0TX+
3	SATA_0TX-	4	GND
5	SATA_0RX-	6	SATA_0RX+
7	GND	8	

B.14 AT/ATX Mode (PSON1)

Table B.14: AT/ATX Mode (PSON1)

Pin	Signal	Pin	Signal
1	VCCATX	2	VCCATX
3	GND		

B.15 HD Audio Interface (HD1)

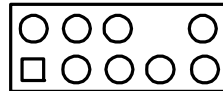

Table B.15: AC-97 Audio Interface (HD1)

Pin	Signal	Pin	Signal
1	MIC2_L	2	GND
3	MIC2_R	4	FP_AUD_DET
5	LOUT2_R	6	SRTN1
7	LOUT2_DET	8	KEY
9	LOUT2_L	10	SRTN2

B.16 GPIO Pin Header (GPIO1)

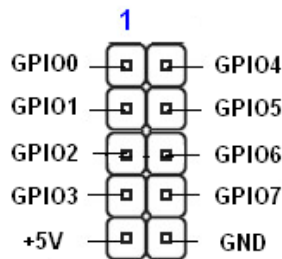

Table B.16: GPIO Pin Header (GPIO1)

Pin	Signal	Pin	Signal
1	GPIO0	2	GPIO4
3	GPIO1	4	GPIO5
5	GPIO2	6	GPIO6
7	GPIO3	8	GPIO7
9	+5V	10	GND

B.17 LVDS Connector: LVDS1

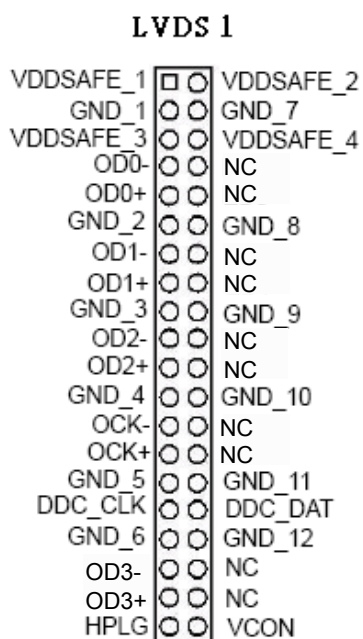
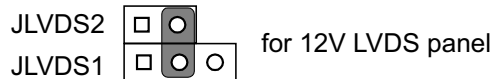
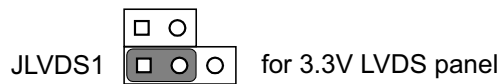

Table B.17: LVDS1 Connector

Pin	Signal	Pin	Signal
1	VDDSAFE_1	2	VDDSAFE_2
3	GND_1	4	GND_7
5	VDDSAFE_3	6	VDDSAFE_4
7	OD0-	8	NC
9	OD0+	10	NC
11	GND_2	12	GND_8
13	OD1-	14	NC
15	OD1+	16	NC
17	GND_3	18	GND_9
19	OD2-	20	NC
21	OD2+	22	NC
23	GND_4	24	GND_10
25	OCK-	26	NC
27	OCK+	28	NC
29	GND_3	30	GND_11
31	DDC_CLK	32	DDC_DAT
33	GND_6	34	GND_12
35	OD3-	36	NC
37	OD3+	38	NC
39	HPLG	40	VCON

B.18 LVDS Power Jumper (JLVDS1 and JLVDS2)



* default setting

Table B.18: LVDS Power Jumper

Pin	Signal
1	VCC3
2	VCC_LCD
3	VCC

B.19 LVDS Inverter (INV1)

Table B.19: LVDS Power Jumper

Pin	Signal
1	+12V
2	GND
3	BL_EN
4	BL_CLT
5	+5V

B.20 ATX 12 V connector (ATX12V_1)

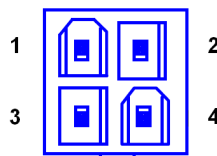

Table B.20: ATX 12 V connector (ATX12V_1)

Pin	Signal	Pin	Signal
1	GND	2	GND
3	+12V	4	+12V

B.21 DMA Channel Assignments

Table B.21: DMA Channel Assignments

Channel	Function
0	Available
1	Available
2	Floppy disk (8-bit transfer)
3	Available
4	Cascade for DMA controller 1
5	Available
6	Available
7	Available

B.22 Interrupt Assignments

Table B.22: Interrupt Assignments

Priority	Interrupt#	Interrupt source
1	NMI	Parity error detected
2	IRQ0	Interval timer
3	IRQ1	Keyboard
-	IRQ2	Interrupt from controller 2 (cascade)
4	IRQ8	Real-time clock
5	IRQ9	Cascaded to INT 0A (IRQ 2)
6	IRQ10	Serial communication port 3/5
7	IRQ11	Serial communication port 6
8	IRQ12	PS/2 mouse
9	IRQ13	INT from co-processor
10	IRQ14	Primary IDE Channel
11	IRQ15	Secondary IDE Channel
12	IRQ3	Serial communication port 2
13	IRQ4	Serial communication port 1
14	IRQ5	Serial communication port 4
15	IRQ6	Available
16	IRQ7	Parallel port 1 (print port)

B.23 1st MB Memory Map

Table B.23: 1st MB Memory Map

Addr. range (Hex)	Device
E0000h - FFFFFh	BIOS
CC000h - DFFFFh	Unused
C0000h - CBFFFh	VGA BIOS
A0000h - BFFFFh	Video Memory
00000h - 9FFFFh	Base memory

ADVANTECH

Enabling an Intelligent Planet

www.advantech.com

Please verify specifications before quoting. This guide is intended for reference purposes only.

All product specifications are subject to change without notice.

No part of this publication may be reproduced in any form or by any means, electronic, photocopying, recording or otherwise, without prior written permission of the publisher.

All brand and product names are trademarks or registered trademarks of their respective companies.

© Advantech Co., Ltd. 2011